

» Kontron User's Guide «

Advanced TCA®



AM450x

Document Revision 3.2
December 2009

Revision History

Rev. Index	Brief Description of Changes	Date of Issue
3.2	New Template Release	December 2009

Customer Service

Contact Information:

Kontron Canada, Inc.

4555 Ambroise-Lafortune
Boisbriand, Québec, Canada
J7H 0A4
Tel: (450) 437-5682
(800) 354-4223
Fax: (450) 437-8053
E-mail: support@ca.kontron.com

Kontron Modular Computer GMBH

Sudetenstrasse 7
87600 Kaufbeuren
Germany
+49 (0) 8341 803 333
+49 (0) 8341 803 339
support-kom@kontron.com

Visit our site at: www.kontron.com

© 2009 Kontron, an International Corporation. All rights reserved.

The information in this user's guide is provided for reference only. Kontron does not assume any liability arising out of the application or use of the information or products described herein. This user's guide may contain or reference information and products protected by copyrights or patents and does not convey any license under the patent rights of Kontron, nor the rights of others.

Kontron is a registered trademark of Kontron. All trademarks, registered trademarks, and trade names used in this user's guide are the property of their respective owners. All rights reserved. Printed in Canada. This user's guide contains information proprietary to Kontron. Customers may reprint and use this user's guide in other publications. Customers may alter this user's guide and publish it only after they remove the Kontron name, cover, and logo.

Kontron reserves the right to make changes without notice in product or component design as warranted by evolution in user needs or progress in engineering or manufacturing technology. Changes that affect the operation of the unit will be documented in the next revision of this user's guide.

Table of Contents

<i>Safety Instructions</i>	2
Before You Begin	2
Preventing Electrostatic Discharge	3
<i>Preface</i>	4
How to Use This Guide	4
Customer Comments	4
Storing Boards	4
Advisory Conventions	5
Unpacking	5
Regulatory Compliance Statements	6
Limited Warranty	7
1. Product Description	1
1.1 Product Overview	1
1.2 What's Included	1
1.3 Board Specifications	2
1.4 Compliance	3
1.5 Hot-Swap Capability	3
2. Board Features	4
2.1 Block Diagram	4
2.2 SATA Switching	4
2.3 Redundant MMC Flash & FWUM	4
2.4 Hardware Management Overview	5
2.4.1 Sensor Data Record (SDR)	5
2.4.2 Hardware Sensors	6
2.4.3 Field Replaceable Unit (FRU) Information	7
2.4.4 E-Keying	8
2.4.5 MMC Firmware Code	8
2.4.6 MMC & FWUM Firmware Upgrade Procedure	8
2.5 AMC LEDs Signification	10
2.5.1 Hot Swap (Blue)	10
2.5.2 Out of service (Red/Amber)[default : red]	10
2.5.3 Health Led & HDD Activity (Amber/Green)[default : green]	10

3.	<i>Installing the Board</i>	11
3.1	Setting Jumpers	11
3.1.1	Jumper Description	11
3.1.2	Setting Jumpers & Locations	11
3.2	Onboard Interconnectivity	12
3.2.1	Onboard Connectors and Headers.....	12
3.3	Board Hot Swap and Installation	12
3.3.1	Installing an AMC	12
3.3.2	Removing an AMC	12
A.	<i>Connector Pinouts</i>	A-1
A.1	Connectors and Headers Summary	A-1
A.2	AMC (J4)	A-1
A.3	Serial ATA (J5).....	A-2
B.	<i>Getting Help</i>	B-1
B.1	Returning Defective Merchandise.....	2
B.2	When Returning a Unit	B-3
C.	<i>Glossary</i>	C-1

List of Figures

Figure 2-1: Block Diagram	4
Figure 2-2: Temperature Sensors Locations	7
Figure 3-1: Jumper Settings	11

List of Tables

Table 1-1	Board Specifications.....	2
Table 2-1	Hardware Sensors.....	6
Table 2-2	Hot Swap LED Descriptions.....	9
Table 3-1	Jumper Description.....	11
Table 3-2	Onboard Connectors and Headers.....	12

Safety Instructions

Before You Begin

Before handling the board, read the instructions and safety guidelines on the following pages to prevent damage to the product and to ensure your own personal safety. Refer to the "Advisories" section in the Preface for advisory conventions used in this user's guide, including the distinction between Warnings, Cautions, Important Notes, and Notes.

- Always use caution when handling/operating the computer. Only qualified, experienced, authorized electronics service personnel should access the interior of the computer. The power supplies produce high voltages and energy hazards, which can cause bodily harm.
- Use extreme caution when installing or removing components. Refer to the installation instructions in this user's guide for precautions and procedures. If you have any questions, please contact Kontron Technical Support



WARNING



High voltages are present inside the chassis when the unit's power cord is plugged into an electrical outlet. Turn off system power, turn off the power supply, and then disconnect the power cord from its source before removing the chassis cover. Turning off the system power switch does not remove power to components.

Preventing Electrostatic Discharge

Static electricity can harm system boards. Perform service at an ESD workstation and follow proper ESD procedure to reduce the risk of damage to components. Kontron strongly encourages you to follow proper ESD procedure, which can include wrist straps and smocks, when servicing equipment.

Take the following steps to prevent damage from electrostatic discharge (ESD):

- When unpacking a static-sensitive component from its shipping carton, do not remove the component's antistatic packing material until you are ready to install the component in a computer. Just before unwrapping the antistatic packaging, be sure you are at an ESD workstation or grounded. This will discharge any static electricity that may have built up in your body.
- When transporting a sensitive component, first place it in an antistatic container or packaging.
- Handle all sensitive components at an ESD workstation. If possible, use antistatic floor pads and workbench pads.
- Handle components and boards with care. Don't touch the components or contacts on a board. Hold a board by its edges or by its metal mounting bracket.
- Do not handle or store system boards near strong electrostatic, electromagnetic, magnetic, or radioactive fields.

Preface

How to Use This Guide

This user's guide is designed to be used as step-by-step instructions for installation, and as a reference for operation, troubleshooting, and upgrades.

You can find the latest release of this User's Guide at:

<http://www.kontron.com> or at: <ftp://ftp.kontron.ca/support/>

For the circuits, descriptions and tables indicated, Kontron assumes no responsibility as far as patents or other rights of third parties are concerned.

The following is a summary of chapter contents:

- Chapter 1, Product Description
- Chapter 2, Board Features
- Chapter 3, Installing the board
- Appendix A, Connector Pinout
- Appendix B, Getting Help
- Appendix C, Glossary

Customer Comments









If you have any difficulties using this user's guide, discover an error, or just want to provide some feedback, please send a message to: Tech.Writer@ca.kontron.com. Detail any errors you find. We will correct the errors or problems as soon as possible and post the revised user's guide on our Web site.

Storing Boards

Electronic boards are sensitive devices. Do not handle or store device near strong electrostatic, electromagnetic, magnetic or radioactive fields.

Advisory Conventions

Seven types of advisories are used throughout the user guides to provide helpful information or to alert you to the potential for hardware damage or personal injury. They are Note, Signal Paths, Related Jumpers, BIOS Settings, Software Usage, Cautions, and Warnings. The following is an example of each type of advisory. Use caution when servicing electrical components.

	Note: Indicate information that is important for you to know.	
	Signal Path: Indicate the places where you can find the signal on the board.	
	Jumper Settings: Indicate the jumpers that are related to this sections.	
	BIOS Settings: Indicate where you can set this option in the BIOS.	
	Software Usage: Indicates how you can access this feature through software.	
	CAUTION Indicate potential damage to hardware and tells you how to avoid the problem.	
	WARNING Indicates potential for bodily harm and tells you how to avoid the problem.	

Disclaimer: We have tried to identify all situations that may pose a warning or a caution condition in this user's guide. However, Kontron does not claim to have covered all situations that might require the use of a Caution or a Warning.

Unpacking

Follow these recommendations while unpacking:

- Remove all items from the box. If any items listed on the purchase order are missing, notify Kontron customer service immediately.
- Inspect the product for damage. If there is damage, notify Kontron customer service immediately.
- Save the box and packing material for possible future shipment.

Regulatory Compliance Statements

FCC Compliance Statement for Class B Devices

This equipment has been tested and found to comply with the limits for a Class B digital device, pursuant to Part 15 of the FCC Rules. These limits are designed to provide reasonable protection against harmful interference in a residential installation. This equipment generated, uses and can radiate radio frequency energy and, if not installed and used in accordance with the instructions may cause harmful interference to radio communications. However, there is no guarantee that interference will not occur in a particular installation. If this equipment does cause harmful interference to radio or television reception, which can be determined by turning the equipment off and on, the user is encouraged to try to correct the interference by one or more of the following measures:

- Reorient or relocate the receiving antenna.
- Increase the separation between the equipment and receiver.
- Connect the equipment into an outlet on a circuit different from that to which the receiver is connected.
- Consult the dealer or an experience radio/TV technician for help.



WARNING

This is a Class B product. If not installed in a properly shielded enclosure and used in accordance with this User's Guide, this product may cause radio interference in which case users may need to take additional measures at their own expense.



Safety Certification

All Kontron equipment meets or exceeds safety requirements based on the IEC/EN/UL/CSA 60950-1 family of standards entitled, "Safety of information technology equipment." All components are chosen to reduce fire hazards and provide insulation and protection where necessary. Testing and reports when required are performed under the international IECCE CB Scheme. Please consult the "Kontron Safety Conformity Policy Guide" for more information.

CE Certification

The product described in this user's guide was tested in a representative system and is found to be compliant with the CE marking requirements. For computer systems to remain CE compliant, only CE-compliant parts may be used. Maintaining CE compliance also requires proper cable and cabling techniques. Although Kontron offers accessories, the customer must ensure that these products are installed with proper shielding to maintain CE compliance. Kontron does not offer engineering services for designing cabling systems. In addition, Kontron will not retest or recertify systems or components that have been reconfigured by customers.

Limited Warranty

Kontron grants the original purchaser of Kontron's products a TWO YEAR LIMITED HARDWARE WARRANTY as described in the following. However, no other warranties that may be granted or implied by anyone on behalf of Kontron are valid unless the consumer has the express written consent of Kontron.

Kontron warrants their own products, excluding software, to be free from manufacturing and material defects for a period of 24 consecutive months from the date of purchase. This warranty is not transferable nor extendible to cover any other users or long-term storage of the product. It does not cover products which have been modified, altered or repaired by any other party than Kontron or their authorized agents. Furthermore, any product which has been, or is suspected of being damaged as a result of negligence, improper use, incorrect handling, servicing or maintenance, or which has been damaged as a result of excessive current/voltage or temperature, or which has had its serial number(s), any other markings or parts thereof altered, defaced or removed will also be excluded from this warranty.

If the customer's eligibility for warranty has not been voided, in the event of any claim, he may return the product at the earliest possible convenience to the original place of purchase, together with a copy of the original document of purchase, a full description of the application the product is used on and a description of the defect. Pack the product in such a way as to ensure safe transportation (see our safety instructions).

Kontron provides for repair or replacement of any part, assembly or sub-assembly at their own discretion, or to refund the original cost of purchase, if appropriate. In the event of repair, refunding or replacement of any part, the ownership of the removed or replaced parts reverts to Kontron, and the remaining part of the original guarantee, or any new guarantee to cover the repaired or replaced items, will be transferred to cover the new or repaired items. Any extensions to the original guarantee are considered gestures of goodwill, and will be defined in the "Repair Report" issued by Kontron with the repaired or replaced item.

Kontron will not accept liability for any further claims resulting directly or indirectly from any warranty claim, other than the above specified repair, replacement or refunding. In particular, all claims for damage to any system or process in which the product was employed, or any loss incurred as a result of the product not functioning at any given time, are excluded. The extent of Kontron liability to the customer shall not exceed the original purchase price of the item for which the claim exists.

Kontron issues no warranty or representation, either explicit or implicit, with respect to its products' reliability, fitness, quality, marketability or ability to fulfil any particular application or purpose. As a result, the products are sold "as is," and the responsibility to ensure their suitability for any given task remains that of the purchaser. In no event will Kontron be liable for direct, indirect or consequential damages resulting from the use of our hardware or software products, or documentation, even if Kontron were advised of the possibility of such claims prior to the purchase of the product or during any period since the date of its purchase.

Please remember that no Kontron employee, dealer or agent is authorized to make any modification or addition to the above specified terms, either verbally or in any other form, written or electronically transmitted, without the company's consent.

1. Product Description

1.1 Product Overview

AdvancedMC modules are the key to extending the value of AdvancedTCA platforms designed for multiple applications in the wireless / wireline network infrastructure.

As the ideal low-cost storage solution for open modular communications solutions, the Kontron AM450x SATA module is available in full -size and mid-size, single width form factors, and offers up to 120 GByte storage capacity. Built in accordance to the AMC.0 specification, the AM450x is also AMC.3 compliant, features Native Command Queuing (NCQ) with up to 32 instructions to be queued and reordered, and is easily managed via IPMI v1.5.

As a hot-swappable field replaceable unit (FRU), the AM450x also follows the same stringent carrier grade RASM feature set, namely - Reliability, Availability, Serviceability, Maintainability. When offered in combination with AdvancedTCA platforms, TEM (Telecom Equipment Manufacturers) clients literally save valuable system slots.

1.2 What's Included

This board is shipped with the following items:

- One Quick Reference Sheet.
- One CD-ROM containing documentation and drivers.
- One AM450x board

If any item is missing or damaged, contact the supplier.

1.3 Board Specifications

Table 1-1: Board Specifications

Features	Description
Compliance	<ul style="list-style-type: none"> AMC.0 R2.0 AMC.3 R1.0
OS Compatibility	<ul style="list-style-type: none"> RedHat Linux Enterprise 4
IPMI Features	<ul style="list-style-type: none"> Management Controller compliant to PICMG 3.0, AMC.0 R2.0 and IPMI v1.5 rev 1.1. Management Controller is run time field reprogrammable without payload impact. Robust fail safe reprogramming implementation (which includes two firmware images) that could perform automatic or manual rollback if a problem occurs during critical reprogramming phase. Remote upgrade capability from IPMI interface (via IPMB-L). Management Controller self test which can detect failure under its code integrity and trig an automatic rollback.
Supervisory	<ul style="list-style-type: none"> Hardware system monitor through IPMI (voltages, currents, temperature), temperature monitor / alarm; board temperature sensor, power failure.
Mechanical	<ul style="list-style-type: none"> Single-width Full-Size (181.5 x 75 x 30.16 mm) or mid-size (181.5 x 75 x 18.96 mm)
Power Requirements	<ul style="list-style-type: none"> Management power is less than 100mA peak at 3.3V Payload power is drive dependant
Environmental Temperature*	<ul style="list-style-type: none"> Operating: 0-40°C/32-104°F (AM4500) 0-55°C/32-131°F (AM4501) Storage and Transit: -40 to +70°C/-40 to 158°F
Environmental Humidity*	<ul style="list-style-type: none"> Operating: 15% to 90% @55°C/131°F non-condensing Storage and Transit: 5% to 95% @ 40°C/104°F non-condensing
Environmental Altitude*	<ul style="list-style-type: none"> Operating: 4,000 m / 13,123 ft Storage and Transit: 15,000 m / 49,212 ft
Environmental Shock*	<ul style="list-style-type: none"> Operating: 30G, half-sine 11ms, each axis Storage and Transit: Bellcore GR-63-CORE Section 4.3
Environmental Vibration*	<ul style="list-style-type: none"> Operating: 1.0G, 5-500Hz each axis Storage and Transit: 0.5G, 5-50Hz; 3.0G, 50-500Hz each axis
Reliability	<ul style="list-style-type: none"> MTBF: > 1 008 000 hours @ 40 C / 104 F (Telcordia SR-332, Issue 1) No Hard Disk
Safety / EMC	<p>Meet or exceed:</p> <ul style="list-style-type: none"> Safety: UL 60950-1; CSA C22.2 No 60950-1-03; EN 60950-1:2001; IEC60950-1 EMI/EMC: FCC 47 CFR Part 15, Class B; CE Mark to EN55022/EN55024/EN300386
Warranty	<ul style="list-style-type: none"> Two years limited warranty

* Designed to meet or exceed

1.4 Compliance

This product conforms to the following specifications:

- PICMG3.0R2.0 (Advanced TCA core specification)
- AMC.0 R2.0 (Advanced mezzanine card base specification)
- AMC.3 R1.0 (Advanced mezzanine card storage)
- IPMI rev 1.5
- Serial-ATA 1.0a

1.5 Hot-Swap Capability

The AM450x supports Full Hot Swap capability as per PICMG3.0R2.0. It can be removed from or installed in the system while it is on (without powering-down the system). Please refer to the PICMG3.0R2.0 specification for additional details. (OS must support drive hot swap)

2. Board Features

2.1 Block Diagram

Figure 2-1: Block Diagram

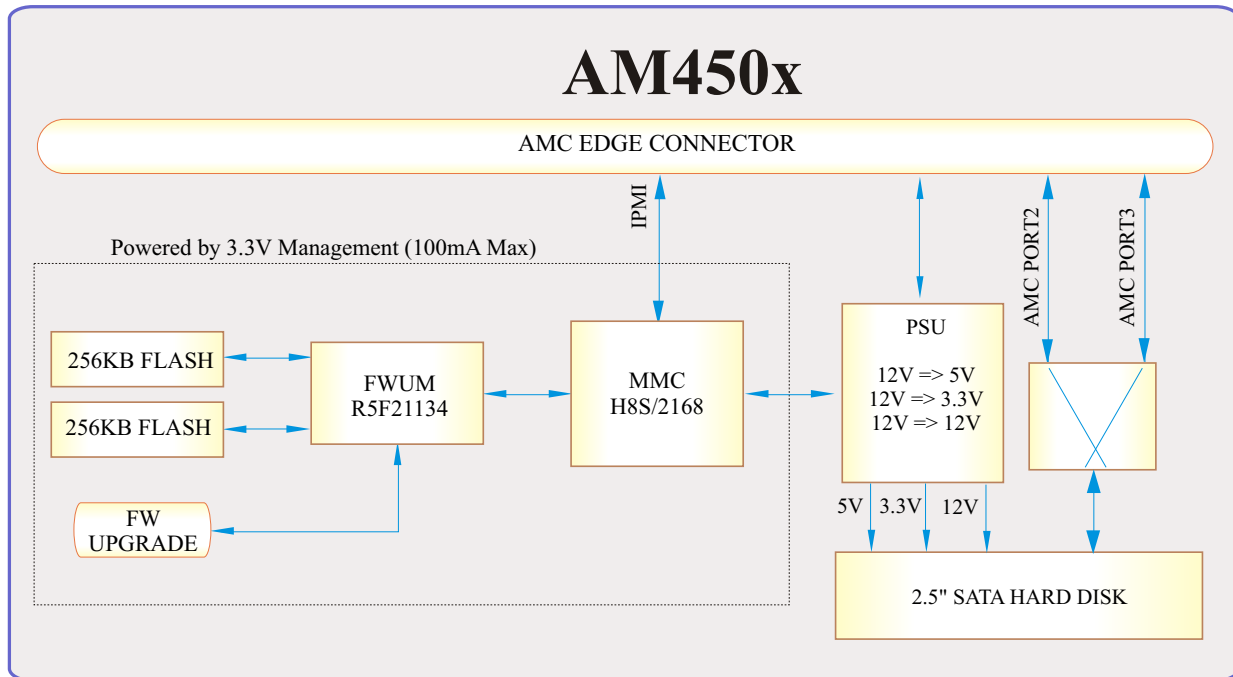

2.2 SATA Switching

The AM450x features a SATA switching port device which enables the system to interconnect AMC port 2 or 3 to SATA drive port 0, which can be set automatically by the MMC. This makes it possible to design redundant storage configurations for MicroTCA open modular platforms.

2.3 Redundant MMC Flash & FWUM

The MMC microcontroller runs a firmware from its internal 256KB flash. It is programmed by another microcontroller named FWUM (FirmWare Update Manager). The FWUM keeps the last two copies of the MMC firmware in dedicated flash memories. The FWUM act as a watchdog to the MMC and can rollback a firmware update in the MMC in case of problems.

The FWUM itself is a microcontroller with internal flash to store MMC firmware image. Functions of this microncontroller is kept to a minimum. The FWUM firmware is field updatable.



Note:

The MMC and the FWUM have an internal hardware watchdog.

2.4 Hardware Management Overview

The AMC Carrier communicates with the Module Management Controller (MMC) using the IPMB-L channel.

The memory subsystem of the MMC consists of an integrated flash memory to hold the MMC operation code and integrated RAM for data. The field replacement unit (FRU) inventory information is stored in the non volatile memory on an EEPROM connected via a local I2C interface to the MMC microcontroller. It is possible to store up to 4 KBytes within the FRU inventory information. Event generation over IPMB-L bus to reach the AMC Carrier that forward it to the ShMc ensure that 'post-mortem' logging information is available even if the power of the AMC is disabled.

The onboard DC voltages and temperature are monitored by the MMC device. The MMC will send an event to the Carrier AMC if any of the thresholds are exceeded.

To increase the reliability of the SBC management subsystem, an external watchdog supervisor only for the MMC is implemented. The MMC must strobe the external FWUM watchdog to ensure continuity of operation of the board's management subsystem. The watchdog supervisor does not reset the payload power and the restart of the MMC will not affect the payload and will restore the previous Module Hot Swap state. The external watchdog supervisor is not configurable and must not be confused with the IPMI v1.5 watchdog timer commands.

2.4.1 Sensor Data Record (SDR)

Every sensor on the AMC board is associated with a Sensor Data Record (SDR). Sensor Data Records contain information about the sensors identification such as sensor type, sensor name, sensor unit. SDR also contain the configuration of a specific sensor such as threshold/hysteresis, event generation capabilities that specifies sensor behavior. Some field of the sensor SDR are configurable through IPMI v1.5 command and are set to built-in initial value. Finally one field which is the sensor owner must reflect the module addresses that allow the AMC Carrier to identify the owner of the SDR when it is scanned from the module management controller and merged within the AMC Carrier Device SDR repository.

From IPMI perspective, the AMC management controller is set up as a satellite management controller (SMC). It does support sensor devices, and use the IPMI static sensor population feature of IPMI v1.5. The usual way the AMC Carrier is informed about an AMC insertion is through the AMC Module Hot Swap sensor via IPMB-L event. All SDRs can be queried using Device SDR commands to the firmware. Module sensors that have been implemented are listed below.

2.4.2 Hardware Sensors

Table 2-1: Hardware Sensors

Sensor Name	Voltage/Signals Monitored	Scanning Enabled under Power State	Health LED (Green to Amber)
IPMI Info-1	Internal IPMC firmware diagnostic	Power On/Off	No change
IPMI Info-2	Internal IPMC firmware diagnostic	Power On/Off	No change
FRU Agent	Board FRU DATA agent that verify Data validity	Power On/Off	No change
AMC Stor Err	Management sub-system health; non volatile memory error.	Power On/Off	No change
Board 3.3V	3.3V	Power On	Exceeds critical threshold
Board 5V	+5 V	Power On	Exceeds critical threshold
Board 12v	+12 V	Power On	Exceeds critical threshold
Board 12V Drv	+ 12V Hard Drive	Power On	Exceeds critical threshold
Board 3.3VSUS	+3.3 VSB	Power On/Off	Exceeds critical threshold
Board BlueLed	Blue LED Voltage	Power On/Off	Exceeds critical threshold
ModuleHotSwap	AMC HS State	Power On/Off	No change
IPMBL State	Operational state of IPMB-L	Power On/Off	No change
Health Error	Aggregation of healthy related sensor	Power On/Off	Asserted/deasserted
Temp AirInlet	Board Inlet Temperature (See note below)	Power On/Off	Exceeds critical threshold
Temp Exhaust	Board Outlet Temperature (See note below)	Power On/Off	Exceeds critical threshold
Temp PSU In	Power Switcher In Temperature (See note below)	Power On/Off	Exceeds critical threshold
Temp PSU Out	Power Switcher Out Temperature (See note below)	Power On/Off	Exceeds critical threshold
MMCreboot	IPMC reboot detection	Power On/Off	No change
Ver change	IPMC firmware upgrade detection	Power On/Off	No change



Note:

Temperature sensors thresholds are programmed depending on the hard disk configuration.

2.4.2.1 IPMB-L Link Sensor

The AM450x has an IPMB-L link to communicate with the AMC Carrier and other chassis devices on the chassis IPMB-0 bus. MMC monitors the bus for any link failure and send the bus failure event to the AMC Carrier upon recovery.

2.4.2.2 Module Hot Swap

The hot-swap event message conveys the current state of the module, the previous state, and a cause of the state change as determined by the MMC. Refer to AMC.0 R2.0 Specifications for further details on the module hot-swap state.

2.4.2.3 Temperature Sensors Locations

Figure 2-2: Temperature Sensors Locations

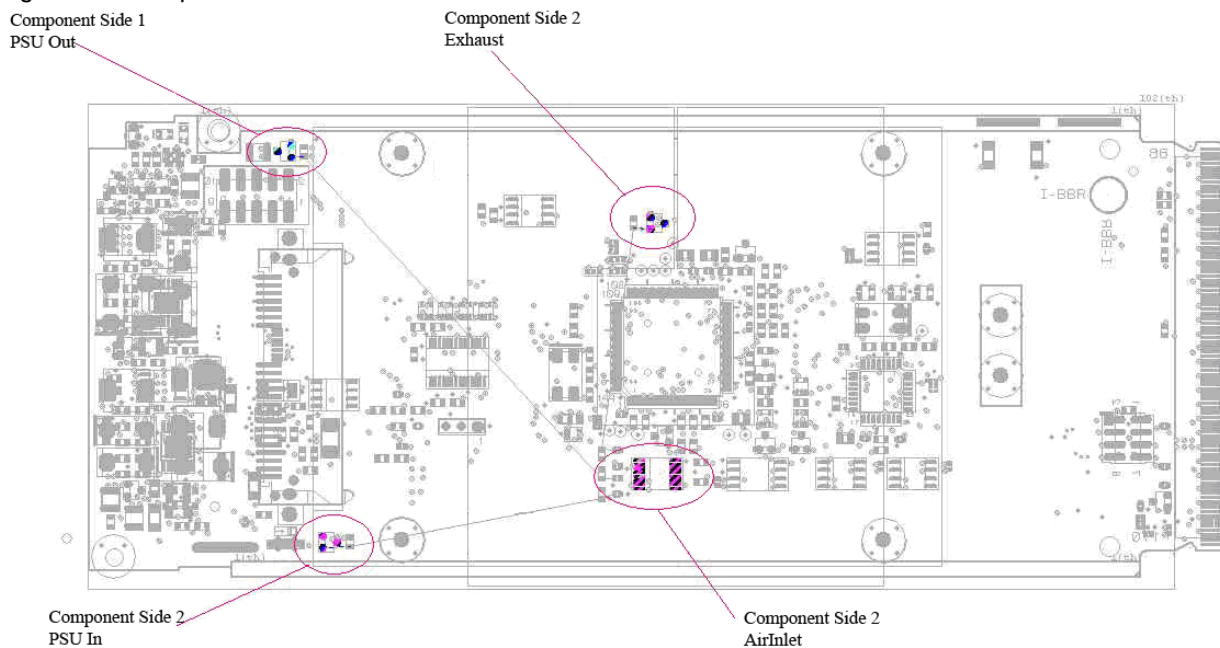

Note:

Component Side 2 is on the Hard disk side



Note:

Temperature values are provided for reference only; they should not be used for system calibration.

2.4.3 Field Replaceable Unit (FRU) Information

The FRU Information provides inventory data about the board where the FRU Information Device is located. The part number or version number can be read through software.

FRU information in the AM450x includes data describing the AM450x board as per AMC.0 R2.0 specification requirements. This information is retrieved by the Carrier AMC, enabling reporting of board-specific information through a standardized mechanism.

Following are the definitions for the multirecord implemented by the firmware as part of Module data.

2.4.4 E-Keying

E-Keying has been defined in the AMC.0 R2.0 Specification to prevent module damage, prevent misoperation, and verify bay connection compatibility. The FRU data contains the AMC point-to-point connectivity record as described in Section 3.9.1 of the AMC.0 R2.0 specification.

The Set/Get AMC Port State IPMI commands defined by the AMC.0 specification are used for either granting or rejecting the E-keys.

2.4.5 MMC Firmware Code

MMC firmware code is organized into boot code and operational code, both of which are stored in a flash module. Upon an MMC reset, the MMC executes the boot code and performs the following:

- 1 Self test to verify the status of its hardware and memory.
- 2 Performs a checksum of the operational code.
- 3 Communicates with the Firmware Upgrade Manager (FWUM) in order to inform the MMC watchdog that the actual MMC firmware is suitable for execution.

Upon successful verification of the operational code checksum, the firmware will jump to the operational code.

2.4.6 MMC & FWUM Firmware Upgrade Procedure

It is important to use compatible, MMC, FWUM versions. Since all these software and hardware solutions are exchanging information, they must be in synch. Please always follow Kontron documentation for all your upgrades.

The recommended upgrade sequence must be: FWUM, MMC,.

MMC Firmware upgrades can be done by using IPMITOOL from the AMC Carrier or remotely on the chassis. It has been designed to be upgraded through any IPMI interface without payload impact

FWUM upgrade should not be required since its functionality is very specific. However, FWUM Firmware upgrade is done using IPMIFWU utility. This is a Linux utility developed by Kontron that use the serial port of any computer to exchange with the FirmWare Upgrade Manager (FWUM) in order to upgrade the FWUM or the MMC firmware. This tool doesn't need the KCS driver to run over the Carrier AMC (it doesn't use the IPMI interfaces) but requires a serial cable hook on the AMC module.

Type the following to perform MMC firmware upgrade

```
ipmifwu -p -f <FWUM_firmware_filename> -m -p /dev/ttyS0 -S<enter>
```



Note:

The tool is available on request. Please contact Technical Support for cable instructions.



WARNING

During FWUM firmware upgrade the MMC is held in reset. A firmware upgrade might have a payload impact.



2.4.6.1 Hot-Swap Process

The AM450x AMC has the ability to be hot-swapped in and out of a AMC Carrier. The onboard MMC manages the AMC's power-up and power-down transitions. The list below illustrates this process for power down request.

- 1 Ejector latch is opened. HOT_SWAP_PB# assertion. MMC firmware detects the assertion of this signal.
- 2 MMC sends "Module Handle Open" event message to AMC Carrier. The corresponding M state of AMC Carrier moves from M4-> M5.
- 3 AMC Carrier moves from M5 -> M6 if the SHMC grants the request and then send the FRU Control requesting quiesced state to the AMC.
- 4 The firmware deasserts payload power and sends "Module Quiesced" event message to the AMC Carrier where it transitions from M6 to M1 state.

2.4.6.2 Hot-Swap LED

The AM450x supports a blue Hot Swap LED mounted on the front panel. This LED indicates when it is safe to remove the AMC from the AMC Carrier. The on-board MMC drives this LED to indicate the hot-swap state. The following states are possible:

Table 2-2: Hot Swap LED Descriptions

LED state	Description
OFF	AMC is in M4 state, normal state when board is in operation.
ON	Ready for hot swap.
Short blink	M5 state deactivation request. Indicates deactivation is in progress.
Long blink	M2 state Activation Request. Indicates activation is in progress.

When the AMC latch is disengaged from the faceplate, the hot swap switch embedded in the PCB will assert a "HOT_SWAP_PB#" signal to the MMC, and the MMC will send "Module Handle Open" event message to the AMC Carrier which move from the M4 state to the M5 state. At the M5 state, the AMC Carrier will ask the SHMC (or Shelf Manager) for permission to move the AMC to the M6 state. Then the Carrier AMC will set the AMC Hot Swap LED to indicate this state with a short blink. Once permission is received from the SHMC or higher-level software, the AMC will move to the M6 state.

The SHMC or higher level software can reject the request to move to the M6 state. If this occurs, the AMC will return the Hot Swap LED to a solid off condition, indicating that the AMC has returned to M4 state.

If the AMC reaches the M6 state through an extraction request through the AMC handle latch, the MMC communicates to the AMC Carrier that the module must discontinue operation in preparation for removal. The Hot Swap LED continues to flash during this preparation time, just like it does at the M5 state. When main AMC payload power is successfully removed from the AMC Bay, the Hot Swap LED remains lit, indicating it is safe to remove the AMC from the AMC Carrier.

2.5 AMC LEDs Signification

2.5.1 Hot Swap (Blue)

Solid On	(100 % on):	FRU Inactive
Long Blink	(90 % on):	FRU Activation Request / FRU Activation In Progress
Solid Off	(0 % on):	FRU Active
Short Blink	(10 % on):	FRU Deactivation Request / FRU Deactivation In Progress

2.5.2 Out of service (Red/Amber) [default : red]

Solid On:	IPMC in reset
Fast Blink (~50 % on):	IPMC upgrade/rollback in progress
Short Blink (10 % on):	FRU Power Denied
Application Defined:	May be controlled by application using PICMG API

2.5.3 Health Led & HDD Activity (Amber/Green) [default : green]

Green:	Health Ok
Amber:	Health Error (Critical) / Payload power down or in reset
Application Defined:	May be controlled by application using PICMG API
Blink:	HDD Activity

3. Installing the Board

3.1 Setting Jumpers

3.1.1 Jumper Description

Table 3-1: Jumper Description

Description	
Reserved	W1 1-2
Reserved	W1 3-4
Reserved	W1 5-6
Reserved	W1 7-8

3.1.2 Setting Jumpers & Locations

Figure 3-1: Jumper Settings

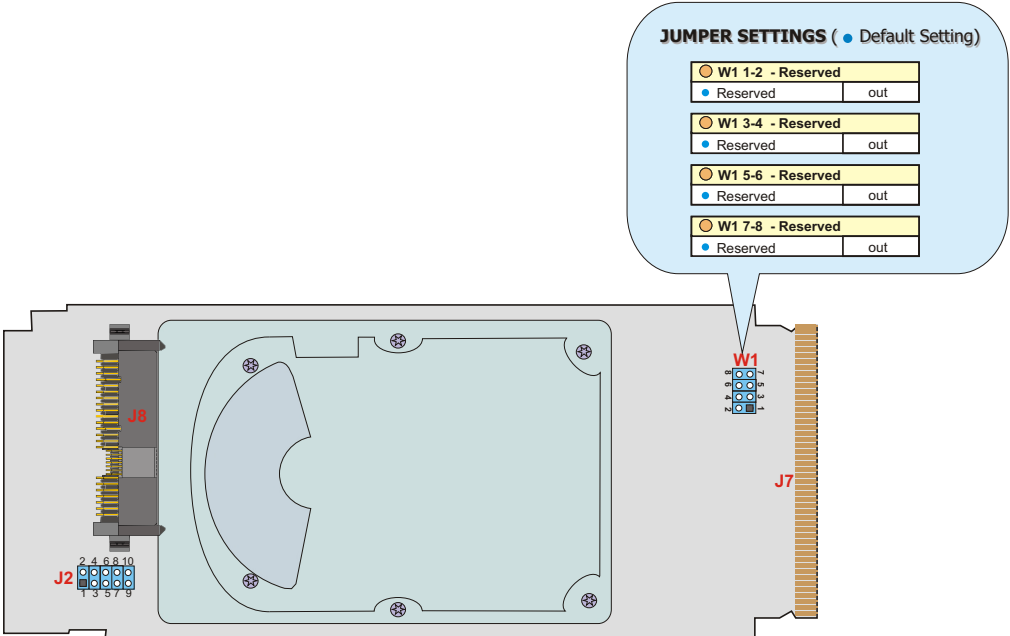

3.2 Onboard Interconnectivity

3.2.1 Onboard Connectors and Headers

Table 3-2: Onboard Connectors and Headers

Description	Connector	Comments
AMC Connector	J4	AMC Connector
SATA Connector	J5	Serial ATA Connector

3.3 Board Hot Swap and Installation

Some precautions must be taken when connecting or disconnecting a board to:

- 1 Rail guides must be installed on the enclosure to slide the board to the backplane.
- 2 Do not force the board if there is mechanical resistance while inserting the board.
- 3 Use extractor handle to disconnect and extract the board from its enclosure.



WARNING

Always use a grounding wrist wrap before installing or removing the board from a chassis.



3.3.1 Installing an AMC

To install an AMC:

- 1 Remove the AMC filler panel.
- 2 Carefully engage the AMC into the card guide. Push the AMC until it fully mate with it's connector. Secure the AMC handle to the locking position.
- 3 In normal condition, the blue LED shall turn ON as soon as the AMC is fully inserted. It will turn OFF at the end of the hot swap sequence.

3.3.2 Removing an AMC

To remove an AMC:

- 1 Open the AMC handle.
- 2 The blue LED will start blinking; wait until it is solid blue.
- 3 Extract the AMC by pulling it out with the handle.



Note:

Ensure that your OS is Hot Plug compliant before removing your AMC.

A. Connector Pinouts

A.1 Connectors and Headers Summary

Connector	Description
J4	AMC
J5	Serial ATA Connector

A.2 AMC (J4)

Pin	Signal	Pin	Signal	Pin	Signal	Pin	Signal
B1	GND	B43	GND	B86	GND	B129	RxD15-(N.C.)
B2	12V	B44	TxD4+(N.C.)	B87	RxD8-(N.C.)	B130	RxD15+(N.C.)
B3	PS1#	B45	TxD4-(N.C.)	B88	RxD8+(N.C.)	B131	GND
B4	MP_3V3	B46	GND	B89	GND	B132	TxD15-(N.C.)
B5	GA0	B47	RxD4+(N.C.)	B90	TxD8-(N.C.)	B133	TxD15+(N.C.)
B6	N.C.	B48	RxD4-(N.C.)	B91	TxD8+(N.C.)	B134	GND
B7	GND	B49	GND	B92	GND	B135	RxD16-(N.C.)
B8	N.C.	B50	TxD5+(N.C.)	B93	RxD9-(N.C.)	B136	RxD16+(N.C.)
B9	12V	B51	TxD5-(N.C.)	B94	RxD9+(N.C.)	B137	GND
B10	GND	B52	GND	B95	GND	B138	TxD16-(N.C.)
B11	TxD0+ (N.C.)	B53	RxD5+(N.C.)	B96	TxD9-(N.C.)	B139	TxD16+(N.C.)
B12	TxD0- (N.C.)	B54	RxD5-(N.C.)	B97	TxD9+(N.C.)	B140	GND
B13	GND	B55	GND	B98	GND	B141	RxD17- (N.C.)
B14	RxD0+ (N.C.)	B56	IPMI_CLK	B99	RxD10-(N.C.)	B142	RxD17+ (N.C.)
B15	RxD0- (N.C.)	B57	12V	B100	RxD10+(N.C.)	B143	GND
B16	GND	B58	GND	B101	GND	B144	TxD17- (N.C.)
B17	GA1	B59	TxD6+(N.C.)	B102	TxD10-(N.C.)	B145	TxD17+ (N.C.)
B18	12V	B60	TxD6-(N.C.)	B103	TxD10+(N.C.)	B146	GND
B19	GND	B61	GND	B104	GND	B147	RxD18- (N.C.)
B20	TxD1+ (N.C.)	B62	RxD6+(N.C.)	B105	RxD11-(N.C.)	B148	RxD18+ (N.C.)
B21	TxD1- (N.C.)	B63	RxD6-(N.C.)	B106	RxD11+(N.C.)	B149	GND
B22	GND	B64	GND	B107	GND	B150	TxD18- (N.C.)
B23	RxD1+ (N.C.)	B65	TxD7+(N.C.)	B108	TxD11-(N.C.)	B151	TxD18+ (N.C.)
B24	RxD1- (N.C.)	B66	TxD7-(N.C.)	B109	TxD11+(N.C.)	B152	GND
B25	GND	B67	GND	B110	GND	B153	RxD19- (N.C.)
B26	GA2	B68	RxD7+(N.C.)	B111	RxD12-(N.C.)	B154	RxD19+ (N.C.)
B27	12V	B69	RxD7-(N.C.)	B112	RxD12+(N.C.)	B155	GND
B28	GND	B70	GND	B113	GND	B156	RxD19- (N.C.)
B29	TxD2+(SATA)	B71	IPMI_DATA	B114	TxD12-(N.C.)	B157	TxD19+ (N.C.)
B30	TxD2-(SATA)	B72	12V	B115	TxD12+(N.C.)	B158	GND

Pin	Signal	Pin	Signal	Pin	Signal	Pin	Signal
B31	GND	B73	GND	B116	GND	B159	RxD20- (N.C.)
B32	RxD2+(SATA)	B74	CLKA+(N.C.)	B117	RxD13-(N.C.)	B160	RxD20+ (N.C.)
B33	RxD2-(SATA)	B75	CLKA-(N.C.)	B118	RxD13+(N.C.)	B161	GND
B34	GND	B76	GND	B119	GND	B162	TxD20- (N.C.)
B35	TxD3+(N.C.)	B77	CLKB+(N.C.)	B120	TxD13-(N.C.)	B163	TxD20+ (N.C.)
B36	TxD3-(N.C.)	B78	CLKB-(N.C.)	B121	TxD13+(N.C.)	B164	GND
B37	GND	B79	GND	B122	GND	B165	TCLK
B38	RxD3+(N.C.)	B80	CLKC+(N.C.)	B123	RxD14-(N.C.)	B166	TMS
B39	RxD3-(N.C.)	B81	CLKC-(N.C.)	B124	RxD14+(N.C.)	B167	TRST#
B40	GND	B82	GND	B125	GND	B168	TDO
B41	ENABLE#	B83	PS0#	B126	TxD14-(N.C.)	B169	TDI
B42	12V	B84	12V	B127	TxD14+(N.C.)	B170	GND
		B85	GND	B128	GND		

A.3 Serial ATA (J5)

Pin	Signal	Pin	Signal
S1	GND	P1	3.3V
S2	TX+	P2	3.3V
S3	TX-	P3	3.3V
S4	GND	P4	GND
S5	RX-	P5	GND
S6	RX+	P6	GND
S7	GND	P7	5V
		P8	5V
		P9	5V
		P10	GND
		P11	RSV
		P12	GND
		P13	12V
		P14	12V
		P15	12V

B. Getting Help

If, at any time, you encounter difficulties with your application or with any of our products, or if you simply need guidance on system setups and capabilities, contact our Technical Support at:

North America

Tel.: (450) 437-5682

Fax: (450) 437-8053

EMEA

Tel.: +49 (0) 8341 803 333

Fax: +49 (0) 8341 803 339

If you have any questions about Kontron, our products, or services, visit our Web site at: www.kontron.com

You also can contact us by E-mail at:

North America: support@ca.kontron.com

EMEA: support-kom@kontron.com

Or at the following address:

North America

Kontron Canada, Inc.

4555, Ambroise-Lafortune

Boisbriand, Québec

J7H 0A4 Canada

EMEA

Kontron Modular Computers GmbH

Sudetenstrasse 7

87600 Kaufbeuren

Germany

B.1 Returning Defective Merchandise

Before returning any merchandise please do one of the following:

- Call
 - 1 Call our Technical Support department in North America at (450) 437-5682 and in EMEA at +49 (0) 8341 803 333. Make sure you have the following on hand: our Invoice #, your Purchase Order #, and the Serial Number of the defective unit.
 - 2 Provide the serial number found on the back of the unit and explain the nature of your problem to a service technician.
 - 3 The technician will instruct you on the return procedure if the problem cannot be solved over the telephone.
 - 4 Make sure you receive an RMA # from our Technical Support before returning any merchandise.

- E-mail
 - 1 Send us an e-mail at: RMA@ca.kontron.com in North America and at: orderprocessing@kontron-modular.com in EMEA. In the e-mail, you must include your name, your company name, your address, your city, your postal/zip code, your phone number, and your e-mail. You must also include the serial number of the defective product and a description of the problem.

B.2 When Returning a Unit

- In the box, you must include the name and telephone number of a contact person, in case further explanations are required. Where applicable, always include all duty papers and invoice(s) associated with the item(s) in question.
- Ensure that the unit is properly packed. Pack it in a rigid cardboard box.
- Clearly write or mark the RMA number on the outside of the package you are returning.
- Ship prepaid. We take care of insuring incoming units.

North America	EMEA
Kontron Canada, Inc.	Kontron Modular Computers GmbH
4555, Ambroise-Lafortune	Sudetenstrasse 7
Boisbriand, Québec	87600 Kaufbeuren
J7H 0A4 Canada	Germany

C. Glossary

Acronyms	Descriptions
AdvancedMC	(Same as AMC). Advanced Mezzanine Card.
AMC	(Same as AdvancedMC). Advanced Mezzanine Card.
AMC.0	Advanced Mezzanine Card Base Specification.
AMC.1	PCI Express and Advanced Switching on AdvancedMC. A subsidiary specification to the Advanced Mezzanine Card Base Specification (AMC.0).
AMC.2	Ethernet Advanced Mezzanine Card Specification. A subsidiary specification to the Advanced Mezzanine Card Base Specification (AMC.0).
AMC.3	Advanced Mezzanine Card Specification for Storage. A subsidiary specification to the Advanced Mezzanine Card Base Specification (AMC.0).
API	Application Programming Interface
ASCII	American Standard Code for Information Interchange. ASCII codes represent text in computers, communications equipment, and other devices that work with text.
ATA	Advanced Technology Attachment
ATAPI	Advanced Technology Attachment Packet Interface
ATCA	Advanced Telecommunications Computing Architecture
BI	Base Interface. Backplane connectivity defined by the ATCA.
BIOS	Basic Input/Output System
BMC	Base Management Controller
CFM	Cubic Foot per Minute
CLI	Command-Line Interface
CLK1	AdvancedTCA based resource Synch clock group 1
CLK1A	AdvancedTCA based resource Synch clock group 1, bus A
CLK1B	AdvancedTCA based resource Synch clock group 1, bus B
CLK2	AdvancedTCA based resource Synch clock group 2
CLK2A	AdvancedTCA based resource Synch clock group 2, bus A
CLK2B	AdvancedTCA based resource Synch clock group 2, bus B
CLK3	AdvancedTCA based resource Synch clock group 3
CLK3A	AdvancedTCA based resource Synch clock group 3, bus A
CLK3B	AdvancedTCA based resource Synch clock group 3, bus B
CMIC	CPU Management Interface Controller
CMOS	Complementary Metal Oxide Semiconductor. Also refers to the small amount of battery (or capacitor) powered CMOS memory to hold the date, time, and system setup parameters.
CPU	Central Processing Unit. This sometimes refers to a whole blade, not just a processor component.
CTCA	Compact Telecom Computing Architecture
DMA	Direct Memory Access
DMI	Desktop Management Interface
EEPROM	Electrically Erasable Programmable Read-Only Memory
EHCI	Enhanced Host Controller Interface. Specification for Universal Serial Bus specification, revision 2.0.
FPGA	Field-Programmable Gate Array
FRU	Field Replaceable Unit. Any entity that can be replaced by a user in the field. Not all FRUs are hot swappable.

Acronyms	Descriptions
FW	FirmWare
FWH	FirmWare Hub. Boot flash connected to the LPC bus containing BIOS FW.
Gb	Gigabit
GB	(Same as GByte) GigaByte.
GByte	(Same as GB) GigaByte.
GND	GrouND
HDD	Hard Disc Drive
HPM	PICMG Hardware Platform Management specification family
HPM.1	Hardware Platform Management IPM Controller Firmware Upgrade Specification
HW	HardWare
I2C	Inter Integrated Circuit bus
ICH	I/O Controller Hub
IPM	Intelligent Platform Management
IPMB	Intelligent Platform Management Bus
IPMB-0	Intelligent Platform Management Bus Channel 0, the logical aggregation of IPMB-A and IPMB-B.
IPMB-A	Intelligent Platform Management Bus A
IPMB-B	Intelligent Platform Management Bus B
IPMB-L	Intelligent Platform Management Bus Local
IPMC	Intelligent Platform Management Controller
IPMI	Intelligent Platform Management Interface
IPMIFWU	Intelligent Platform Management Interface FirmWare Update
JTAG	Joint Test Action Group
MTBF	Mean Time Between Failures
OOS	Out Of Service
OS	Operating System
PCB	Printed Circuit Board
PCI	Peripheral Component Interconnect
PCI-32	Peripheral Component Interconnect 32 bits
PCI®	Peripheral Component Interconnect
PCIe	(Same as PCI-E). PCI-Express. Next generation I/O standard
PCI-E	(Same as PCIe). PCI-Express. Next generation I/O standard.
PICMG	PCI Industrial Computer Manufacturers Group
PICMG®	PCI Industrial Computer Manufacturers Group
RAID	Redundant Array of Independent Disks / Redundant Array of Inexpensive Disks.
RHEL	Red Hat Enterprise Linux
RoHS	Restriction of the Use of Certain Hazardous Substances
S.M.A.R.T.	Self-Monitoring, Analysis, and Reporting Technology for IDE.
SAS	Serial Attached SCSI
SATA	Serial ATA
SSD	Solid State Drive