

» Kontron User's Guide «



Kontron microETXexpress®-OH



COMe-cOH2 / COMe-cOH6 Computer-on-Module (COM)

Version 0.96

Preliminary

Preliminary Draft

» Table of Contents «

1	User Information	1
1.1	About This Document	1
1.2	Copyright Notice	1
1.3	Trademarks	1
1.4	Standards	1
1.5	Warranty	2
1.6	Technical Support	2
2	Introduction	3
2.1	The COMe-cOH# COM	3
2.2	Naming Clarifications	4
2.3	Understanding the COM Functionality	4
2.4	COM Express® Documentation	5
2.5	COM Express® COM Benefits	5
3	Specifications	7
3.1	Functional Specification	7
3.2	Functional Block Diagrams	9
3.3	Mechanical Specifications	12
3.4	Electrical Specifications	13
3.4.1	Supply Voltage	13
3.4.2	Supply Current (Windows XP SP3)	13
3.5	Environmental Specifications	14
3.5.1	Temperature	14
3.6	MTBF	15
4	COM Connectors	16
4.1	Pin-Outs	17
4.1.1	Connectors X1A and X1B: microETXexpress® Interface (Type 6)	17
4.1.2	Connector J1 - Fan	37

4.1.3 Connector J2 - JTAG (AMD Embedded Probe)	38
4.1.4 Connectors J3 and J4 - SO-DIMM DDR3 Memory Sockets	38
4.1.5 Connector J5 -CPLD	39
4.1.6 PCI Express Interface	39
4.1.7 USB Interface	39
4.1.8 SATA Interface	41
4.1.9 Audio Interface	41
4.1.10 Serial IRQ	41
4.1.11 Graphics Interface	41
4.1.12 Ethernet Interface	42
4.1.13 SPI Bus Interface	42
4.1.14 LPC Bus Interface	43
4.1.15 Power Control Interface	44
4.1.16 Miscellaneous Circuits	45
5 Special Features	47
5.1 Watchdog Timer (WDT)	47
5.2 General Purpose Input and Output (GPIO)	47
5.3 ACPI Suspend Modes and Resume Events	47
6 Design Considerations	49
6.1 Thermal Management	49
6.2 Heat Spreader Dimensions	49
6.3 Onboard Fan Connector	49
6.3.1 Fan Connector Electrical Characteristics	51
7 System Resources	52
7.1 Interrupt Request (IRQ) Lines	52
7.2 Memory Area	52
7.3 I/O Address Map	52
7.4 Peripheral Component Interconnect (PCI) Devices	54
7.5 System Management Bus (SMBus)	54
7.6 K-Station Resources	55
8 BIOS Operation	56

8.1	Determining the BIOS Version.....	56
8.2	Setup Guide.....	56
8.2.1	Start AMIBIOS®8 Setup Utility	56
8.3	BIOS Setup.....	59
8.3.1	Main Menu	59
8.3.2	Advanced Menu	61
8.3.3	Chipset	106
8.3.4	South Bridge	124
8.3.5	Boot Configuration	144
8.3.6	Security	149
8.3.7	Save and Exit	152
9	Appendix B: Architecture Information	158
9.1	Buses.....	158
9.1.1	ISA, Standard PS/2 - Connectors	158
9.1.2	PCI/104	158
9.2	General PC Architecture.....	158
9.3	Ports.....	159
9.3.1	RS-232 Serial	159
9.3.2	Serial ATA	159
9.3.3	USB	159
9.4	Programming.....	159
10	Appendix C: Document Revision History	161

1 User Information

1.1 About This Document

This document provides information about products from Kontron and/or its subsidiaries. No warranty of suitability, purpose, or fitness is implied. While every attempt has been made to ensure that the information in this document is accurate, the information contained within is supplied "as-is" and is subject to change without notice.

For the circuits, descriptions and tables indicated, Kontron assumes no responsibility as far as patents or other rights of third parties are concerned.

1.2 Copyright Notice

Copyright © 2003-2011 Kontron

All rights reserved. No part of this document may be reproduced, transmitted, transcribed, stored in a retrieval system, or translated into any language or computer language, in any form or by any means (electronic, mechanical, photocopying, recording, or otherwise), without the express written permission of Kontron.

1.3 Trademarks

DIMM-PC®, PISA®, ETX®, ETXexpress®, microETXexpress®, X-board®, DIMM-IO® and DIMM-BUS® are trademarks or registered trademarks of Kontron. Kontron is a trademark or registered trademark of Kontron AG.

The following components used on this board are trademarked as follows:

- » IBM, XT, AT, PS/2 and Personal System/2 are trademarks of International Business Machines Corporation.
- » Microsoft is a registered trademark of Microsoft Corporation.
- » Intel is a registered trademark of Intel Corporation.
- » COM Express is a trademark of PICMG.
- » All other products and trademarks mentioned in this manual are trademarks of their respective owners and indicated with an "*".

1.4 Standards

Kontron is certified to ISO 9000 standards.

1.5 Warranty

This Kontron product is warranted against defects in material and workmanship for the warranty period from the date of shipment. During the warranty period, Kontron will at its discretion decide to repair or replace defective products.

Within the warranty period, the repair of products is free of charge as long as warranty conditions are observed.

The warranty does not apply to defects resulting from improper or inadequate maintenance or handling by the buyer, unauthorized modification or misuse, operation outside of the product's environmental specifications or improper installation or maintenance.

Kontron will not be responsible for any defects or damages to other products not supplied by Kontron that are caused by a faulty Kontron product.

1.6 Technical Support

Technicians and engineers from Kontron and/or its subsidiaries are available for technical support. We are committed to making our product easy to use and will help you use our products in your systems.

Please consult our website at <http://www.kontron.com/support> for the latest product documentation, utilities, drivers and support contacts. Consult our customer section for the latest BIOS downloads, Product Change Notifications and additional tools and software. You can also always contact your board supplier for technical support.

2 Introduction

2.1 The COMe-cOH# COM

The Kontron COMe-cOH# Computer-on-Module (COM) complies with the newly updated Rev. 2.0 COM Express® specification that provides for a compact form factor (95 x 95 mm) and new COM Express® Type 2 and Type 6 connector definitions. The COMe-cOH# COM design enables the development of graphics-intensive applications based on the Advanced Micro Devices (AMD) G-Series Advanced Processing Unit (APU) and the AMD Fusion Controller Hub (FCH) using the secure development path of an established, future-proof industry standard, the COM Express® compact form factor and pin-out Type 6.

The Kontron COMe-cOH# module processor has an integrated memory controller for up to 8Gbytes of single channel DDR3 memory. Support for the latest 3D graphics is provided by the integrated DirectX®11-capable graphics processing unit (GPU) within the FCH which also supports display interfaces with a maximum resolution of 2560 x 1600 VGA and 18-bit single-channel LVDS. With six PCI Express lanes for flexible configurations, the COMe-cOH# COM is ideal for multi-interface designs and brings the added benefit of low power consumption. These special features make this 95 x 95 mm Computer-on-Module a key solution for applications such as multimedia content delivery, outdoor digital signage, infotainment kiosks, POS/POI devices, panel PCs, and professional gaming systems that require high-level graphics performance and support for the latest APIs like DirectX 11, and where low thermal power design is also an advantage.

All modules in the Kontron microETXexpress® family are compliant with the COM Express® standard, compact form factor and follow either the Type 2 or Type 6 pin-out definition. These modules also take advantage of the new Kontron Embedded Application Programming Interface (Kontron EAPI), which is cross-platform middleware that is both form factor and operating system independent. This ensures easy interchangeability as well as design scalability and future migration paths.

The COMe-cOH# COM is a complete PC with standard interfaces such as USB, Gigabit Ethernet, SATA 2.0 as well as additional options like high-definition audio (HDA) and ACPI, I²C. The COMe-cOH# COM also supports the MARS and K-STATION Kontron tools.

2.2 Naming Clarifications

The COM Express® standard defines a Computer-On-Module, or COM, with all the components necessary for a bootable host computer, packaged as a super-component. The interfaces provide a smooth transition path from legacy parallel interfaces such as IDE or parallel ATA (PATA) to Low Voltage Differential Signaling (LVDS) interfaces including the PCI bus, PCI Express*, and Serial ATA (SATA).

- » ETXexpress® modules are Kontron COM Express® modules in the basic form factor (125mm x 95mm) that follow pin-out types 2 or 6.
- » microETXexpress® modules are Kontron COM Express® modules in the compact form factor (95mm x 95mm) that follow pin-out types 2 or 6.
- » nanoETXexpress® modules are Kontron COM Express® compatible modules in an ultra-small form factor that follow pin-out types 1 or 10 (55mm x 84mm)

NOTE: The Kontron COMe-cOH# module takes advantage of new features introduced in the PICMG COM COM.0 R2.0 COM Express® Specification.

2.3 Understanding the COM Functionality

All Kontron microETXexpress® and ETXexpress® modules contain two connectors (X1A and X1B), each with two rows. The primary connector rows are Row A and Row B (connector X1A). The secondary connector rows are Row C and Row D (connector X1B). The COMe-cOH# COM uses the PICMG COM Express® pin-out Type 6 definition, which is a new addition to the PICMG COM Express standard and documented in Revision 2.0 of the PICMG specification. The Type 6 pin-out is based on Type 2 and also supports new features on the secondary connector (rows C and D). The key changes are:

- » The PCI interface is no longer supported and the pins are used instead for digital display interfaces (DDI) and two additional PCI Express lanes
- » The IDE (PATA) parallel interface is no longer supported and the pins are used instead for additional transmit and receive pairs for four USB 3.0 ports.
- » Three dedicated DDI ports have been added. Ports 1, 2, and 3 can be configured individually for Display Port (DP), HDMI, or DVI and port 1 can also be used for SDVO.
- » SDVO is no longer supported.
- » Two optional two-wire RS232 serial ports have been added using pins formerly assigned to 12V signals.

The primary connector (Row A and Row B) on the COMe-cOH# COM features the following functionality:

- » Analog VGA graphics

- » LVDS 18-bit single channel
- » Gigabit Ethernet LAN
- » Serial ATA (SATA)
- » PCI Express*
- » SPI Bus
- » USB 2.0
- » LPC (Low Pin Count) bus
- » Watchdog timer (WDT)
- » GPIO
- » I²C
- » Intel® High Definition Audio (HDA)

The secondary connector (Row C and Row D) supports the following buses and I/O:

- » DP/DVI/HDMI
- » PCI Express

NOTE: For full descriptions of the COM Express Type 6 pin-outs, refer to the PICMG documentation that can be obtained from the PICMG website.

2.4 COM Express® Documentation

This product manual serves as one of three principal references for this COM Express® module design. It documents the specifications and features of the COMe-cOH# COM. The other two references, which are available from your Kontron support representative or from PICMG, include:

- » The PICMG COM Express® Specification, R2.0, which defines the COM Express® module form factors, pin-outs, and signals. This document can be obtained by filling out the order form on the PICMG website at <http://www.picmg.com>.
- » The PICMG COM Express® Design Guide, which serves as a general guide for baseboard design, with a focus on maximum flexibility to accommodate a wide range of COM Express® modules. This guide is on the PICMG website at <http://www.picmg.com>.

2.5 COM Express® COM Benefits

Compact form factor (95 x 95 mm) Computer-on-Module Express (COM Express) modules are very compact, highly integrated computers that use either the Type 2 or Type 6 COM Express® connector pin-outs. All microETXexpress®

modules feature a standardized form factor and a standardized connector layout for a specified set of signals, as defined in the PICMG COM Express® specification (PICMG COM.0.R2). This standardization lets designers create a single-system baseboard that can accept present and future microETXexpress modules.

Kontron microETXexpress® modules include common personal computer (PC) peripheral functions such as:

- » Graphics
- » USB ports
- » Ethernet
- » Audio
- » SATA hard disk drive format

Baseboard designers can optimize exactly how each of these functions is implemented physically for the intended application by placing connectors precisely where they are needed on a baseboard that is designed for an optimal fit in the system packaging.

A peripheral PCIe bus can be implemented directly on the application-specific baseboard rather than on mechanically unwieldy expansion cards. The ability to build a system on a single baseboard using the computer as one plug-in super-component simplifies packaging, eliminates cabling, and significantly reduces system-level total cost of ownership.

A single baseboard design can use a range of COM Express modules. This flexibility enables product differentiation at various price/performance points, and the design of future-proof systems with a built-in upgrade path. The modularity of a COM Express solution also ensures against obsolescence as computer technology evolves. A properly designed COM Express baseboard can work with several successive generations of COM Express modules.

A COM Express baseboard design has many of the advantages of a custom, computer-board design, but delivers better obsolescence protection, greatly reduced engineering effort, and faster time to market.

3 Specifications

3.1 Functional Specification

Processor: AMD G-Series Fusion Accelerated Processing Unit (APU)

- » CPU: AMD T40N with 2x 1.0 GHz single-core APU (9W)
AMD T52R with 1x 1.5 GHz single-core APU (18W)
AMD T44R with 1x 1.2 Ghz dual-core APU (9W)
AMD T56N with 2x 1.65 GHz dual-core APU (18W)
- » Cores: Up to 2 cores
- » Processor Speed: Up to 2x1.65 GHz
- » Memory Controller: Up to 8GB (2x4GB)single channel, two non-ECC DDR3 SODIMMs (1066 MHz or with the T56N CPU only, 1333 MHz)
- » Video Controller: DirectX®11-capable graphics and parallel processing engine
Unified Video Decoder (UVD) 3.0 (the dedicated high definition video acceleration block in the APU)
- » Graphics Processing: General purpose graphics processing unit (GPU)
AMD Radeon™ HD6310/HD6250 with support for DirectX® 11, OpenCL 1.1, and OpenGL 3.2 and 2.1 with resolution up to 2560x1600
- » I/O Controller PCI Express 2.0
- » Instruction Set: Kontron Embedded Application Programming Interface (Kontron EAPI)
- » Package: 19mm x 19mm
- » Thermal Spec: Operation: 0° to +60°C
Storage: -30° to +85°

Chipset: AMD Fusion Controller Hub (FCH)

- » USB: Up to 8xUSB 2.0 channels
2xUSB 3.0 channels as a build option
- » Audio: 3 channels High Definition Audio
- PCI Express: PCI Express 1.0 or 2.0
Six PCIe general purpose lanes
Up to four lanes (0 - 3) configured as x4, x2, or x1
Up to two lanes (4 -5) configured as x2 or x1
2xExpressCard
NOTE: The Fusion Controller Hub on the Type-2 module also has PCI support.
- » Suspend Modes Core Sleep States: S0, S3, S4, S5, S5eco

- » TDP: 2.3W
- » Package: 23mmx23mm

Display Interfaces

- » Features: 2 Digital Display Interfaces 0 and 1 (as defined by COM Express Rev. 2 Type 6)
Dual independent display pipes - two active display interfaces allowed
Display Port - resolution to 2560 x 1200 x 60 Hz
HDMI/DVI - resolution to 1920 x 1200 x 60 Hz
Single channel (18 bit) LVDS channel A (as defined by COM Express Rev. 2 Type 6)
Analog VGA, with max resolution up to 2560x1600 at 60 Hz (on COM Express A-B connector)

Storage

- » SATA: 4xSATA 2.0 supporting up to 6.0 Gbps transfer rate

Onboard Devices:

- » Ethernet: Intel® 82574L GbE Controller 10/100/1000 Mbit
- » Ethernet Features: S0 or S5 power, under BIOS control, supporting WakeOnLAN
- » USB 3.0 Host Controller Renesas uPD720200A(Type-6 only)
- » DP Analogix ANX3110 DP 24-bit 2-channel LVDS Converter (Type-2 only)
- » Security: N/A
- » Watchdog Timer: SIO implementation
BIOS enables and configures watchdog in the CPLD
Watchdog has the option to generate NMI after the delay has expired
- » Power Management: BIOS-enabled ACPI 3.0 power managementfor supported OS

Additional Interfaces:

- » LPC bus: Yes, to COM Express A-B connector
- » SMBus: Yes, to COM Express A-B connector
- » I²C: Yes, the I²C bus can be implemented using an FCH SMBus port. (COM Express Rev 2.0 specifies that the I²C bus shall be active in S5)
- » GPIO: Yes, 8xGPIO, 4 GPI and 4 GPO (inputs are interrupt-capable)

- » SPI Yes, to COM Express A-B connector, SPI bus includes carrier board SPI device support
- » K-Station: Yes
- » Bootlogo: TBD
- » MARS: N/A
- » HWM: Temperature Monitoring for CPU and Board Temperature (Nuvoton NCT5577D SIO hardware monitor)
- » Passive Cooling: Passive and Critical Trip Point
- » ACPI: ACPI 3.0
- » Suspend Modes: S0, S3, S4, S5/WOL enabled, S5/WOL disabled, S5eco
- » Input Voltage: Single supply support with wide range power supply input, 4.75V - 18V
5.0V supply is the optional standby power rail.

3.2 Functional Block Diagrams

Figure 1 is the COMe-cOH# COM Express™ Type 6 module block diagram.

Figure 1: COMe-cOH# COM (Type 6) Block Diagram

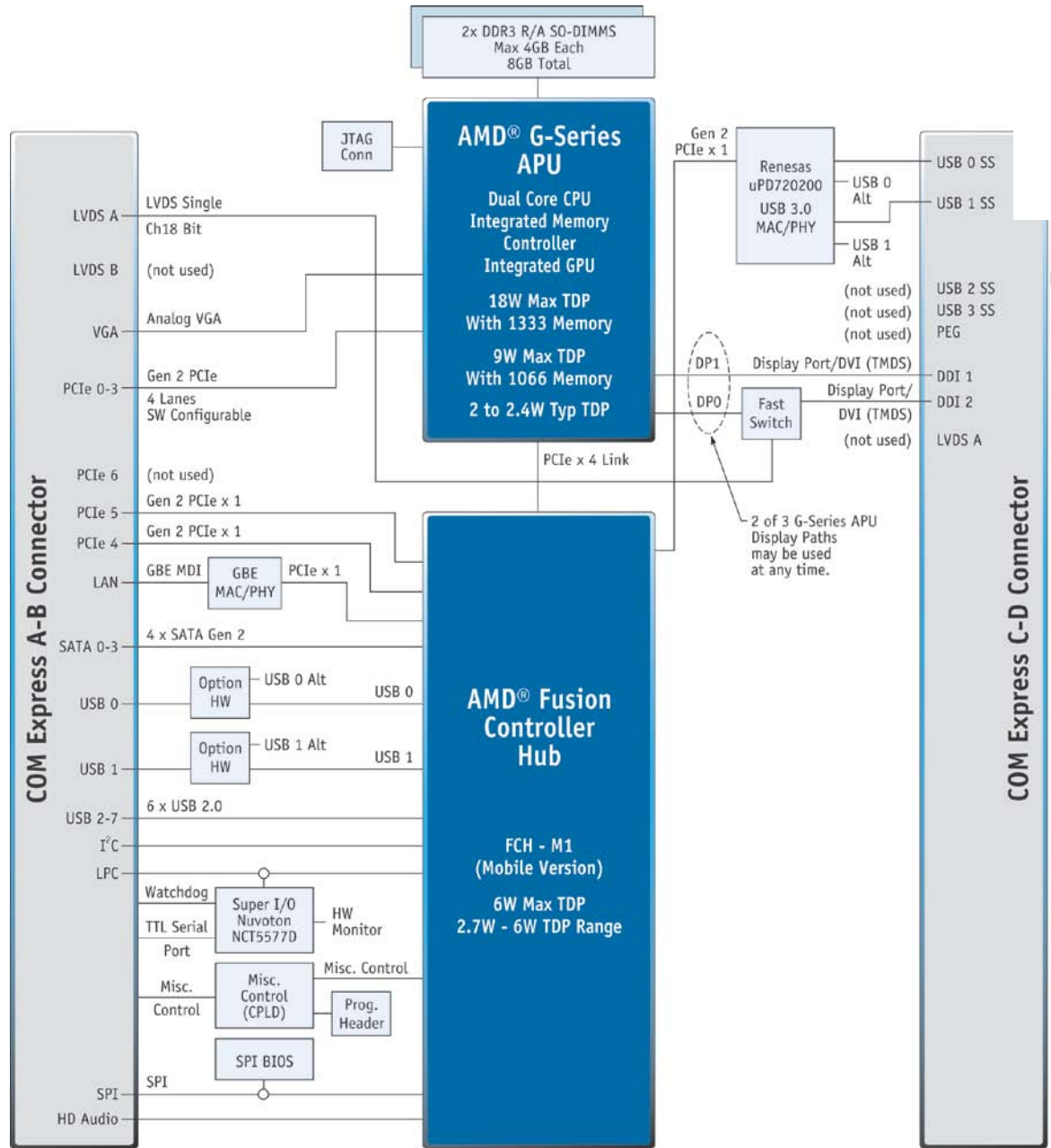

0H0018

Figure 2 is the COMe-cOH# COM Express™ Type 2 module block diagram.

Figure 2: COMe-cOH# COM (Type 2) Block Diagram

Preliminary Draft

NOTE: The Type 2 block diagram is for reference only. Complete Type 2 module information will be provided in a future version of this manual.

3.3 Mechanical Specifications

Module Dimensions

» 95 mm x 95 mm ± 0.2 mm (3.47 in. x 3.47 in)

Height on Top

- » Approximately 8.0 mm maximum (without the PCB)
- » Height varies depending on whether an optional cooling solution (either a passive heat sink or a heat spreader plate) is installed

Height on Bottom

» Approximately 4.06 mm maximum (without the PCB)

Figure 3 is the COMe-cOH# COM mechanical drawing.

Figure 3: COMe-cOH# COM Mechanical Drawing

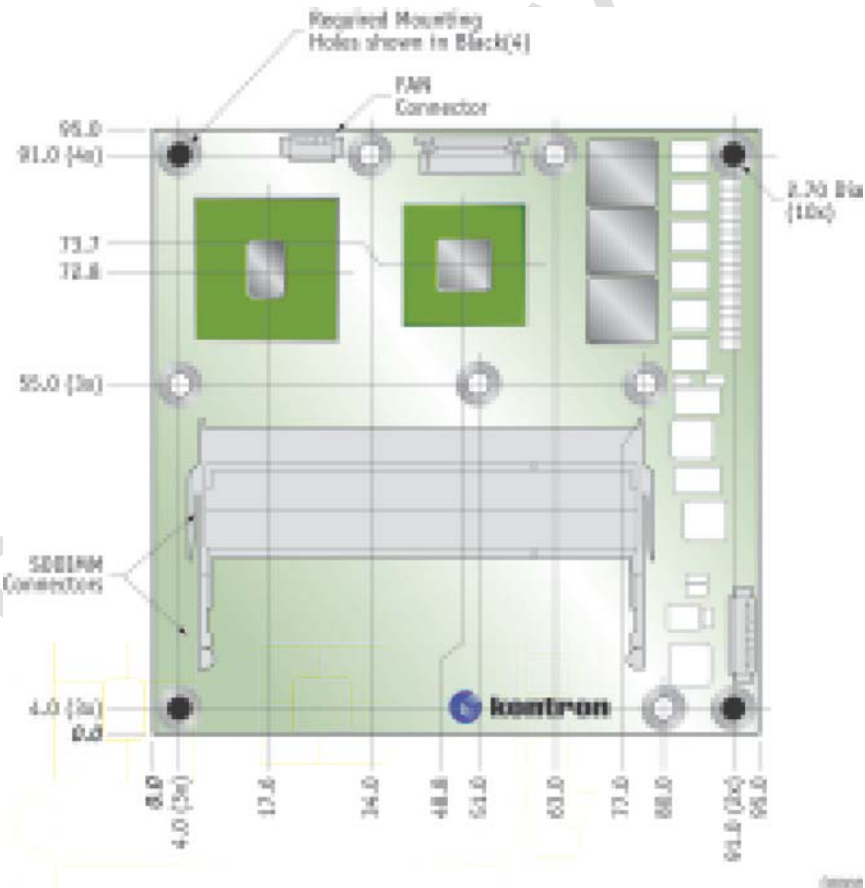

All dimensions are shown in millimeters. The COM Express® specification says that these holes should be $\pm 0.25\text{mm}$ [± 0.010 "], unless otherwise noted. The tolerances for placement of the COM Express connector with respect to the peg holes (dimensions [16.50, 6.00]) should be $\pm 0.10\text{mm}$ [± 0.004 "]. The mounting holes shown in the drawing use 6mm diameter pads and 2.7mm plated holes for use with 2.5mm hardware. The pads are tied to the PCB ground plane. Black circles represent the mounting holes required by the PICMG COM Express® standard.

3.4 Electrical Specifications

3.4.1 Supply Voltage

ATC Power

- » 4.75V to +18V main power is on the COM Express VCC_12V pins and 4.75V to 5.25V standby power is on the VCC_5V_SBY. RTC power is provided on the VCC_RTC pins. VCC_12V may or may not collapse in suspend states S3, S4, and S5.

Single Power Supply

- » 4.75V to +18V main power is on the COM Express VCC_12V pins and standby power if needed is also provided on the VCC-12V pins. The VCC_5V_SBY pins may be floating or may be tied to a 5V source on the carrier board. RTC power is provided on the VCC_RTC pins.

Power Supply Risetime

To be supplied in a future release of this manual.

3.4.2 Supply Current (Windows XP SP3)

The testing performed to capture the supply current data used tested modules mounted on a Kontron evaluation board with a mouse and keyboard connected. The power consumption tests were executed in Windows XP (with SP3) using a tool to stress the CPU at 100 % load. The power measurement values were captured after 15 minutes of full load or a stable CPU core temperature of 90°C. To ensure a stable die temperature, a corresponding heat sink was used to hold the temperature under the critical trip point. The modules were tested using the maximum CPU frequency. For more detailed information, refer to the "Power Consumption" diagrams on the EMD Customer section of the Kontron website.

Table 1: AMD G-Series APU

	Power Consumption in [W]
Windows Desktop (idle)	TBD
TAT at maximum power configuration	TBD
S3 with Wake-on-LAN disabled	TBD
S5 with Wake-on-LAN disabled	TBD

NOTE: It is difficult to test for all possible applications on the market. There may be an application that draws more power from the CPU than the values measured in the table above. Take this into consideration if you are at the limit of the thermal specification, in which case you should consider improving your thermal solution.

3.5 Environmental Specifications

3.5.1 Temperature

Operating: (with Kontron heat spreader plate assembly):

- » Ambient temperature: 0 to 70°C
- » Maximum heat sink temperature: 0 to 70°C* (without a fan on the 9W APU SKUs)
- » Non-operating: -30 to +85°C

NOTES: *1) The maximum operating temperature with the heat spreader plate installed is the maximum measurable temperature on any spot on the heat spreader surface. You must maintain the temperature according to the specification above.

Operating (without Kontron heat spreader plate assembly):

- » Maximum operating temperature: 0-60°C
- » Non operating: -30°C to +85°C

NOTE: **The maximum operating temperature is the maximum measurable temperature on any spot on the module surface. You must maintain the temperature according to the specification above.

Humidity

- » Operating: TBD
- » Non operating: TBD

3.6 MTBF

System MTBF = 345,887 hours at 40°C

Preliminary Draft

4 COM Connectors

The pin-outs for microETXexpress® interface connectors X1A (primary connector, rows A and B) and X1B (secondary connector, rows C and D) are documented for convenient reference. See the PICMG COM Express® Specification on the PICMG website and COM Express® Design Guide on the Kontron website for detailed, design-level information.

Figure 4: COM Interface Connector Locations

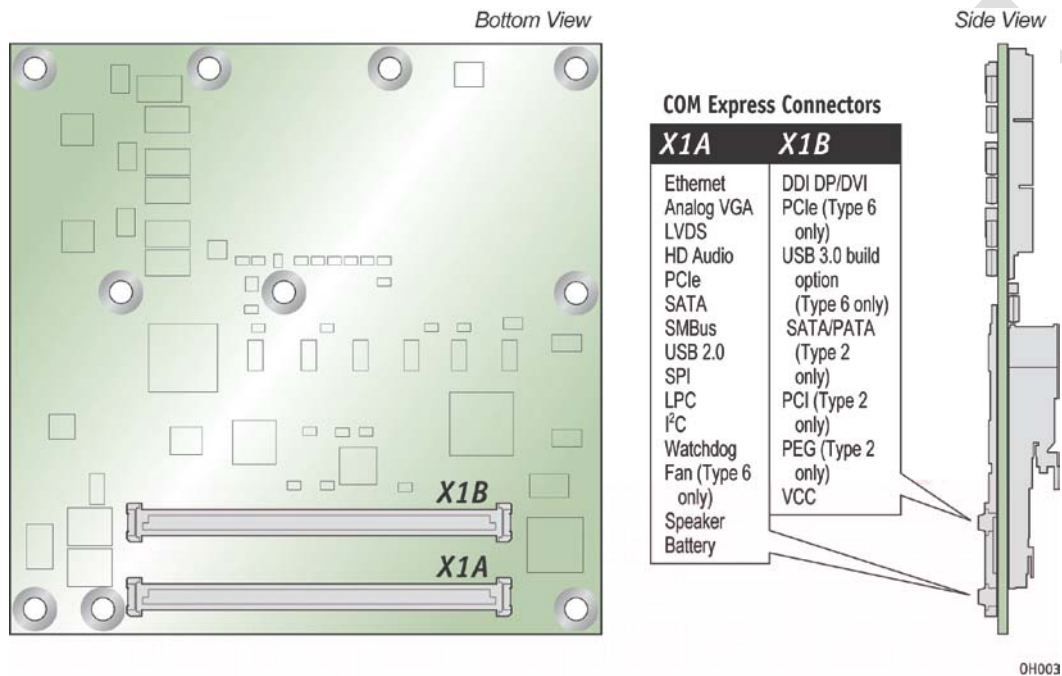

Table 2: General Signal Description Key

Type	Description
I/O-3.3	Bi-directional 3.3 V IO-Signal
I/O-5T	Bi-dir. 3.3V I/O (5V Tolerance)
I/O-5	Bi-directional 5V I/O-Signal
I-3,3	3.3V Input
I/OD	Bi-directional Input/Output Open Drain
I-5T	3.3V Input (5V Tolerance)
OA	Output Analog
OD	Output Open Drain
O-1,8	1.8V Output
O-3,3	3.3V Output
O-5	5V Output
DP-I/O	Differential Pair Input/Output
DP-I	Differential Pair Input
DP-O	Differential Pair Output

Type	Description
PU	Pull-Up Resistor
PD	Pull-Down Resistor
PWR	Power Connection
nc	Not connected, Signal not available

NOTE: To protect external power lines of peripheral devices, make sure that the wires have the right diameter to withstand the maximum available current and the enclosure of the peripheral device fulfills the fire-protection requirements in IEC/EN60950

4.1 Pin-Outs

4.1.1 Connectors X1A and X1B: microETXexpress® Interface (Type 6)

NOTE: The Type 2 connector pin-outs will be provided in a future version of this manual.

Table 3: Connector X1A - Row A

Pin	Signal	Description	Type	Termination	Comment
A1	GND (Fixed)	Power Ground	PWR	-	-
A2	GBE0_MDI3-	Ethernet Receive Data-	DP-I	Intel® 82574L	-
A3	GBE0_MDI3+	Ethernet Receive Data+	DP-I	Intel® 82574L	-
A4	GBE0_LINK100#	Ethernet Speed LED 100Mbps	OD mb	FET PD mb	-
A5	GBE0_LINK1000#	Ethernet Speed LED 1000Mbps	OD mb	FET PD mb	-
A6	GBE0_MDI2-	Ethernet Receive Data-	DP-I	Intel® 82574L	-
A7	GBE0_MDI2+	Ethernet Receive Data+	DP-I	Intel® 82574L	-
A8	GBE0_LINK#	LAN Link LED	OD	FET PD mb	-
A9	GBE0_MDI1-	Ethernet Receive Data-	DP-I	Intel® 82574L	-
A10	GBE0_MDI1+	Ethernet Receive Data+	DP-I	Intel® 82574L	-
A11	GND (Fixed)	Power Ground	PWR	-	-
A12	GBE0_MDI0-	Ethernet Transmit Data-	DP-O	Intel® 82574L	-
A13	GBE0_MDI0+	Ethernet Transmit Data+	DP-O	Intel® 82574L	-
A14	GBE0_CTREF	LAN Reference Voltage	O-3.3		-

Pin	Signal	Description	Type	Termination	Comment
A15	SUS_S3#	Indicates Suspend to RAM state	O-3.3	CPLD I/O	CPLD I/O
A16	SATA0_TX+	SATA 0 Transmit Data+	DP-0		-
A17	SATA0_TX-	SATA 0 Transmit Data-	DP-0		-
A18	SUS_S4#	Indicates Suspend to Disk state	O-3.3	CPLD I/O	CPLD I/O
A19	SATA0_RX+	SATA 0 Receive Data+	DP-I		
A20	SATA0_RX-	SATA 0 Receive Data-	DP-I		-
A21	GND (Fixed)	Power Ground	PWR		-
A22	SATA2_TX+	SATA 2 Transmit Data-	DP-0		
A23	SATA2_TX-	SATA 2 Transmit Data+	DP-0		
A24	SUS_S5#	Indicates Soft Off state	O-3.3	CPLD I/O	CPLD I/O
A25	SATA2_RX+	SATA 2 Receive Data+	Not connected	nc	nc
A26	SATA2_RX-	SATA 2 Receive Data-	Not connected	nc	nc
A27	BATLOW#	Indicates low external battery	I-3.3		CPLD I/O
A28	(S)ATA_ACT#	SATA, IDE, SD Activity Indicator	O-3.3	Buffered output	
A29	AC/HDA_SYNC	HD Audio Sync	O-3.3		
A30	AC/HDA_RST#	HD Audio Reset	O-3.3		
A31	GND Fixed)	Power Ground	PWR	-	-
A32	AC/HDA_BITCLK	HD Audio Clock	O-3.3		
A33	AC/HDA_SDOUT	HD Audio Data	O-3.3		
A34	BIOS_DIS0#	Disable Module BIOS Enables boot from a BIOS on Baseboard	I-3.3		
A35	THRMTRIP#	CPU thermal shutdown indicator	O-3.3		
A36	USB6-	USB Data- Port #6	DP-I/O		-
A37	USB6+	USB Data+ Port #6	DP-I/O		-
A38	USB_6_7_OC#	USB Overcurrent Pair 6/7	I-3.3		
A39	USB4-	USB Data- Port #4	DP-I/O		
A40	USB4+	USB Data+ Port #4	DP-I/O		-

Pin	Signal	Description	Type	Termination	Comment
A41	GND (Fixed)	Power Ground	PWR	-	-
A42	USB2-	USB Data- Port #2			
A43	USB2+	USB Data+ Port #2	DP-I/O		
A44	USB_2_3_OC#	USB Overcurrent Pair 2/3	I-3.3		
A45	USB0-	USB Data- Port #0	DP-I/O		
A46	USB0+	USB Data+ Port #0	DP-I/O		
A47	VCC_RTC	RTC Power Supply +3V	PWR	-	-
A48	EXCD0_PERST #	PCIe Express Card 0 Reset	O-3.3		
A49	EXCD0_CPPE#	PCIe Express Card 0 Request	I-3.3		
A50	LPC_SERIRQ	LPC Serial Interrupt Request	IO-3.3		
A51	GND (Fixed)	Power Ground	PWR	-	-
A52	PCIE_TX5+	PCIe 5 Transmit Data+	DP-O		
A53	PCIE_TX5-	PCIe 5 Transmit Data-	DP-O		
A54	GPI0	General Purpose Input 0	I-3.3		
A55	PCIE_TX4+	PCIe 4 Transmit Data+	DP-O		
A56	PCIE_TX4-	PCIe 4 Transmit Data-	DP-O		
A57	GND (Fixed)	Power Ground	PWR	-	-
A58	PCIE_TX3+	PCIe 3 Transmit Data+	DP-O		
A59	PCIE_TX3-	PCIe 3 Transmit Data-	DP-O		
A60	GND (Fixed)	Power Ground	PWR	-	-
A61	PCIE_TX2+	PCIe 2 Transmit Data+	DP-O		
A62	PCIE_TX2-	PCIe 2 Transmit Data-	DP-O		
A63	GPI1	General Purpose Input 1	I-3.3		
A64	PCIE_TX1+	PCIe 1 Transmit Data+	DP-O		
A65	PCIE_TX1-	PCIe 1 Transmit Data-	DP-O		
A66	GND (Fixed)	Power Ground	PWR	-	-
A67	GPI2	General Purpose Input 2	I-3.3		
A68	PCIE_TX0+	PCIe lane #0 Transmit+	DP-O		
A69	PCIE_TX0-	PCIe lane #0 Transmit-	DP-O		

Pin	Signal	Description	Type	Termination	Comment
A70	GND (Fixed)	Power Ground	PWR	-	-
A71	LVDS_A0+	LVDS Channel A (positive)	DP-0		
A72	LVDS_A0-	LVDS Channel A (negative)	DP-0		-
A73	LVDS_A1+	LVDS Channel A (positive)	DP-0		-
A74	LVDS_A1-	LVDS Channel A (negative)	DP-0		
A75	LVDS_A2+	LVDS Channel A (positive)	DP-0		
A76	LVDS_A2-	LVDS Channel A (negative)	DP-0		
A77	LVDS_VDD_EN	LVDS Panel Power Controller	O-3.3		
A78	LVDS_A3+	LVDS Channel A (positive)	DP-0		
A79	LVDS_A3-	LVDS Channel A (negative)	DP-0		
A80	GND (Fixed)	Power Ground	PWR	-	-
A81	LVDS_A_CK+	LVDS Channel A Clock+	DP-0		
A82	LVDS_A_CK-	LVDS Channel A Clock-	DP-0		
A83	LVDS_I2C_CK	LVDS I2C Clock	IO-3.3		
A84	LVDS_I2C_DATA	LVDS I2C Data	IO-3.3		
A85	GPI3	General Purpose Input 3	I-3.3		
A86	RSVD	Reserved	Not connected	nc	nc
A87	RSVD	Reserved	Not connected	Nc	nc
A88	PCIE0_CK_RE F+	PCIe Clock (positive)	DP-0		
A89	PCIE0_CK_RE F-	PCIe Clock (negative)	DP-0		
A90	GND (Fixed)	Power Ground	PWR	-	-
A91	SPI_Power	Power for off-board SPI flash	O-3.3		
A92	SPI_MISO	SPI Master In Slave Out data line	I-3.3		
A93	GPO0	General Purpose Output 0	O-3.3		
A94	SPI_CLK	SPI clock line for off-board SPI	O-3.3		
A95	SPI_MOSI	SPI Master Out Slave In data line	O-3.3		-

Pin	Signal	Description	Type	Termination	Comment
A96	TPM_PP	Trusted Platform Module Physical Presence pin	I-3.3		
A97	TYPE10#	Not connected for Type 6 module	Not connected	nc	nc
A98	SER0_TX	Gen. Purpose Serial Port 0 Transmit	Not connected	nc	nc
A99	SER0_RX	Gen. Purpose Serial Port 0 Receive	Not connected	nc	nc
A100	GND (Fixed)	Power Ground	PWR	-	-
A101	SER1_TX	General Purpose Serial Port 1 Transmit	Not connected	nc	nc
A102	SER1_RX	General Purpose Serial Port 1 Receive	Not connected	nc	nc
A103	LID#	LID Button	I/OP-3.3		
A104	VCC_12V	12V VCC	PWR	-	-
A105	VCC_12V	12V VCC	PWR	-	-
A106	VCC_12V	12V VCC	PWR	-	-
A107	VCC_12V	12V VCC	PWR	-	-
A108	VCC_12V	12V VCC	PWR	-	-
A109	VCC_12V	12V VCC	PWR	-	-
A110	GND	Power Ground	PWR	-	-

Table 4: Connector X1A - Row B

Pin	Signal	Description	Type	Termination	Comment
B1	GND (Fixed)	Power Ground	PWR	-	-
B2	GBE0_ACT#	Ethernet Activity LED	OD	FET PD	nc
B3	LPC_FRAME#	LPC Frame Indicator	O-3.3		
B4	LPC_AD0	LPC Address/Data Bus	IO-3.3		
B5	LPC_AD1	LPC Address/Data Bus	IO-3.3		
B6	LPC_AD2	LPC Address/Data Bus	IO-3.3		
B7	LPC_AD3	LPC Address/Data Bus	IO-3.3		
B8	LPC_DRQ0#	LPC Serial DMA Request	I-3.3		
B9	LPC_DRQ1#	LPC Serial DMA Request	I-3.3		
B10	LPC_CLK	LPC Clock	O-3.3		

Pin	Signal	Description	Type	Termination	Comment
B11	GND (Fixed)	Power Ground	PWR	-	-
B12	PWRBTN#	Power Button Input	I-3.3		
B13	SMB_CLK	SMBus Clock	O-3.3		
B14	SMB_DAT	SMBus Data	IO-3.3		
B15	SMB_ALERT#	SMBus Interrupt	IO-3.3		
B16	SATA1_TX+	SATA 1 Transmit Data+	DP-0		
B17	SATA1_TX-	SATA 1 Transmit Data-	DP-0		
B18	SUS_STAT#	Imminent suspend operation; used to notify LPC devices.	O-3.3		
B19	SATA1_RX+	SATA 1 Receive Data+	DP-I		
B20	SATA1_RX-	SATA 1 Receive Data-	DP-I		
B21	GND (Fixed)	Power Ground	PWR	-	-
B22	SATA3_TX+	SATA 3 Transmit Data+	DP-0		
B23	SATA3_TX-	SATA 3 Transmit Data-	DP-0		
B24	PWR_OK	Power OK from power supply	I-3.3		
B25	SATA3_RX+	SATA 3 Receive Data+	DP-I		
B26	SATA3_RX-	SATA 3 Receive Data-	DP-I		
B27	WDT	Watchdog Timeout	O-3.3		
B28	AC/HDA_SDIN 2	Audio CODEC Serial Data In 2	I-3.3		
B29	AC/HDA_SDIN 1	Audio CODEC Serial Data In 1	I-3.3		
B30	AC/HDA_SDIN 0	Audio CODEC Serial Data In 0	I-3.3		
B31	GND (Fixed)	Power Ground	PWR	-	-
B32	SPKR	Speaker Interface	O-3.3		
B33	I2C_CLK	I ² C Clock	IO-3.3		
B34	I2C_DAT	I ² C Data	IO-3.3		
B35	THRM#	Over Temperature Indicator	I-3.3		
B36	USB7-	USB Data- Port #7	DP-I/O		
B37	USB7+	USB Data+ Port #7	DP-I/O		
B38	USB_4_5_OC#	USB Overcurrent Pair 4/5	I-3.3		
B39	USB5-	USB Data- Port #5	DP-I/O		

Pin	Signal	Description	Type	Termination	Comment
B40	USB5+	USB Data+ Port #5	DP-I/O		
B41	GND (Fixed)	Power Ground	PWR	-	-
B42	USB3-	USB Data- Port #3	DP-I/O		
B43	USB3+	USB Data+ Port #3	DP-I/O		
B44	USB_0_1_OC#	USB Overcurrent Pair 0/1	I-3.3		
B45	USB1-	USB Data- Port #1	DP-I/O		
B46	USB1+	USB Data+ Port #1	DP-I/O		
B47	EXCD1_PERST#	PCIe Express Card 1 Reset	O-3.3		
B48	EXCD1_CPPE#	PCIe Express Card 1 Request	I-3.3		
B49	SYS_RESET#	Reset button input	I-3.3		
B50	CB_RESET#	Carrier Board Reset	O-3.3		
B51	GND (Fixed)	Power Ground	PWR	-	-
B52	PCIE_RX5+	PCIe 5 Receive Data+	DP-I		
B53	PCIE_RX5-	PCIe 5 Receive Data-	DP-I		
B54	GPO1	General Purpose Output 1	O-3.3		
B55	PCIE_RX4+	PCIe 4 Receive Data+	DP-I		
B56	PCIE_RX4-	PCIe 4 Receive Data-	DP-I		
B57	GPO2	General Purpose Output 2	O-3.3		
B58	PCIE_RX3+	PCIe 3 Receive Data+	DP-I		
B59	PCIE_RX3-	PCIe 5 Receive Data-	DP-I		
B60	GND (Fixed)	Power Ground	PWR	-	-
B61	PCIE_RX2+	PCIe 2 Receive Data+	DP-I		
B62	PCIE_RX2-	PCIe 2 Receive Data-	DP-I		
B63	GPO3	General Purpose Output 3	O-3.3		
B64	PCIE_RX1+	PCIe 1 Receive Data+	DP-I		
B65	PCIE_RX1-	PCIe 1 Receive Data-	DP-I		
B66	WAKE0#	PCI Express Wake Event	I-3.3		
B67	WAKE1#	General Purpose Wake Event	I-3.3		
B68	PCIE_RX0+	PCIe lane #0	DP-I		

Pin	Signal	Description	Type	Termination	Comment
		Receive+			
B69	PCIE_RX0-	PCIe lane #0 Receive-	DP-I		
B70	GND (Fixed)	Power Ground	PWR	-	-
B71	LVDS_B0+	LVDS Channel B0 (Positive)	DP-O		
B72	LVDS_B0-	LVDS Channel B0 (Negative)	DP-O		
B73	LVDS_B1+	LVDS Channel B1 (Positive)	DP-O		
B74	LVDS_B1-	LVDS Channel B1 (Negative)	DP-O		
B75	LVDS_B2+	LVDS Channel B2 (Positive)	DP-O		
B76	LVDS_B2-	LVDS Channel B2 (Negative)	DP-O		
B77	LVDS_B3+	LVDS Channel B3 (Positive)	DP-O		
B78	LVDS_B3-	LVDS Channel B3 (Negative)	DP-O		
B79	LVDS_BKLT_EN	Backlight Enable	O-3.3		
B80	GND (Fixed)	Power Ground	PWR	-	-
B81	LVDS_B_CK+	LVDS Channel B Clock+	DP-O		
B82	LVDS_B_CK-	LVDS Channel B Clock-	DP-O		
B83	LVDS_BKLT_CTRL	Backlight Brightness Control	O-3.3		
B84	VCC_5V_SBY	+5V Standby	PWR	-	-
B85	VCC_5V_SBY	+5V Standby	PWR	-	-
B86	VCC_5V_SBY	+5V Standby	PWR	-	-
B87	VCC_5V_SBY	+5V Standby	PWR	-	-
B88	BIOS_DIS1#	BIOS Disable 1 (offboard SPI select)	I-3.3		
B89	VGA_RED	Analog Video Red	O		
B90	GND (Fixed)	Power Ground	PWR	-	-
B91	VGA_GRN	Analog Video Green	O		
B92	VGA_BLU	Analog Video Blue	O		
B93	VGA_HSYNC	Analog Video Horizontal Sync	O-3.3		
B94	VGA_VSYNC	Analog Video Vertical Sync	O-3.3		
B95	VGA_I2C_CK	Analog Video I2C Clock	IO/OD-3.3		
B96	VGA_I2C_DAT	Analog Video I2C Data	IO/OD-3.3		

Pin	Signal	Description	Type	Termination	Comment
B97	SPI_CS#	SPI Chip Select	O-3.3		
B98	RSVD	Reserved	Not connected	nc	nc
B99	RSVD	Reserved	Not connected	nc	nc
B100	GND (Fixed)	Power Ground	PWR	-	-
B101	FAN_PWMOUT	Fan Speed Control	O/OP-3.3		
B102	FAN_TACHIN	Fan Tachometer Input	I/OP-3.3		
B103	SLEEP#	Sleep Button	I/OP-3.3		
B104	VCC_12V_16	12V VCC	PWR	-	-
B105	VCC_12V_17	12V VCC	PWR	-	-
B106	VCC_12V_18	12V VCC	PWR	-	-
B107	VCC_12V_19	12V VCC	PWR	-	-
B108	VCC_12V_20	12V VCC	PWR	-	-
B109	VCC_12V_21	12V VCC	PWR	-	-
B110	GND (Fixed)	Power Ground	PWR		

NOTE: The termination resistors in this table are already mounted on the microETXexpress® board. Refer to the PICMG COM Express® Design Guide for information about additional termination resistors.

Table 5: Connector X1B - Row C

Pin	Signal	Description	Type	Termination	Comment
C1	GND (Fixed)	Power Ground	PWR	-	-
C2	GND	Power Ground	PWR	-	-
C3	USB_SSRX0-	SuperSpeed USB Data Receive Path 0-	Not connected	nc	nc
C4	USB_SSRX0+	SuperSpeed USB Data Receive Path 0+	Not connected	nc	nc
C5	GND	Power Ground	PWR	-	-
C6	USB_SSRX1-	SuperSpeed USB Data Receive Path 1-	Not connected	nc	nc
C7	USB_SSRX1+	SuperSpeed USB Data Receive Path 1+	Not connected	nc	nc
C8	GND	Power Ground	PWR	-	-
C9	USB_SSRX2-	SuperSpeed USB Data Receive Path 2-	Not connected	nc	nc
C10	SUB_SSRX2+	SuperSpeed USB Data Receive Path 2+	Not connected	nc	nc
C11	GND (Fixed)	Power Ground	PWR		

Pin	Signal	Description	Type	Termination	Comment
C12	USB_SSRX3-	SuperSpeed USB Data Receive Path 3-	Not connected	nc	nc
C13	USB_SSRX3+	SuperSpeed USB Data Receive Path 3+	Not connected	nc	nc
C14	GND	Power Ground	PWR	-	-
C15	DDI1_PAIR6+	Digital Display Interface	Not connected	nc	nc
C16	DDI1_PAIR6-	Digital Display Interface	Not connected	nc	nc
C17	RSVD	Reserved	Not connected	nc	nc
C18	RSVD	Reserved	Not connected	nc	nc
C19	PCIE_RX6+	PCI Express Differential Receive Pair 6+	DP-I		
C20	PCIE_RX6-	PCI Express Differential Receive Pair 6-	DP-I		
C21	GND (Fixed)	Power Ground	PWR		
C22	PCIE_RX7+	PCI Express Differential Receive Pair 7+	Not connected	nc	nc
C23	PCIE_RX7-	PCI Express Differential Receive Pair 7-	Not connected	nc	nc
C24	DDI1_HPD	Digital Display Interface Hot-plug detect	I-3.3		
C25	DDI1_PAIR4+	Digital Display Interface	Not connected	nc	nc
C26	DDI1_PAIR4-	Digital Display Interface	Not connected	nc	nc
C27	RSVD	Reserved	Not connected	nc	nc
C28	RSVD	Reserved	Not connected	nc	nc
C29	DDI1_PAIR5+	Digital Display Interface	Not connected	nc	nc
C30	DDI1_PAIR5-	Digital	Not connected	nc	nc

Pin	Signal	Description	Type	Termination	Comment
		Display Interface			
C31	GND (Fixed)	Power Ground	PWR	-	-
C32	DDI2_CRTLCLK_AUX+	HDMI/DVI I ² C CTRLCLK	I/O-3.3		
C33	DDI2_CRTLDATA_AUX-	HDMI/DVI I ² C CRTLDATA	I/O-3.3		
C34	DDI2_DDC_AUX_SELECT	Selects function of DDI CTRL & DATA Aux	I-3.3		
C35	RSVD	Reserved	Not connected	nc	nc
C36	DDI3_CRTLCLK_AUX+	HDMI/DVI I ² C CTRLCLK	I/O-3.3		
C37	DDI3_CRTLDATA_AUX-	HDMI/DVI I ² C CRTLDATA	I/O-3.3		
C38	DDI3_DDC_AUX_SELECT	Selects function of DDI CTRL & DATA Aux	I-3.3		
C39	DDI3_PAIR0+	Digital Display Interface	DP-0		
C40	DDI3_PAIR0-	Digital Display Interface	DP-0		
C41	GND (Fixed)	Power Ground	PWR	-	-
C42	DDI3_PAIR1+	Digital Display Interface	DP-0		
C43	DDI3_PAIR1-	Digital Display Interface	DP-0		
C44	DDI3_HPD	Digital Display Interface Hot-plug detect	I-3.3		
C45	RSVD	Reserved	Not connected	nc	nc
C46	DDI3_PAIR2+	Digital Display Interface	DP-0		
C47	DDI3_PAIR2-	Digital Display Interface	DP-0		
C48	RSVD	Reserved	Not connected	nc	nc
C49	DDI3_PAIR3+	Digital Display Interface	DP-0		

Pin	Signal	Description	Type	Termination	Comment
C50	DDI3_PAIR3-	Digital Display Interface	DP-O		
C51	GND (Fixed)	Power Ground	PWR	-	-
C52	PEG_RX0+	PCI Express Graphics Receive Lane 0 Positive	DP-I		
C53	PEG_RX0-	PCI Express Graphics Receive Lane 0 Negative	DP-I		
C54	TYPE0#	Not connected for Type 6 module	Not connected	nc	nc
C55	PEG_RX1+	PCI Express Graphics Receive Lane 1 Positive	DP-I		
C56	PEG_RX1-	PCI Express Graphics Receive Lane 1 Negative	DP-I		
C57	TYPE1#	Not connected for Type 6 module	Not connected	nc	nc
C58	PEG_RX2+	PCI Express Graphics Receive Lane 2 Positive	DP-I		
C59	PEG_RX2-	PCI Express Graphics Receive Lane 2 Negative	DP-I		
C60	GND (Fixed)	Power Ground	PWR	-	-
C61	PEG_RX3+	PCI Express Graphics Receive Lane 3 Positive	DP-I		
C62	PEG_RX3-	PCI Express Graphics Receive Lane 3 Negative	DP-I		
C63	RSVD	Reserved	Not connected	nc	nc
C64	RSVD	Reserved	Not connected	nc	nc-
C65	PEG_RX4+	PCI Express Graphics Receive Lane 4 Positive	DP-I		
C66	PEG_RX4-	PCI Express Graphics	DP-I		

Pin	Signal	Description	Type	Termination	Comment
		Receive Lane 4 Negative			
C67	RSVD	Reserved	Not connected	nc	nc
C68	PEG_RX5+	PCI Express Graphics Receive Lane 5 Positive	DP-I		
C69	PEG_RX5-	PCI Express Graphics Receive Lane 5 Negative	DP-I		
C70	GND (Fixed)	Power Ground	PWR	-	-
C71	PEG_RX6+	PCI Express Graphics Receive Lane 6 Positive	DP-I		
C72	PEG_RX6-	PCI Express Graphics Receive Lane 6 Negative	DP-I		
C73	GND	Power Ground	PWR	-	-
C74	PEG_RX7+	PCI Express Graphics Receive Lane 7 Positive	DP-I		
C75	PEG_RX7-	PCI Express Graphics Receive Lane 7 Negative	DP-I		
C76	GND (Fixed)	Power Ground	PWR	-	-
C77	RSVD	Reserved	Not connected	nc	nc
C78	PEG_RX8+	PCI Express Graphics Receive Lane 8 Positive	DP-I		
C79	PEG_RX8-	PCI Express Graphics Receive Lane 8 Negative	DP-I		
C80	GND (Fixed)	Power Ground	PWR	-	-
C81	PEG_RX9+	PCI Express Graphics Receive Lane 9 Positive	DP-I		
C82	PEG_RX9-	PCI Express Graphics Receive Lane 9 Negative	DP-I		
C83	RSVD	Reserved	Not connected	nc	nc
C84	GND	Power Ground	PWR	-	-
C85	PEG_RX10+	PCI Express Graphics Receive Lane 10 Positive	DP-I		
C86	PEG_RX10-	PCI Express Graphics	DP-I		

Pin	Signal	Description	Type	Termination	Comment
		Receive Lane 10 Negative			
C87	GND	Power Ground	PWR	-	-
C88	PEG_RX11+	PCI Express Graphics Receive Lane 11 Positive	DP-I		
C89	PEG_RX11-	PCI Express Graphics Receive Lane 11 Negative	DP-I		
C90	GND (Fixed)	Power Ground	PWR	-	-
C91	PEG_RX12+	PCI Express Graphics Receive Lane 12 Positive	DP-I		
C92	PEG_RX12-	PCI Express Graphics Receive Lane 12 Negative	DP-I		
C93	GND	Power Ground	PWR	-	-
C94	PEG_RX13+	PCI Express Graphics Receive Lane 13 Positive	DP-I		
C95	PEG_RX13-	PCI Express Graphics Receive Lane 13 Negative	DP-I		
C96	GND	Power Ground	PWR	-	-
C97	RSVD	Reserved	Not connected	nc	nc
C98	PEG_RX14+	PCI Express Graphics Receive Lane 14 Positive	DP-I		
C99	PEG_RX14-	PCI Express Graphics Receive Lane 14 Negative	DP-I		
C100	GND (Fixed)	Power Ground	PWR	-	-
C101	PEG_RX15+	PCI Express Graphics Receive Lane 15 Positive	DP-I		
C102	PEG_RX15-	PCI Express Graphics Receive Lane 15 Negative	DP-I		
C103	GND	Power Ground	PWR	-	-
C104	VCC_12V	12V VCC	PWR	-	-
C105	VCC_12V	12V VCC	PWR	-	-
C106	VCC_12V	12V VCC	PWR	-	-
C107	VCC_12V	12V VCC	PWR	-	-
C108	VCC_12V	12V VCC	PWR 8	-	-

Pin	Signal	Description	Type	Termination	Comment
C109	VCC_12V	12V VCC	PWR	-	-
C110	GND (Fixed)	Power Ground	PWR	-	-

NOTE: The termination resistors in this table are already mounted on the microETXexpress® board. Refer to the PICMG COM Express® Design Guide for information about additional termination resistors.

Table 6: Connector X1B - Row D

Pin	Signal	Description	Type	Termination	Comment
D1	GND (Fixed)	Power Ground	PWR	-	-
D2	GND	Power Ground	PWR	-	-
D3	USB_SSTX0-	SuperSpeed USB Data Transmit Path 0-	Not connected	nc	nc
D4	USB_SSTX0+	SuperSpeed USB Data Transmit Path 0+	Not connected	nc	nc
D5	GND	Power Ground	PWR	-	-
D6	USB_SSTX1-	SuperSpeed USB Data Transmit Path 1-	Not connected	nc	nc
D7	USB_SSTX1+	SuperSpeed USB Data Transmit Path 1+	Not connected	nc	nc
D8	GND	Power Ground	PWR	-	-
D9	USB_SSTX2-	SuperSpeed USB Data Transmit Path 2-	Not connected	nc	nc
D10	USB_SSTX2+	SuperSpeed USB Data Transmit Path 2+	Not connected	nc	nc
D11	GND (Fixed)	Power Ground	PWR	-	-
D12	USB_SSTX3-	SuperSpeed USB Data Transmit Path 3-	Not connected	nc	nc
D13	USB_SSTX3+	SuperSpeed USB Data Transmit Path 3+	Not connected	nc	nc
D14	GND	Power Ground	PWR	-	-
D15	DDI1_CTRLCLK_AUX+	HDMI/DVI I ² C CTRLCLK	I/O-3.3	-	-
D16	DDI1_CTRLDATA_AUX-	HDMI/DVI I ² C CRTLDATA	I/O-3.3	-	-

Pin	Signal	Description	Type	Termination	Comment
D17	RSVD	Reserved	Not connected	nc	nc
D18	RSVD	Reserved	Not connected	nc	nc
D19	PCIE_TX6+	PCI Express Differential Transmit Pair 6+	DP-0		
D20	PCIE_TX6-	PCI Express Differential Transmit Pair 6-	DP-0		
D21	GND (Fixed)	Power Ground	PWR	-	-
D22	PCIE_TX7+	PCI Express Differential Transmit Pair 7+	Not connected	nc	nc
D23	PCIE_TX7-	PCI Express Differential Transmit Pair 7-	Not connected	nc	nc
D24	RSVD	Reserved	Not connected	nc	nc
D25	RSVD	Reserved	Not connected	nc	nc
D26	DDI1_PAIR0+	Digital Display Interface	DP-0		
D27	DDI1_PAIR0-	Digital Display Interface	DP-0		
D28	RSVD	Reserved	Not connected	nc	nc
D29	DDI1_PAIR1+	Digital Display Interface1+	DP-0		
D30	DDI1_PAIR1-	Digital Display Interface1-	DP-0		
D31	GND (FIXED)	Power Ground	PWR	-	-
D32	DDI1_PAIR2+	Digital Display Interface2+	DP-0		
D33	DDI1_PAIR2-	Digital Display Interface2-	DP-0		
D34	DDI1_DDC_AUX_SEL	Selects function of DDI CTRL & DATA Aux	I-3.3		
D35	RSVD	Reserved			
D36	DDI1_PAIR3+	Digital Display Interface3+	DP-0		
D37	DDI1_PAIR3-	Digital Display Interface3-	DP-0		
D38	RSVD	Reserved	-	-	-
D39	DDI2_PAIR0+	Digital Display Interface0+	DP-0		
D40	DDI2_PAIR0-	Digital Display Interface0-	DP-0		

Pin	Signal	Description	Type	Termination	Comment
D41	GND (FIXED)	Power Ground	PWR	-	-
D42	DDI2_PAIR1+	Digital Display Interface1+	DP-0		
D43	DDI2_PAIR1-	Digital Display Interface1-	DP-0		
D44	DDI2_HPD	Digital Display Interface Hot-Plug Detect	I-3.3		
D45	RSVD	Reserved	Not connected	nc	nc
D46	DDI2_PAIR2+	Digital Display Interface2+	DP-0		
D47	DDI2_PAIR2-	Digital Display Interface2-	DP-0		
D48	RSVD	Reserved	Not connected	nc	nc
D49	DDI2_PAIR3+	Digital Display Interface3+	DP-0		
D50	DDI2_PAIR3-	Digital Display Interface3-	DP-0		
D51	GND (Fixed)	Power Ground	PWR	-	-
D52	PEG_TX0+	PCI Express Graphics Transmit Data Lane 0 Positive	DP-0		
D53	PEG_TX0-	PCI Express Graphics Transmit Data Lane 0 Negative	DP-0		
D54	PEG_LANE_RV#	PCI Express Graphics Lane Reversal Input strap	I-3.3		
D55	PEG_TX1+	PCI Express Graphics Transmit Data Lane 1 Positive	DP-0		
D56	PEG_TX1-	PCI Express Graphics Transmit Data Lane 1 Negative	DP-0		
D57	TYPE2#	Not connected for Type 6 module	Not Connected	nc	nc
D58	PEG_TX2+	PCI Express Graphics Transmit Data Lane 2 Positive	DP-0		
D59	PEG_TX2-	PCI Express Graphics Transmit Data	DP-0		

Pin	Signal	Description	Type	Termination	Comment
		Lane 2 Negative			
D60	GND (Fixed)	Power Ground	PWR	-	-
D61	PEG_TX3+	PCI Express Graphics Transmit Data Lane 3 Positive	DP-0		
D62	PEG_TX3-	PCI Express Graphics Transmit Data Lane 3 Negative	DP-0		
D63	RSVD	Reserved	Not connected	nc	nc
D64	RSVD	Reserved	Not connected	nc	nc
D65	PEG_TX4+	PCI Express Graphics Transmit Data Lane 4 Positive	DP-0		
D66	PEG_TX4-	PCI Express Graphics Transmit Data Lane 4 Negative	DP-0		
D67	GND	Power Ground	PWR	-	-
D68	PEG_TX5+	PCI Express Graphics Transmit Data Lane 5 Positive	DP-0		
D69	PEG_TX5-	PCI Express Graphics Transmit Data Lane 5 Negative	DP-0		
D70	GND (Fixed)	Power Ground	PWR	-	-
D71	PEG_TX6+	PCI Express Graphics Transmit Data Lane 6 Positive	DP-0		
D72	PEG_TX6-	PCI Express Graphics Transmit Data Lane 6 Negative	DP-0		
D73	GND	Power Ground	PWR		
D74	PEG_TX7+	PCI Express Graphics Transmit Data Lane 7 Positive	DP-0	-	-
D75	PEG_TX7-	PCI Express Graphics Transmit Data Lane 7 Negative	DP-0	-	-
D76	GND	Power Ground	PWR	-	-

Pin	Signal	Description	Type	Termination	Comment
D77	RSVD	Reserved	Not connected	nc	nc
D78	PEG_TX8+	PCI Express Graphics Transmit Data Lane 8 Positive	DP-O		
D79	PEG_TX8-	PCI Express Graphics Transmit Data Lane 8 Negative	DP-O		
D80	GND (Fixed)	Power Ground	PWR	-	-
D81	PEG_TX9+	PCI Express Graphics Transmit Data Lane 9 Positive	DP-O		
D82	PEG_TX9-	PCI Express Graphics Transmit Data Lane 9 Negative	DP-O		
D83	RSVD	Reserved	Not connected	nc	nc
D84	GND	Power Ground	PWR	-	-
D85	PEG_TX10+	PCI Express Graphics Transmit Data Lane 10 Positive	DP-O		
D86	PEG_TX10-	PCI Express Graphics Transmit Data Lane 10 Negative	DP-O		
D87	GND	Power Ground	PWR	-	-
D88	PEG_TX11+	PCI Express Graphics Transmit Data Lane 11 Positive	DP-O		
D89	PEG_TX11-	PCI Express Graphics Transmit Data Lane 11 Negative	DP-O		
D90	GND (Fixed)	Power Ground	PWR	-	-
D91	PEG_TX12+	PCI Express Graphics Transmit Data Lane 12 Positive	DP-O		
D92	PEG_TX12-	PCI Express Graphics	DP-O		

Pin	Signal	Description	Type	Termination	Comment
		Transmit Data Lane 12 Negative			
D93	GND	Power Ground	PWR	-	-
D94	PEG_TX13+	PCI Express Graphics Transmit Data Lane 13 Positive	DP-O		
D95	PEG_TX13-	PCI Express Graphics Transmit Data Lane 13 Negative	DP-O		
D96	GND	Power Ground	PWR	-	-
D97	RSVD	Reserved	--	--	--
D98	PEG_TX14+	PCI Express Graphics Transmit Data Lane 14 Positive	DP-O		
D99	PEG_TX14-	PCI Express Graphics Transmit Data Lane 14 Negative	DP-O		
D100	GND (Fixed)	Power Ground	PWR	-	-
D101	PEG_TX15+	PCI Express Graphics Transmit Data Lane 15 Positive	DP-O		
D102	PEG_TX15-	PCI Express Graphics Transmit Data Lane 15 Negative	DP-O		
D103	GND	Power Ground	PWR	-	-
D104	VCC_12V	12V VCC	PWR	-	-
D105	VCC_12V	12V VCC	PWR	-	-
D106	VCC_12V	12V VCC	PWR	-	-
D107	VCC_12V	12V VCC	PWR	-	-
D108	VCC_12V	12V VCC	PWR	-	-
D109	VCC_12V	12V VCC	PWR	-	-
D110	GND (Fixed)	Power Ground	PWR	-	-

NOTE: The termination resistors in this table are already mounted on the microETXexpress® board. Refer to the PICMG COM Express® Design Guide for information about additional termination resistors.

Figure 5: Onboard Connectors

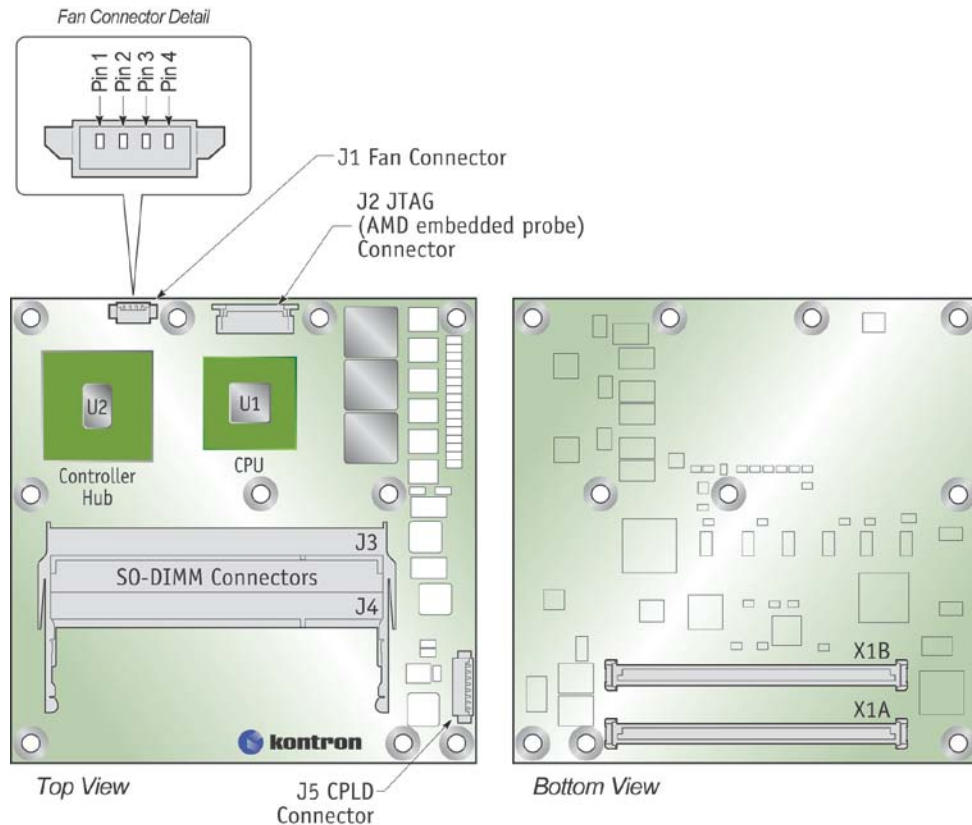

0H004

4.1.2 Connector J1 - Fan

J1 is a connector for 3- or 4-wire fan control. By default, it is set for 4-wire fan control. The 9W APU COMe-cOH# SKUs do not require a fan to function fully in the 0°C to 60° temperature range. When active cooling is required, the default population is the 4-wire fan option. See Section 6.3, "Onboard Fan Connector" for more detailed information.

Table 7. J1 Fan Connector Pin-Out

Pin	Name
1	FAN_TACH
2	FAN_V_IN
3	FAN_GND

4	V_V5
---	------

4.1.3 Connector J2 - JTAG (AMD Embedded Probe)

J2 is a 22-pin flat foil connector (FFC) used to support the AMD Embedded Probe Header interface definition.

NOTE: A cable adapter must be used to connect a Sage debugger tool to the debug connector.

Table 8. J5 JTAG Connector Pin-Out

Pin	Name
1	GND1
2	DBRDY
3	GND2
4	TDO
5	GND3
6	TDI
7	GND4
8	TMS
9	GND5
10	TCK
11	GND6
12	DBREQ
13	PWRBTN
14	1.8V
15	SYSRST#
16	GND7
17	LDTRST#
18	GND8
19	SCLK
20	GND9
21	SDAT
22	GND10

WARNING: The debug port is for internal use only. Do not connect any devices.

4.1.4 Connectors J3 and J4 - SO-DIMM DDR3 Memory Sockets

This design supports up to 8 GBytes (single channel, 4 GBytes each) of DDR3 memory.

4.1.5 Connector J5 -CPLD

TBD

4.1.6 PCI Express Interface

The PCI Express*1.0 or 2.0 general purpose lanes provide a fast connection interface for many different system devices, such as network controllers, I/O controllers or express card devices. The implementation of this subsystem complies with the ETXexpress® COM Express Specification. Refer to the PICMG COM Express® Design Guide for additional implementation information.

The COMe-cOH# COM supports up to 6 PCI Express lanes. PCIe lanes 0 - 3 are software-configurable as x4, x2, or x1. PCIe lanes 4 - 5 are software configurable as x1 or x2. See Table 9 for detailed configuration information.

Table 9: PCI Express Configuration (TBD)

Source 1	Optional	Standard	Target
AMD FCH			
AMD FCH			
-			
-			
-			
-			
-			
-			

4.1.7 USB Interface

The USB interface supports both USB 2.0 and USB 3.0 (new with COM Express Type 6).

USB 2.0 Interface

Eight high speed USB 2.0 ports are brought from the Fusion Control Hub to the COM Express A-B connector. The FCH employs three EHCI controllers. The eight COM Express USB ports are distributed with two EHCI controllers serving three COM Express ports each and the third EHCI controller serving the remaining two COM Express ports.

Table 10 shows how the eight USB 2.0 ports are used for USB configuration in the COMe-cOH# module.

USB 3.0 Interface

Two super speed USB 3.0 ports can be implemented on COM Express connector C-D, USB ports 0 and 1. These two ports are supported using a Renesas uPD720200A USB 3.0 Host Controller as a PCIe 2.0 to USB 3.0 bridge.

Table 10: USB Configuration

COM Express™ Port	FCH USB 2.0 Port	USB 3.0 Host Controller	Description
USB0	USB0 N/A	N/A USB1	USB 2.0 (EHC0) Type-2 USB 3.0 Type-6
USB1	USB5 N/A	N/A USB2	USB 2.0 (EHC1) Type-2 USB 3.0 Type-6
USB2	USB10	N/A	USB 2.0 (EHC2)
USB3	USB1	N/A	USB 2.0 (EHC0)
USB4	USB6	N/A	USB 2.0 (EHC1)
USB5	USB11	N/A	USB 2.0 (EHC2)
USB6	USB2	N/A	USB 2.0 (EHC0)
USB7	USB7	N/A	USB 2.0 (EHC1)

Figure 6 shows the internal USB 2.0 mapping from the AMD FCH.

Figure 6: USB Mapping

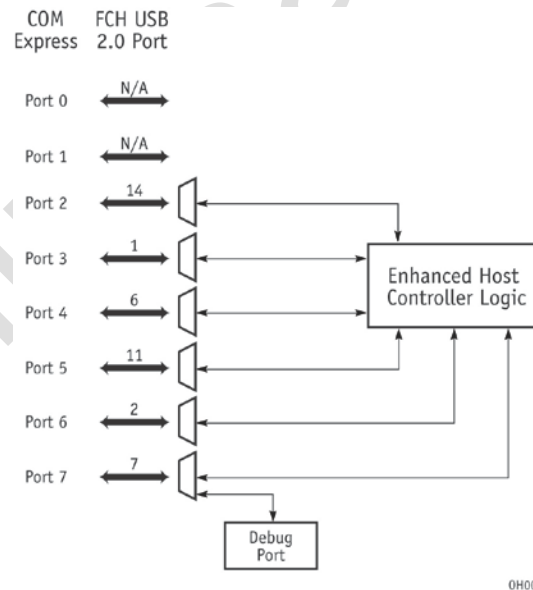

NOTE: Additional USB connections can be added using external USB hubs.

Configuration

The USB controllers are PCIe bus devices

The BIOS allocates the required system resources during configuration of the PCIe bus.

4.1.8 SATA Interface

Four of the AMD Fusion Control Hub SATA 2.0 channels are routed to the four COM Express SATA channels. The FCH SATA 0-3 ports map to the COM Express SATA 0-3 pins.

Configuration

The SATA controller is a PCIe bus device. The BIOS allocates the required system resources during the PCIe device configuration.

4.1.9 Audio Interface

The AMD Fusion Control Hub supports High Definition Audio (HDA). This HD audio configuration supports three audio channels.

Configuration

The audio controller is in the AMD FCH. The BIOS allocates the required system resources during configuration.

4.1.10 Serial IRQ

The serial IRQ pin (A50) offers a standardized interface to link interrupt request lines to a single wire.

Configuration

The serial IRQ machine is in "Continuous Mode".

4.1.11 Graphics Interface

The COMe-cOH# uses a graphics controller that is integrated in the AMD APU. The graphics engine supports multiple display types (LVDS, single analog VGA, two digital display interfaces, DDI-0 and DDI-1, for DP and HDMI/DVI-I, DVI-D, HDTV, and CRT), and resolutions up to 2560x1200x60 Hz.

Analog VGA

The analog VGA graphics core, with a maximum resolution of 2560x1600x60Hz, is integrated in the processor and is connected to the Com Express connector A-B.

LVDS Flat Panel Interface (Type 6)

On modules with Type 6 COM Express connectors, the AMD processor has an integrated LVDS 18-bit single channel. The processor LVDS channel A is multiplexed to share two outputs; the 18-bit LVDS channel to COM Express LVDS A and a Digital Display Interface (DDI) to COM Express DDI 2.

LVDS Flat Panel Interface (Type2)

On modules with Type 2 COM Express connectors, Display Port 0 (DP0) provides 24-bit, dual-channel, LVDS-to-COM Express LVDS channels A and B using an Analogix ANX3110 DP-to-LVDS converter.

4.1.12 Ethernet Interface

The Ethernet interface on the COMe-cOH# COM is the Intel® 82574L GbE Controller. Per the COM Express specification, the LAN magnetics are not on the module. The GbE controller PHY is located close to the COM Express MDI LAN interconnect pins to keep the MDI path short. The controller supports auto-negotiation of 10/100/1000 Mbit connections.

The hardware supports S0, S3, or S5 power under BIOS to support WOL (WakeOnLAN).

For cable lengths and termination on your baseboard, refer to the PICMG *COM Express® Design Guide* on the PICMG website.

Configuration

The Ethernet controller is a PCI Express bus device. The BIOS allocates the required system resources during the configuration of the PCIe device.

4.1.13 SPI Bus Interface

The Serial Peripheral Interface (SPI) signals are connected to the COM Express connector A-B from the AMD Fusion Controller Hub. SPI BIOS is supported at the maximum level the FCH supports, 16 MBytes. Two BIOS disable straps, as defined in the COM Express Rev 2.0 specification, allow the selection of either on-module SPI BIOS or carrier board SPI or LPC BIOS. The SPI interface can be used to connect two carrier board devices, including external BIOS flash memory. The implementation of this subsystem complies

with the COM Express Rev 2.0 specification. Carrier Board SPI boot support is new with COM Express Rev 2.0. For additional implementation information, refer to the *PICMG COM Express® Design Guide* on the PICMG website

4.1.14 LPC Bus Interface

The Low Pin Count (LPC) interface signals are connected to the AMD Fusion Controller Hub. The LPC low-speed interface can be used for peripheral circuits. For example, it can be used as an external super I/O controller to combine legacy-device support into a single IC. The implementation of this subsystem complies with the COM Express™ specification. For additional implementation information, refer to the *PICMG COM Express® Design Guide* on the PICMG website.

Table 11: LPC Addresses

Address (HEX)	Device
0000 - 00FF	IBM PC compatible devices (IRQ-Controller, Keyboard, RTC, etc.)
002E-002F	Optional: Super I/O W83627
004e - 004f	TPM
01F0 - 01F7	Fixed Disk
03C0 - 03CF	VGA/EGA compatible registers
03F6	Fixed Disk
0400 - 043F	SMBus
0480 - 04BF	GPIO ICH
04D0 - 04D1	IRQ Configuration
08F0 - 08FF	Optional
0900 - 091F	Power Management
0A80 - 0A83	Reserved
0CF8 - 0CFF	PCI Configuration
D880 - D887	PCI LAN Controller *
E080 - E09F	PCI USB Controller *
E480 - E49F	PCI USB Controller *
E880 - E887	PCI VGA Controller *
EF00 - EF1F	PCI USB Controller*
FFA0 - FFAF	PCI IDE Controller *

* = not fixed, configured by the BIOS automatically and may be different in other system configurations.

4.1.15 Power Control Interface

VCC_12V is allowed to range from 4.75V to 18V. This range is above and beyond the requirements of the COM Express specification.

Power Good (PWR_OK)

The COMe-cOH# COM provides an external input for a power-good signal (pin B24). The implementation of this subsystem complies with the COM Express® Specification. PWR_OK is internally pulled up to 3.3V and must be sampled as logic high to power on the module.

Power Button (PWRBTN#)

The power button (pin B12) is available through the module connector as defined in the COM Express connector pin-out list.

To power-off the module, press and hold the power button for at least four seconds.

Reset Button (SYS_RESET#)

The reset button (pin B49) is available through the module connector as defined in the pin-out list. The module stays in reset as long as SYS_RESET# is grounded.

Power Supply

The COMe-cOH# COM has a wide range of power inputs, from 4.75V to 18V DC. The supply voltage is applied through the VCC pins on the module connector. In ATX mode the 5V standby voltage range is from 4.75V to 5.25V. RTC power is provided on the VCC RTC pins. VCC_12V may or may not collapse in suspend states S3, S4, S5

ATX Mode / Single Supply Mode

ATX Mode:

When an ATX power supply is connected, PWR_OK is set to low-level and VCC is off. Pressing the power button enables the ATX PSU setting PWR_OK to high-level and powers on VCC. The ATX PSU is controlled by the PS_ON# signal, which is generated by SUS_S3#.

Table 12: ATX Mode

State	PWRBTN#	PWR_OK	V5_StdBy	PS_ON#	VCC
S3	x	x	0V	x	0V
S5	high	low	5V	high	0V
S5 -> S0	PWRBTN Event	low -> high	5V	high -> low	0 V-> VCC
S0	high	high	5V	low	VCC

Single Supply Mode:

Main power is provided on the COM Express VCC_12V pins. Standby power, if needed, is also provided on the VCC_12V pins. The VCC_5V_SBY pins may be floating or may be tied to a 5V source on the Carrier. RTC power is provided on the VCC_RTC pins

To power on the module from the S5 state, press the power button or reconnect VCC.

Table 13: Single Supply Mode

State	PWRBTN#	PWR_OK	V5_StdBy	VCC
S3	x	x	x	0
S3 -> S0	high	open / high	x	connecting VCC
S5	high	open / high	x	VCC
S5 -> S0	PWRBTN Event	open / high	x	reconnecting VCC

NOTES: 1) Columns marked "x" are not relevant for the specified power state.
2) All ground pins have to be tied to the ground plane of the carrier board.

4.1.16 Miscellaneous Circuits

Speaker

The implementation of this subsystem complies with the COM Express® Specification. For additional implementation information, refer to the PICMG COM Express® Design Guide.

Battery

The implementation of this subsystem complies with the COM Express® specification. For additional implementation information, refer to the *PICMG COM Express® Design Guide* on the PICMG website.

The COM Express® Rev 2.0 specification requires the carrier board and the module to have two current-limiting devices (resistor and diode) between the battery and the consuming component.

I²C Bus

The I²C bus implementation supports on- and off-module use. I²C is configured to use one of the SMBus ports on the Fusion Controller Hub. The I²C implementation is an I²C master with 7-bit I²C addressing, capable of 100 KHz or 400 KHz operation.

COM Express Rev 2 specifies I²C on the standby rail now, so in the S5 state a carrier board I²C master can query the module. The COMe-cOH# module I²C bus is multi-master capable.

For additional information, refer to the *PICMG COM Express® Design Guide* on the PICMG website and I²C application notes, which are available on the Kontron website at <http://emdcustomersection.kontron.com/>.

See Chapter 8, "BIOS Operation" for supported I²C features.

SMBus

System Management Bus (SMBus) signals are connected to the SMBus controller, which is located on the AMD Fusion Controller Hub. The SMBus is a 2-wire, bi-directional bus (clock and serial data) used for system management tasks such as reading parameters from a memory card or reading temperatures and voltages of system components.

The implementation complies with the COM Express® specification. For additional implementation information, refer to the *PICMG COM Express® Design Guide* on the PICMG website

5 Special Features

5.1 Watchdog Timer (WDT)

The watchdog timer is managed via the super I/O component, the Nuvoton NCT5577D.

The implementation complies with the COM Express® specification. Timer modes 1, 2, and 3 are supported. For additional implementation information, refer to the *PICMG COM Express® Design Guide* on the PICMG website

5.2 General Purpose Input and Output (GPIO)

The COMe-cOH# COM provides four interrupt-capable general purpose inputs and four general purpose outputs that can be accessed through the module connector described in the pin-out lists, in Section 4.1. The GPIO interface can be enabled in the BIOS setup.

Table 14: GPIO COM Express Pin-Outs

Bit of GPIO Port0	Function	COM Express Pin
0	GPI0	A54
1	GPI1	A63
2	GPI2	A67
3	GPI3	A85
4	GPO0	A93
5	GPO1	B54
6	GPO2	B57
7	GPO3	B63

5.3 ACPI Suspend Modes and Resume Events

The COMe-cOH# COM supports the following suspend modes:

- » S0 (Normal on)
- » S3 (Suspend to RAM)
- » S4 (Suspend to Disk)
- » S5 /WOL(soft-off, WOL enabled)
- » S5 (soft-off, WOL disabled)
- » S5 ECO deep soft-off

NOTE: The S5 ECO state is an ultra low power state in which the module power draw from the available supplies (VCC_12V and/or optional VCC_5V_SBY) is under **TBD** mW.

In addition to these Suspend modes, all AMD defined 'C' states for power savings are supported.

Events that Resume the System from S3

- » USB keyboard (1)
- » USB mouse (1)
- » Power button
- » WakeOnLan (2)

Events that Resume the System from S4/S5

- » Power button
- » WakeOnLan

NOTES:

- 1) The OS must support wake-up via USB devices and the baseboard must power the USB port with StandBy-Voltage
- 2) WakeOnLan must be enabled in the driver options.
- 3) Wake from S5 ECO is enabled "on" by the power button.

6 Design Considerations

6.1 Thermal Management

An optional heat spreader plate assembly is available from Kontron Embedded Modules for the COMe-cOH# COM. The heat spreader plate on top of this assembly is NOT a heat sink. It works as a COM Express®-standard thermal interface to be used with a heat sink or other cooling device.

External cooling must be provided to maintain the heat spreader plate at proper operating temperatures. Under worst-case conditions, the cooling mechanism must maintain an ambient air and heat spreader plate temperature of 60° C or less.

The aluminum slugs and thermal pads on the underside of the heat spreader assembly implement thermal interfaces between the heat spreader plate and the major heat-generating components on the COMe-cOH#. About 80 percent of the power dissipated within the module is conducted to the heat spreader plate and can be removed by the cooling solution.

Kontron also has defined a passive heat sink that can be used in place of the heat spreader plate to provide additional cooling. You can use many thermal-management solutions with the heat spreader plates, including active and passive approaches. The optimum cooling solution varies, depending on the COM Express® application and environmental conditions and the module is fully functional at the full -40C to +85C temperature even without the heat spreader plate or the passive heat sink. Drawings for both the heat spreader plate and the passive heat sink are available on request. Also, see the *PICMG COM Express® Design Guide* on the PICMG website for further information about thermal management.

6.2 Heat Spreader Dimensions

Documentation for the COMe-cOH# COM heat spreader and cooling solutions is provided at <http://emdcustomersection.kontron.com>.

6.3 Onboard Fan Connector

This section describes how to connect an optional fan for active cooling to a header located directly on the COMe-cOH# COM.

Figure 7: Fan Connector (J1) Location and Pin-Out

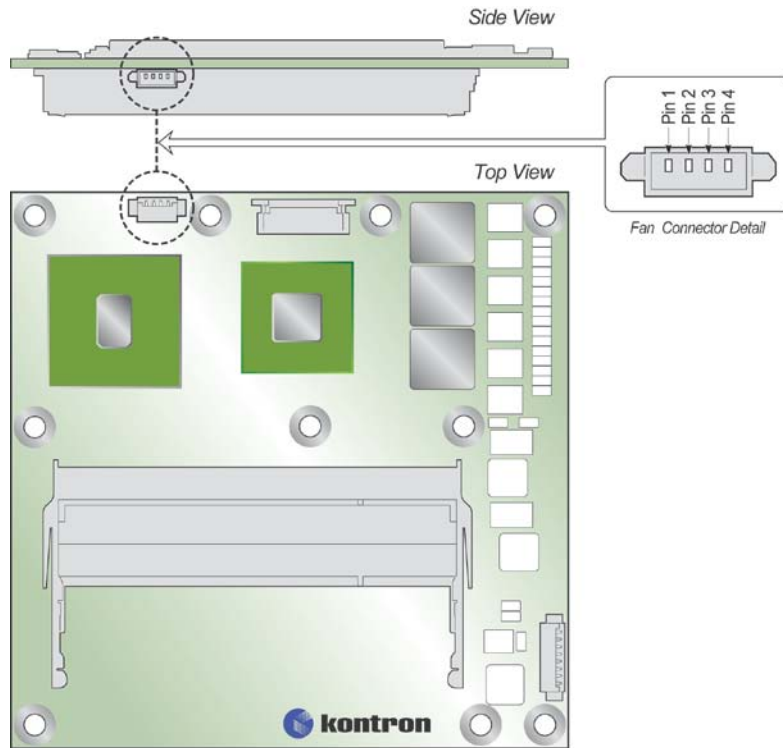

0H008

The onboard fan connector (J1) is on the left top side of the PCB. The connection details are covered in the Figure 8 schematic.

Table 15: Fan Connector (J1) Pin-Out

Pin	Description
1	FAN_GND
2	FAN_12V_VCC
3	CPU_FAN_TACH_CONN
4	CPU_FAN_PWM_CONN

Figure 8: Fan Connector Schematic

To be supplied in a future version of this manual.

Connector J1 specifications and Kontron part numbers for the components are:

- » Part number: (Molex) 52435-2472
- » Mates with: (Molex) 51021-0400
- » Crimp terminals: (Molex) 50079-80000 (26-28 AWG)

6.3.1 Fan Connector Electrical Characteristics

The fan connector supply pin is connected directly to the VCC_12V supply from the COM Express connector

CAUTION: Be aware of the wide range of input voltages and acceptable fan voltages and ensure that the fan you select supports the applied voltage.

The maximum current supported on that output is 125mA @ 60°C ambient because it is current limited by a resettable fuse. The voltage is not limited to +12V on this pin.

7 System Resources

7.1 Interrupt Request (IRQ) Lines

Tables showing IRQ number assignments will be supplied in a future version of this manual.

7.2 Memory Area

The first 640 KBytes of DRAM are used as main memory. With DOS, you can address 1 MByte of memory directly. The memory area above 1 MByte (high memory, extended memory) is accessed under DOS with special drivers such as HIMEM.SYS and EMM386.EXE, which are part of the operating system. See the operating system documentation or special textbooks for information about HIMEM.SYS and EMM386.EXE.

Other operating systems (Linux or Windows versions) allow you to address the full memory area directly.

Upper Memory	Used for	Available	Comment
A0000h - BFFFFh	VGA Memory	No	Mainly used by graphic controller
C0000h - CFFFFh	VGA BIOS	No	Used by onboard VGA ROM
D0000h - DFFFFh		Yes	Free for shadow RAM in standard configurations.
E0000h - FFFFFh	System BIOS	No	Fixed

7.3 I/O Address Map

The I/O-port addresses of the COMe-cOH# COM are functionally identical to those of a standard PC/AT system. All addresses not mentioned in Table 16 should be available. For compatibility reasons, we recommend that you do not use I/O addresses below 0100h for additional hardware, even if they are available.

Table 16: I/O Address Assignments

I/O Address	Used for	Available	Comment
0000 - 001F	System Resources	No	Fixed
0020 - 003F	Interrupt Controller 1	No	Fixed
002E - 002F	Winbond driver	No	Fixed if W83627HG is in system
0040 - 005F	Timer, Counter	No	Fixed
004E - 004F	TPM	No	Fixed if TPM is in

I/O Address	Used for	Available	Comment
			system
0060 - 006F	Keyboard Controller	No	Fixed
0070 - 007F	RTC and CMOS Registers	No	Fixed
0080	BIOS Postcode	No	Fixed
0081 - 008F	DMA Page Register	No	Fixed
00A0 - 00BF	Interrupt Controller 2	No	Fixed
00C0 - 00DF	DMA Controller 2	No	Fixed
00E0 - 00EF	System Control	No	Fixed
00F0 - 00FF	Math Coprocessor	No	Fixed
0170 - 0177 0376	Fixed Disk	No	Available if IDE port 1 is disabled
01F0 - 01F7 03F6	Fixed Disk	No	Available if IDE port 1 is disabled
0290-0295	SIO HWM	No	Fixed if NCT5577D SIO is in system
03B0 - 03DF	VGA	No	Fixed
0400 - 043F	SMBus	No	Fixed
0480 - 04BF	GPIO	No	Fixed
04D0 - 04D1	PIC Extension	No	Fixed
0900 - 091F	Power Management	No	Fixed
09C0 - 09FF	GPE	No	Fixed
0A05 - 0A06	Hardware Monitor	No	Fixed if HWM is in system
0A80 - 0A81	CPLD	No	in Future versions
C000 - CFFF	PCIe-to-PCI Bridge	No	Dynamic (BIOS default address)
0CF8 - 0CFF	PCI Configuration	No	Fixed
D000 - DFFF	PCIe-to-PCI bridge	No	Dynamic (BIOS default address)
D880 - D88F	SATA Controller	No	Dynamic (BIOS default address)
E080 - E09F	PCI USB Controller	No	Dynamic (BIOS default address)
E480 - E49F	PCI USB Controller	No	Dynamic (BIOS default address)
E880 - E887	VGA	No	Dynamic (BIOS default address)
EF00 - EF1F	PCI USB Controller	No	Dynamic (BIOS default address)
FFA0 - FFAF	PCI IDE Controller	No	Dynamic (BIOS default address)

7.4 Peripheral Component Interconnect (PCI) Devices

All devices follow the PCI Express Base 1.0a specifications. The BIOS and OS control memory and I/O resources.

Table 17: PCI Device IRQs

PCI Device	PCI IRQ	Interface	Comment
Host Bridge / Memory Controller	None		Integrated in processor
Graphics / Video Controller	INTA		Integrated in processor
USB Client Controller	INTA		Integrated in chipset
HD Audio Controller	INTA		Integrated in chipset
PCI Express Port (Bridge)	INTA		Integrated in chipset
PCI Express Port (Bridge)	INTB		Integrated in chipset
UHCI USB Controller 1	INTE		Integrated in chipset
UHCI USB Controller 2	INTF		Integrated in chipset
UHCI USB Controller 3	INTG		Integrated in chipset
EHCI USB Controller	INTH		Integrated in chipset
ISA Bridge / LPC Controller	None		Integrated in chipset
IDE Controller	None		Integrated in chipset
Network Controller	INTC	PCI Express	External TBD
SATA	INTA	PCI Express	External TBD

Table 18: External I²C Bus #1

Table of addresses to be supplied in a future version of this manual

Table 19: External I²C Bus #2

Table of addresses to be supplied in a future version of this manual

7.5 System Management Bus (SMBus)

Table 20: SMBus Address Assignments

Table of addresses to be supplied in a future version of this manual

7.6 K-Station Resources

Table 21: I²C

BUS	Function
I2C 0	Internal
I2C 1	SMBus
I2C 2	Internal (for slow devices)
I2C 4	TBD

Table 22: Storage

Device	Function
EEPROM 0	EEPROM Areal with 32 Bytes (free to use)
EEPROM 1	EEPROM Area 2 with 33 Bytes (reserved)

Table 23: GPIO

Port	Function
IO-Port 0	GPIO Port, Bit 0-3: Input, Bit 4-7: Output

Table 24: Hardware Monitor

Sensor	Function
Temp 0	CPU ACPI temperature (measured with Nuvoton NCT5577D SIO HWM)
Temp 1	Module temperature (internal IC temperature of onboard HWM)
FAN 0	Module CPU fan sensor (measured with NCT5577D SIO HWM)
Voltage 0	Nuvoton NCT5577D SIO Voltage Sensor 0: CoreA
Voltage 1	Nuvoton NCT5577D SIO Voltage Sensor 1: VRAM
Voltage 2	Nuvoton NCT5577D SIO Voltage Sensor 2: +3.3V

8 BIOS Operation

The COMe-cOH# COM supports carrier board SPI devices. Carrier board SPI boot support is new with COM Express Rev 2.

8.1 Determining the BIOS Version

The COMe-cOH# COM has AMIBIOS®8 installed on the onboard 8-Mbit firmware hub. To determine the AMI® BIOS version, press the Pause key on your keyboard immediately, as soon as you see the following text display in the upper left corner of your screen:

```
» AMIBIOS © 2011, American Megatrends, Inc.
» BIOS Date: 09/22/2011 13:36:23 Ver: 2.11.1210
» Kontron® BIOS Version < EEOHR 0.09 x64>
» © Copyright 2002-2011 Kontron
```

8.2 Setup Guide

The AMIBIOS Setup Utility changes system behavior by modifying the BIOS configuration. The setup program uses a number of menus to make changes and turn features on or off.

NOTE: Selecting incorrect values may cause system boot failure. Load setup default values to recover by pressing <F9>.

8.2.1 Start AMIBIOS®8 Setup Utility

To start the AMIBIOS® setup utility, press when the following string appears during boot-up:

Press to enter Setup

The Info menu then appears.

The Setup screen has several sections:

Setup Screen	Location	Function
Menu Bar	Top	Lists and selects all top level menus.
Legend Bar	Right side bottom	Lists setup navigation keys.
Item Specific Help Window	Right side top	Help for selected item.
Menu Window	Left center	Selection fields for current menu.

Menu Bar

The menu bar at the top of the window lists different menus. Use the ← arrow key or the → arrow key to make a selection.

Legend Bar

Use the keys listed on the bottom of the legend bar to make your selections or exit the current menu. The table below describes the legend keys and their alternates.

Key	Function
<F1> or <Alt-H>	General Help window.
<Esc>	Exit menu.
← or → Arrow key	Select a menu.
↑ or ↓ Arrow key	Select fields in current menu.
<Home> or <End>	Move cursor to top or bottom of current window.
<PgUp> or <PgDn>	Move cursor to next or previous page.
<F9>	Load the default configuration values for this menu.
<F10>	Save and exit.
<Enter>	Execute command or select submenu.
<Alt-R>	Refresh screen.

Selecting an Item

Use the ↑ or ↓ key to move the cursor to the field you want. Then use the + and - keys to select a value for that field. The Save Value commands in the Exit menu save the values displayed in all the menus.

Displaying Submenus

Use the ← arrow key or the → arrow key to move the cursor to the submenu you want and then press <Enter>. A pointer (▶) marks all submenus.

Item Specific Help Window

The Help window on the right side of each menu displays the Help text for the selected item. It updates as you move the cursor through each field.

General Help Window

Pressing <F1> or <Alt-F1> on a menu brings up the General Help window that describes the legend keys and their alternates. Press <Esc> to exit the General Help window.

Preliminary Draft

8.3 BIOS Setup

NOTE: Default settings are in bold

8.3.1 Main Menu

System Language, System Date, System Time

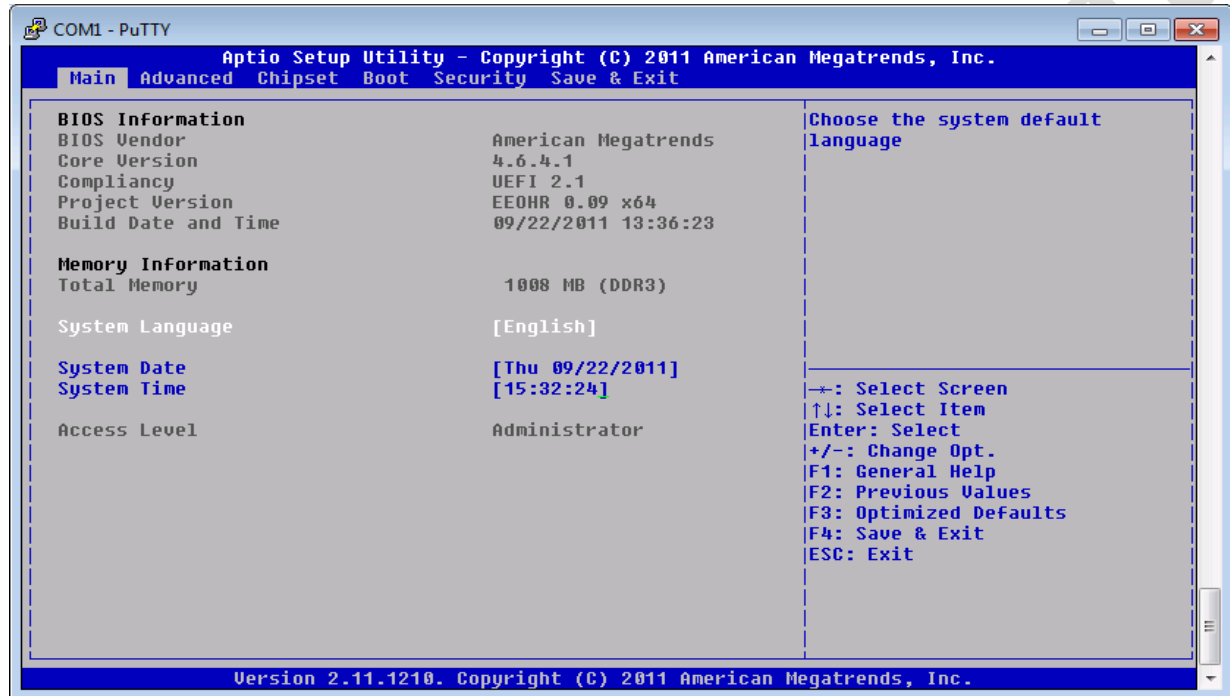

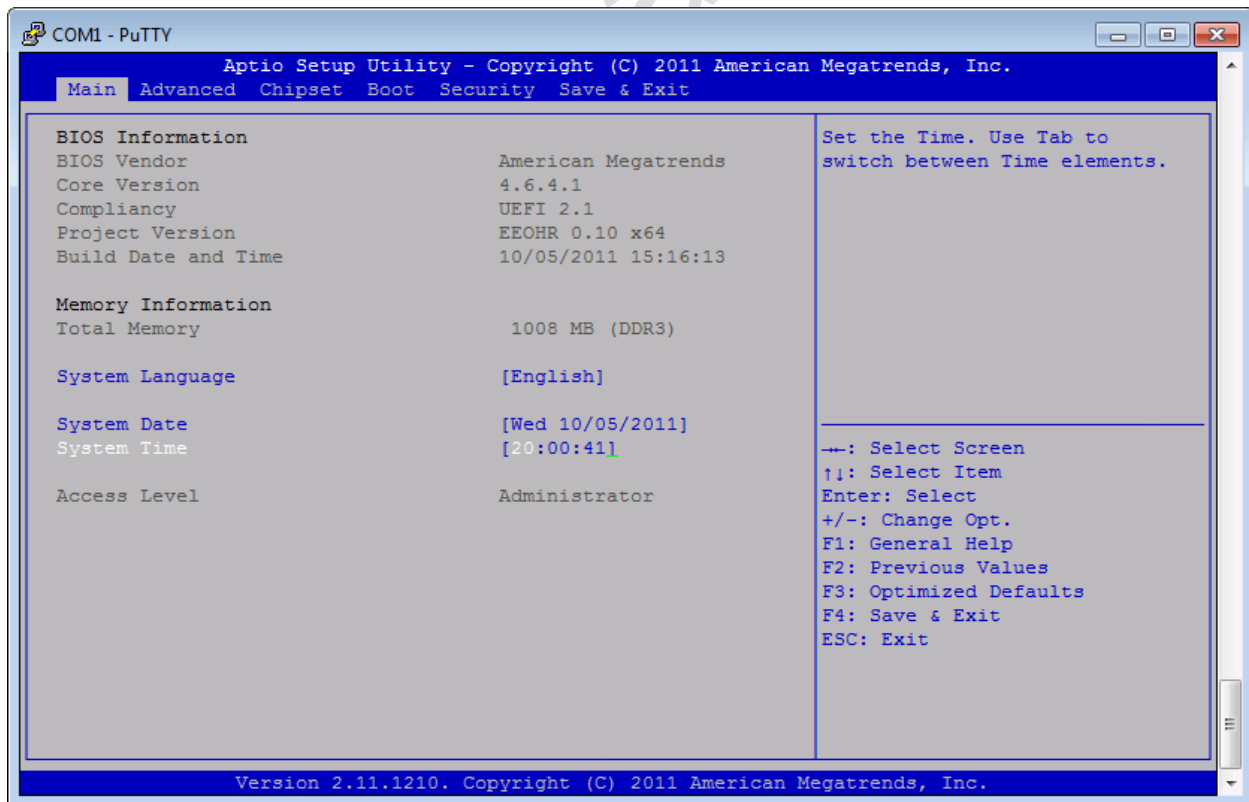
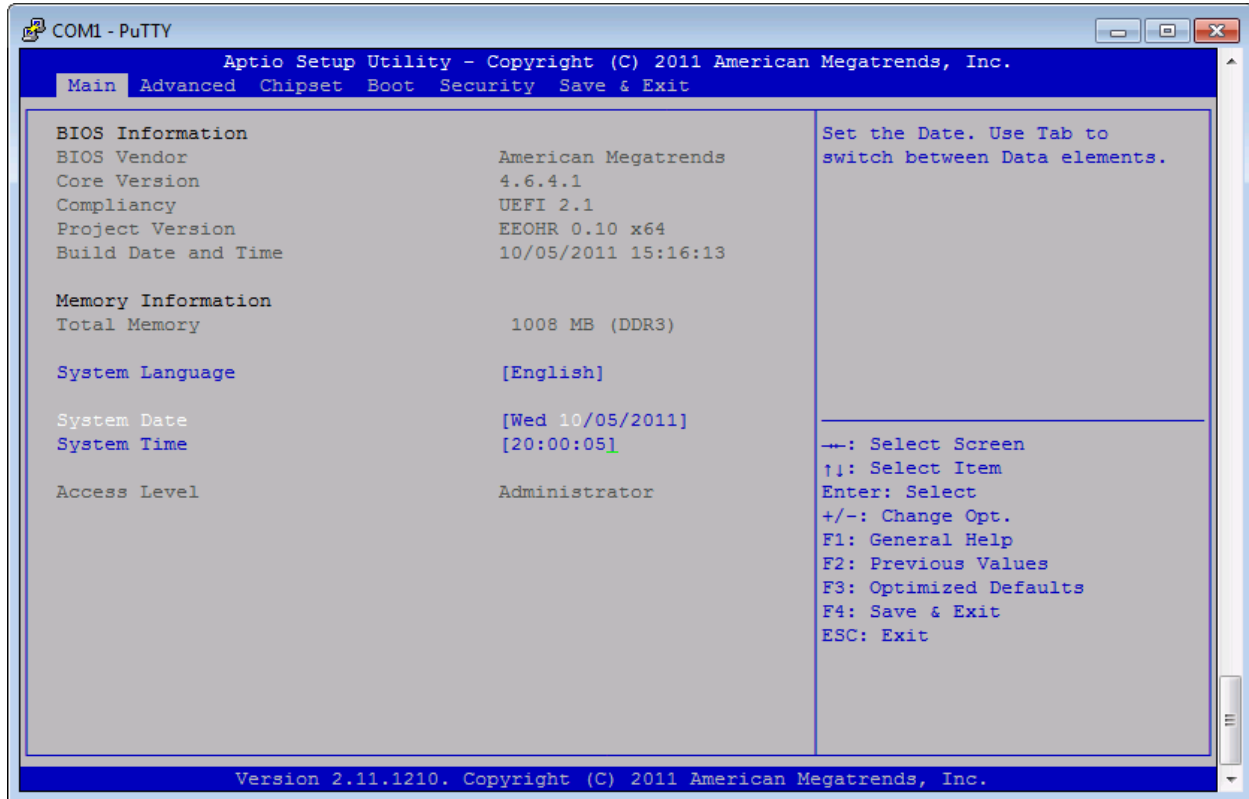

8.3.2 Advanced Menu

Launch PXE OpROM

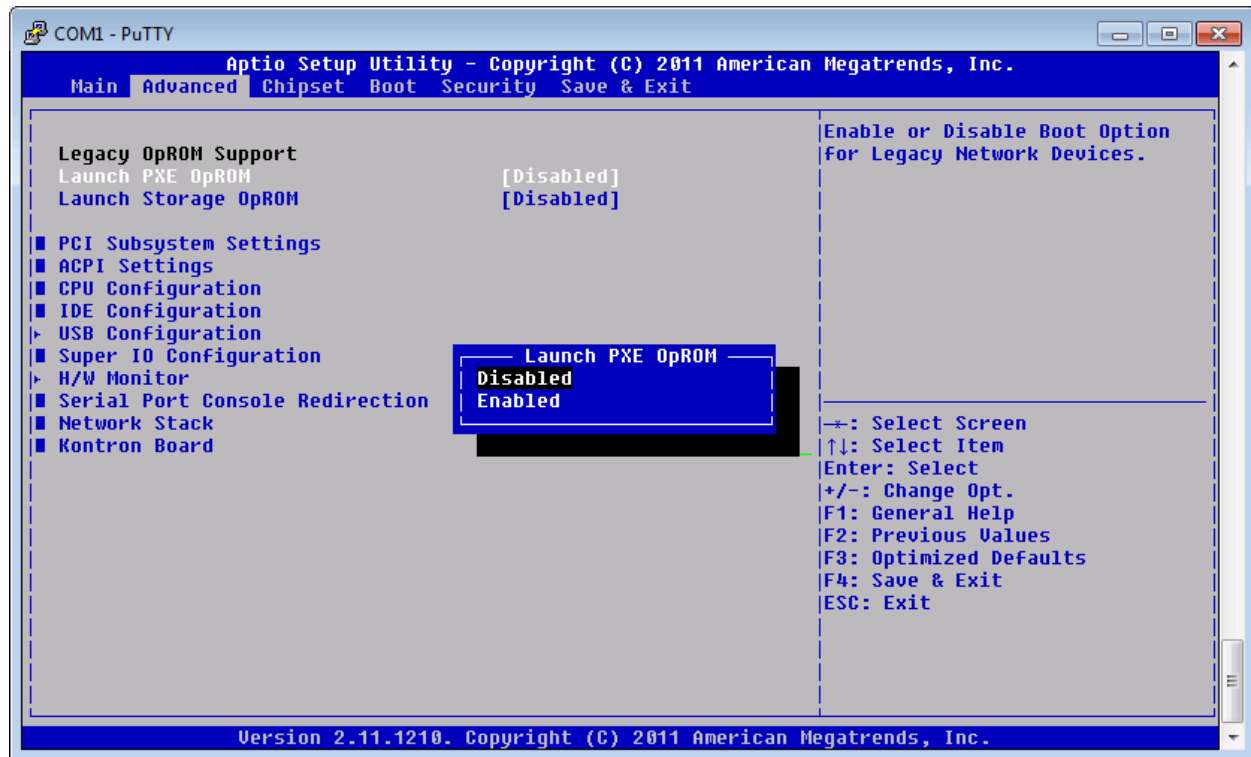

Launch Storage OpROM

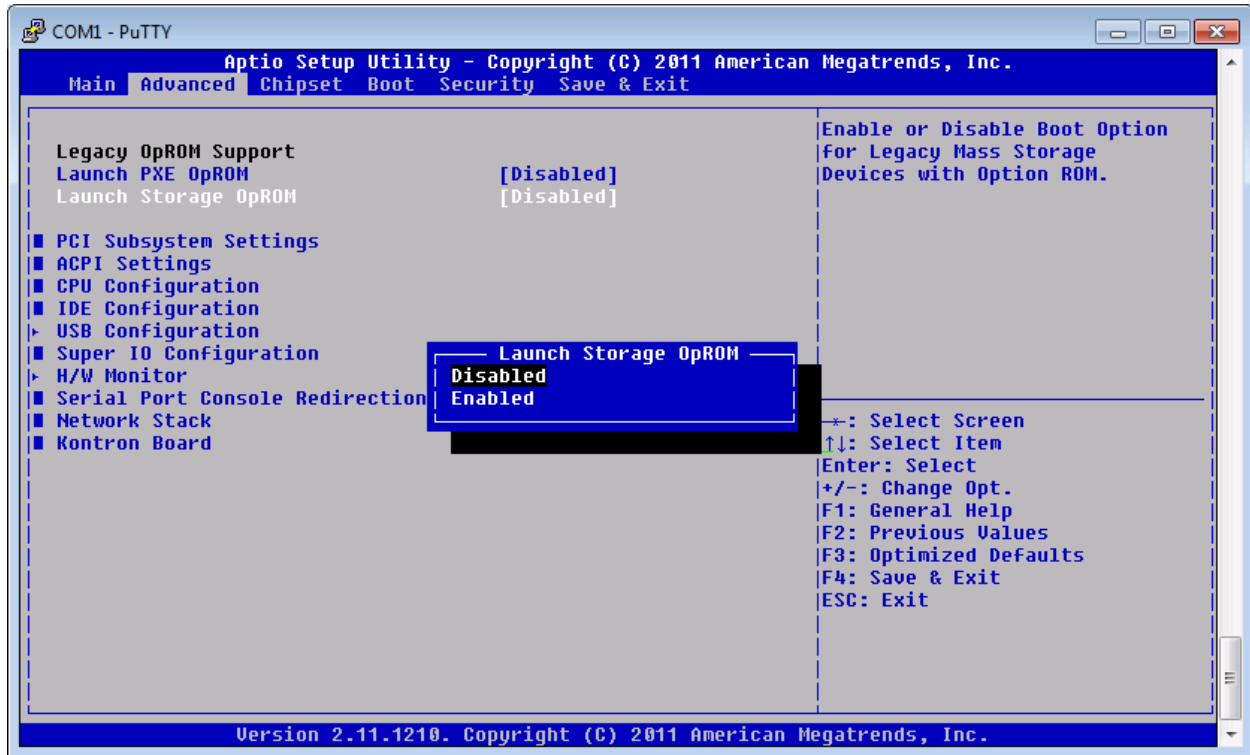

PCI Subsystem Settings

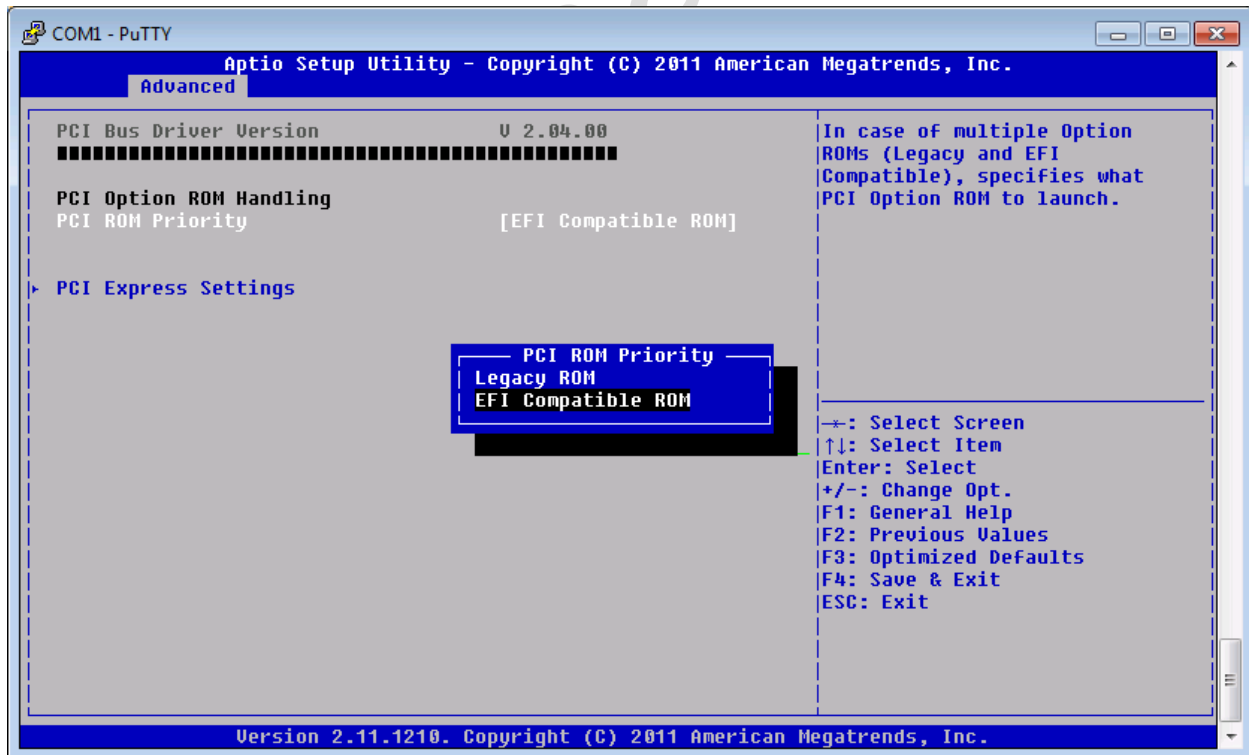
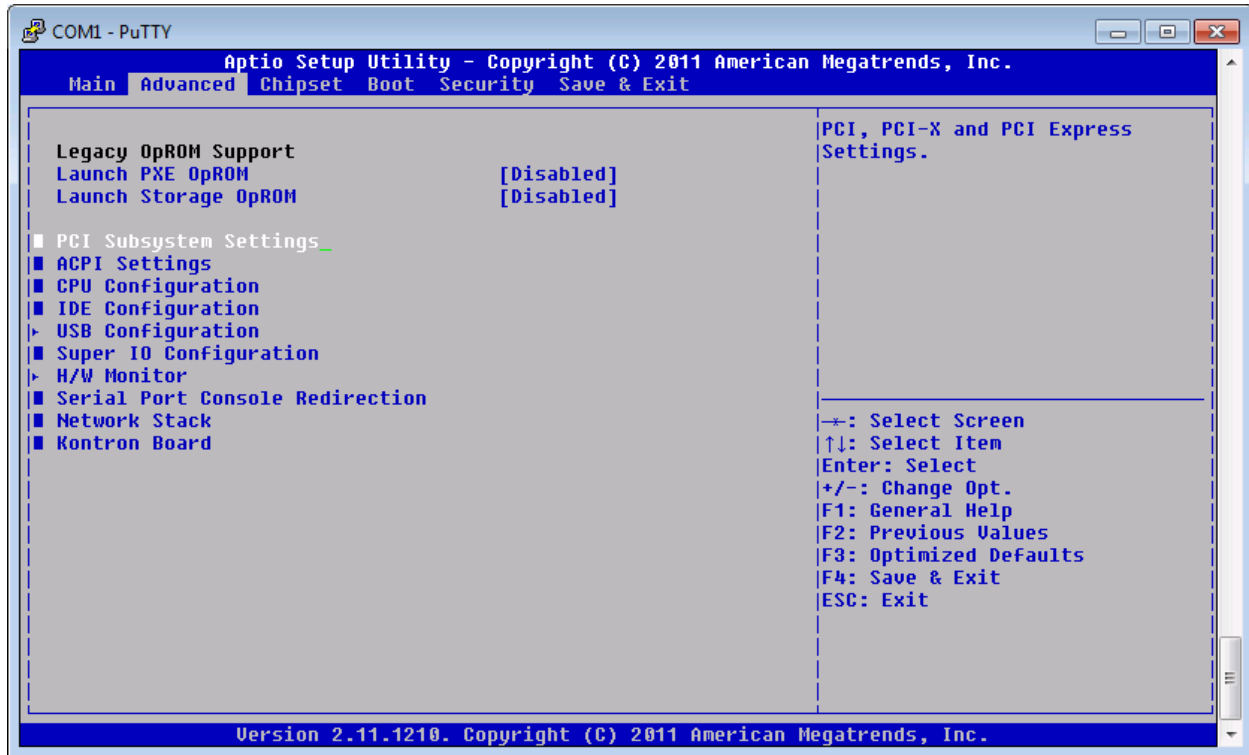

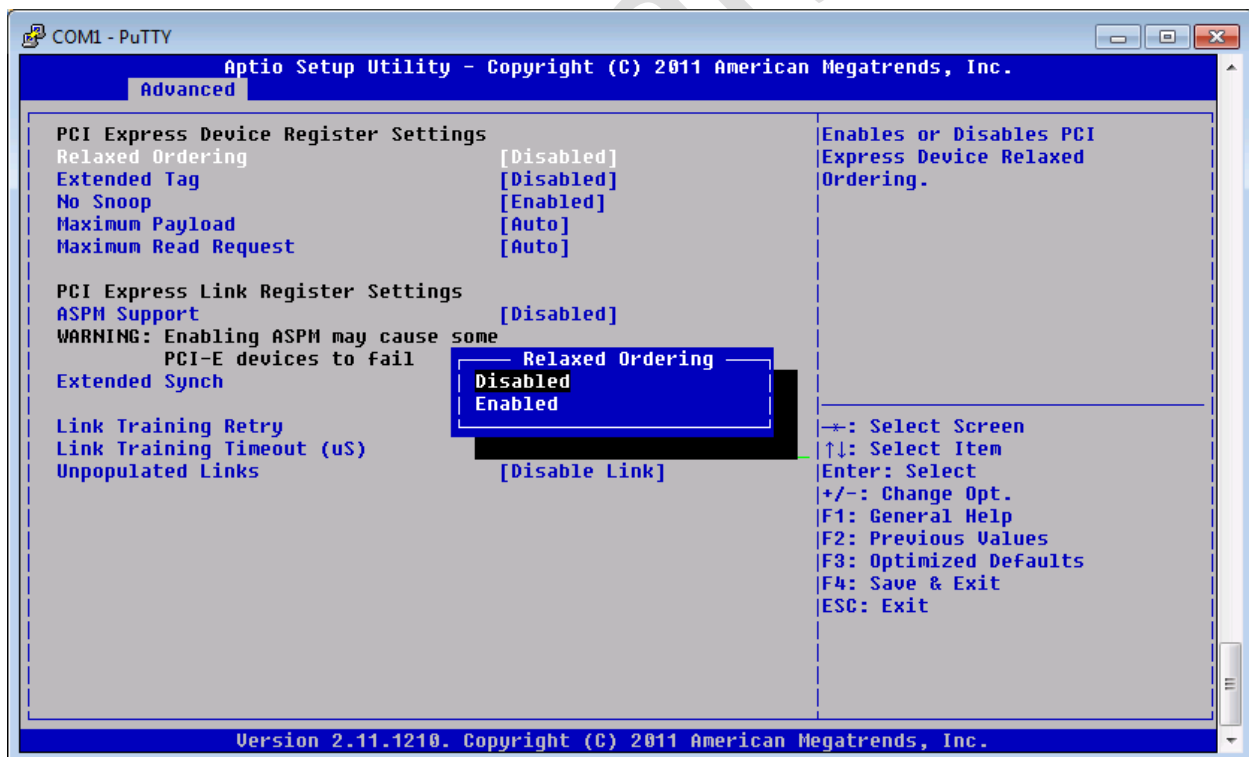
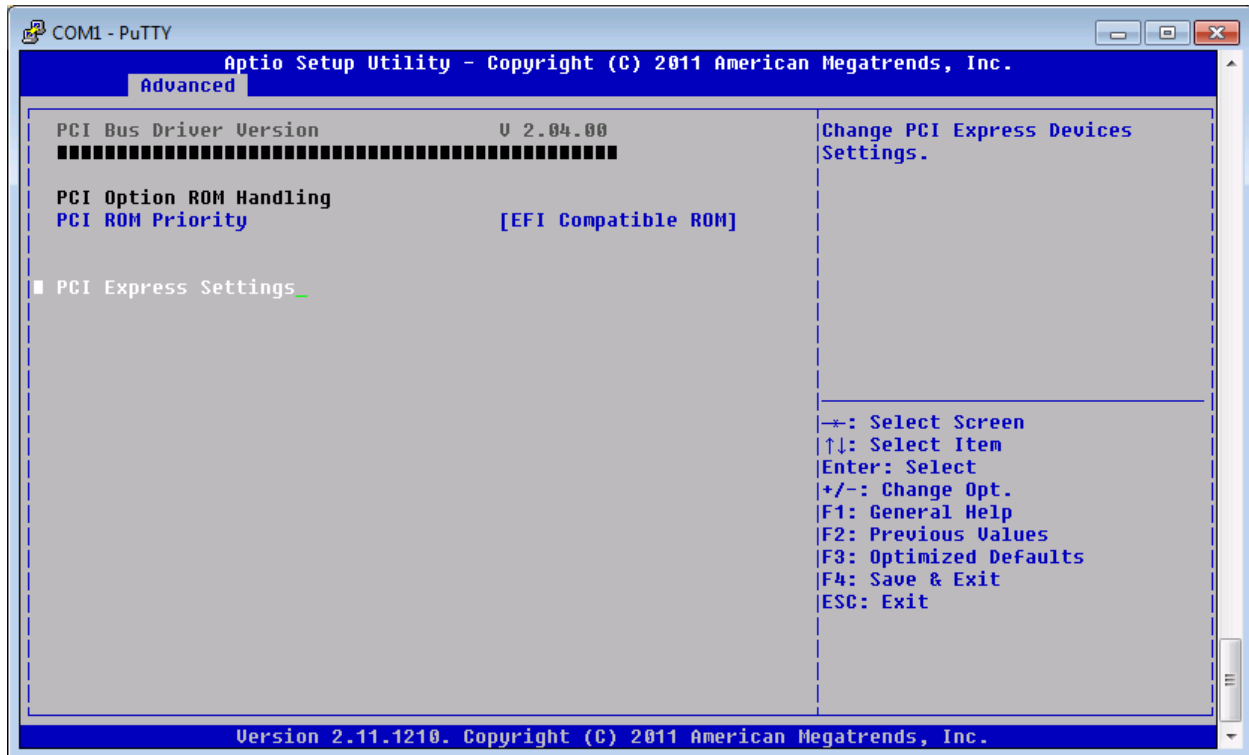

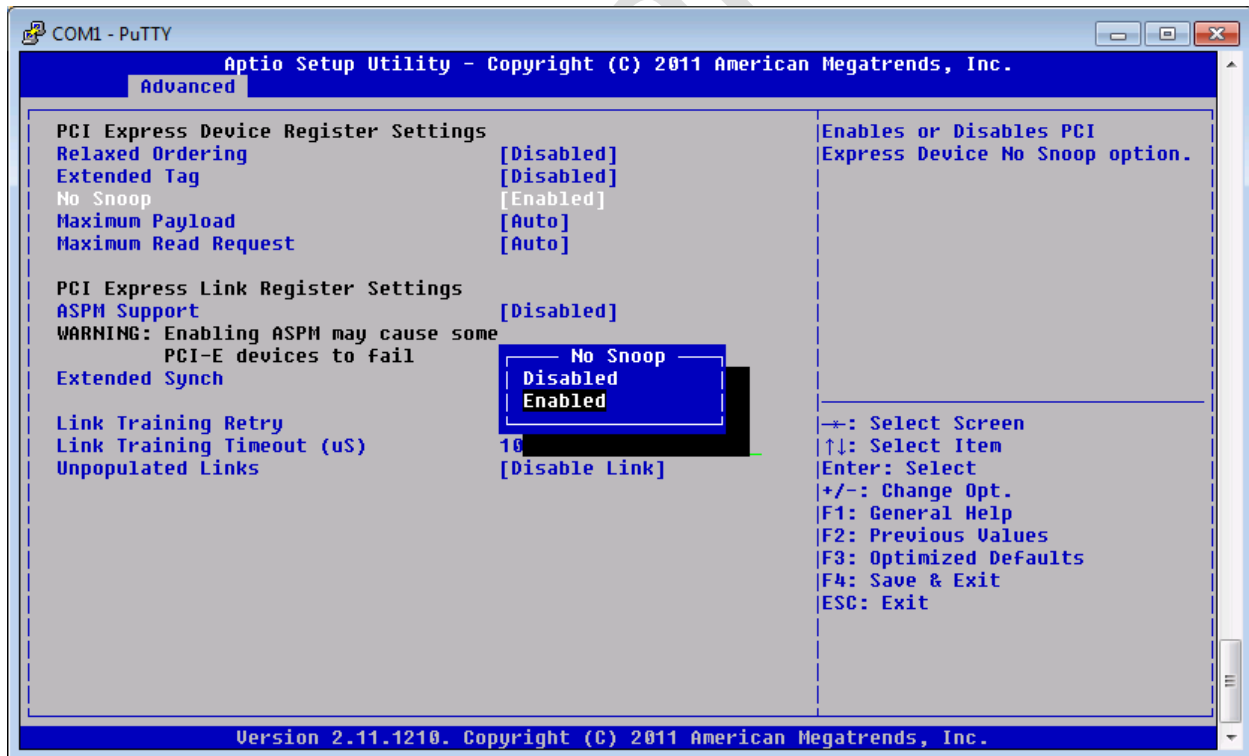
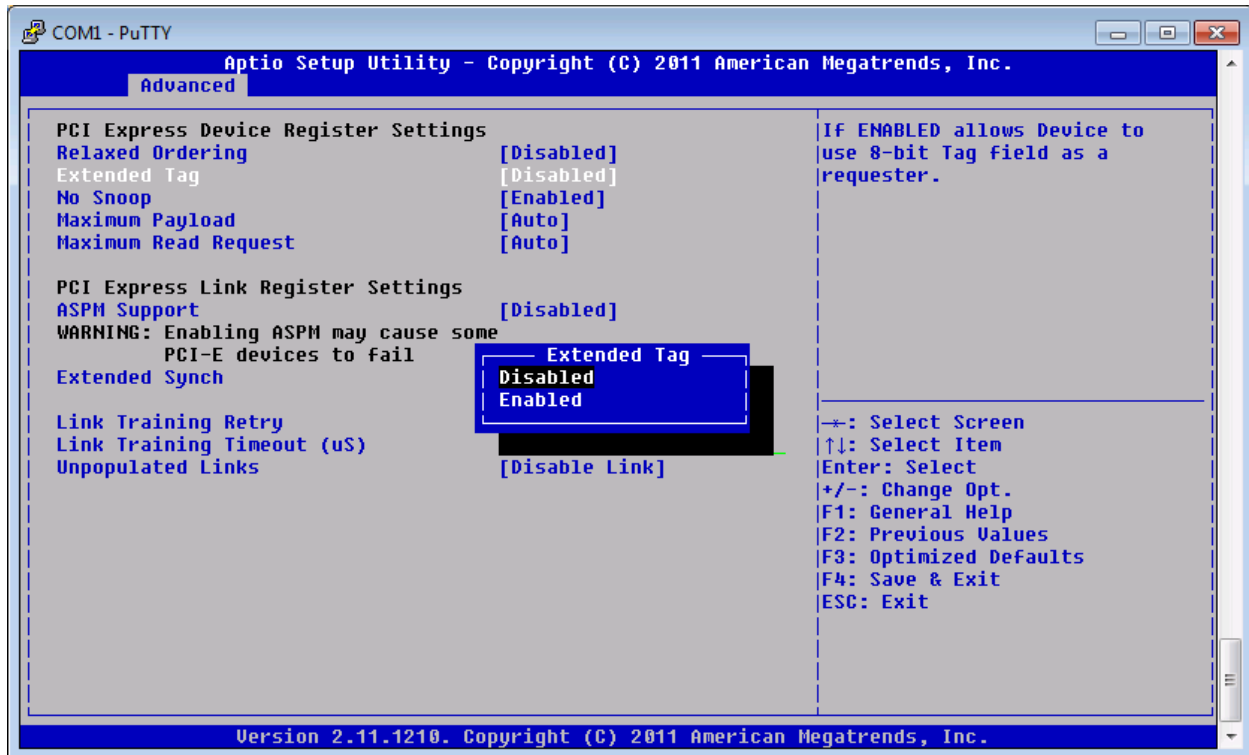

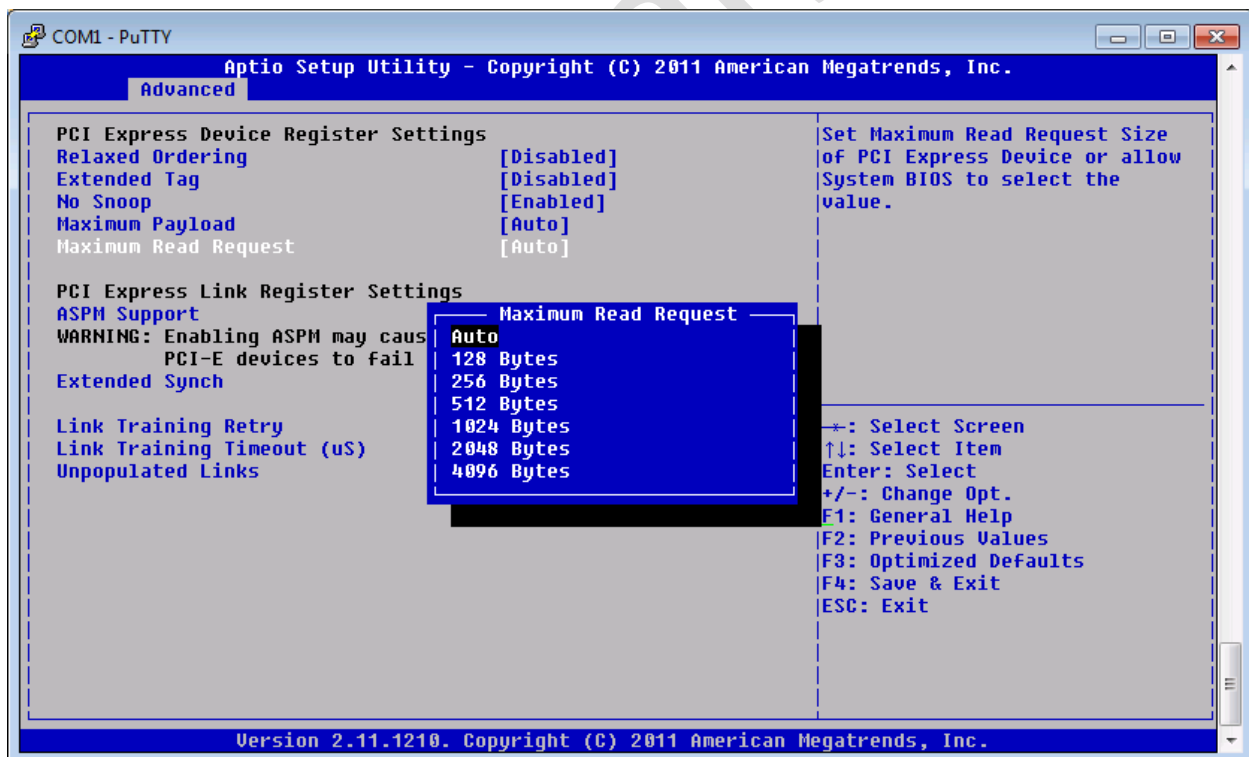
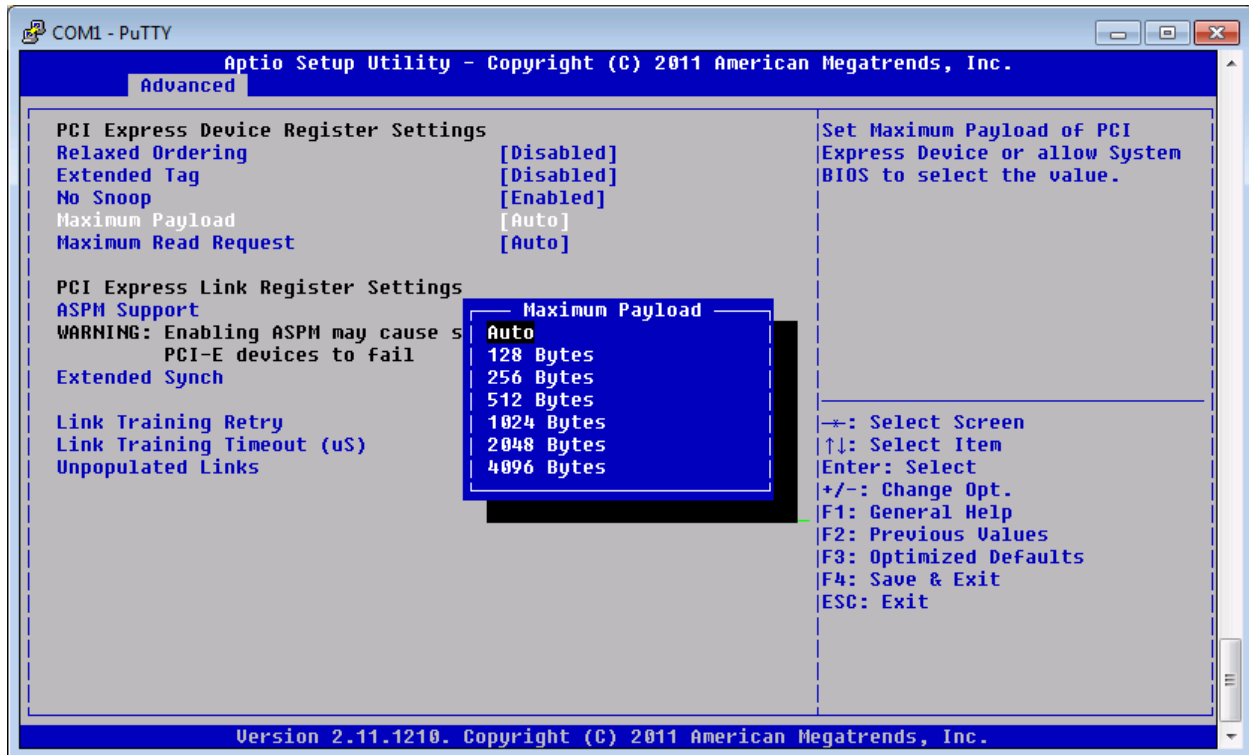

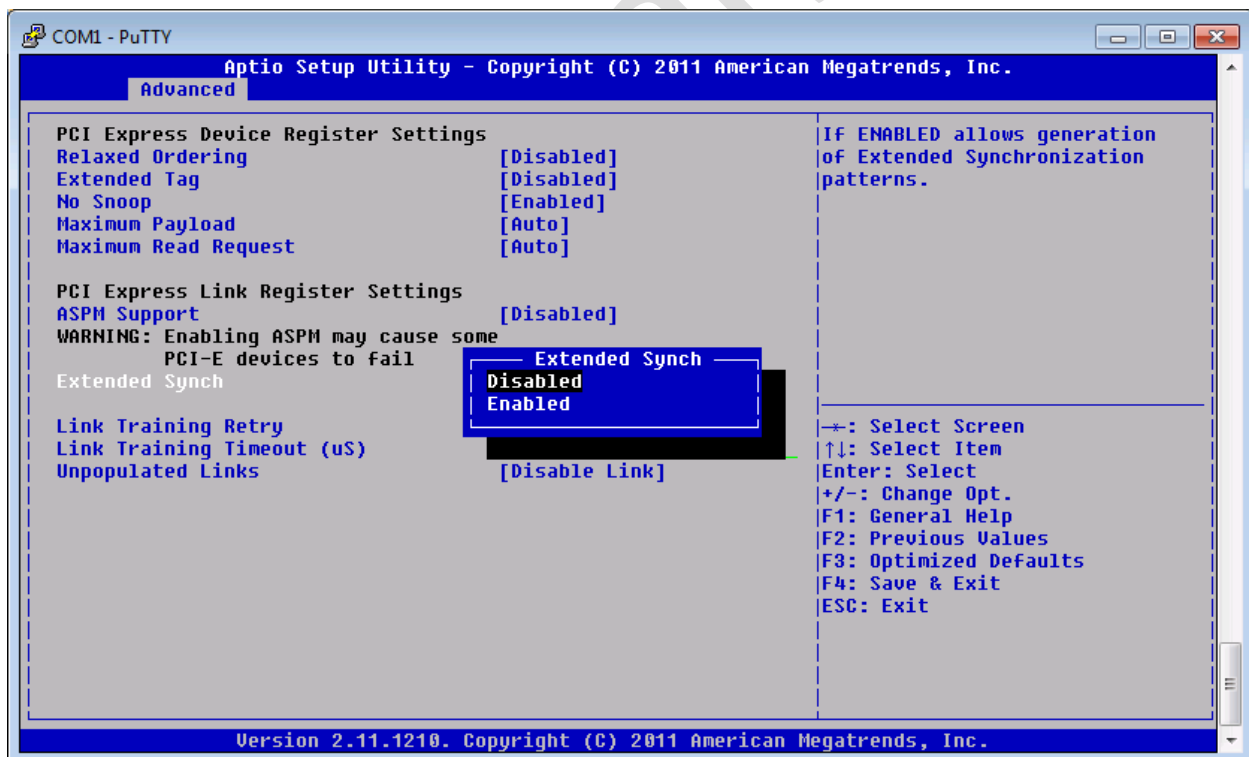
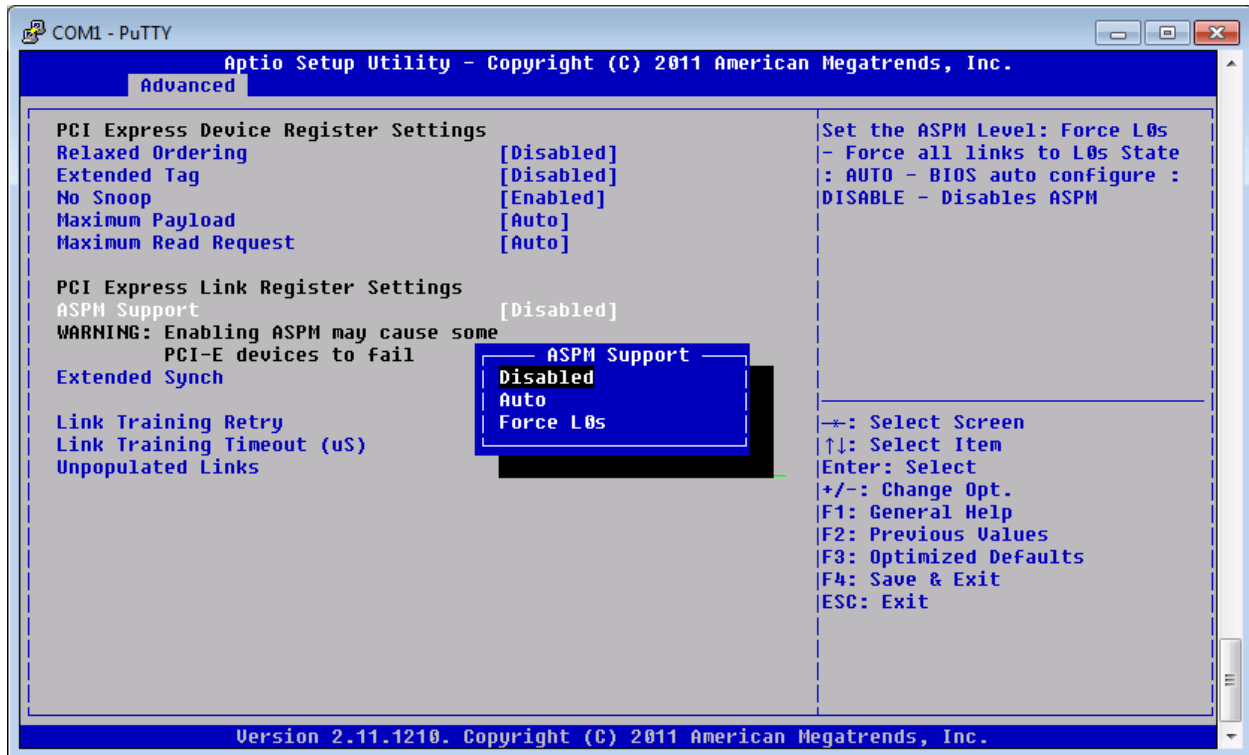

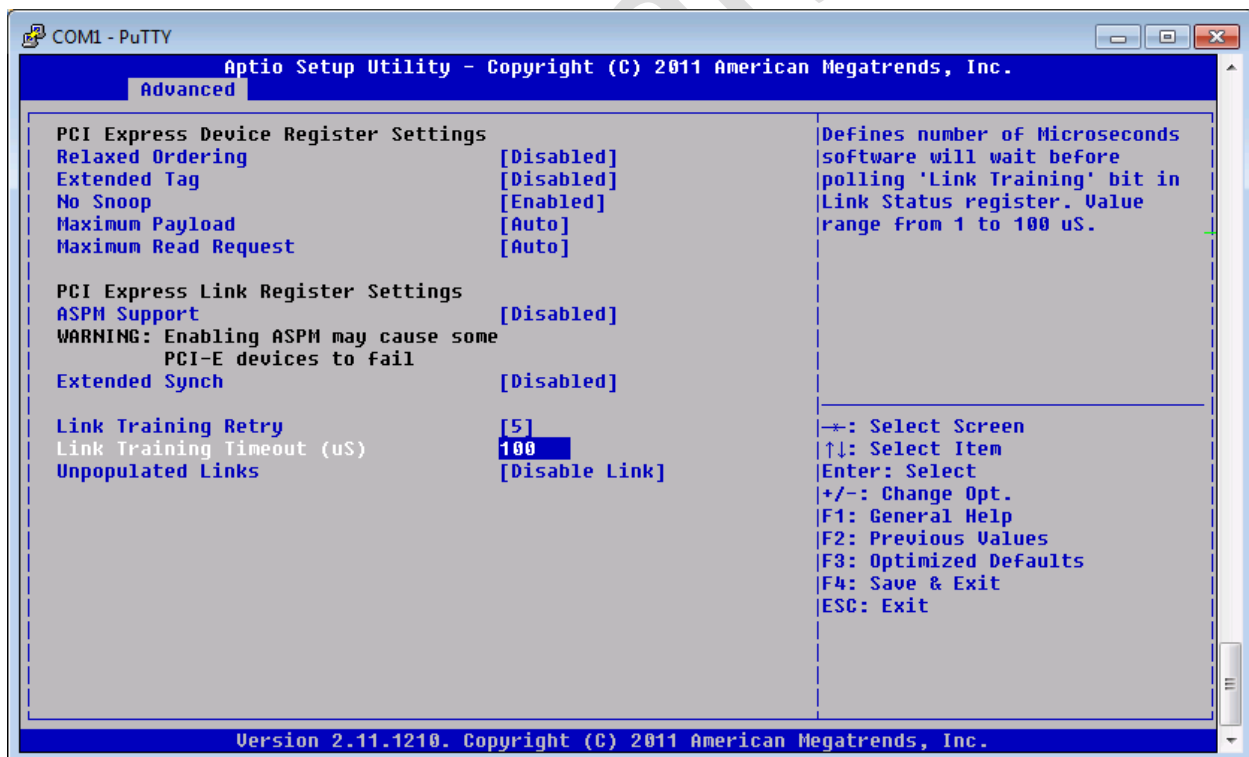
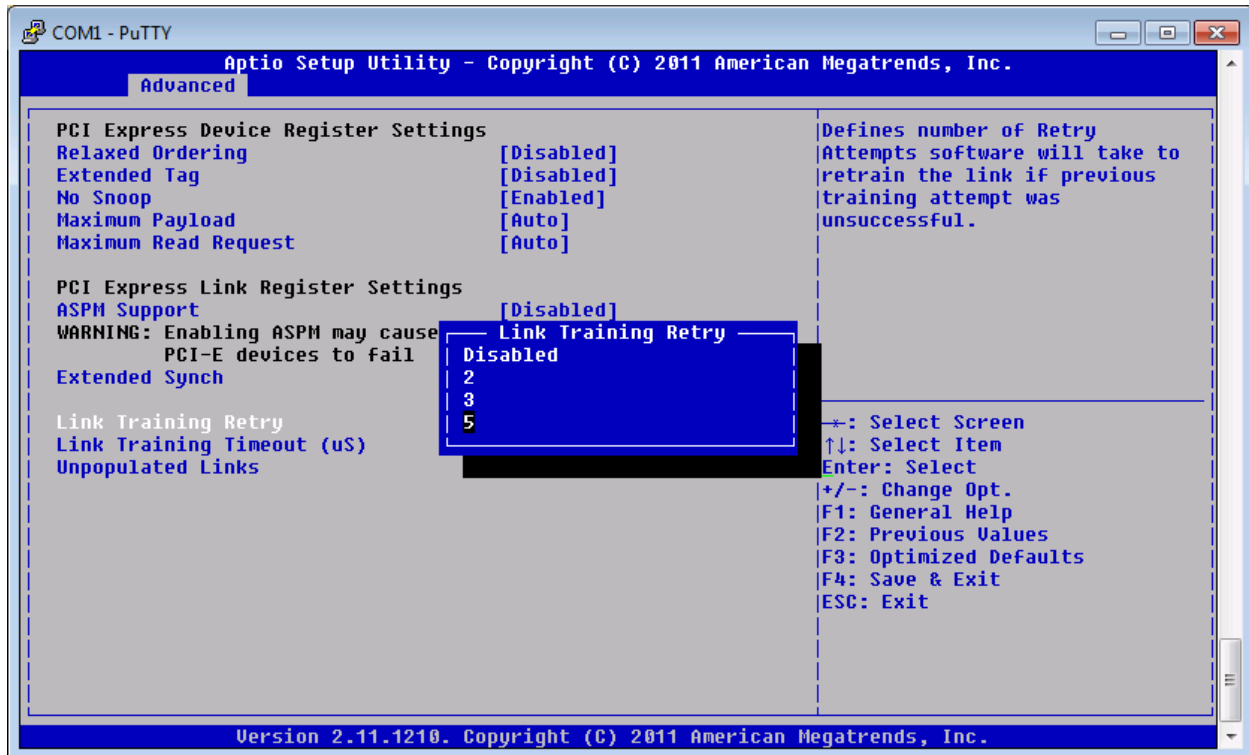

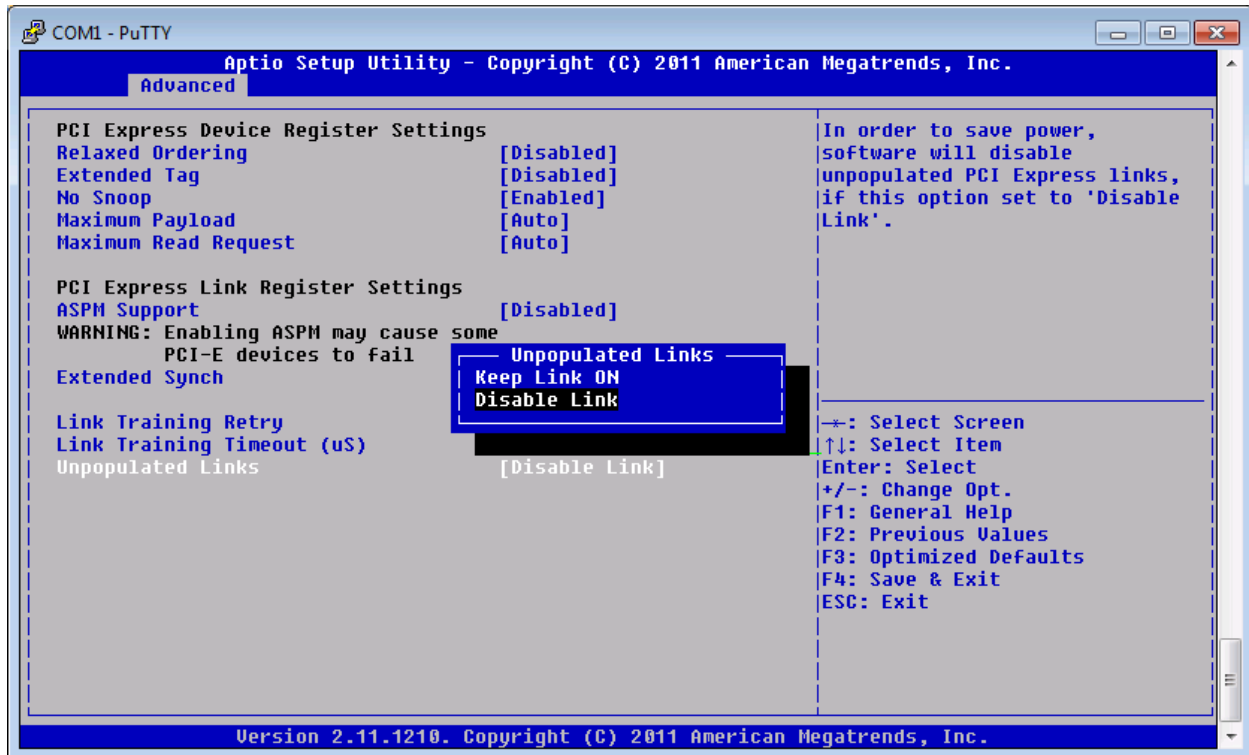

ACPI Settings

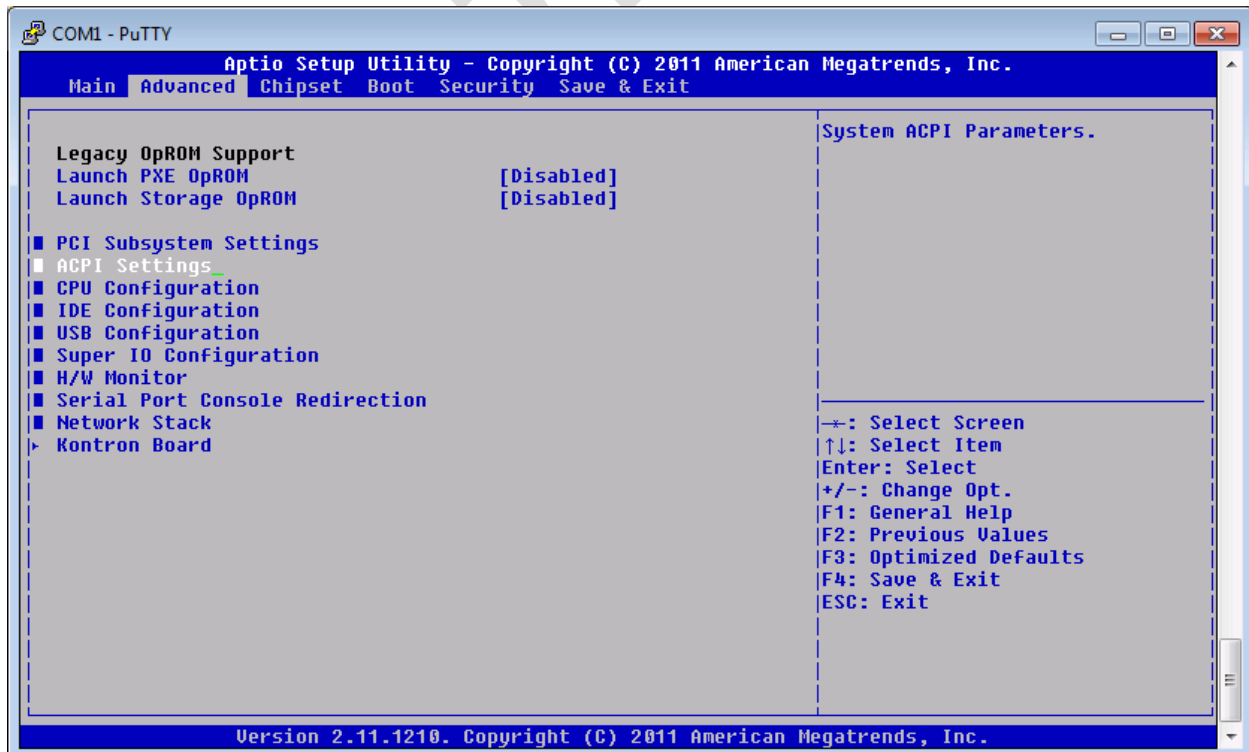

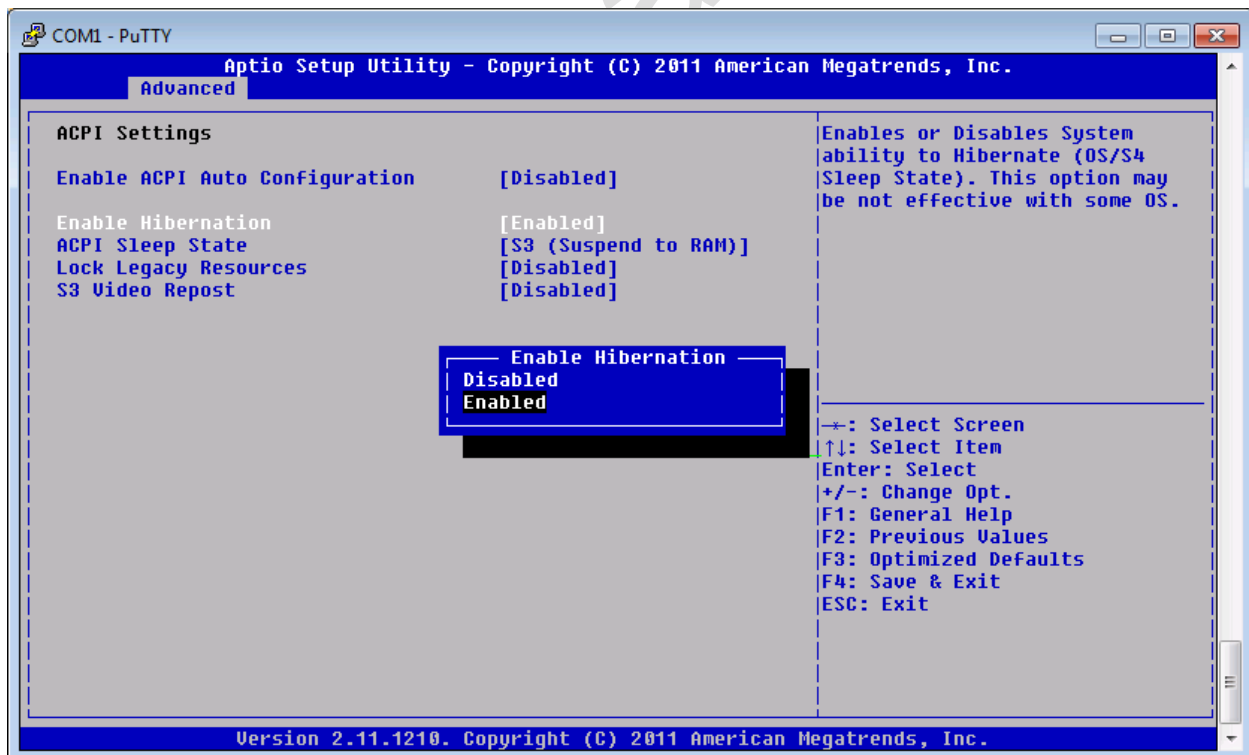
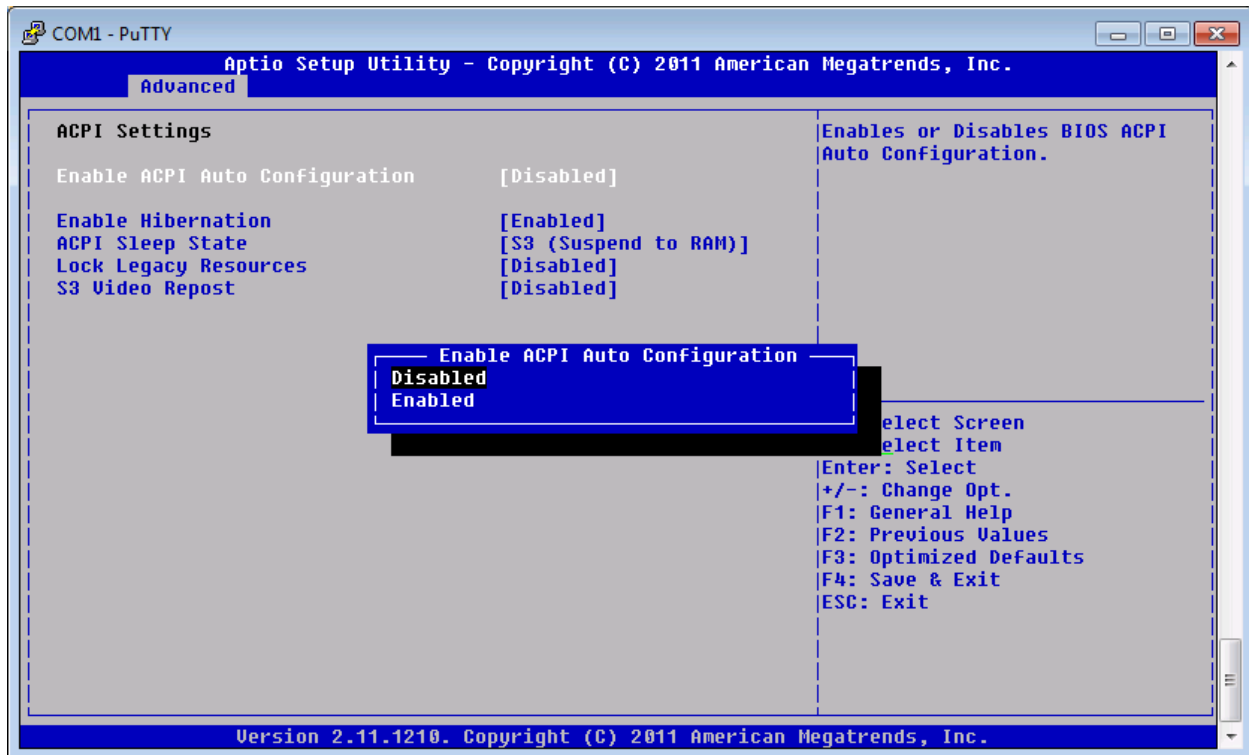

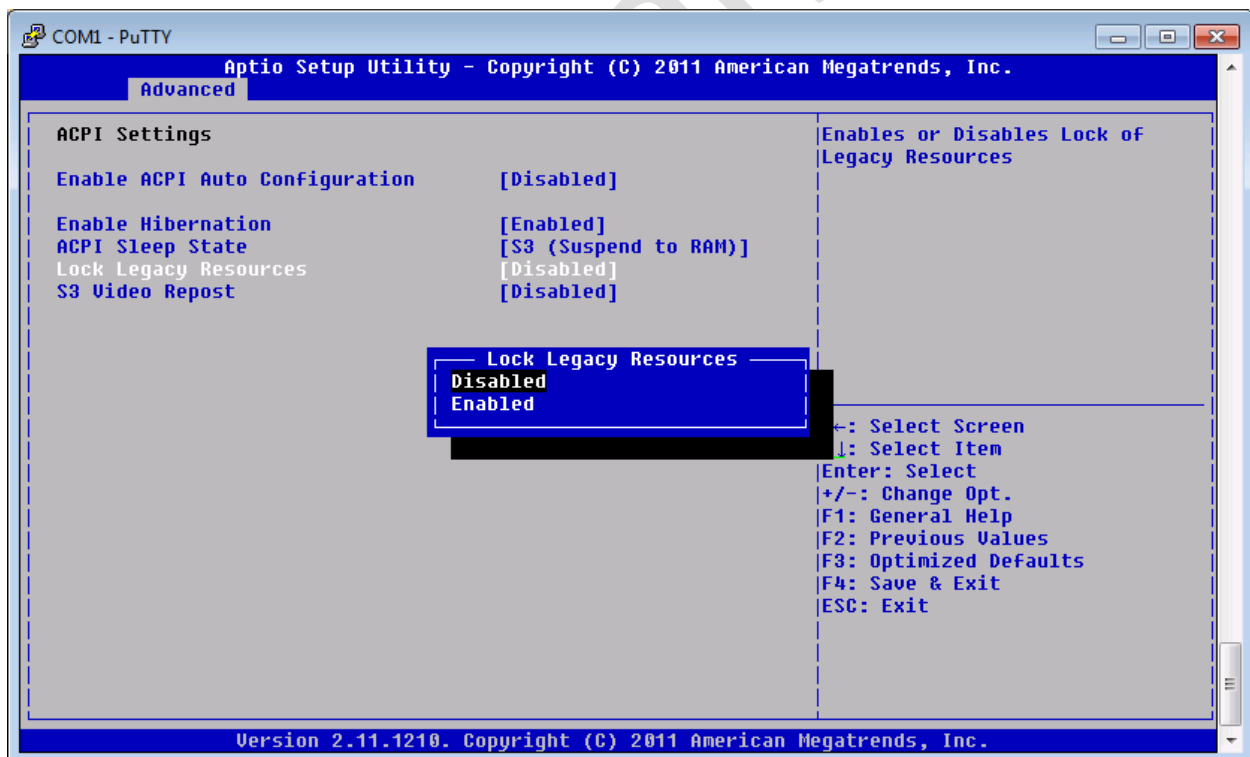
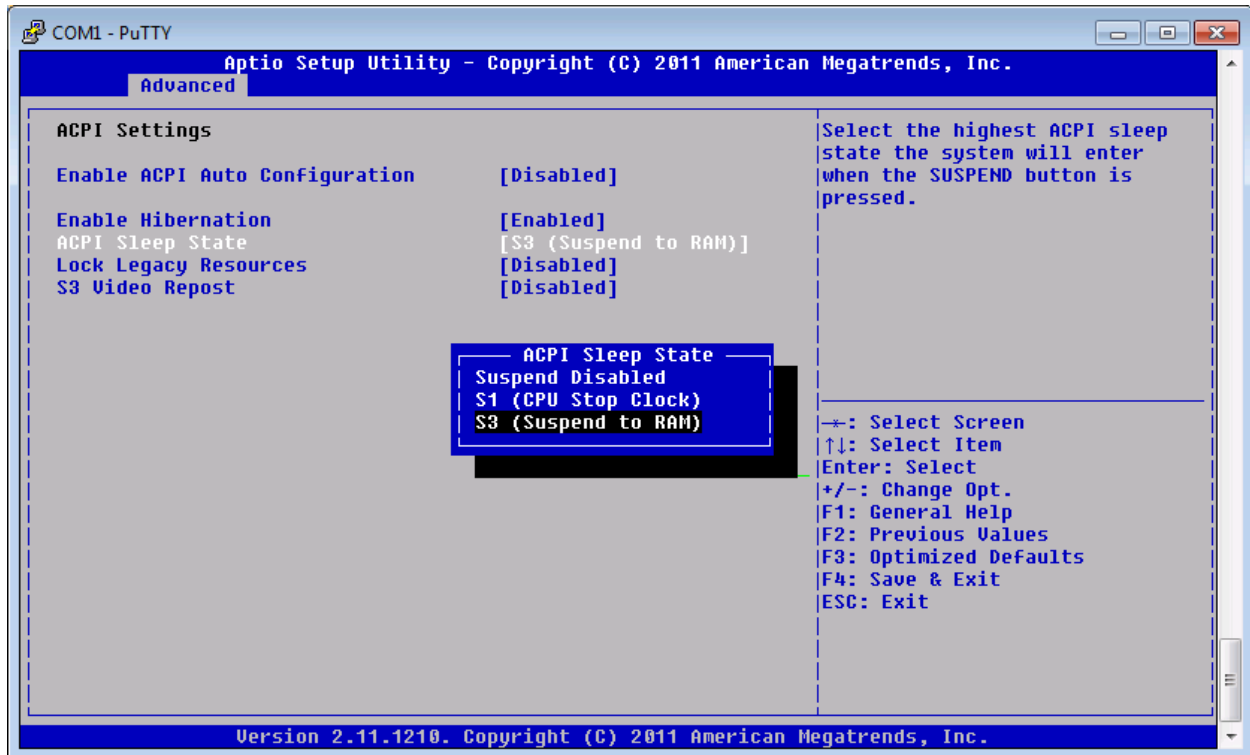

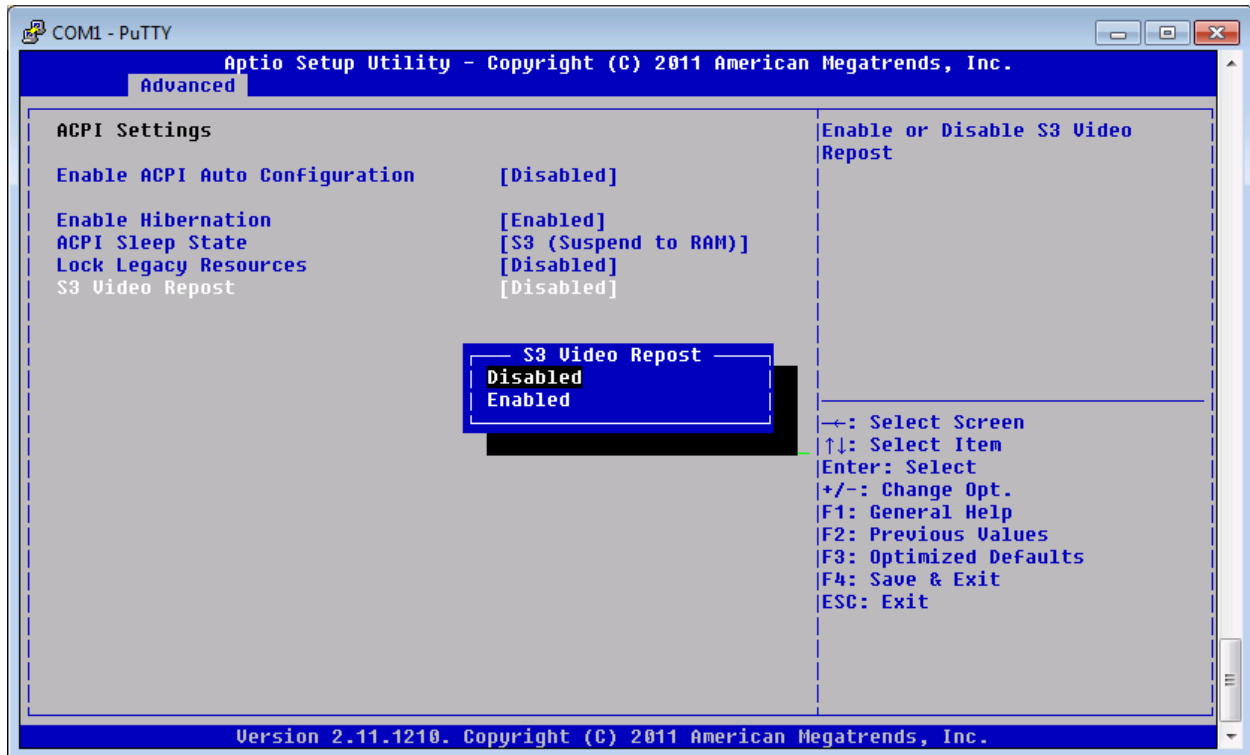

CPU Configuration

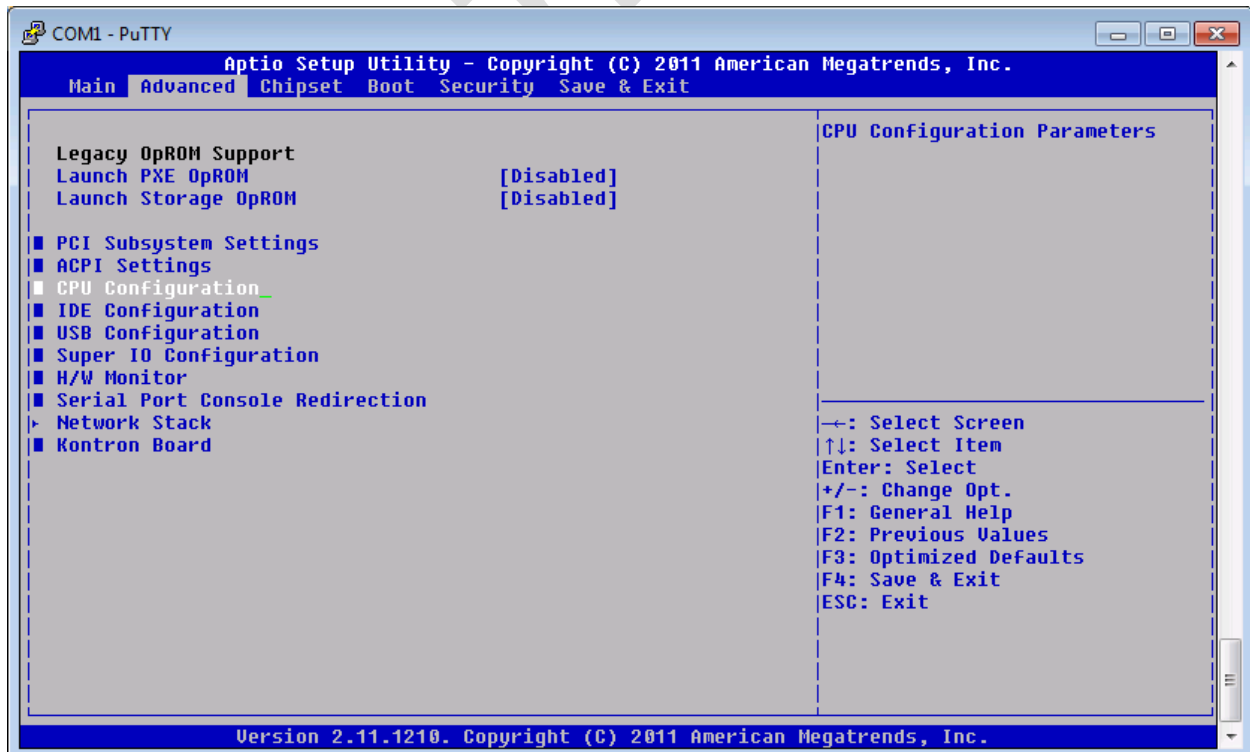

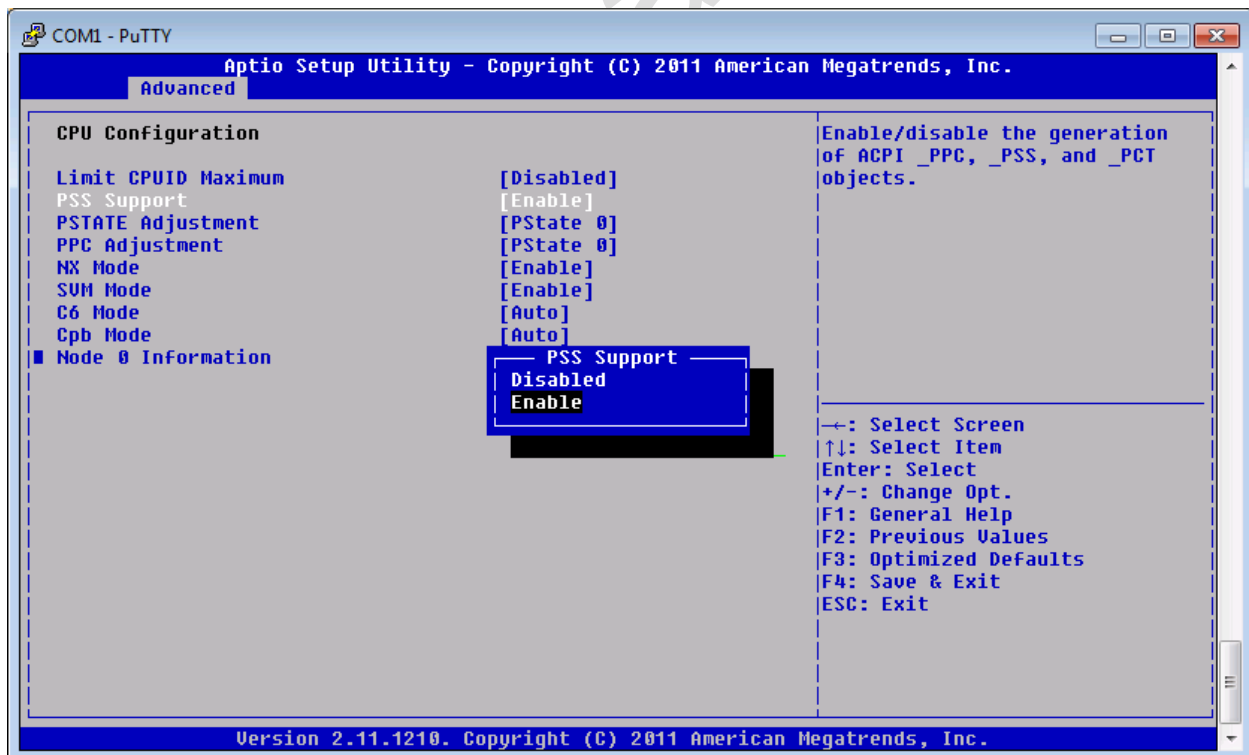
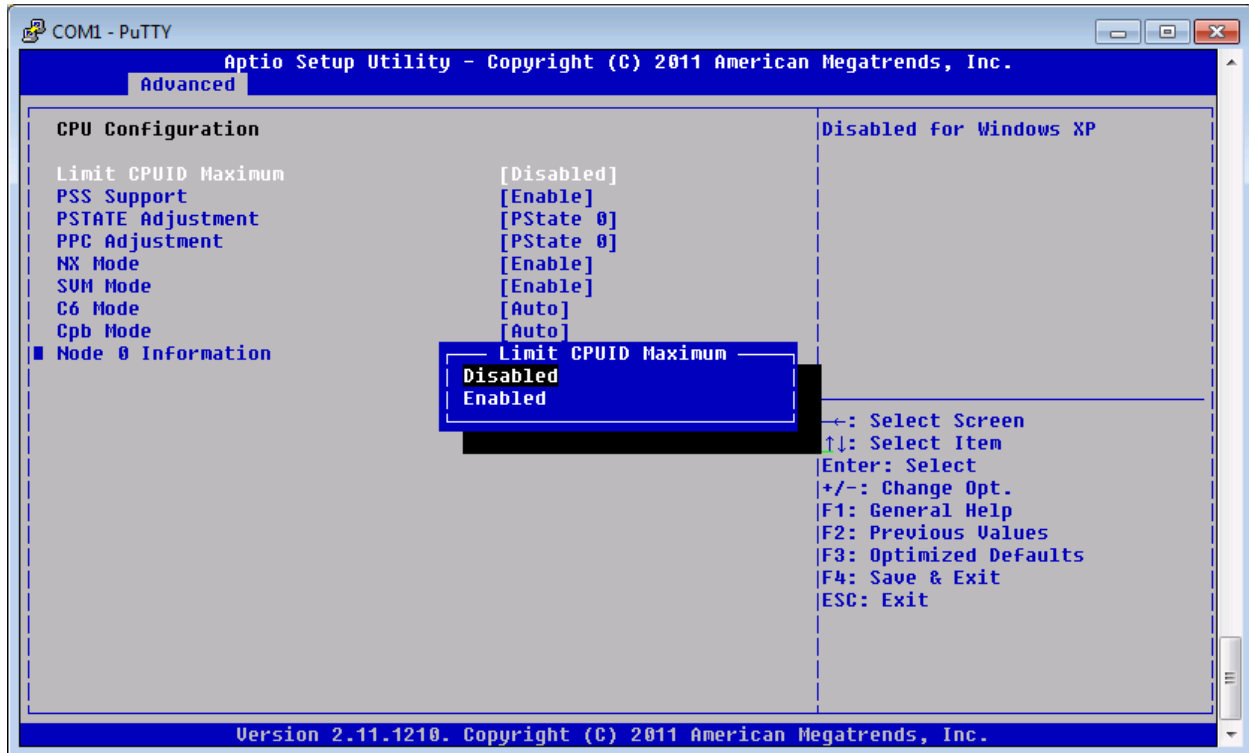

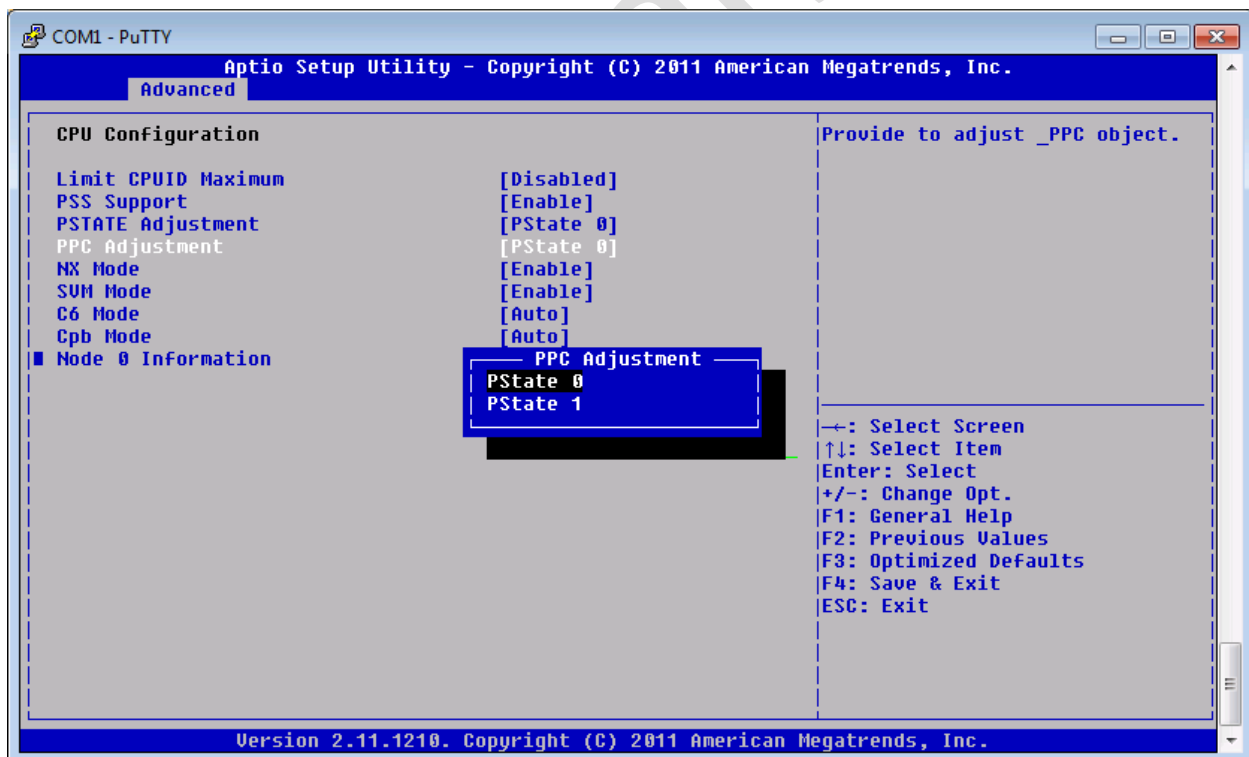
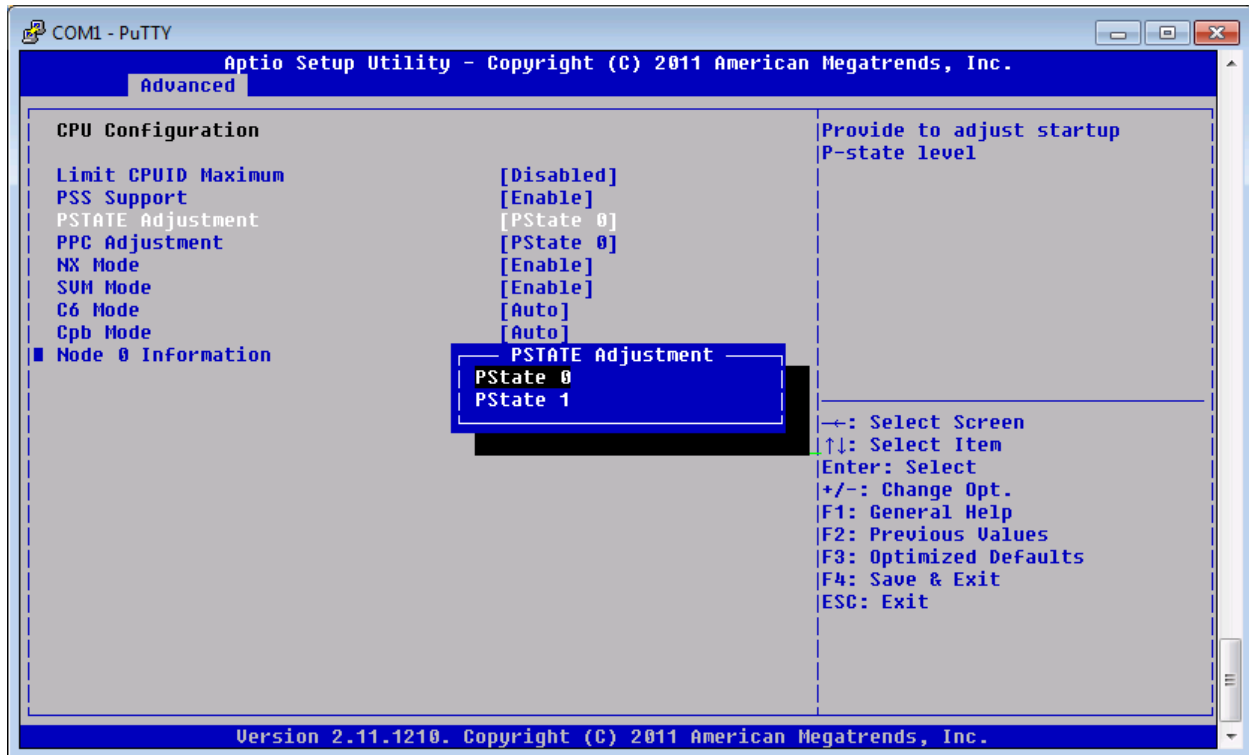

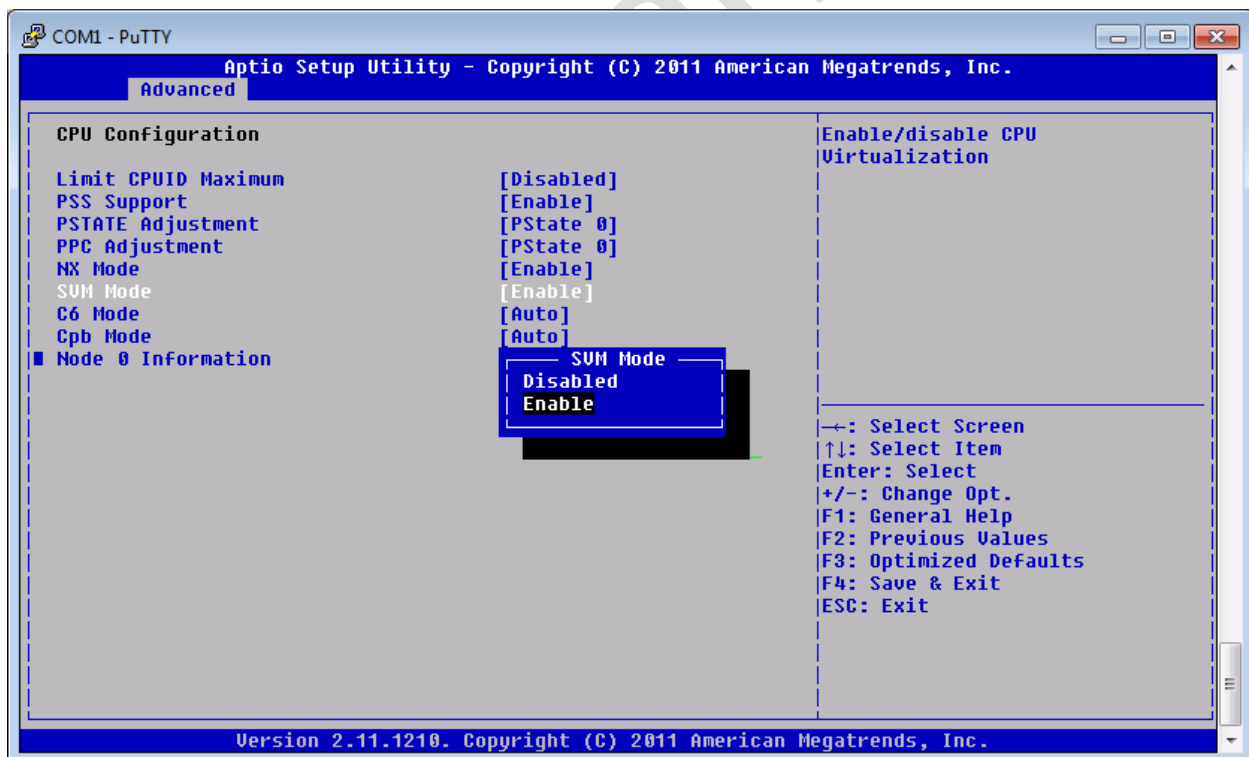
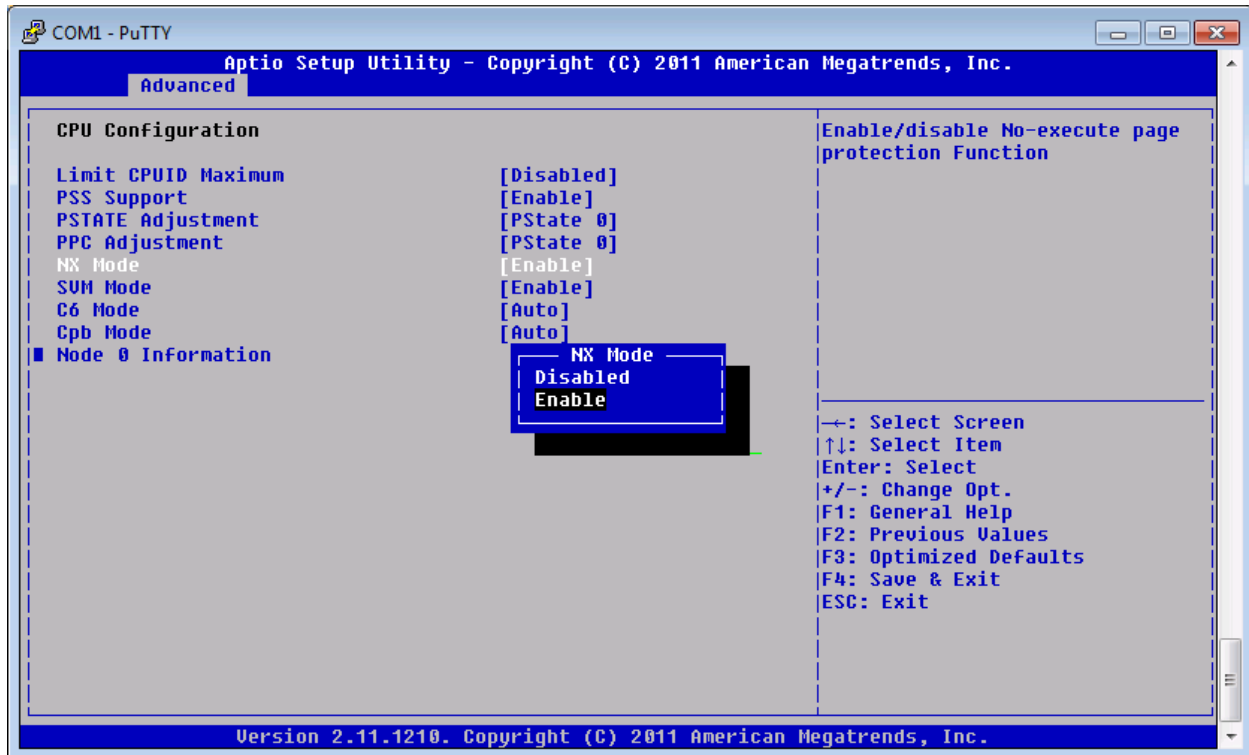

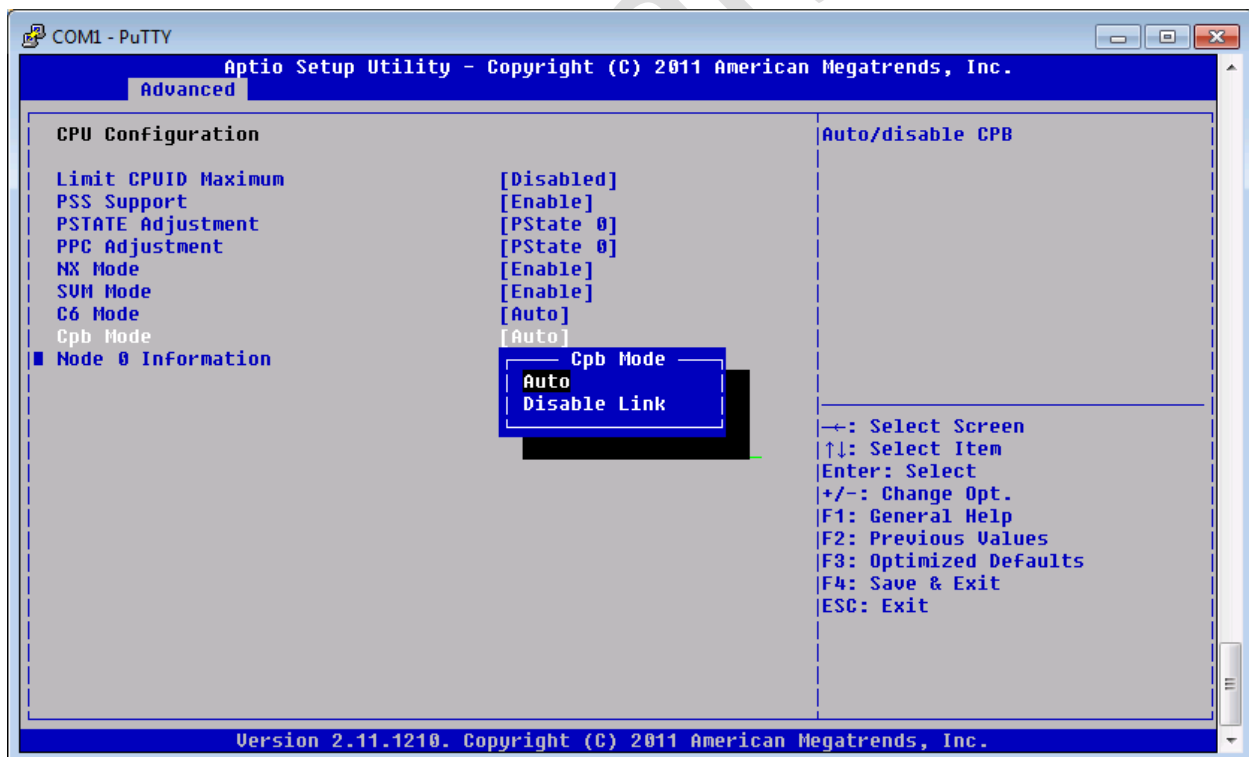
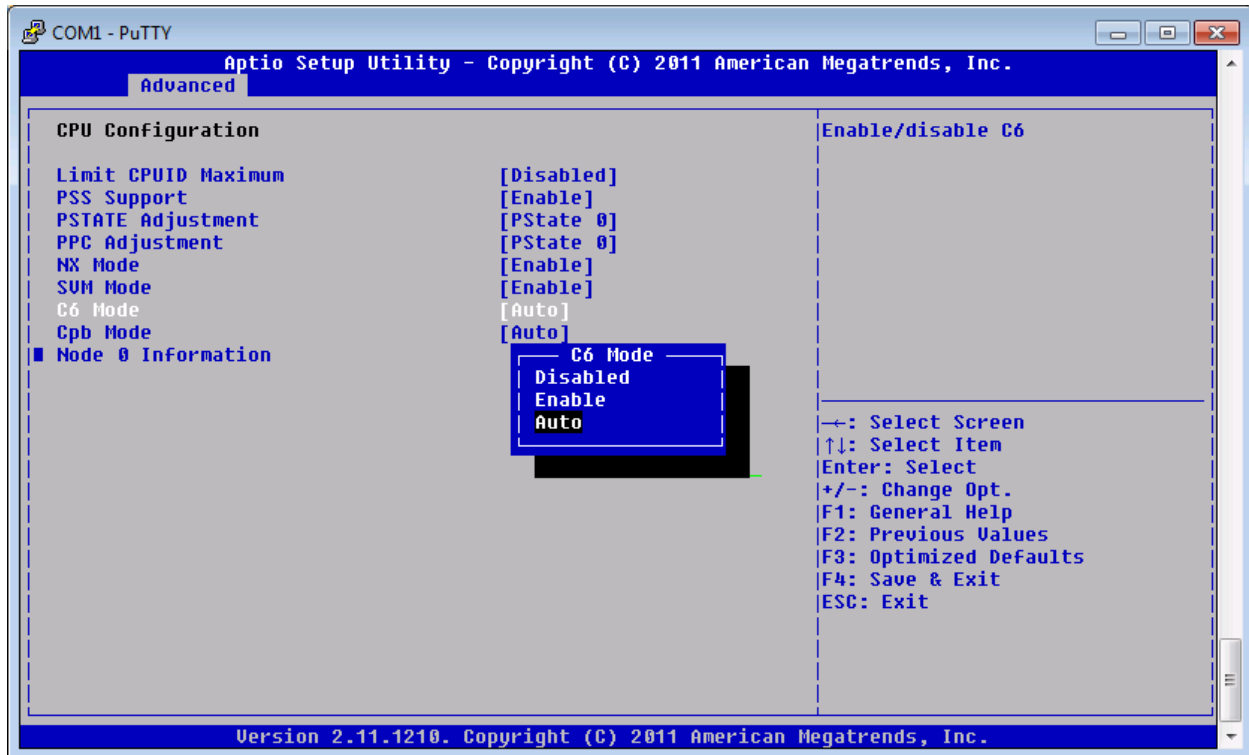

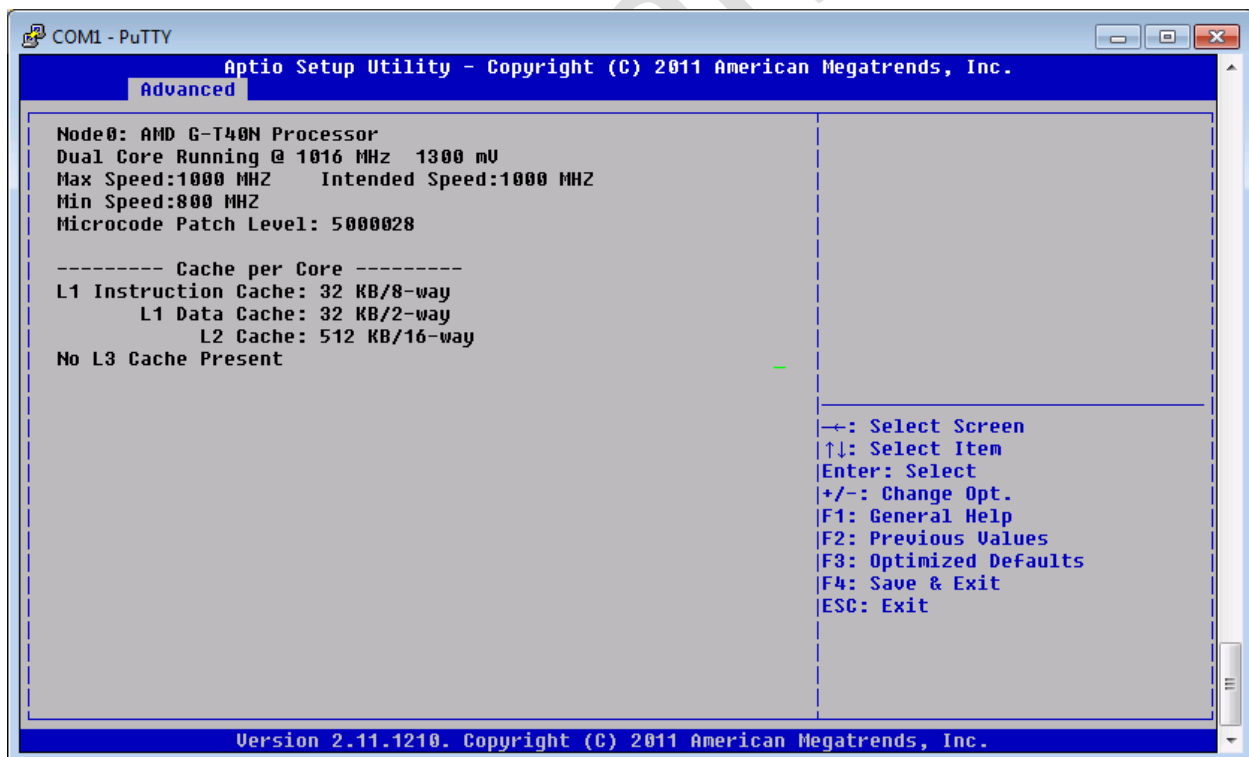
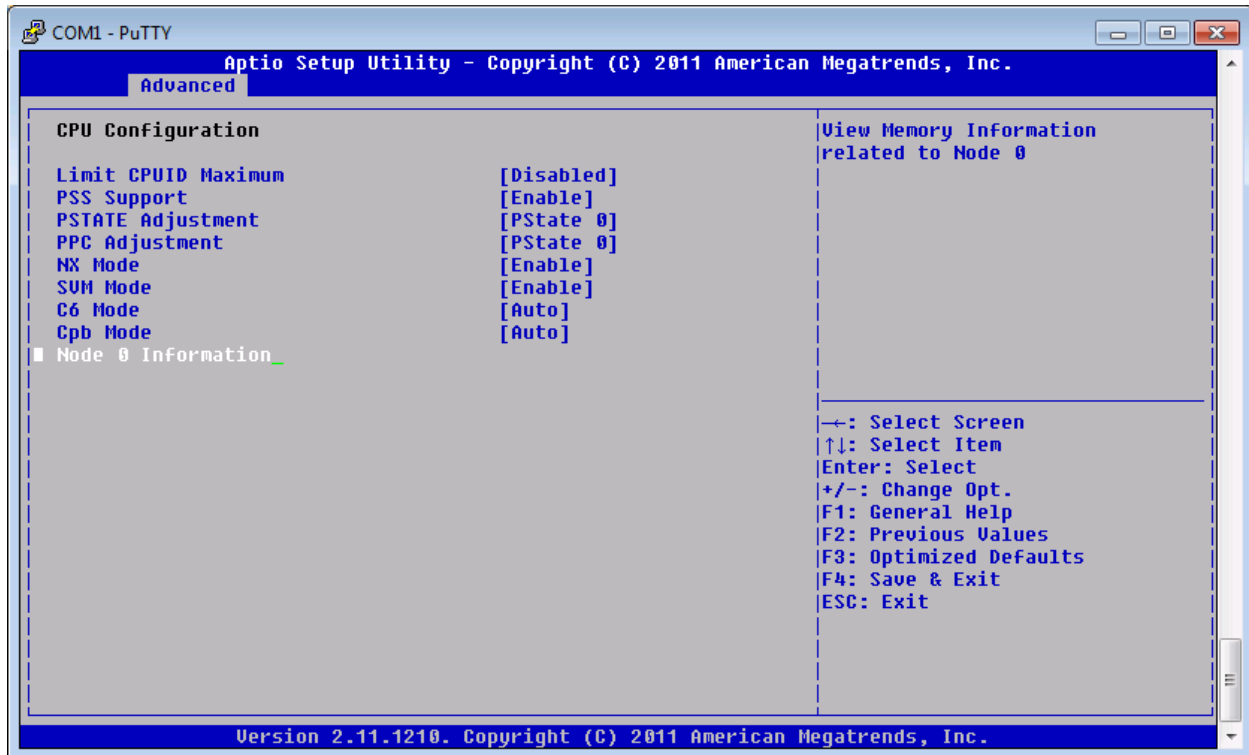

IDE Configuration

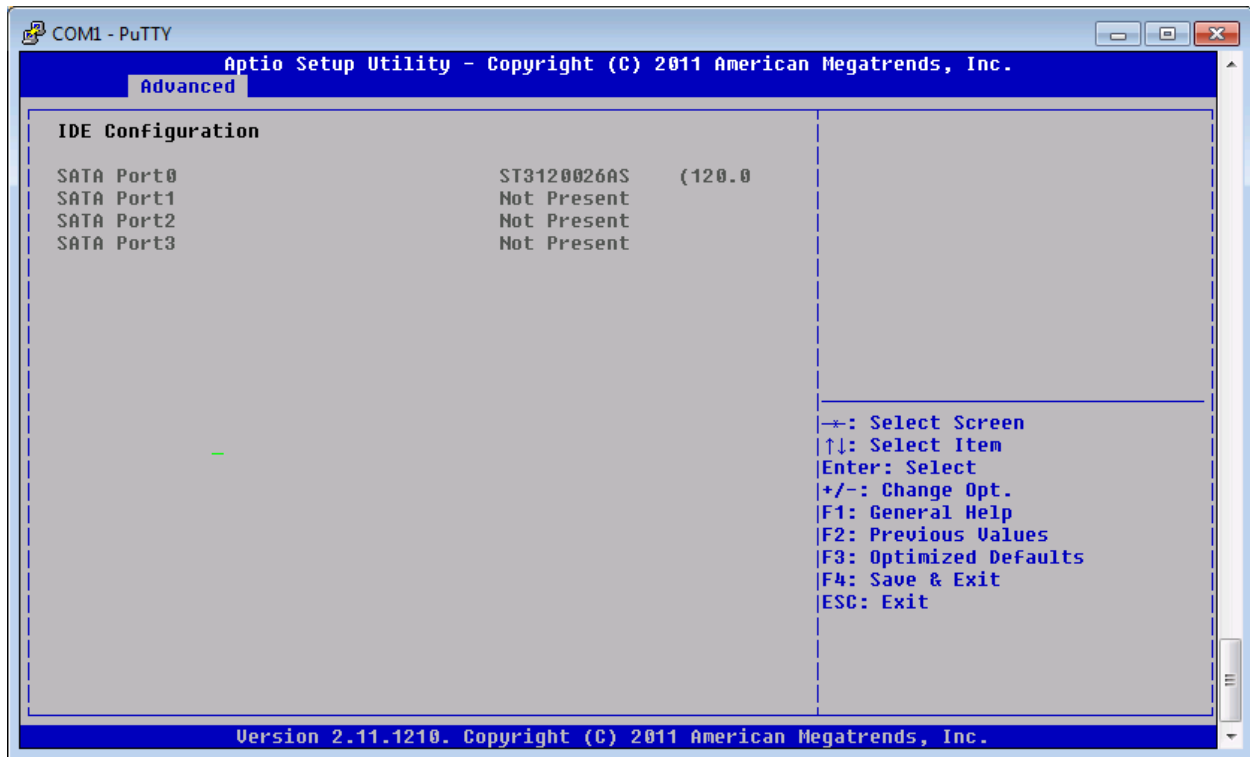

USB Configuration

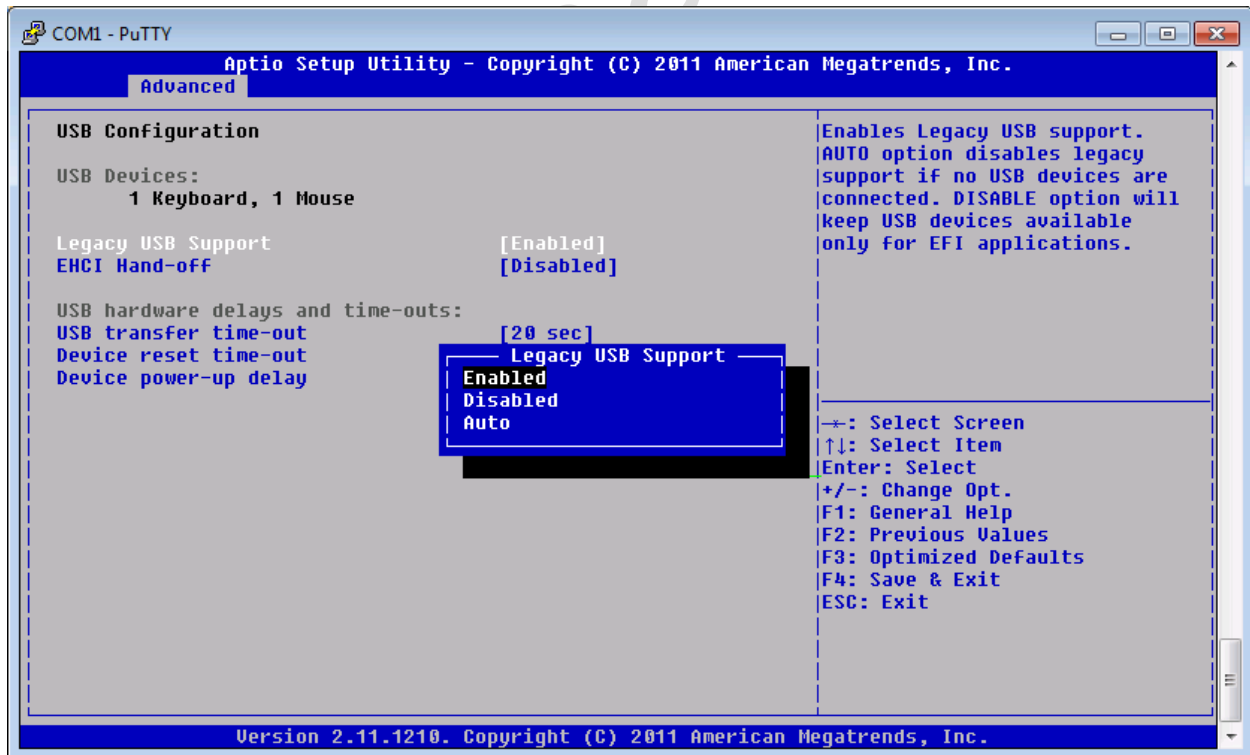
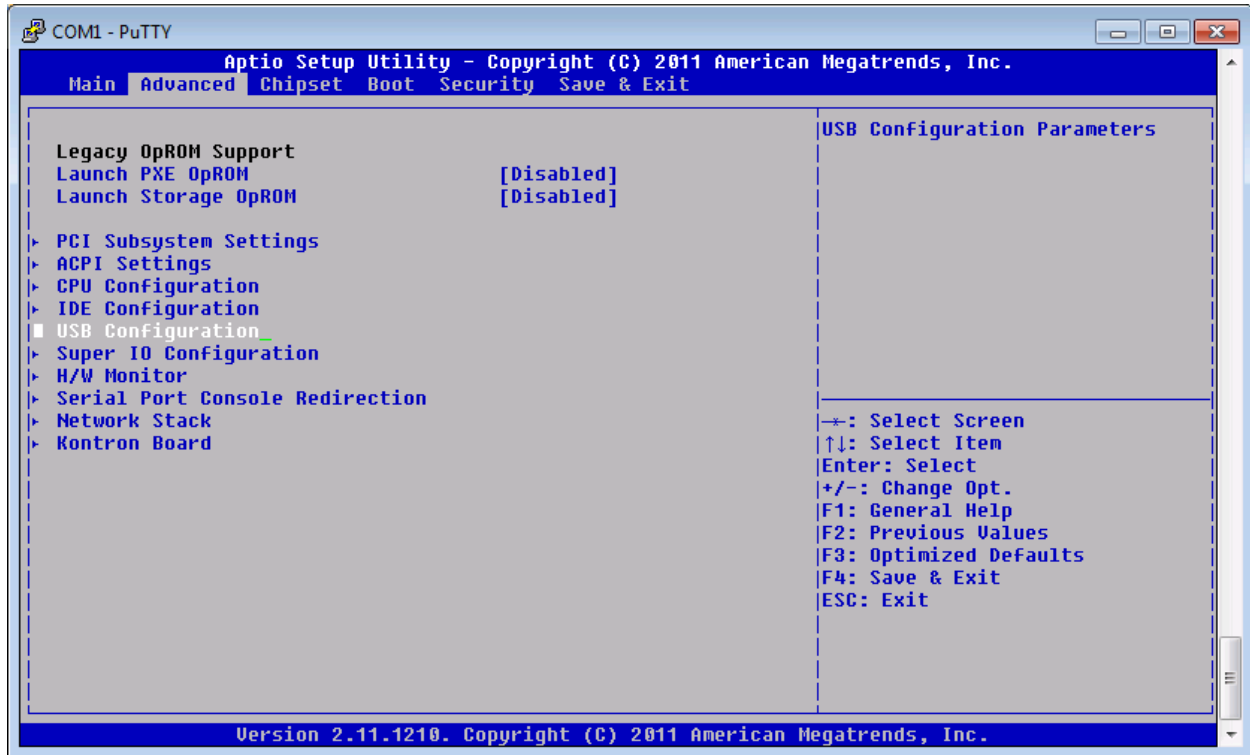

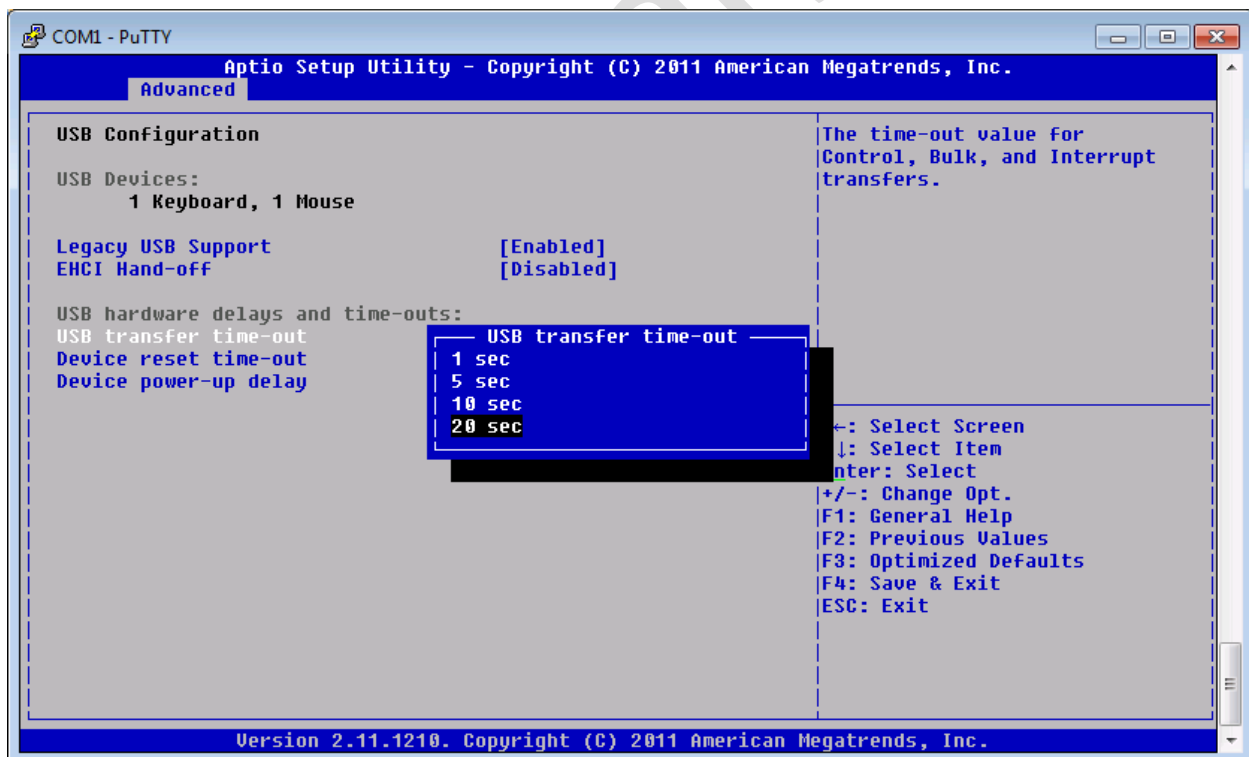
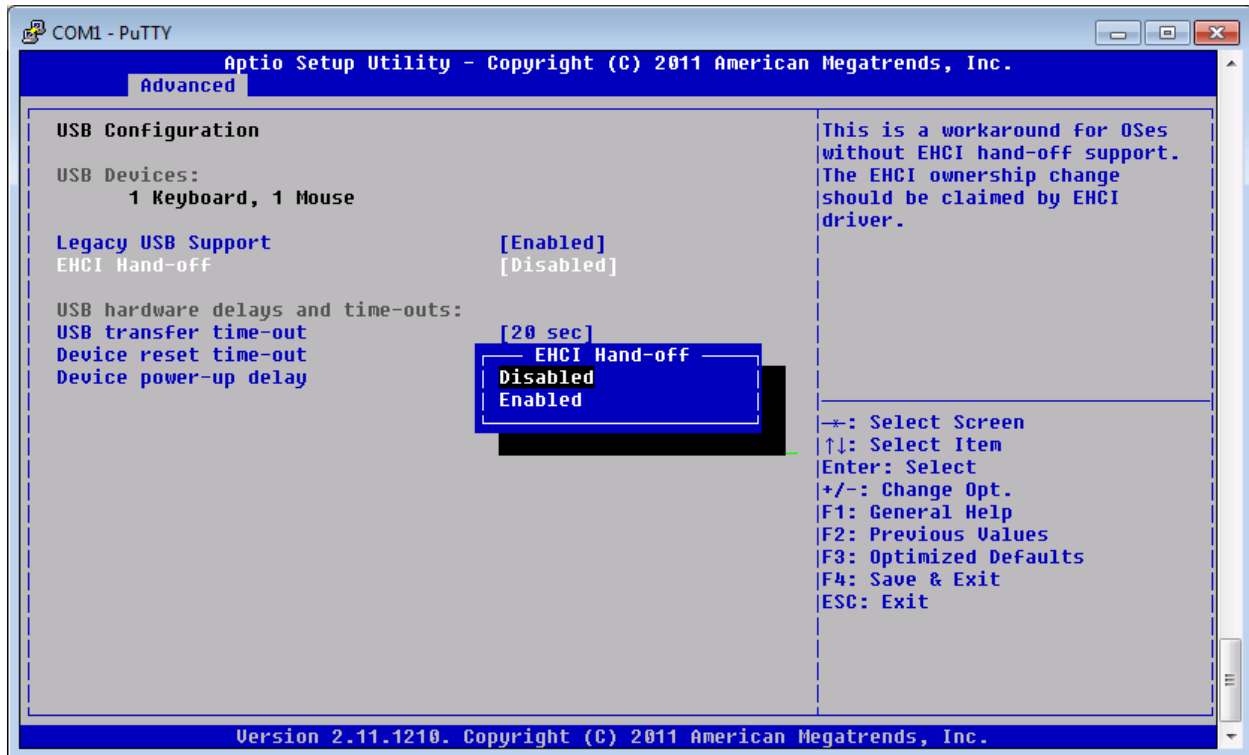

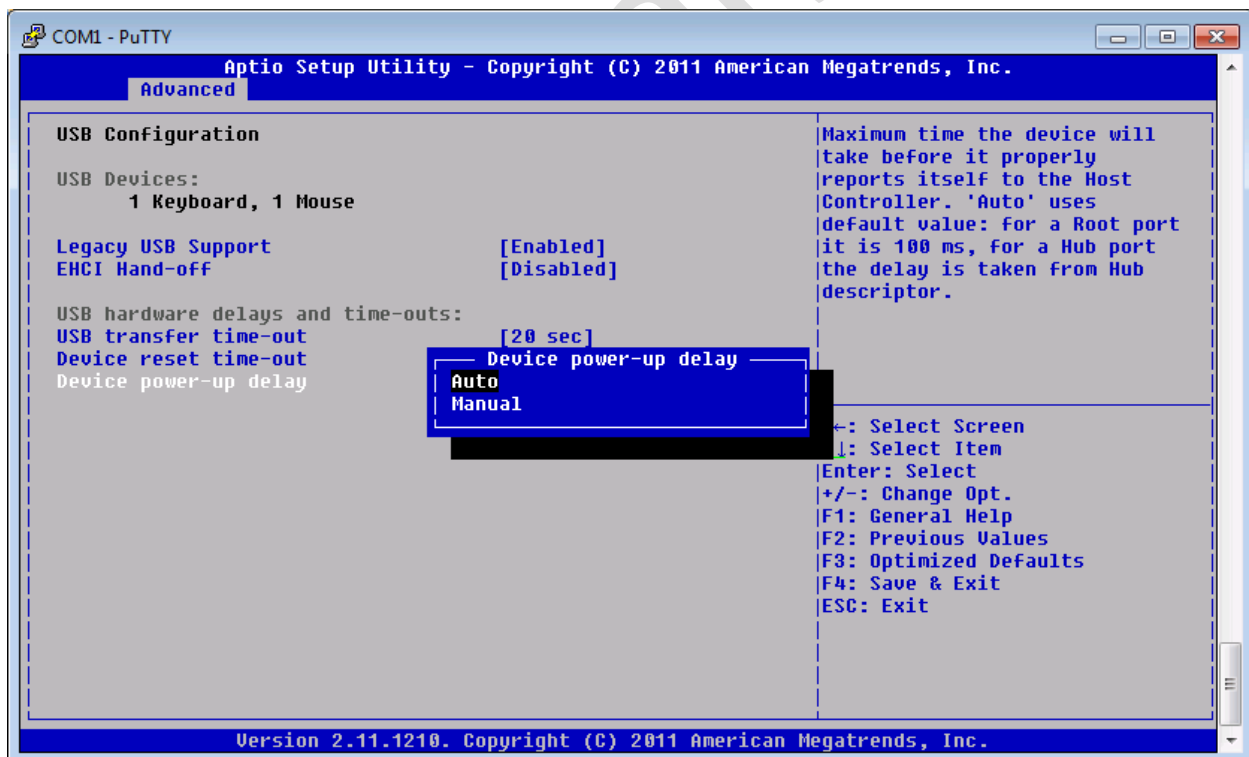
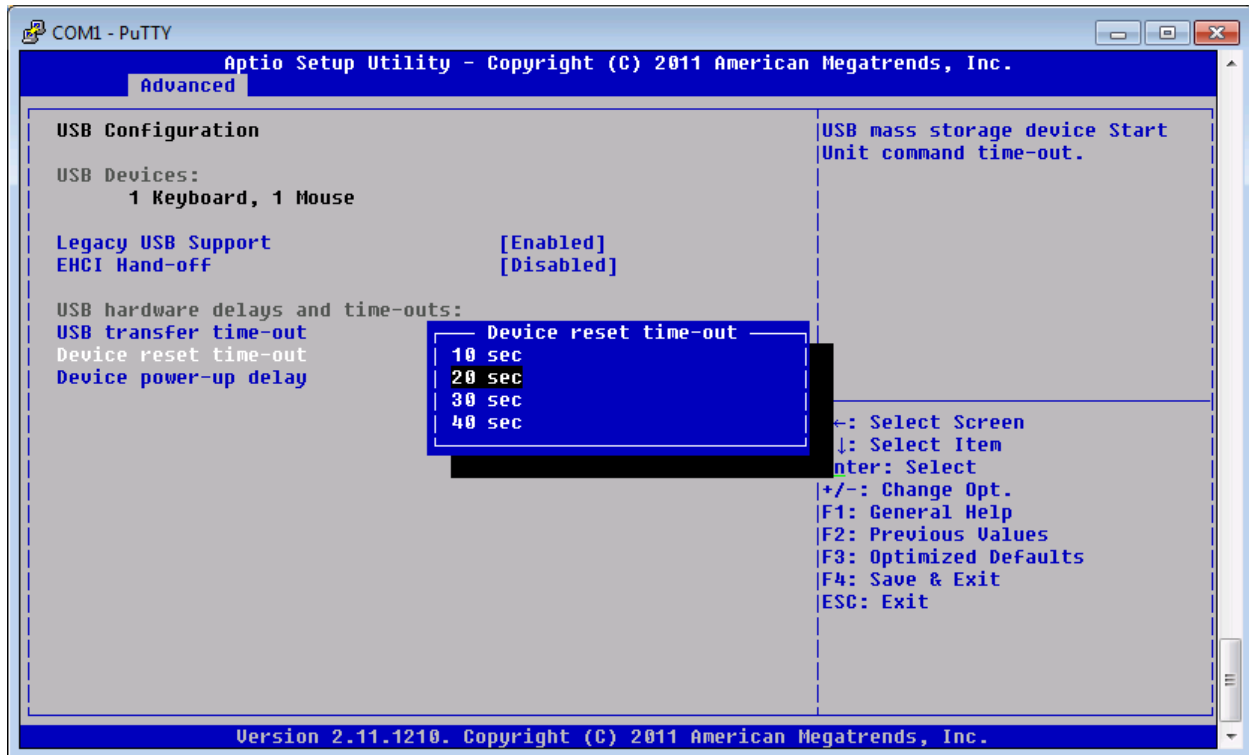

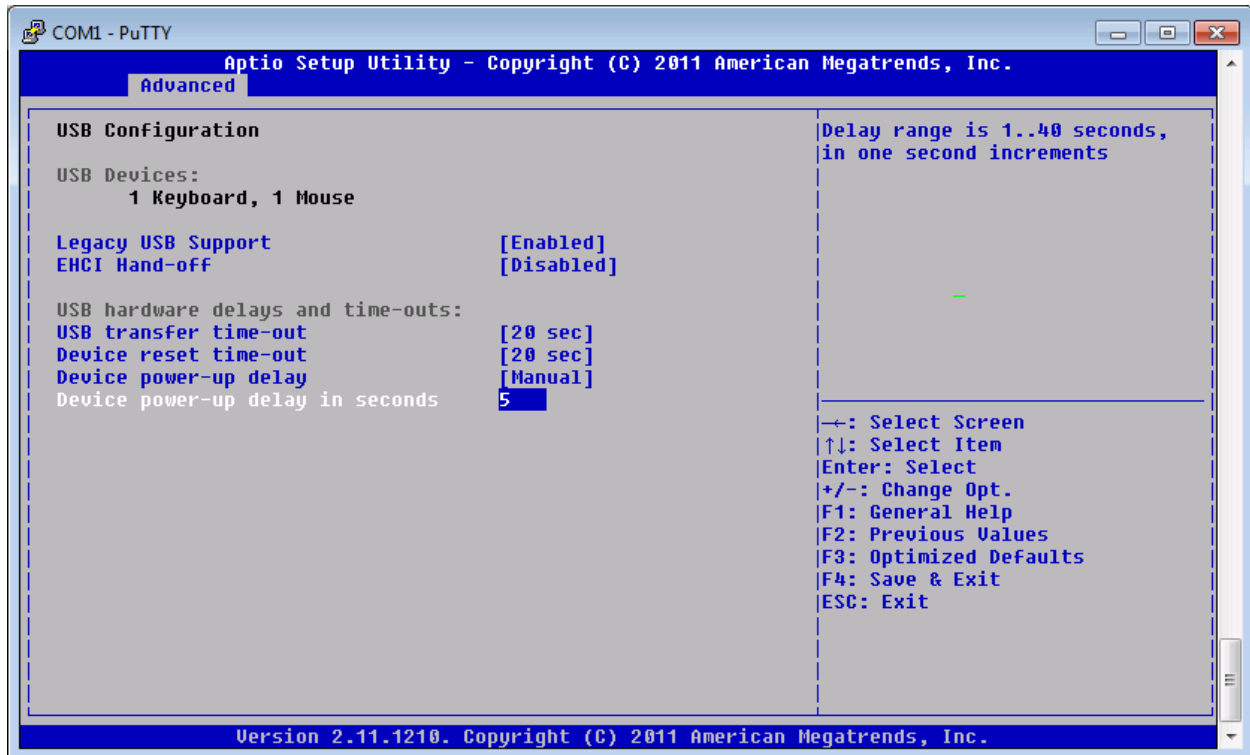

Super I/O Configuration

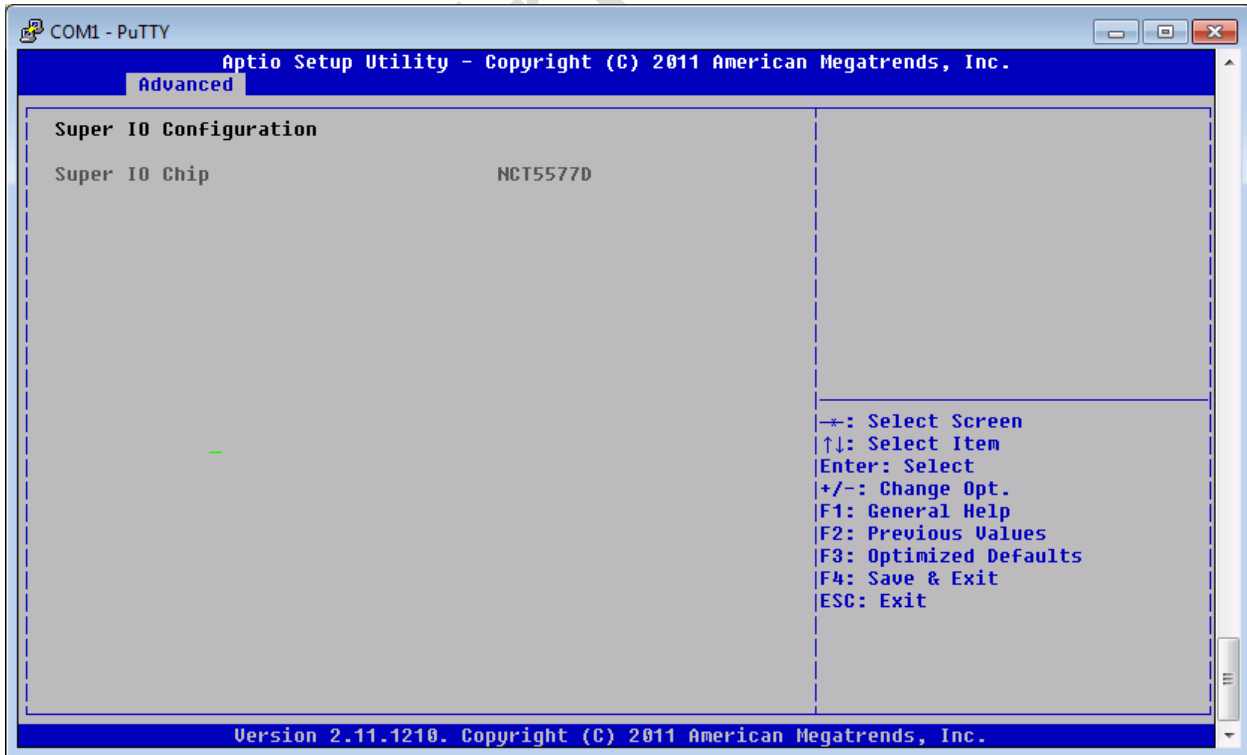
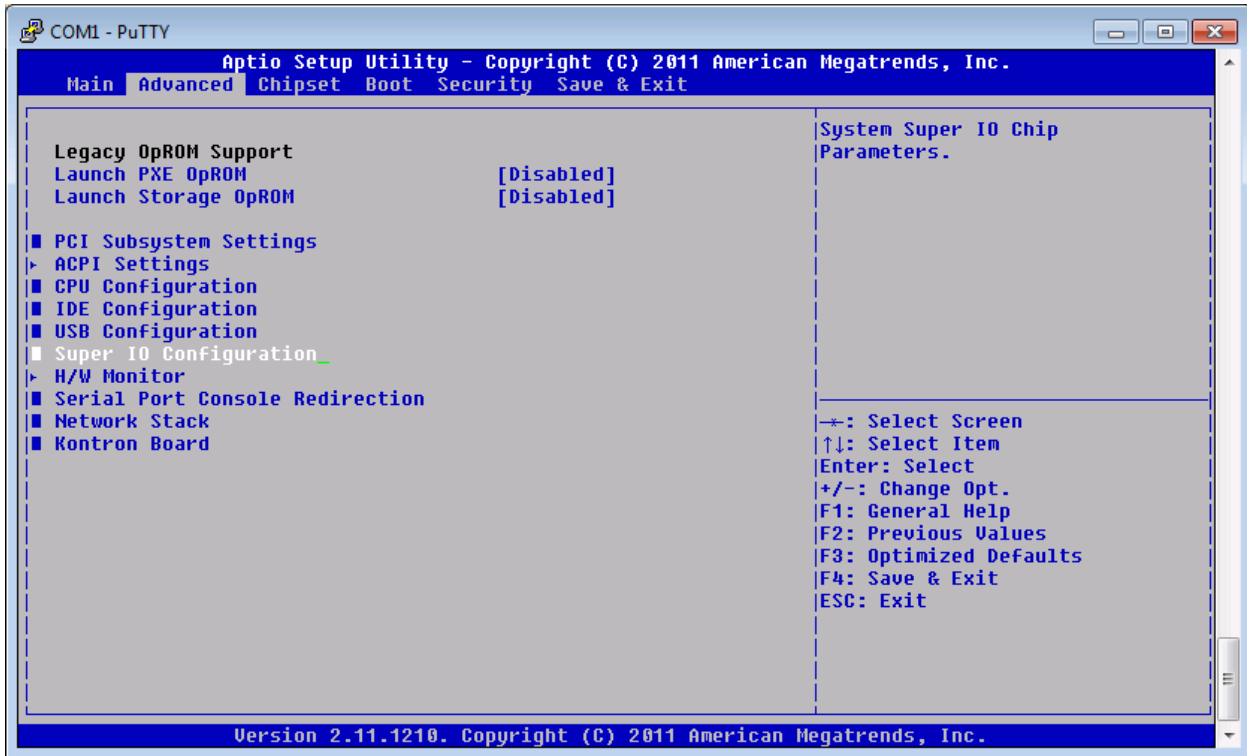

Hardware Monitor

NOTE: In the H/W Monitor submenu screen, the value at "5VSBY" is around 1.368 V. This exception low value is caused by the target hardware module that uses old resister values. These H/W Monitor pictures need to be replaced later, by the new hardware versions)

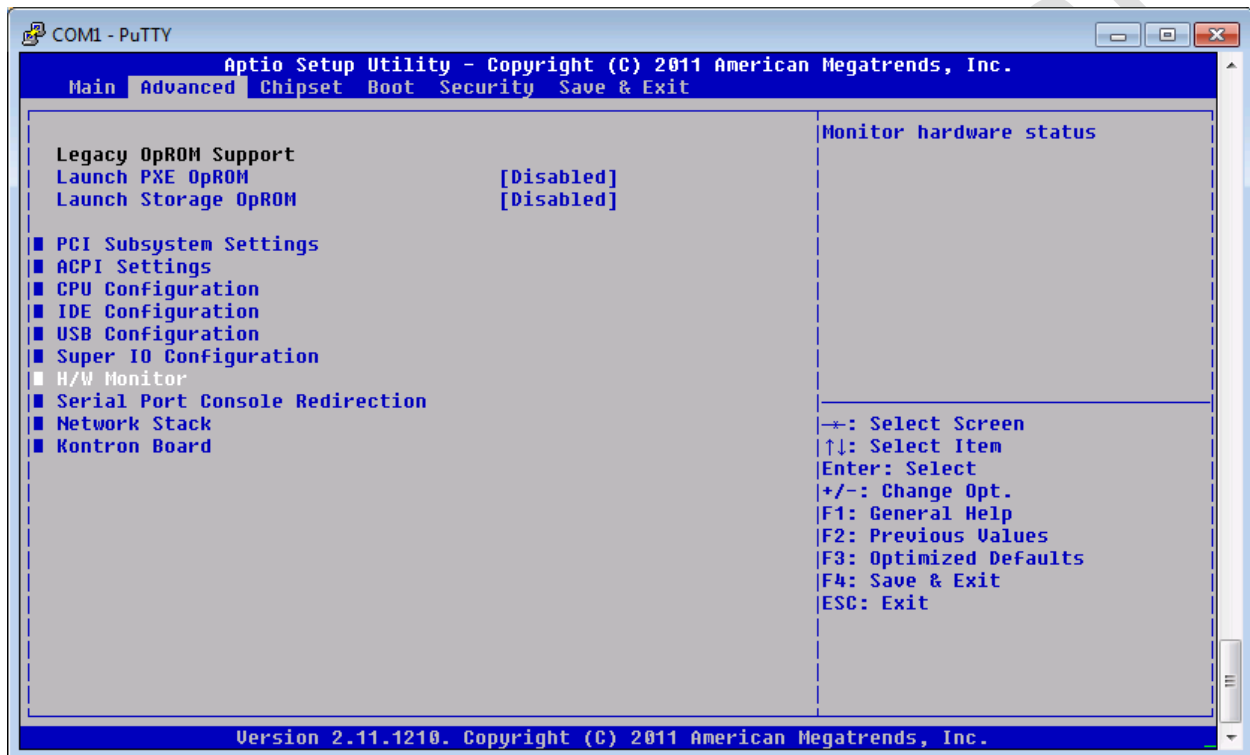

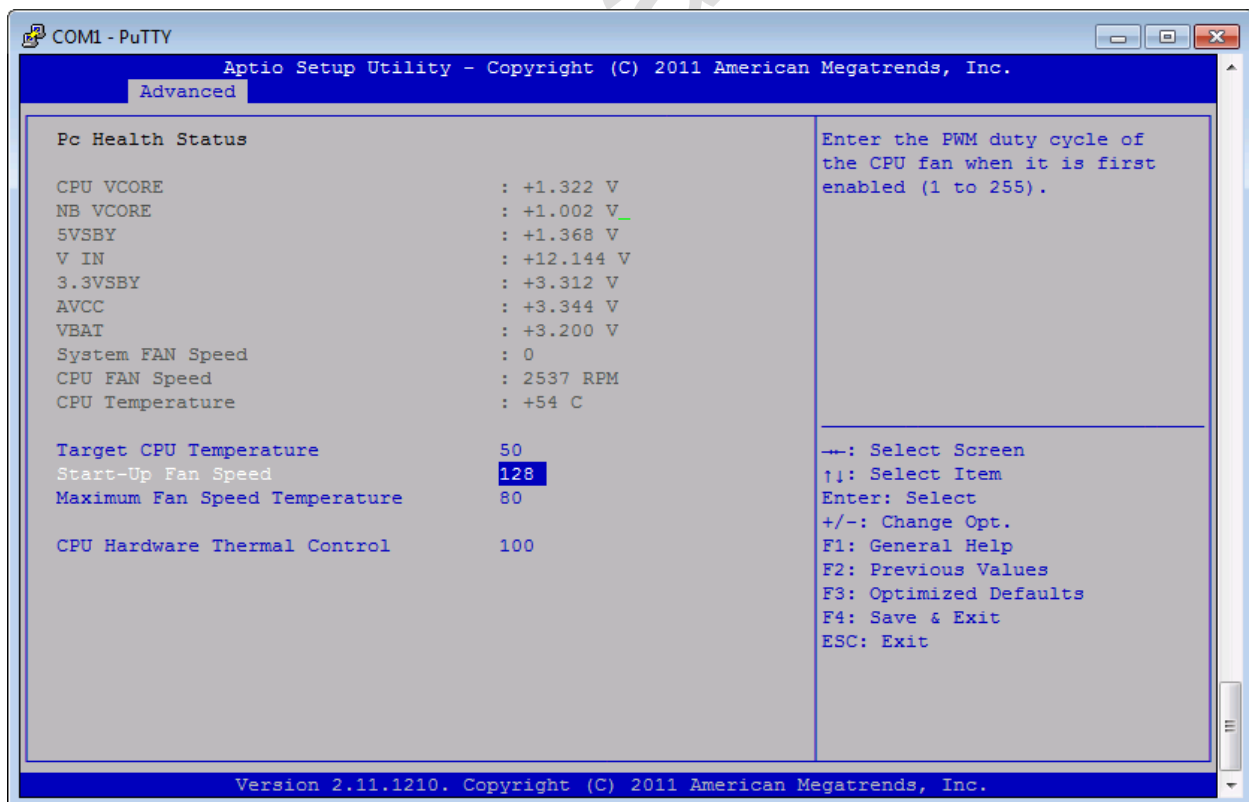
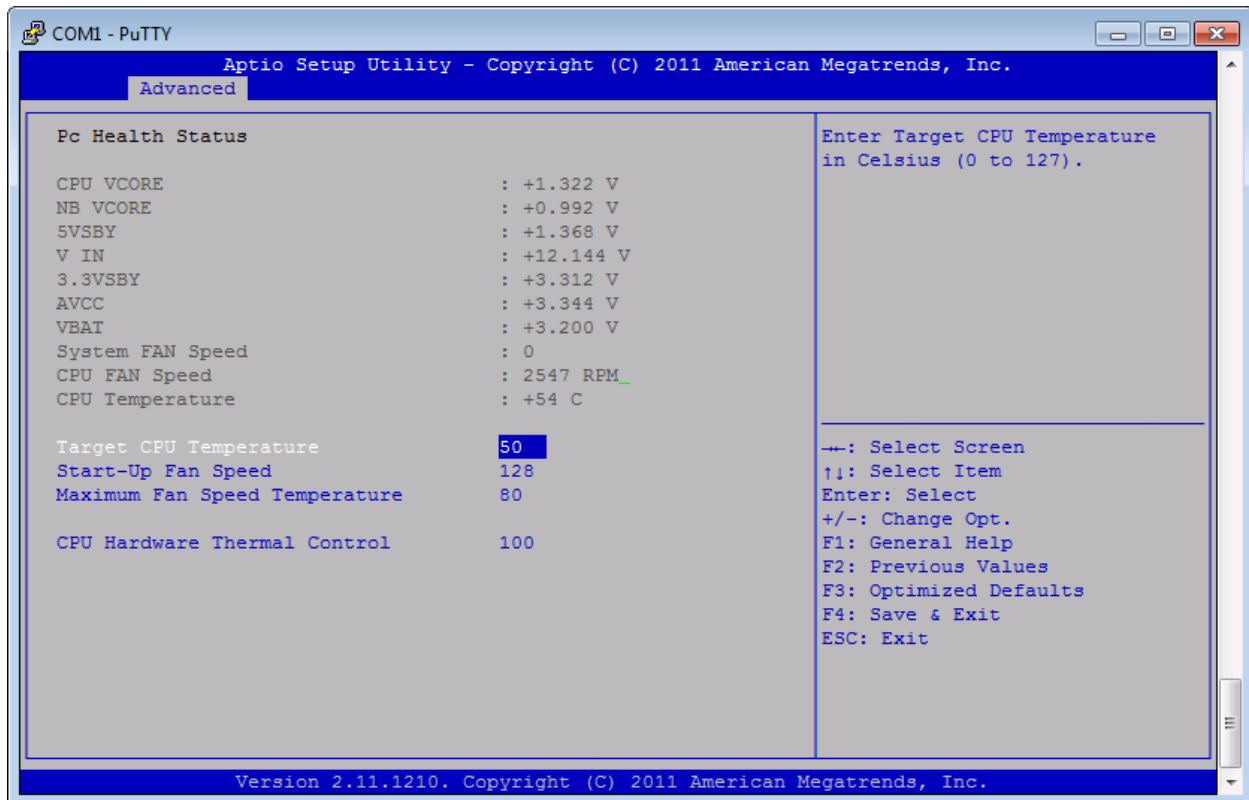

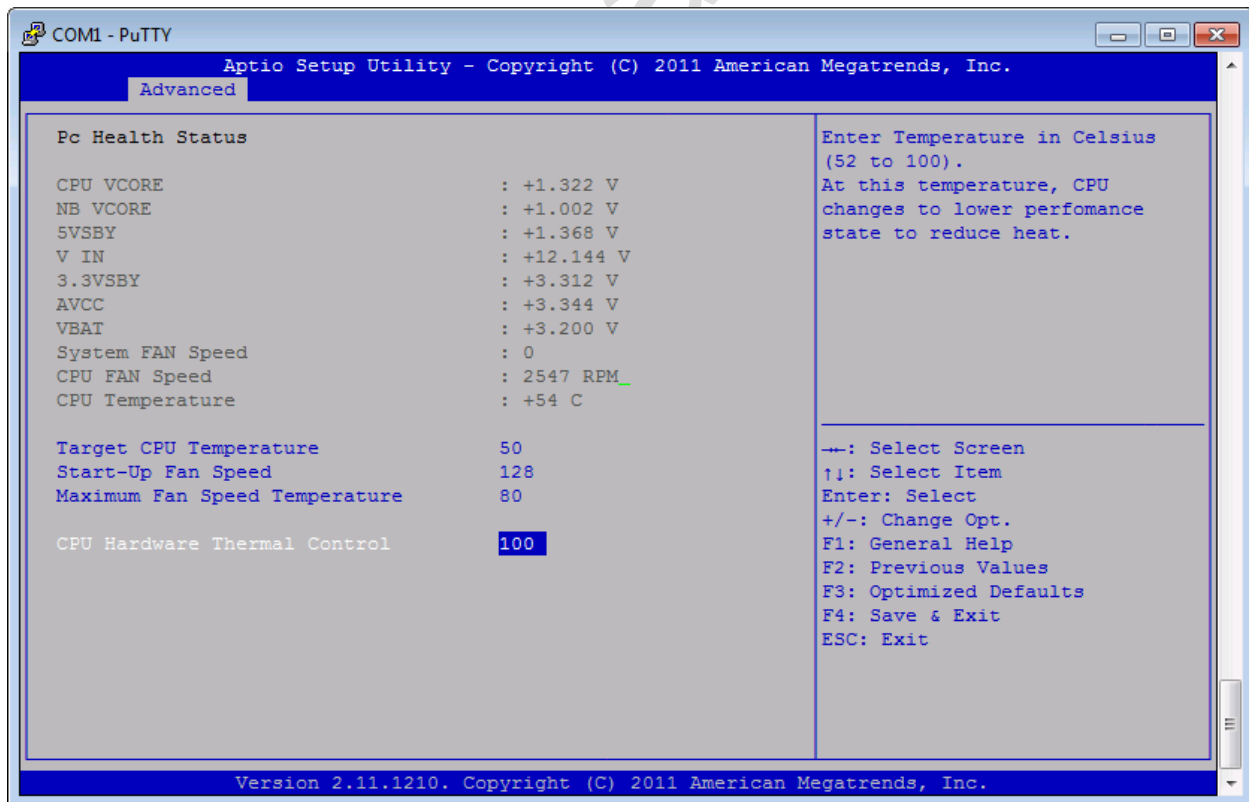
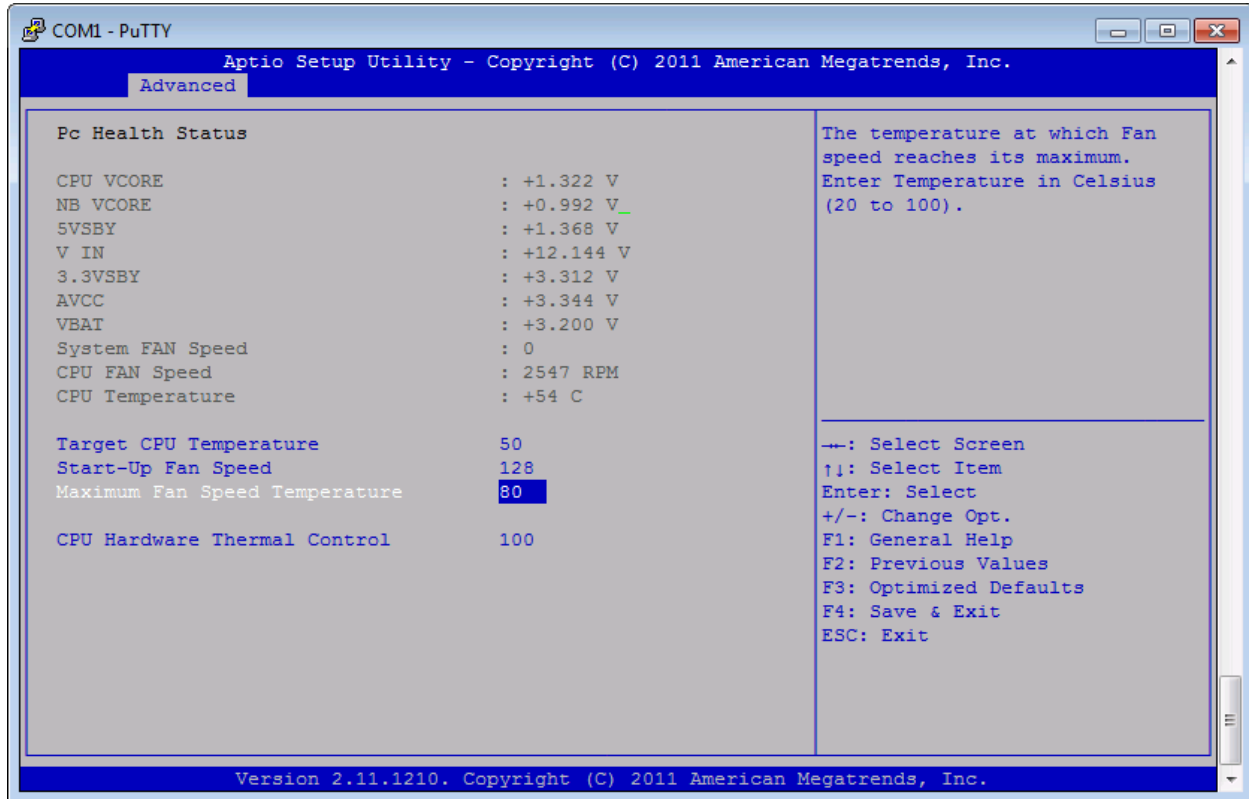

Serial Port Console Redirection

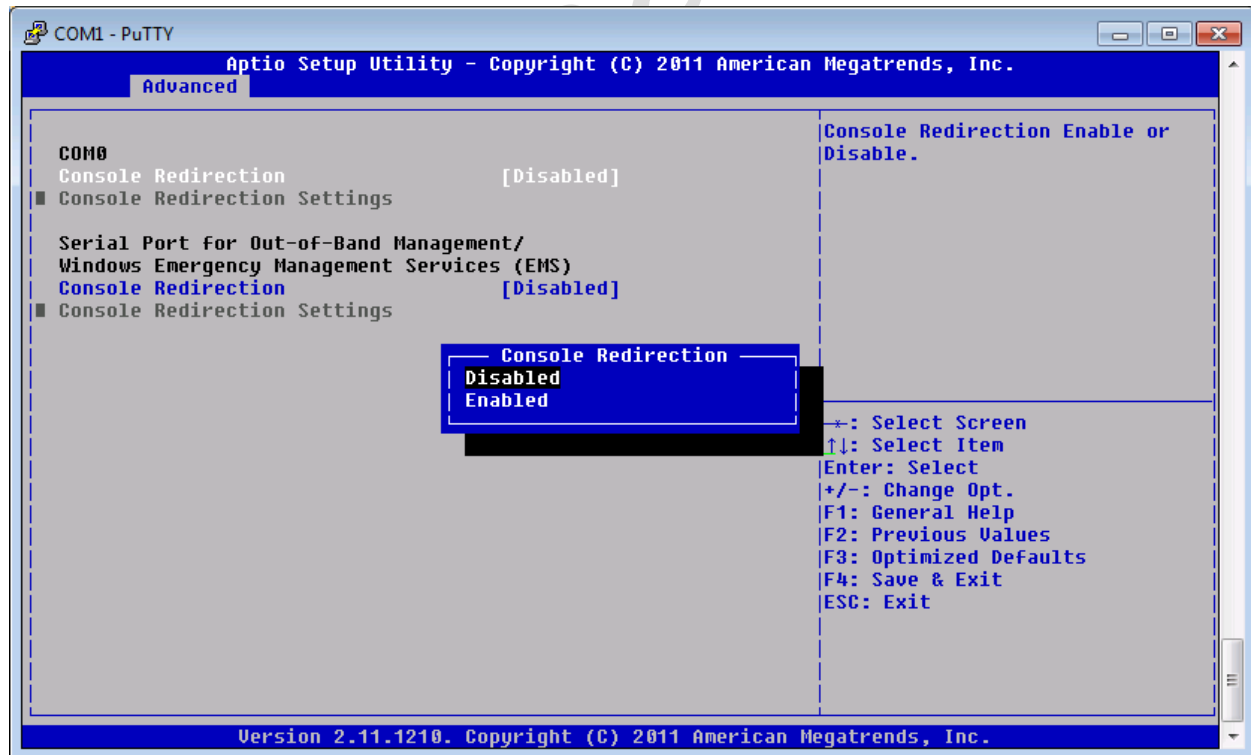
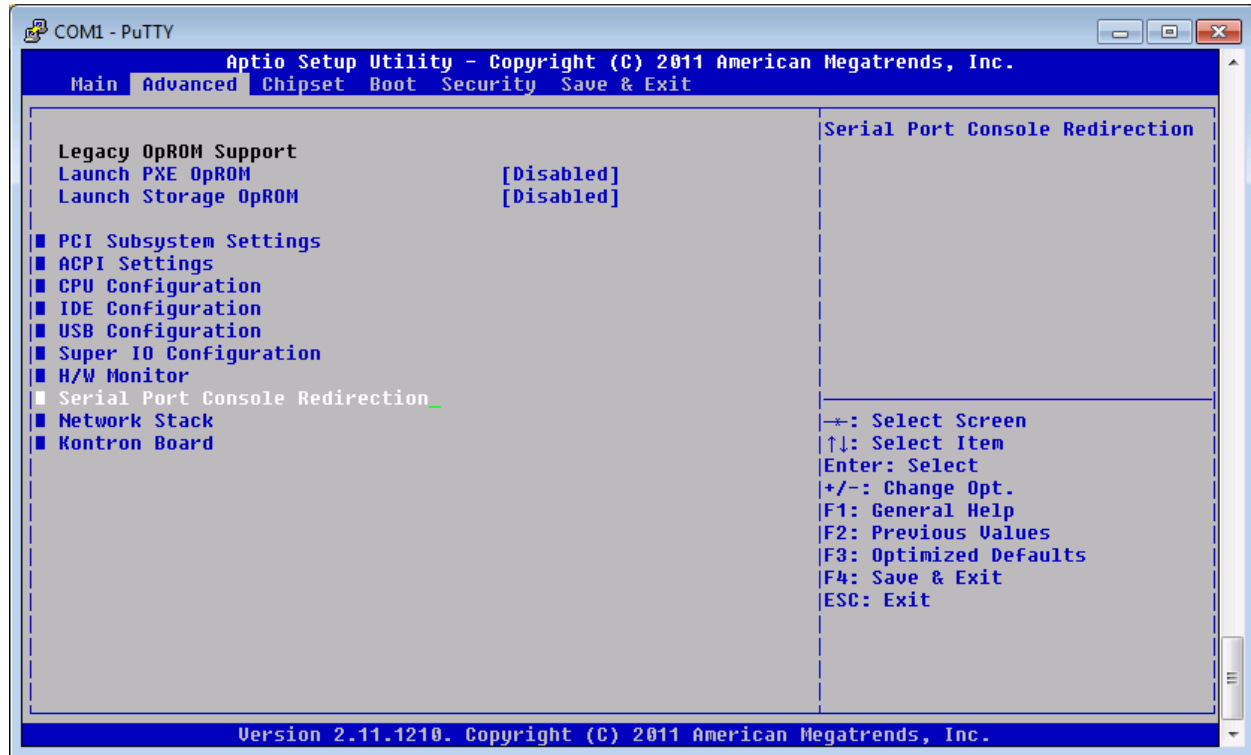

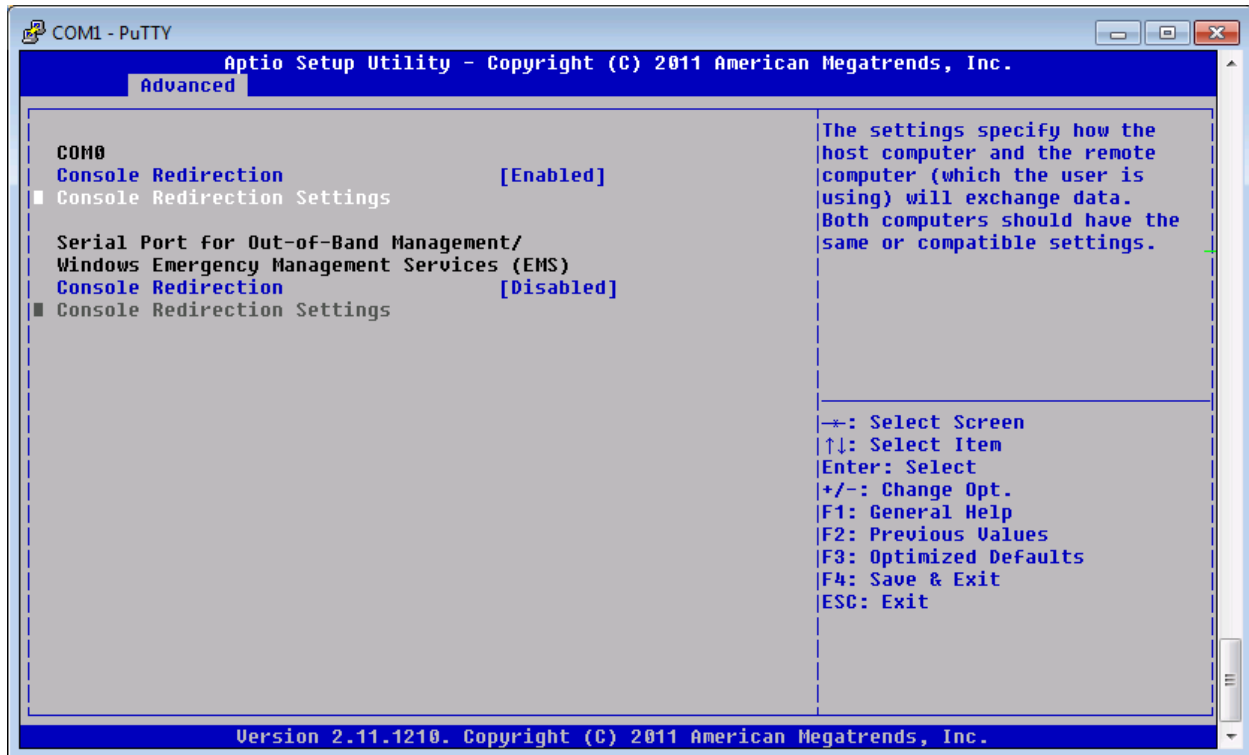

Console Redirection Settings -- First

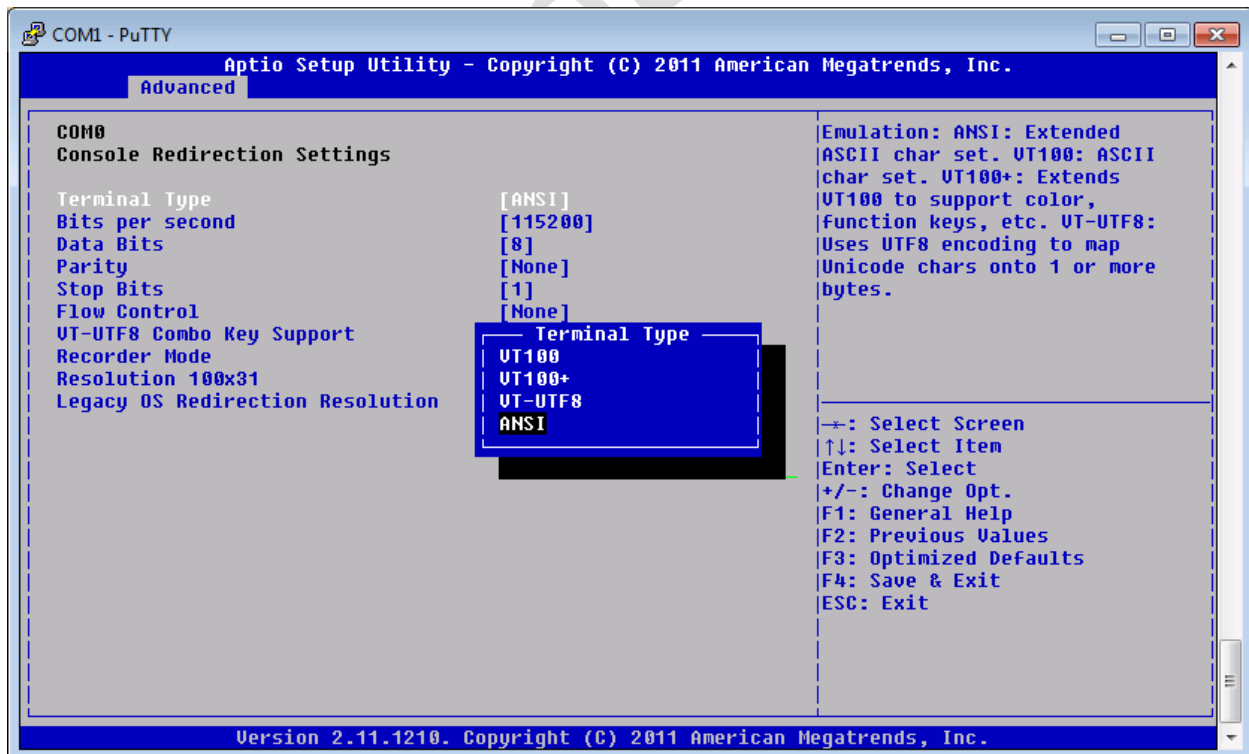

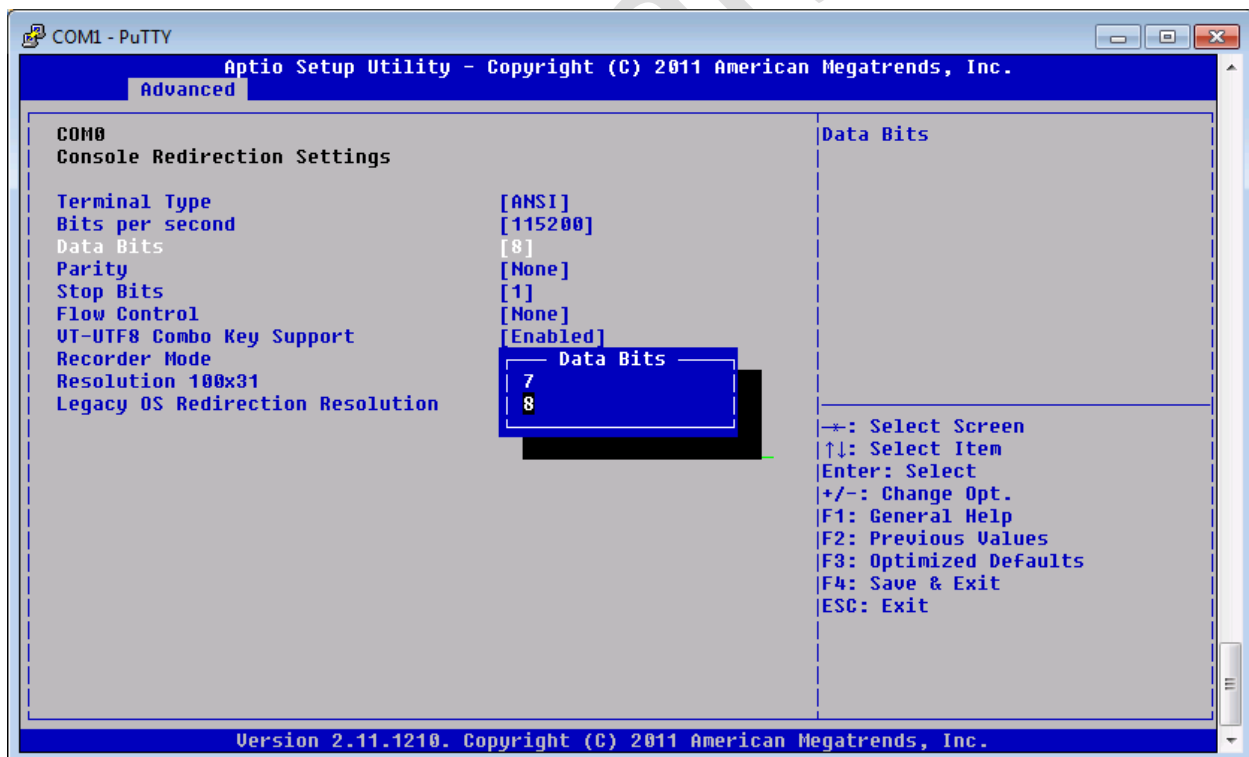
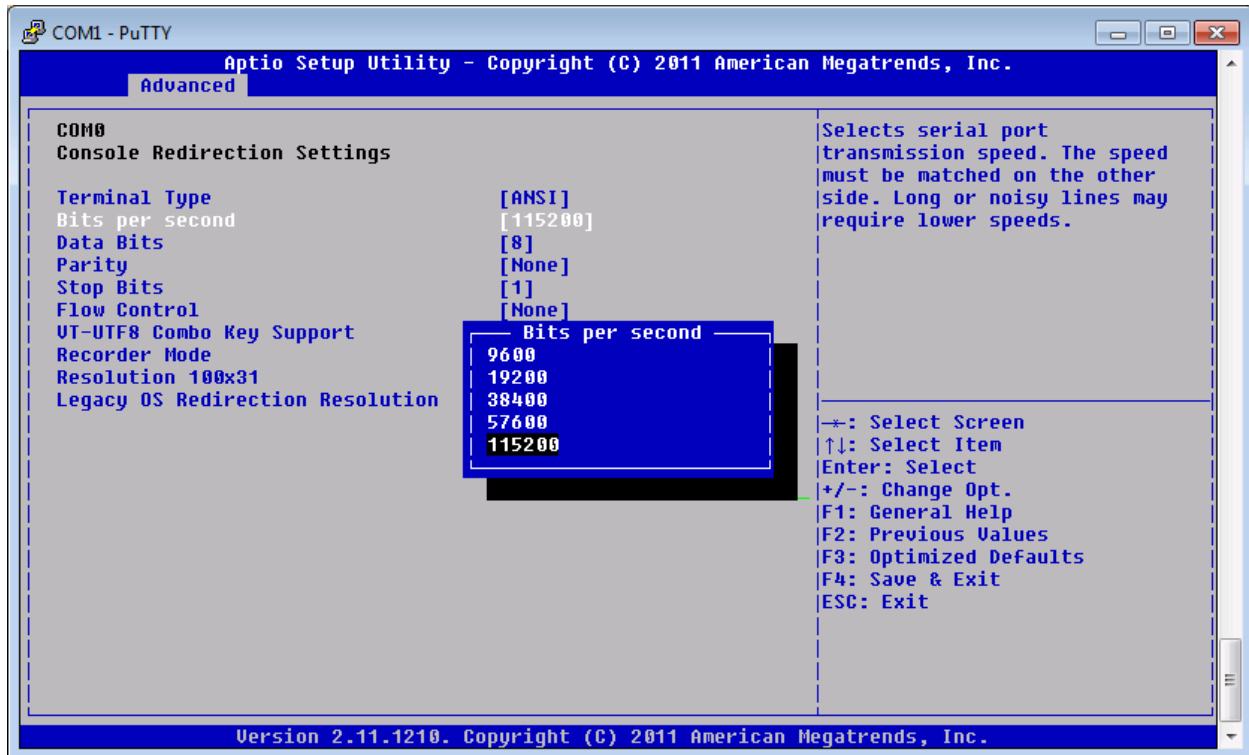

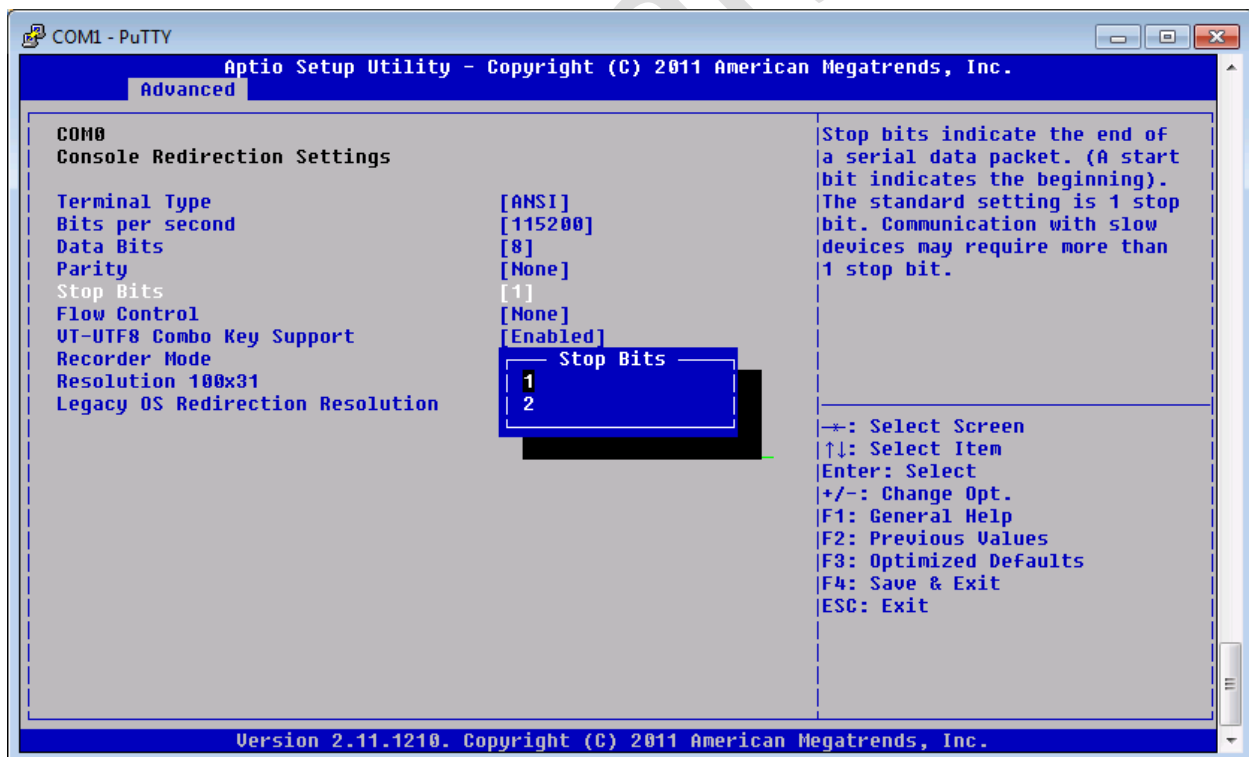
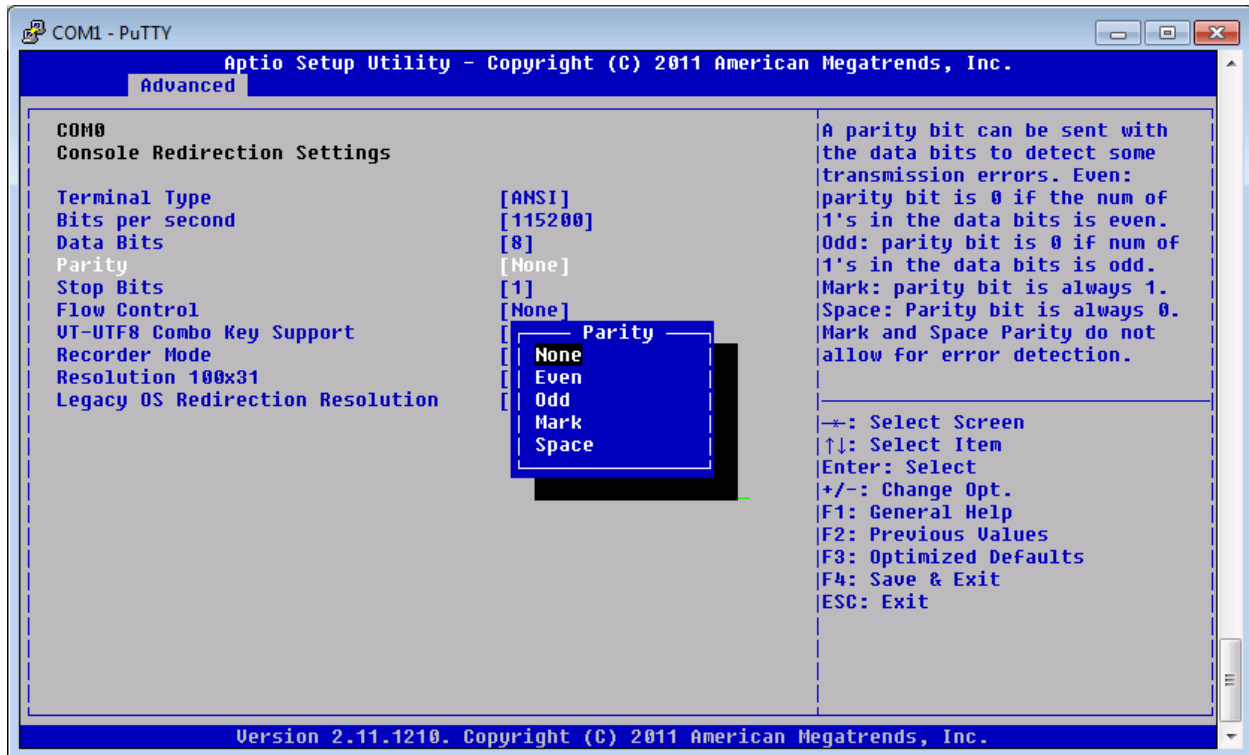

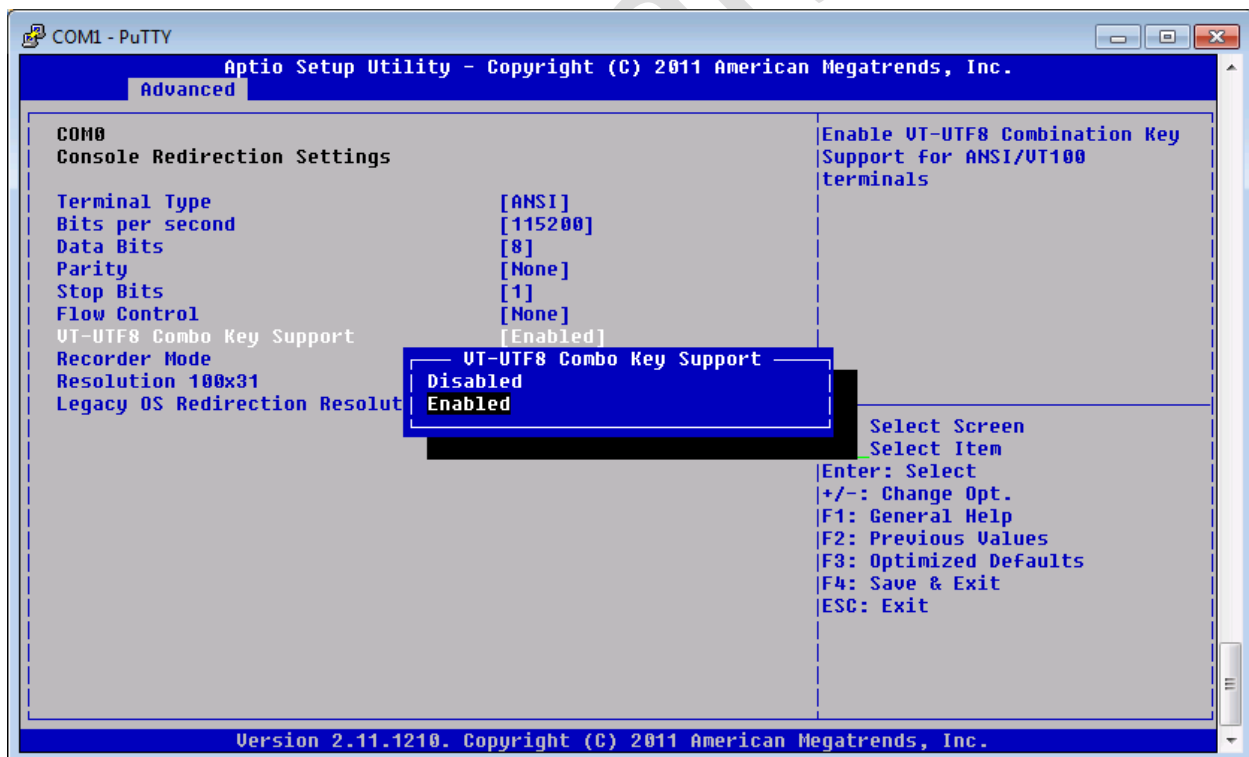
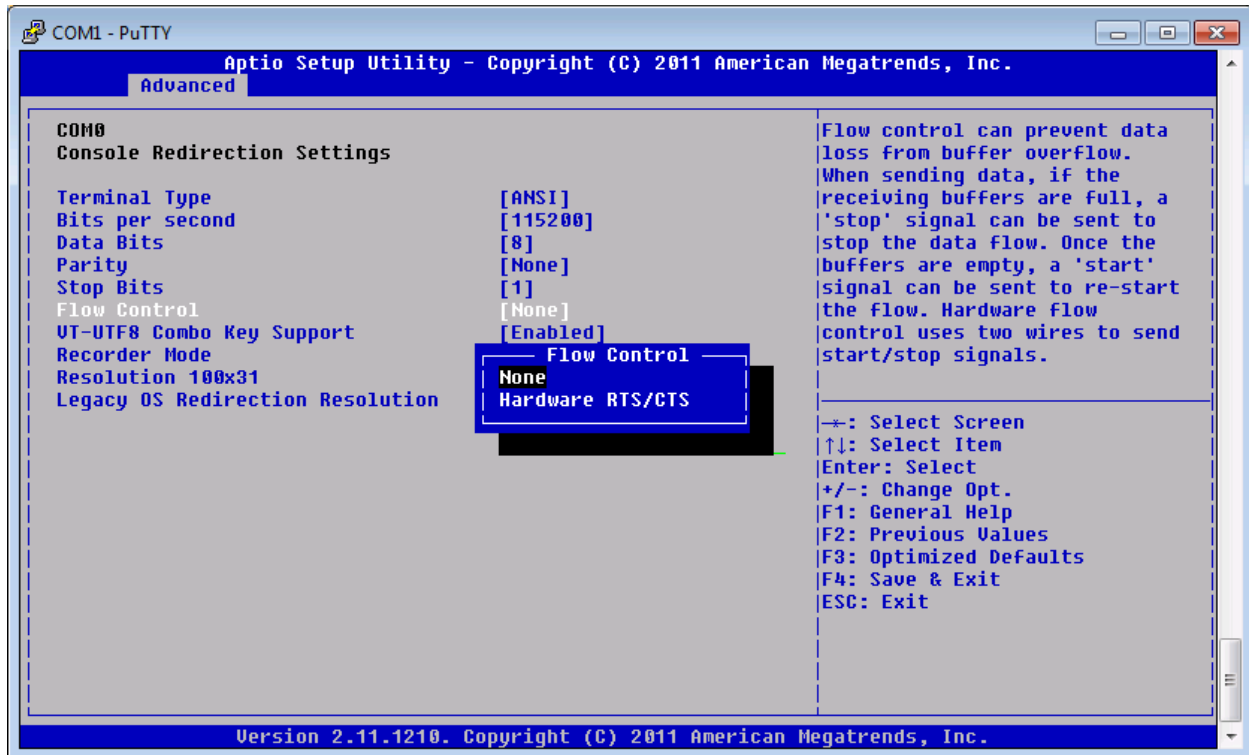

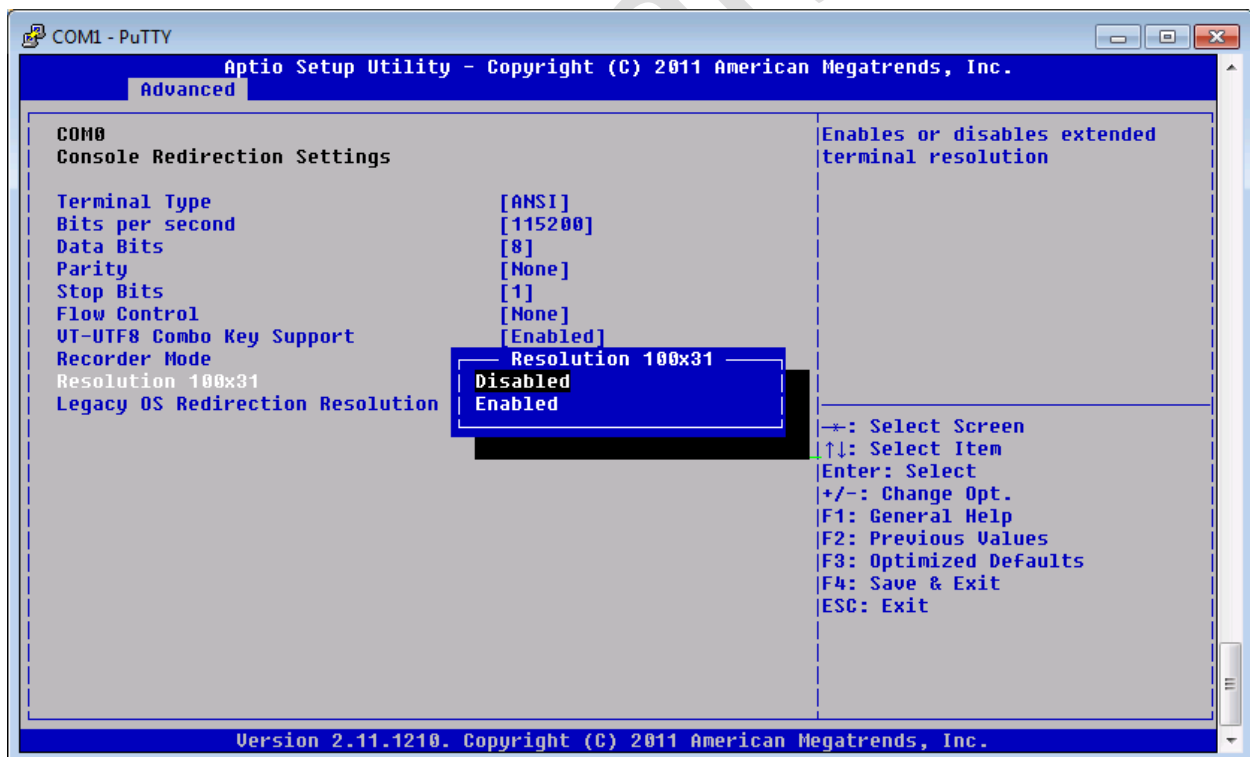
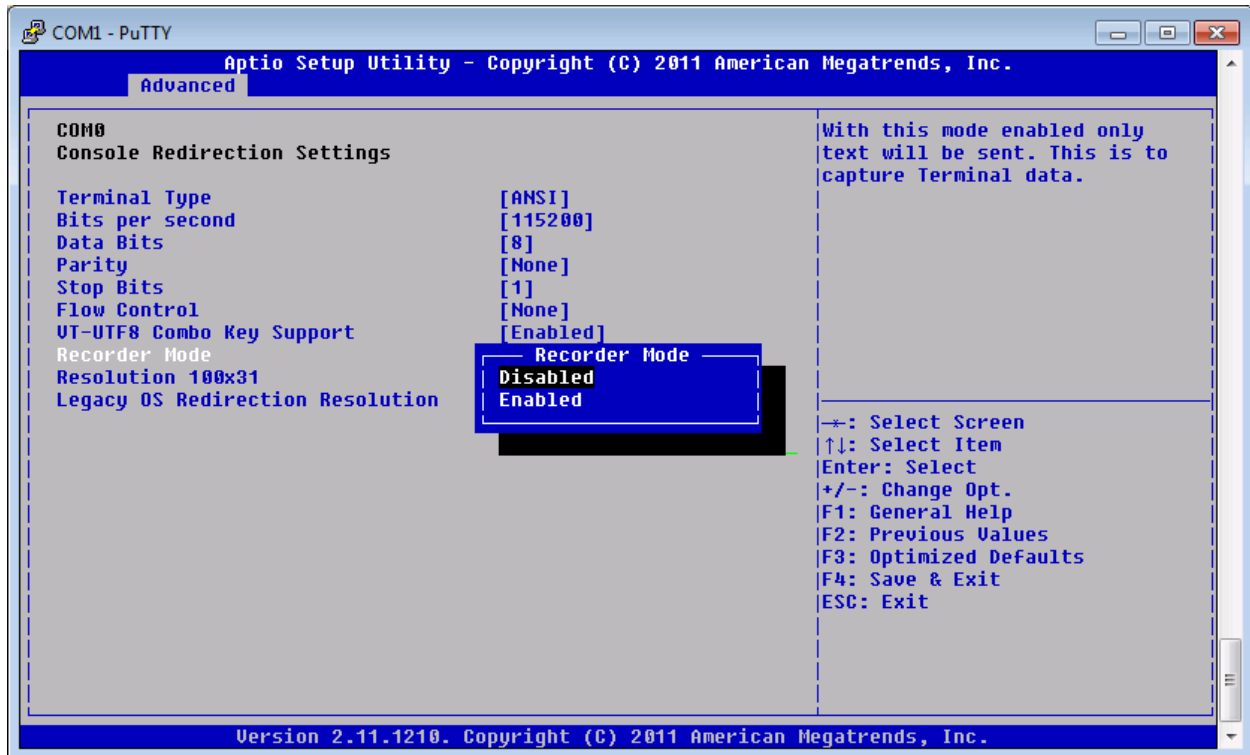

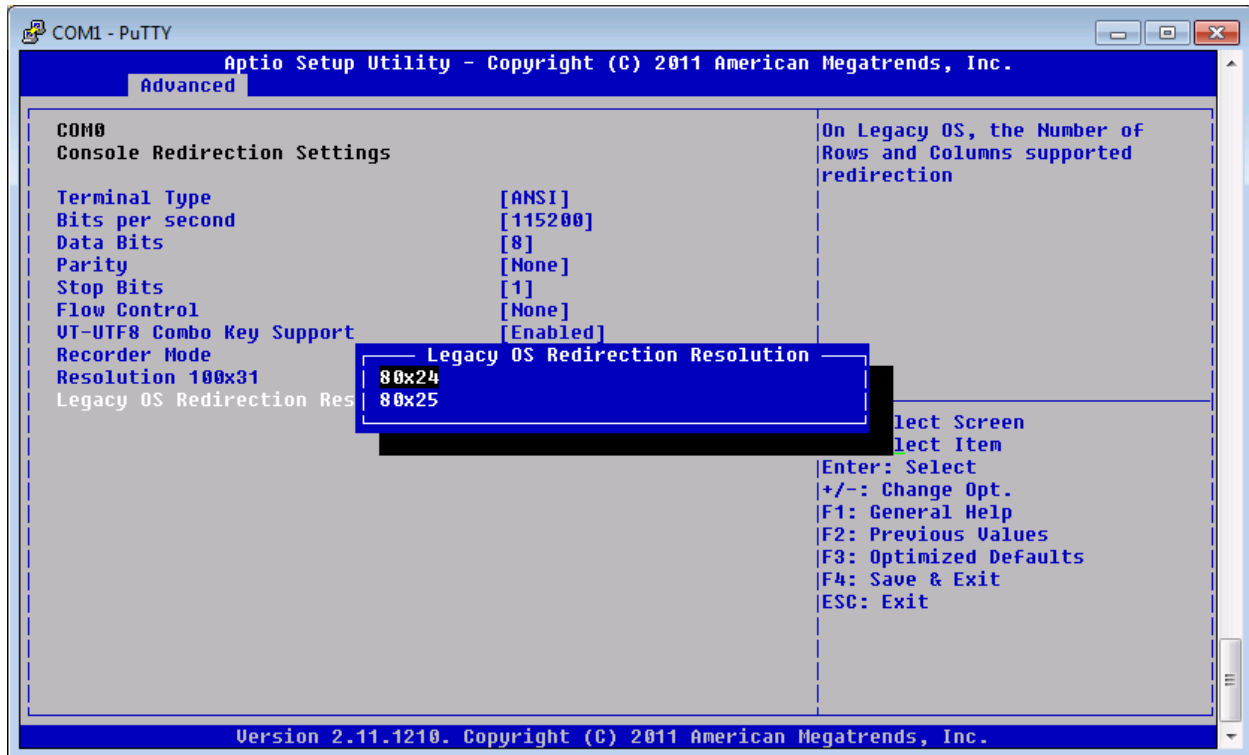

Console Redirection Settings -- Second

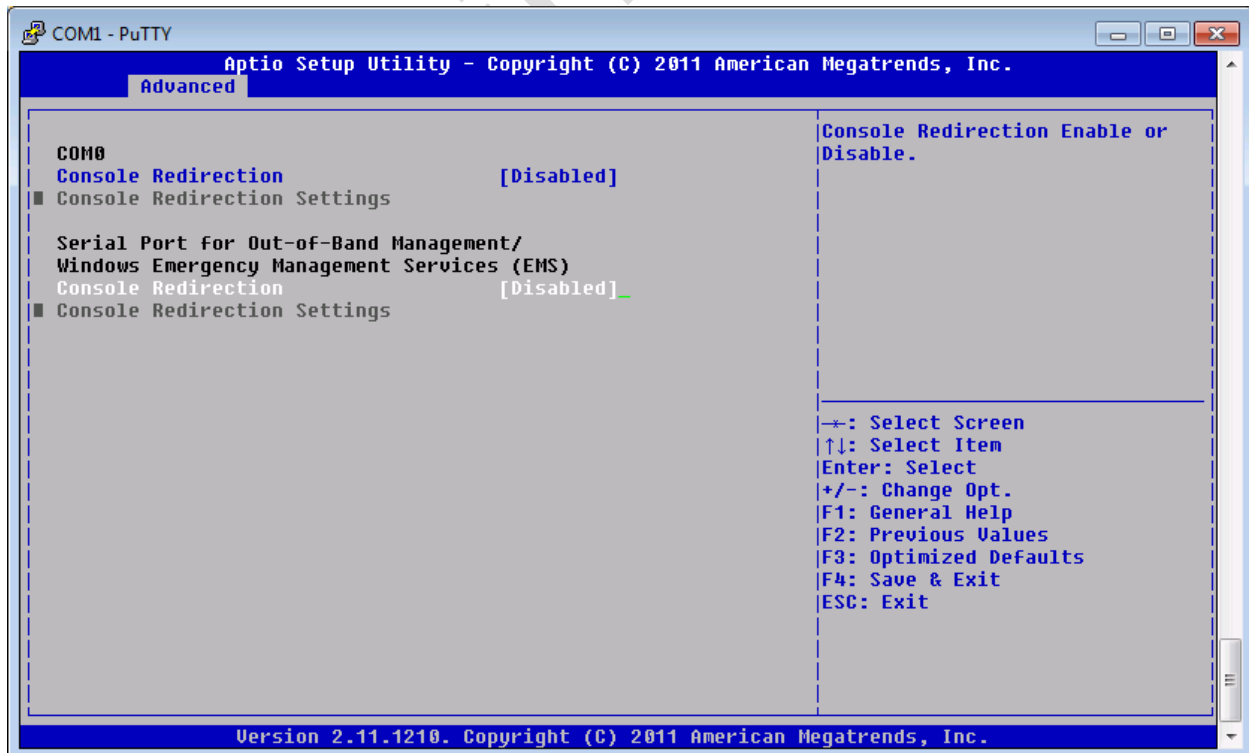

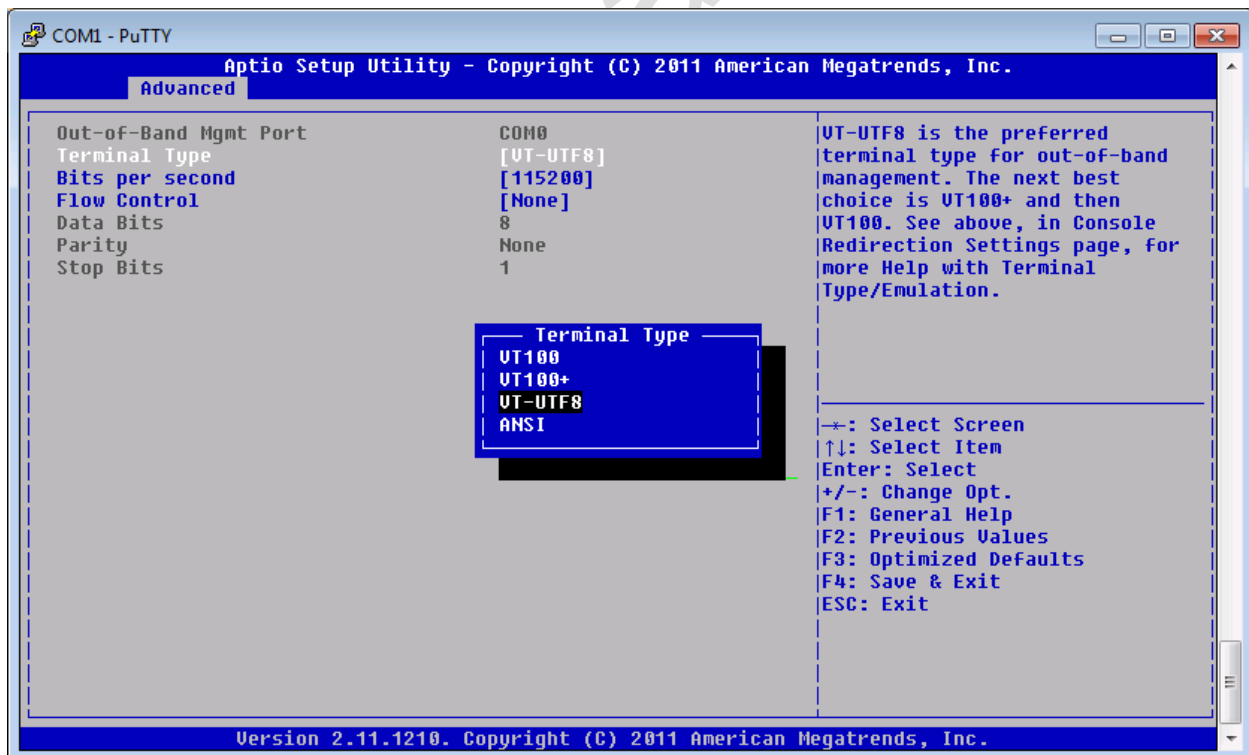
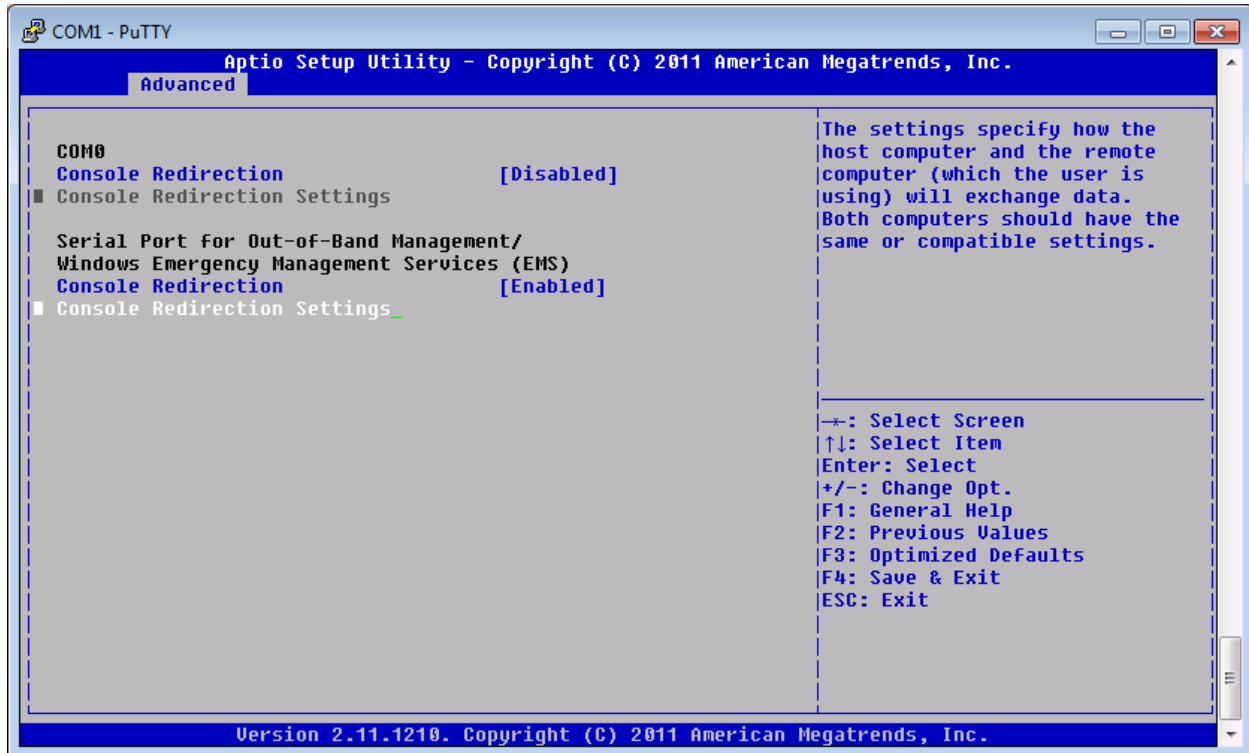

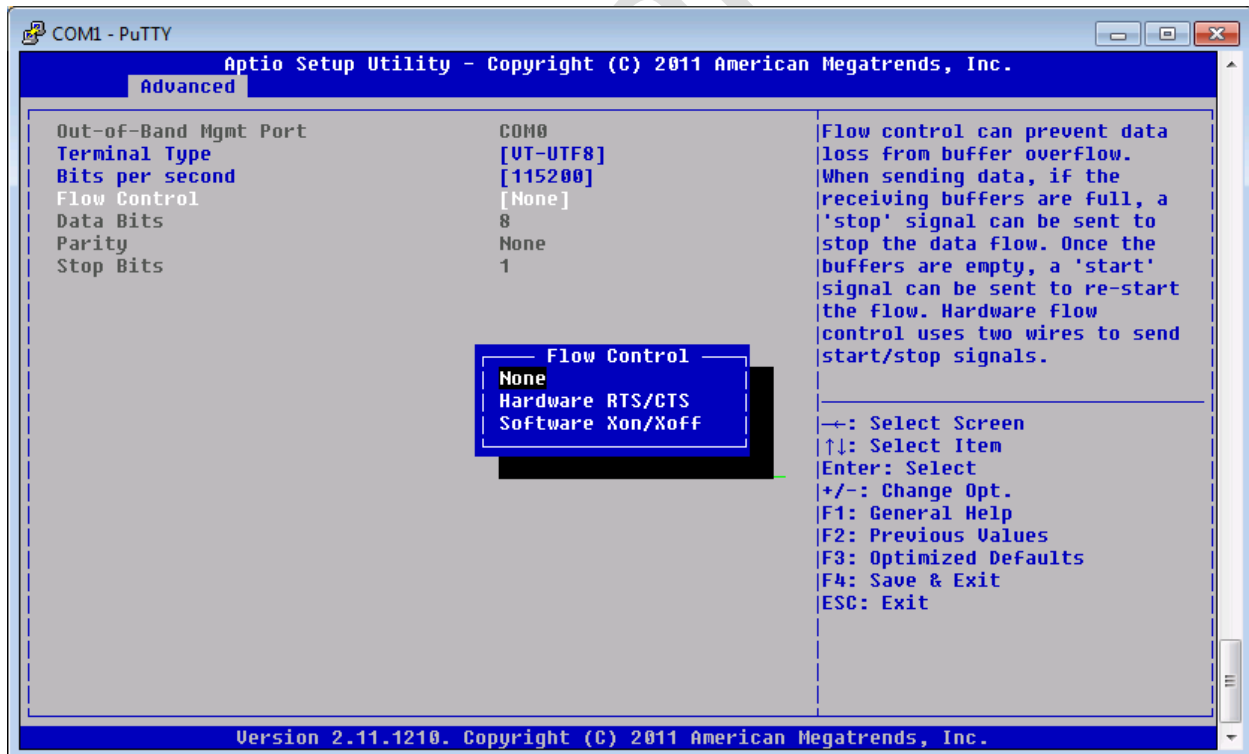
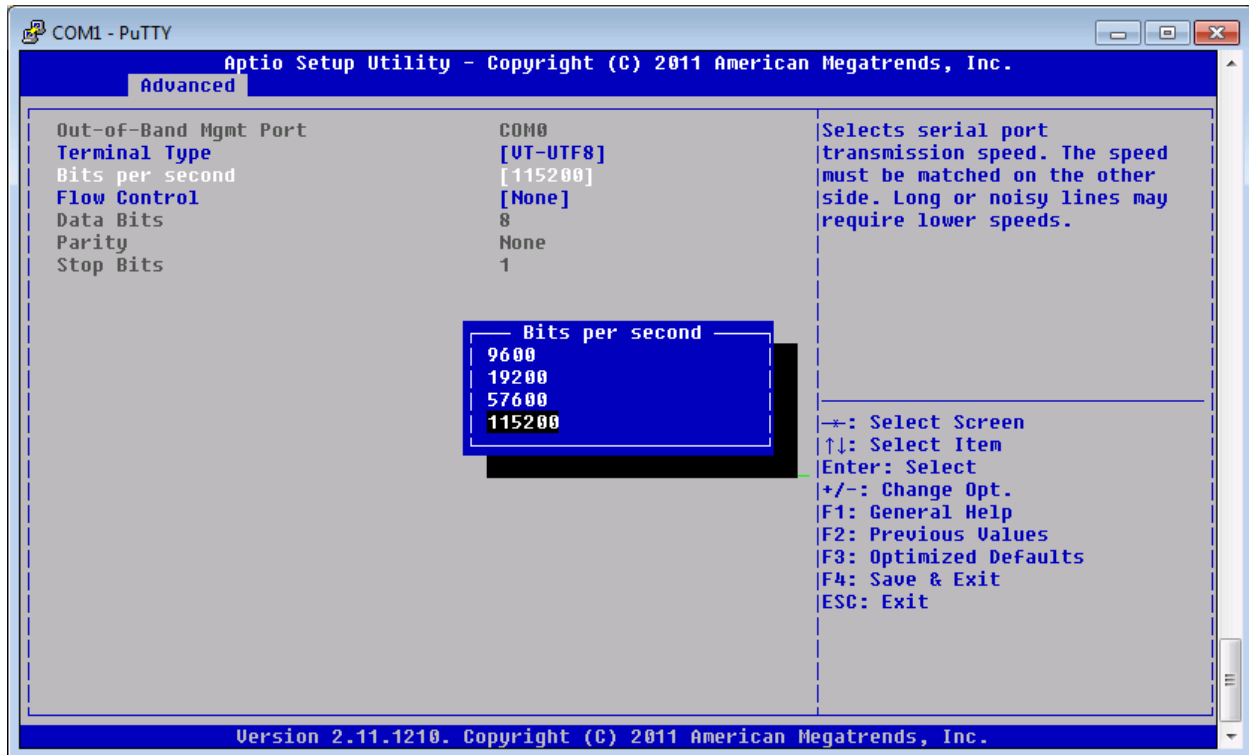

Network Stack

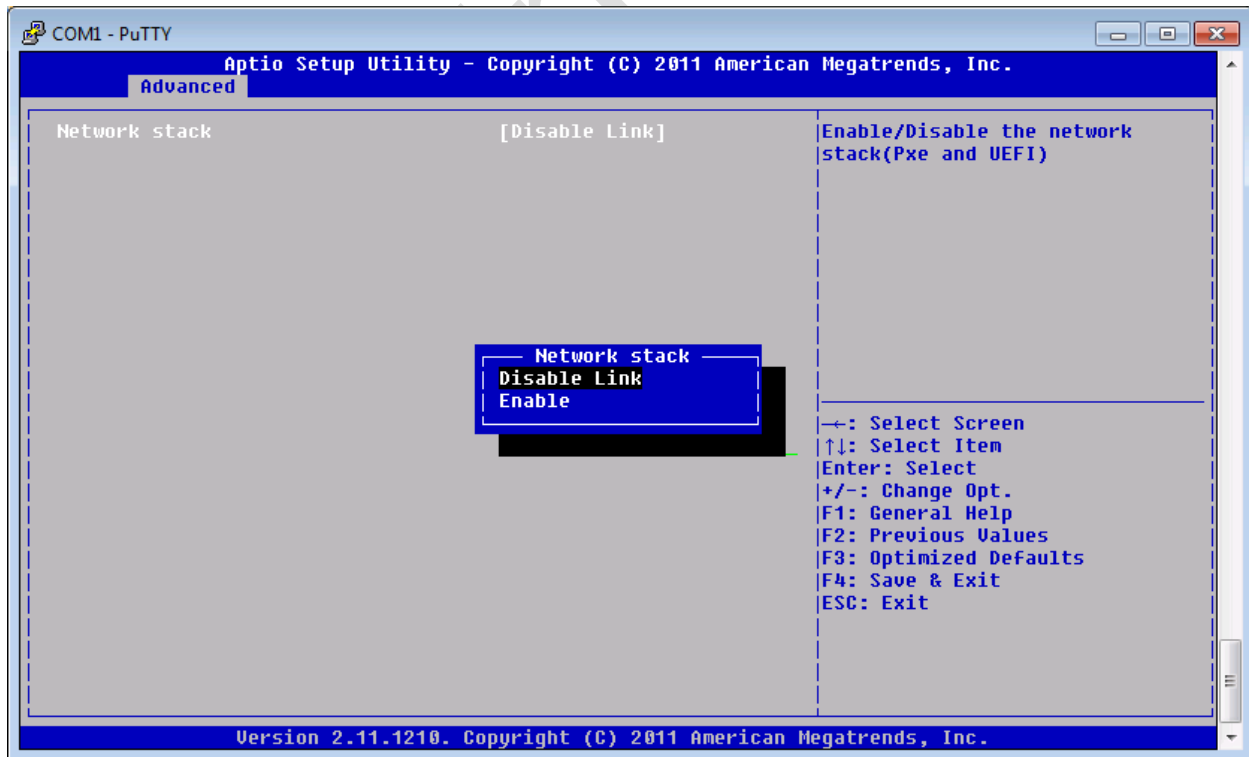
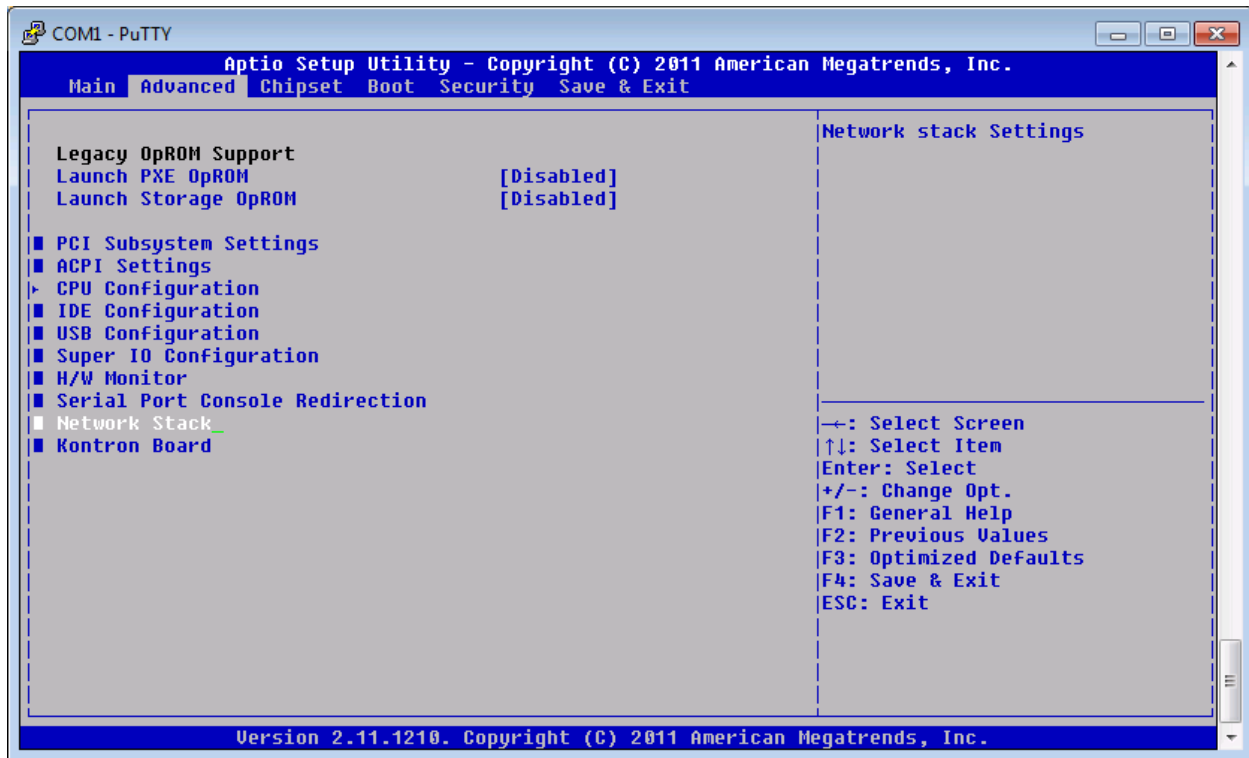

Kontron Board

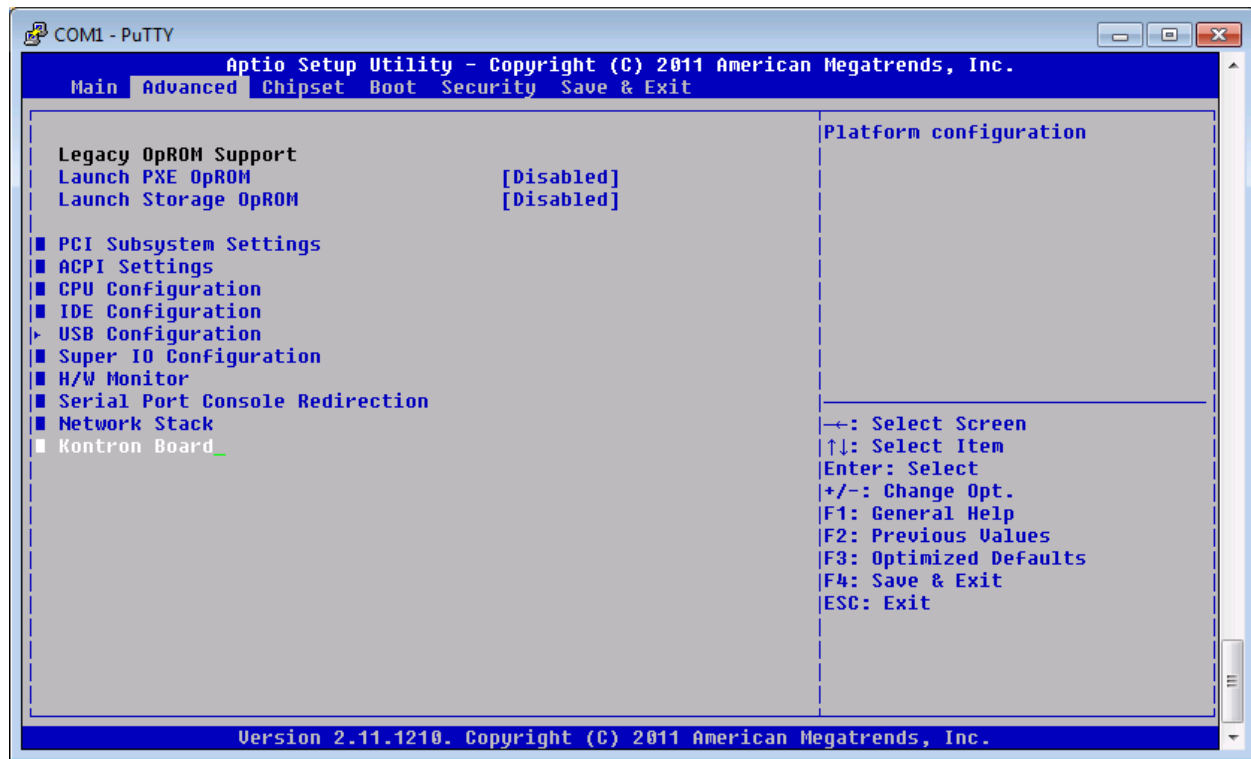

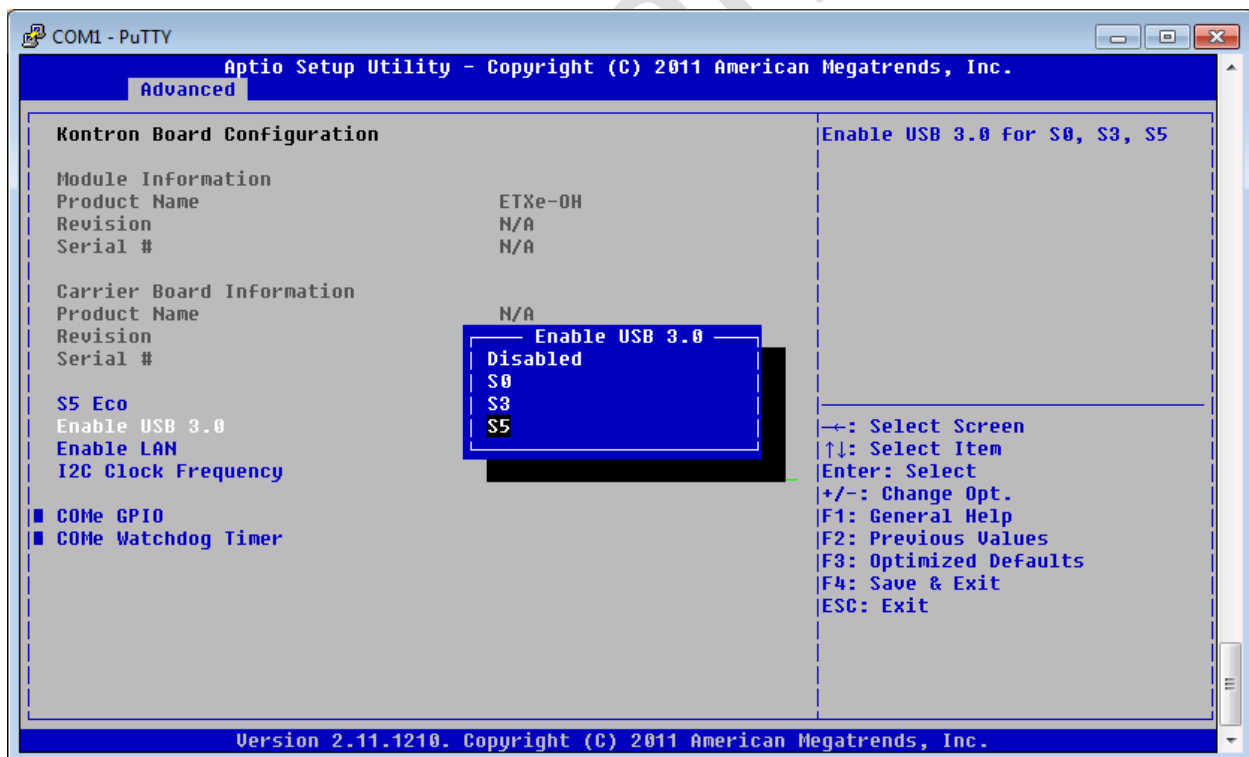
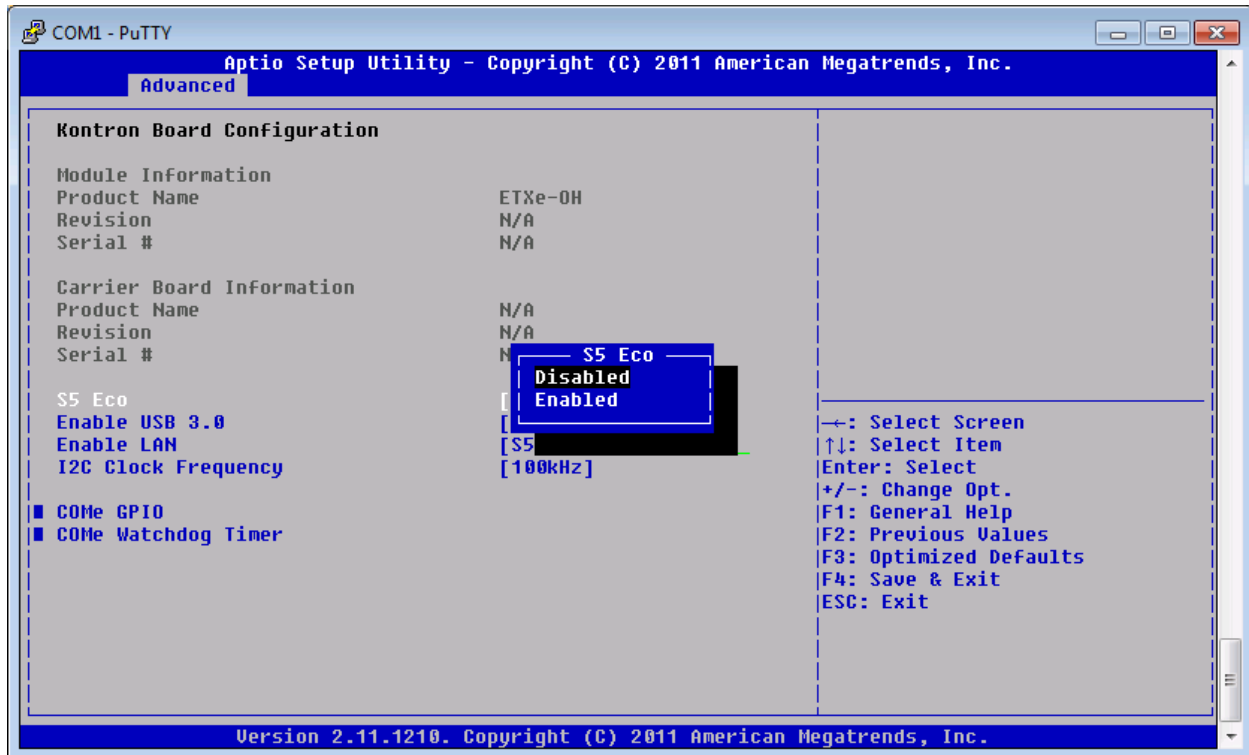

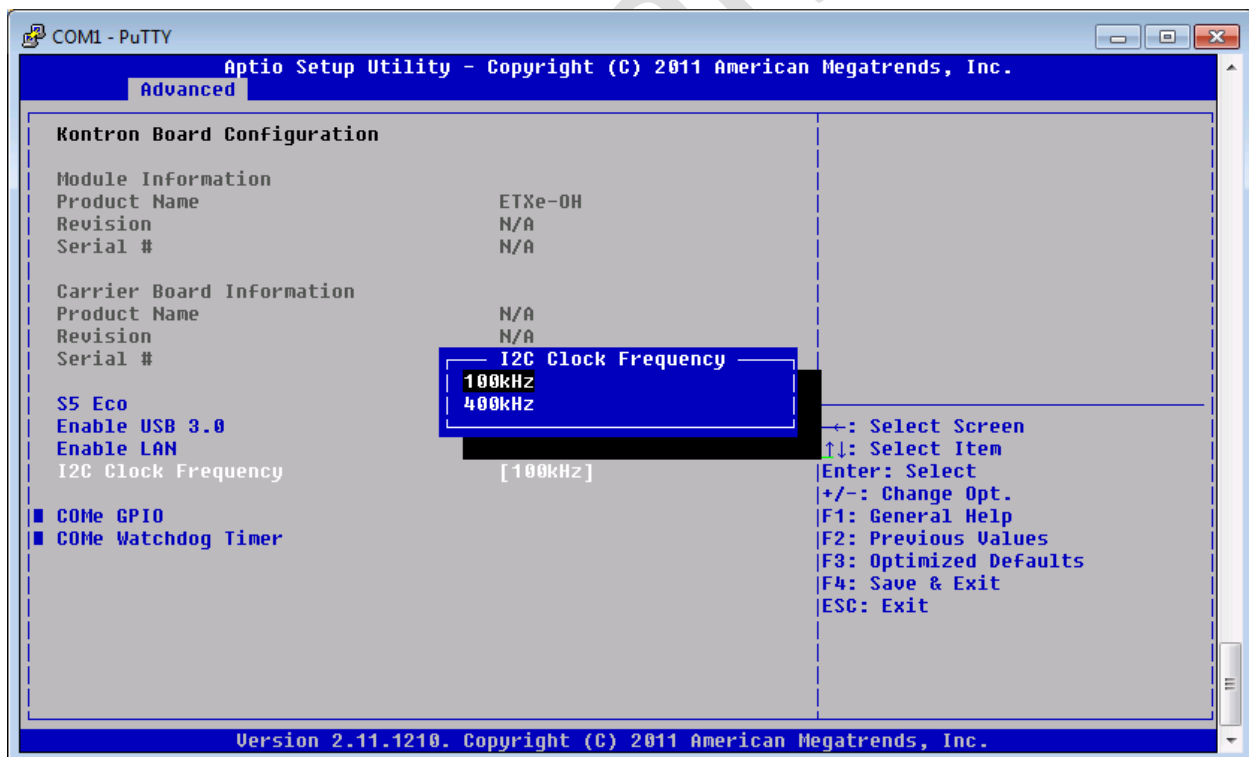
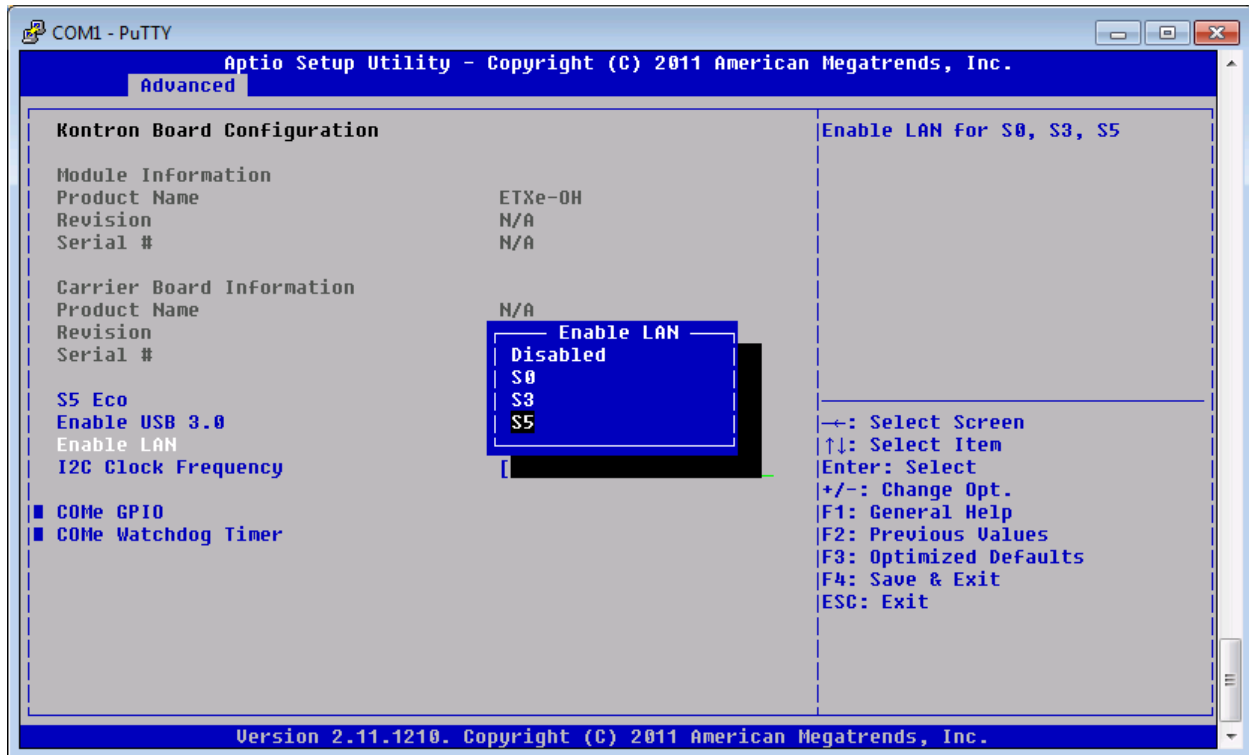

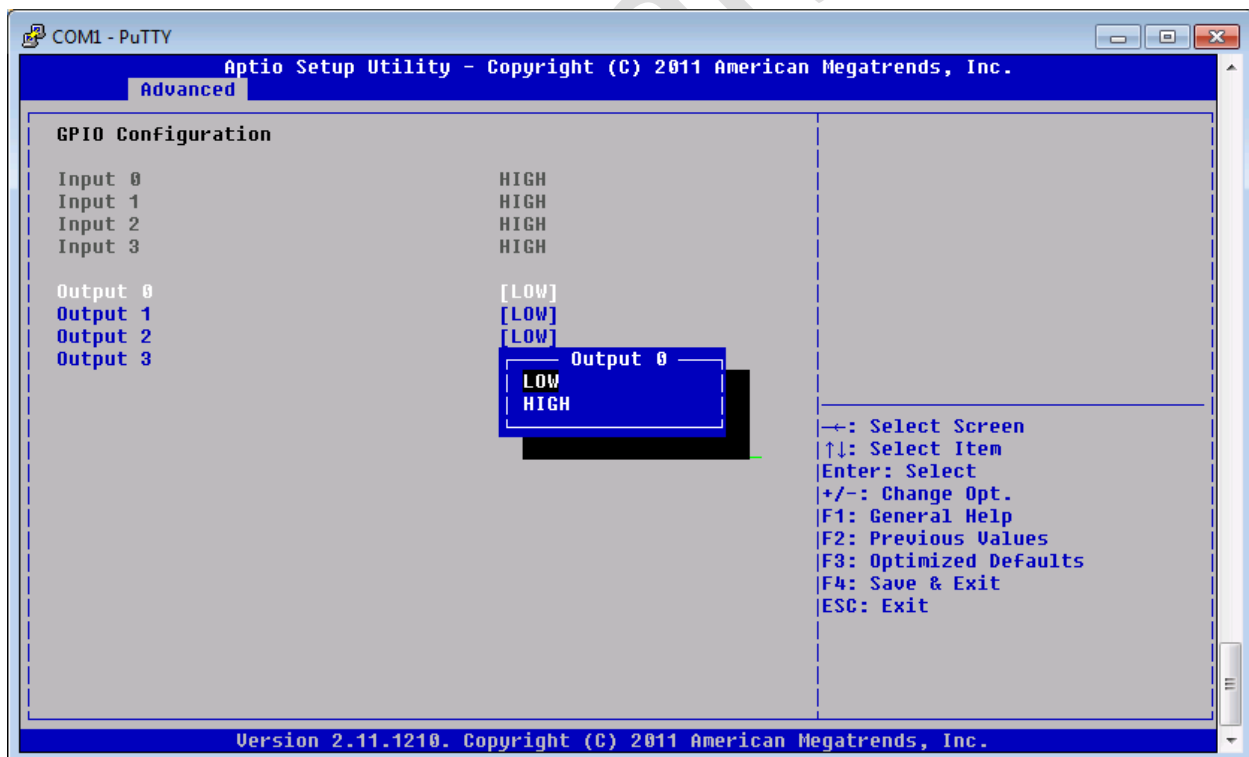
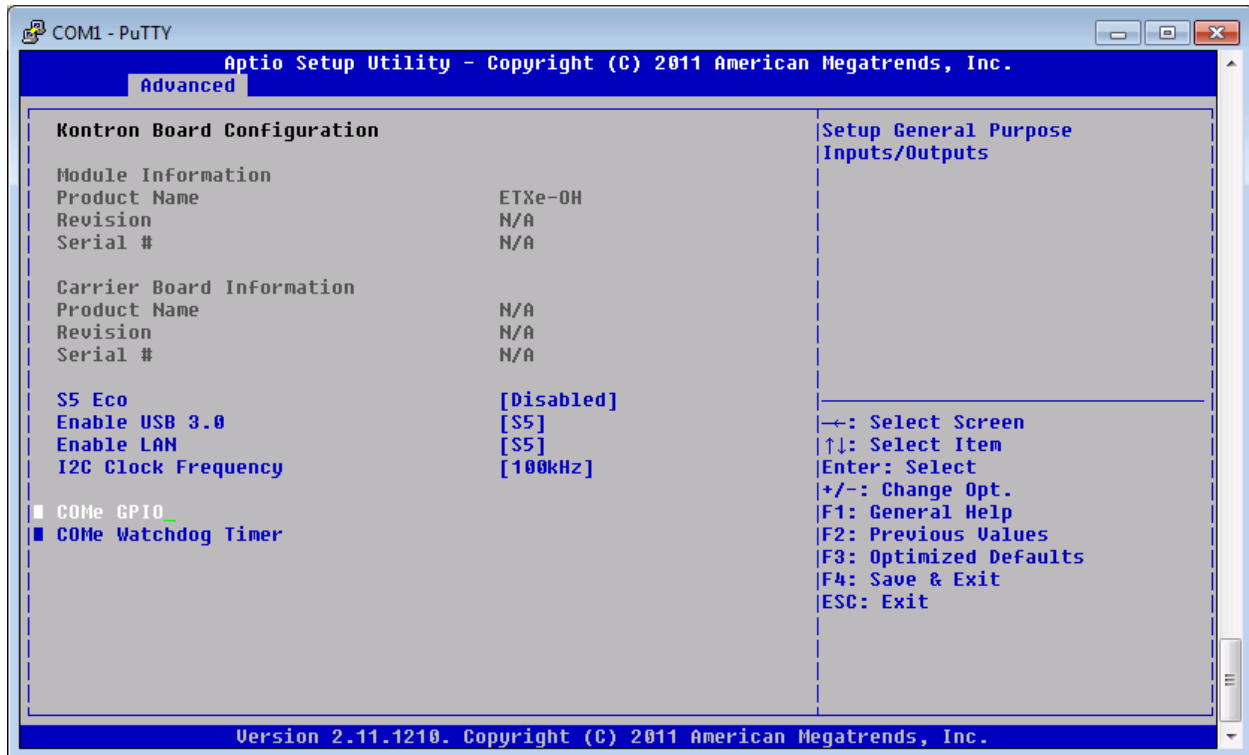

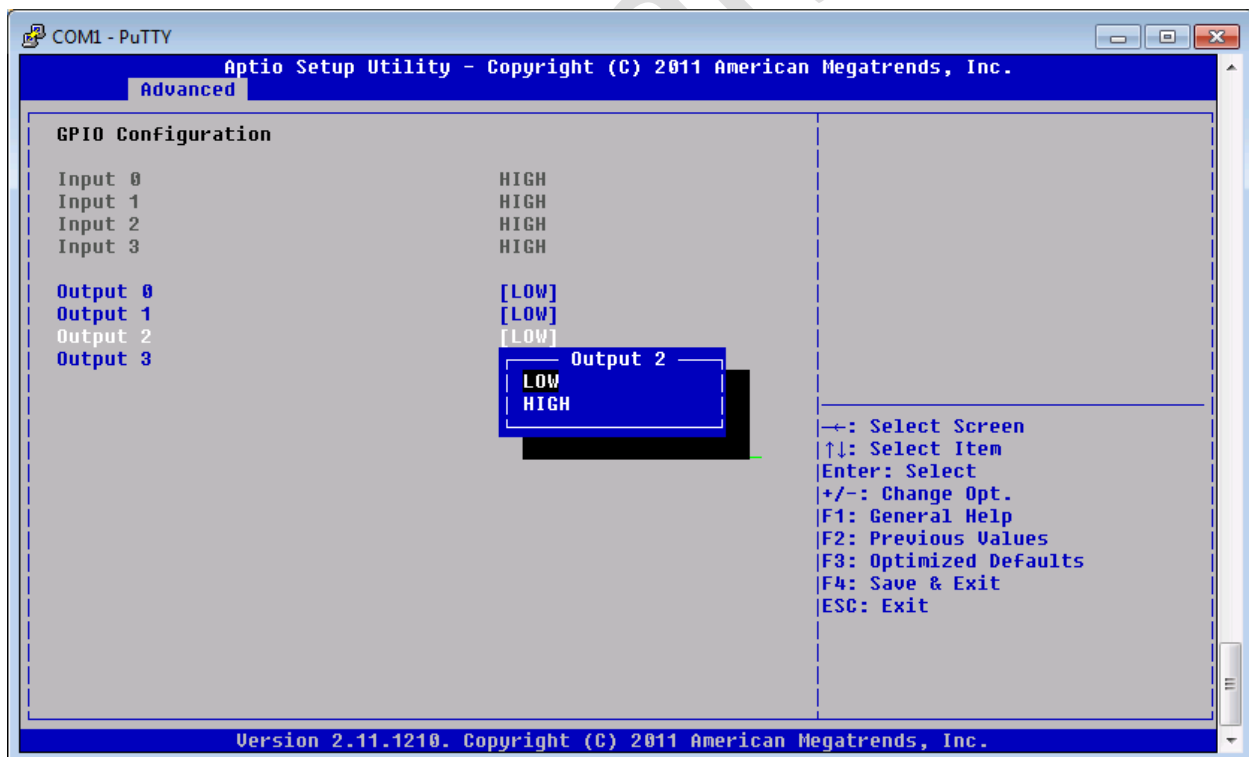
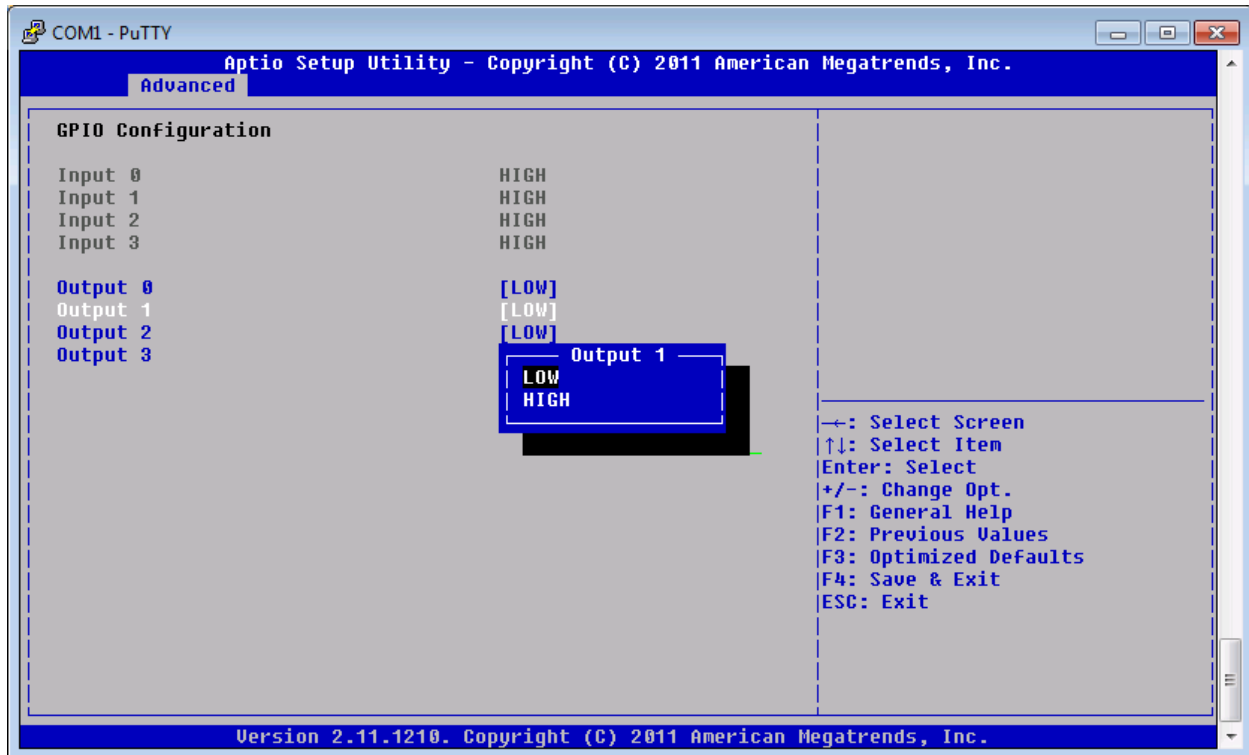

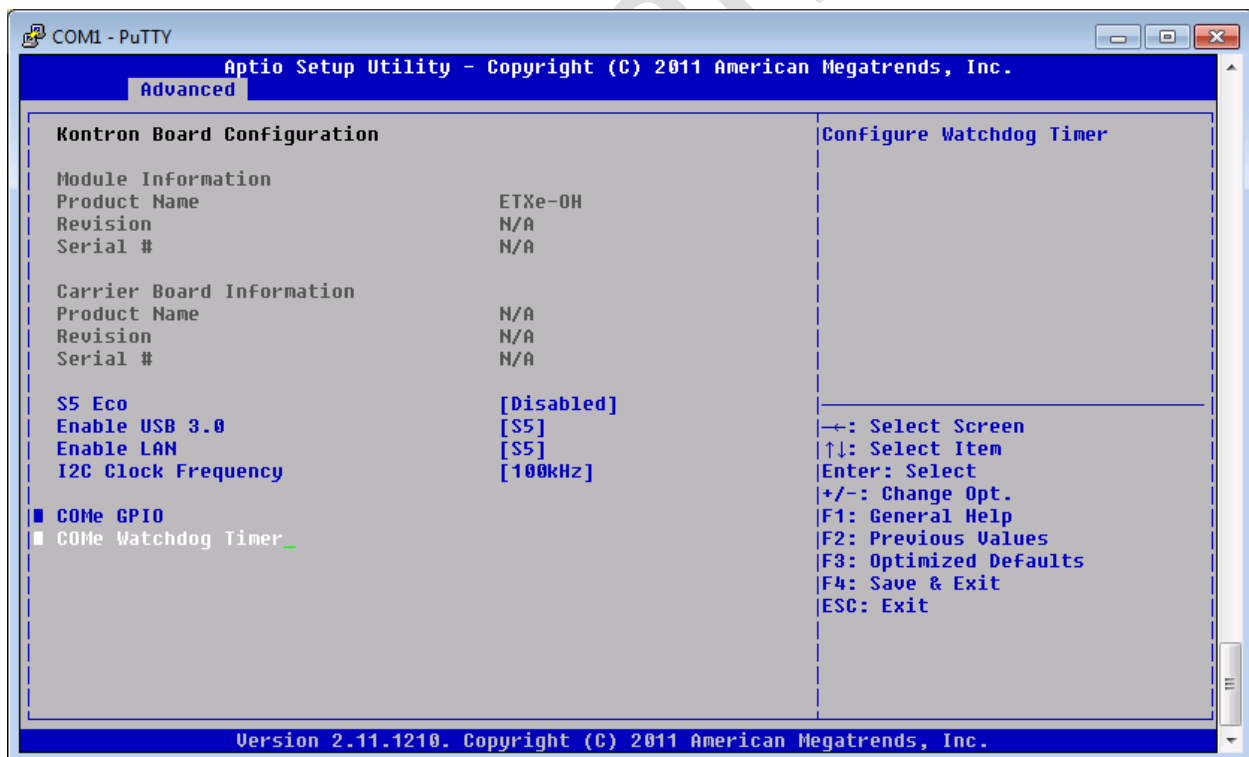
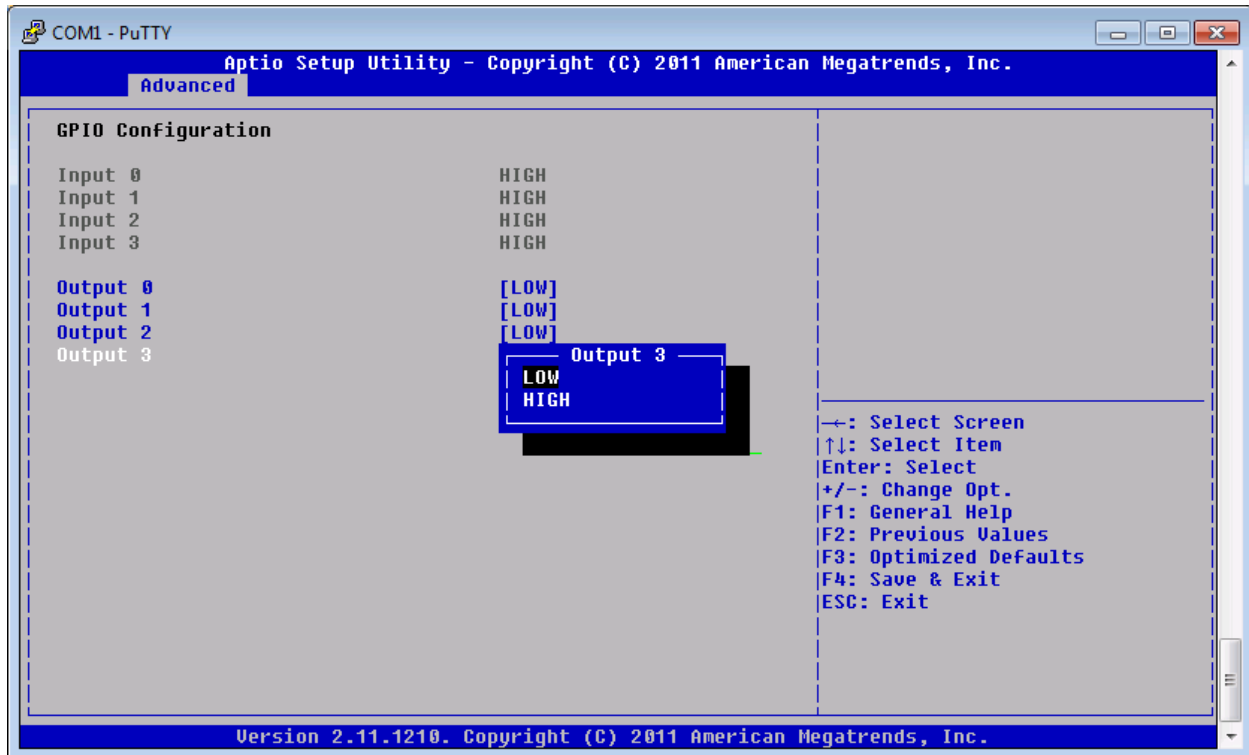

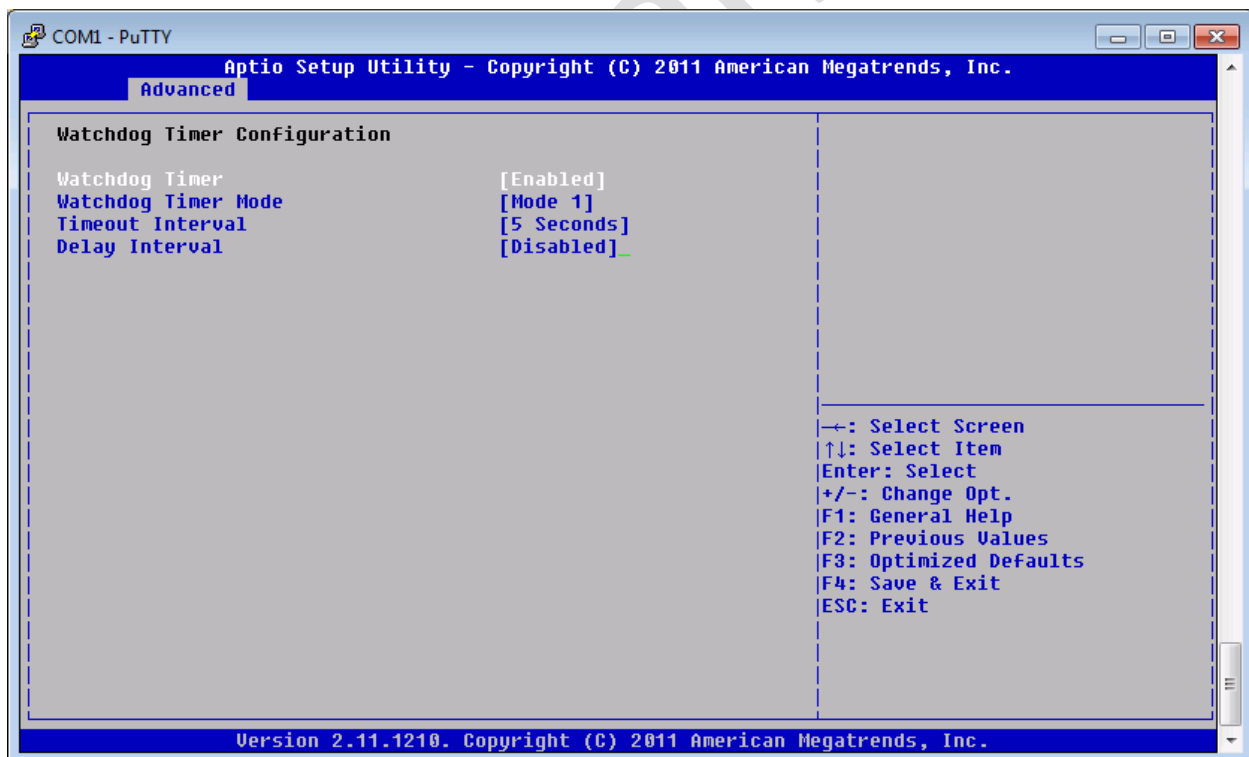
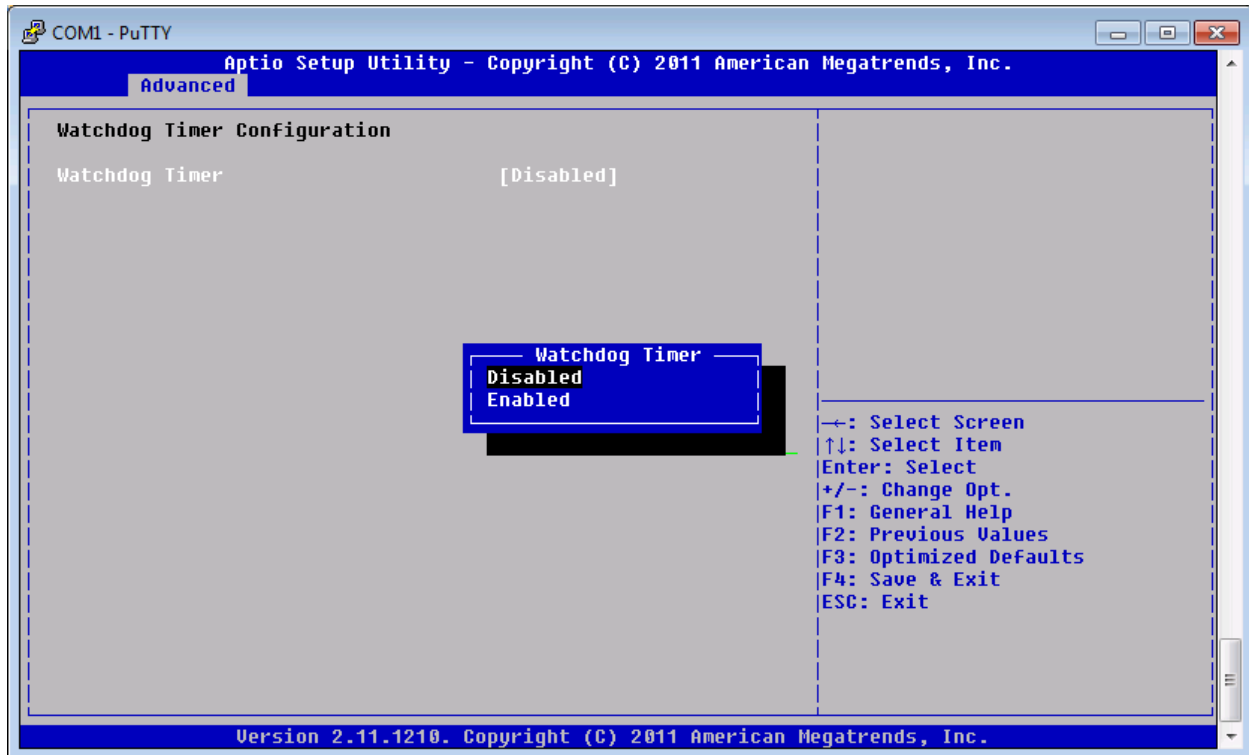

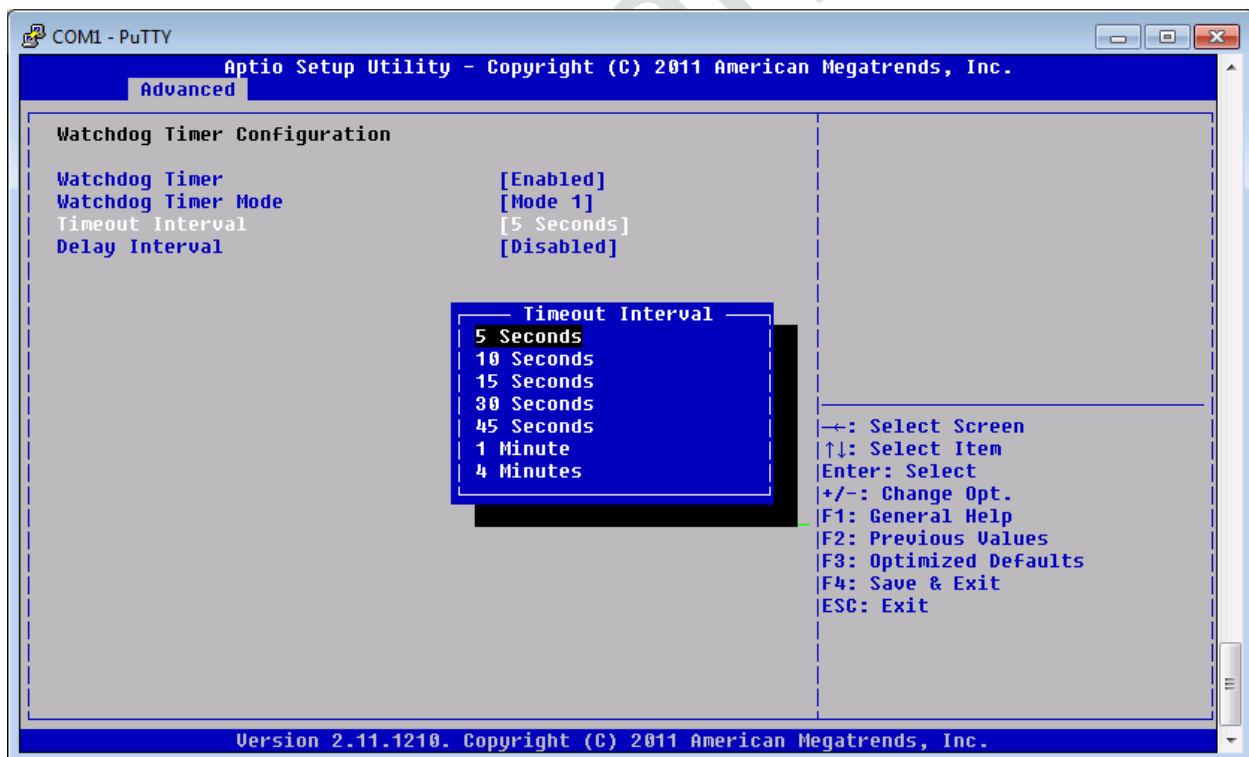
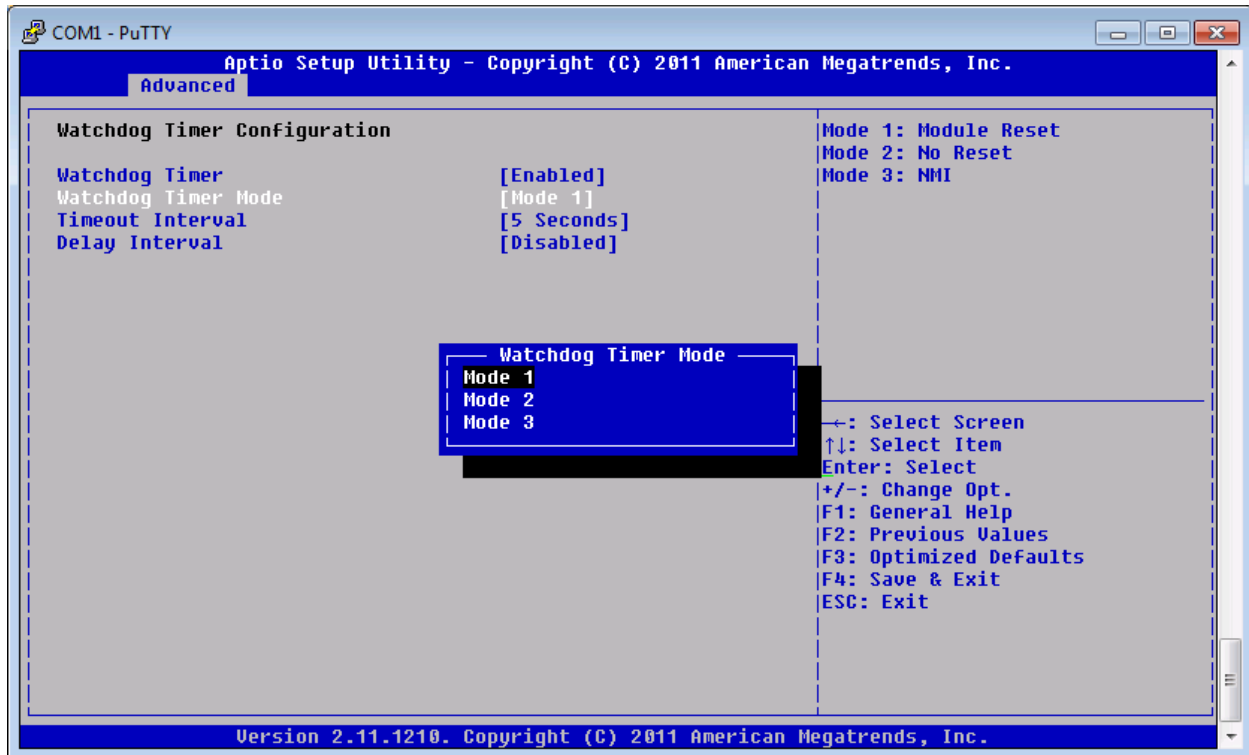

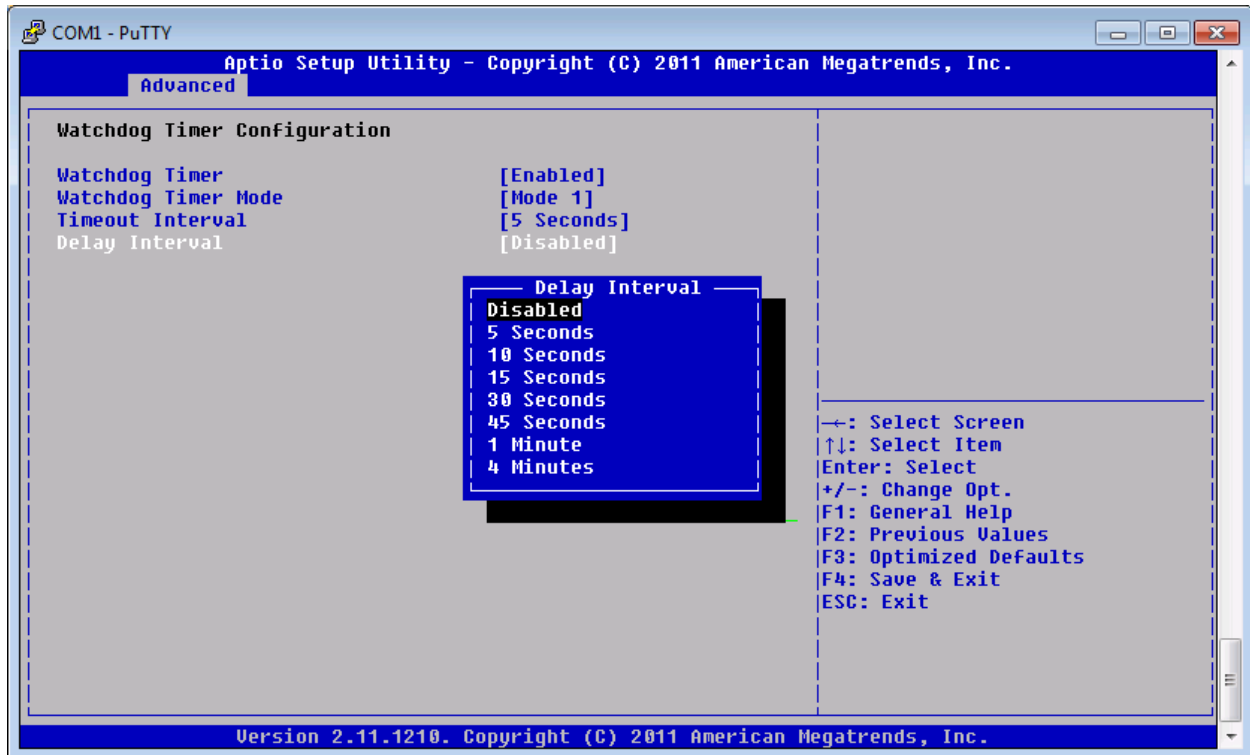

8.3.3 Chipset

North Bridge

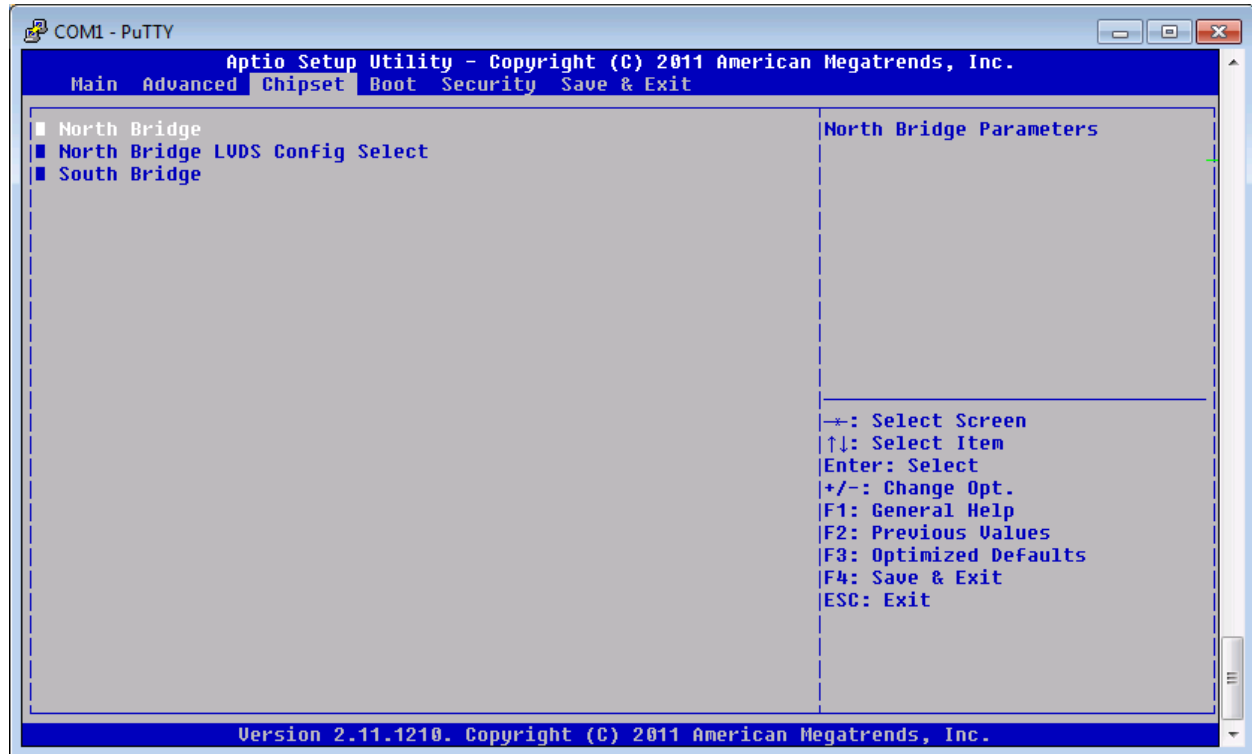

GFX Configuration

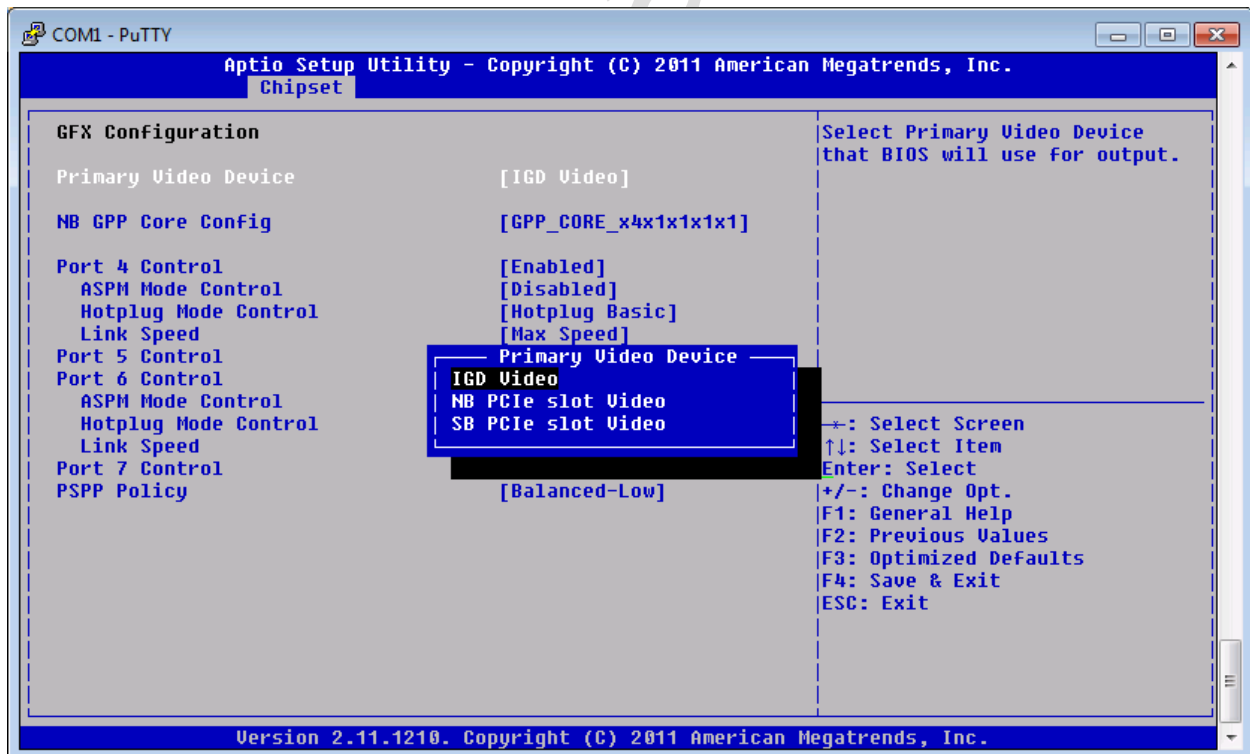
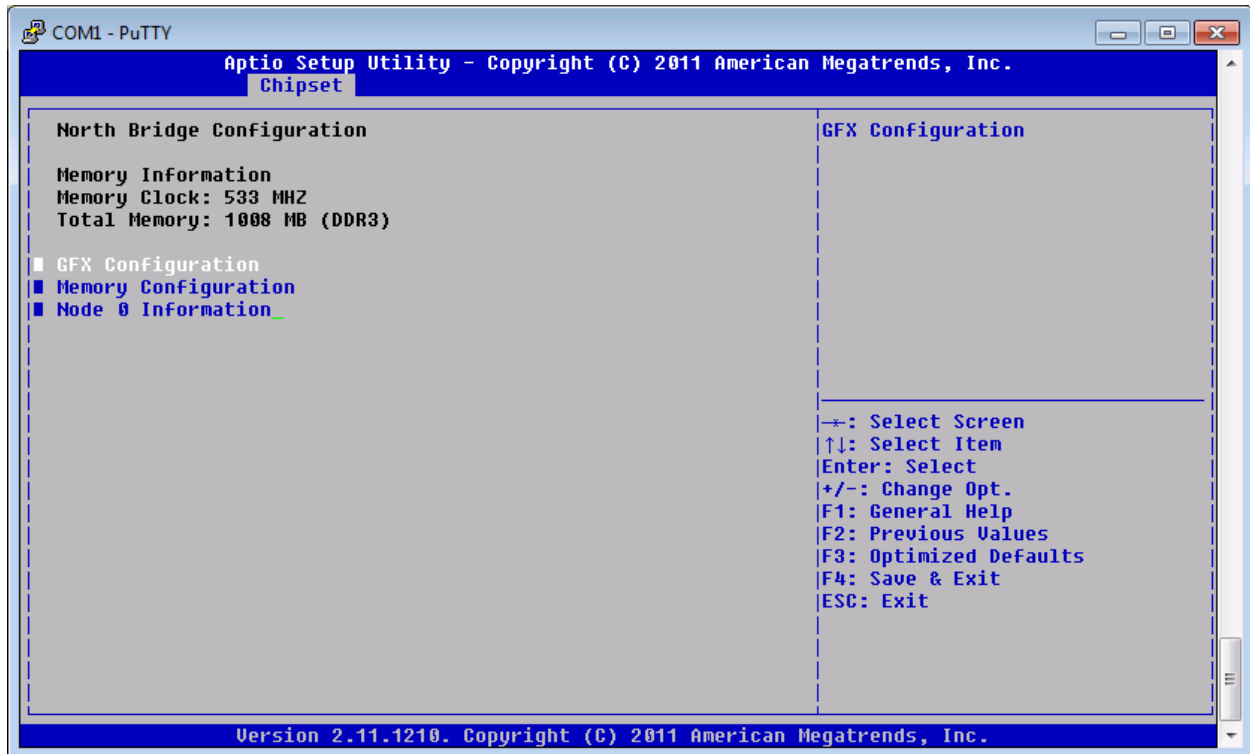

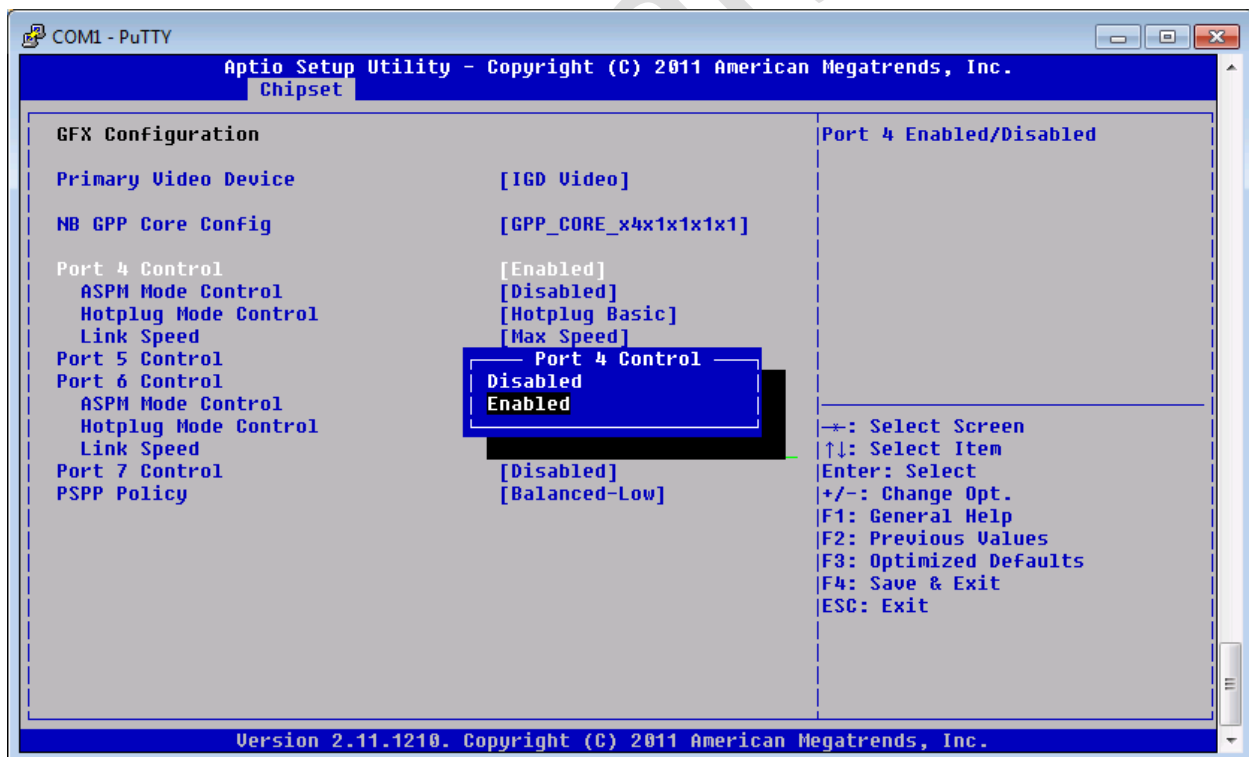
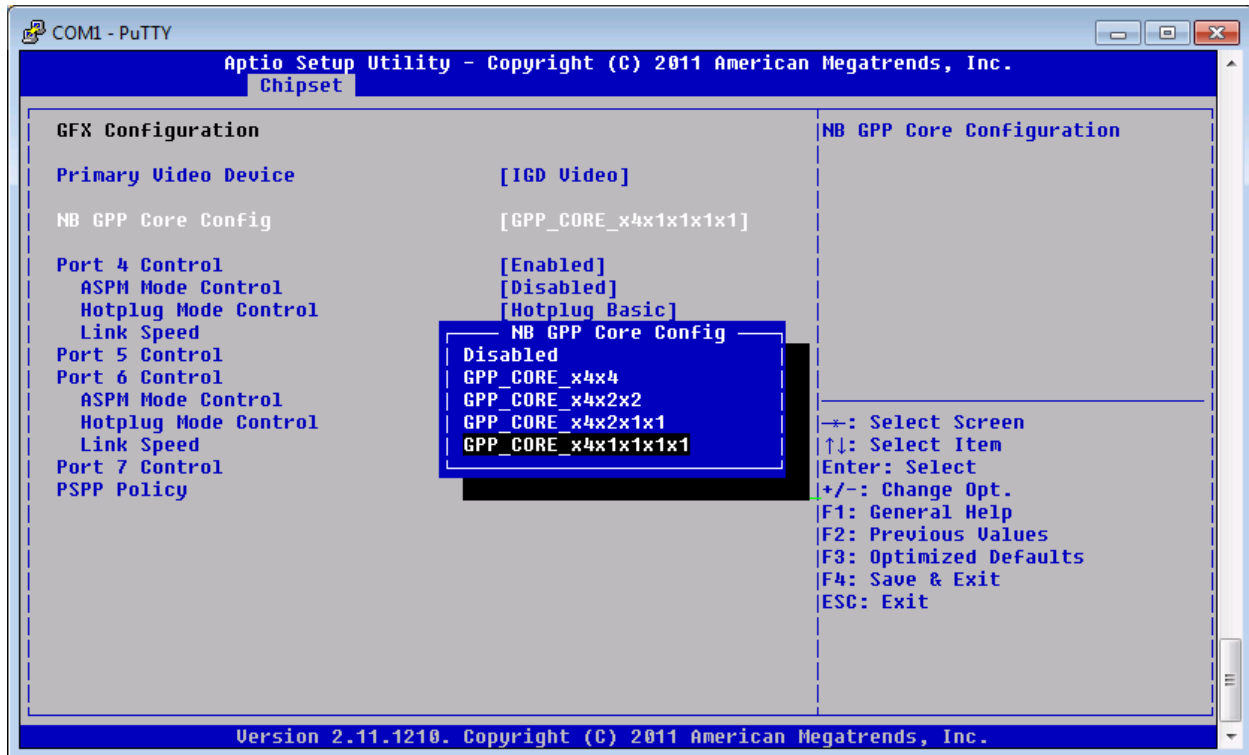

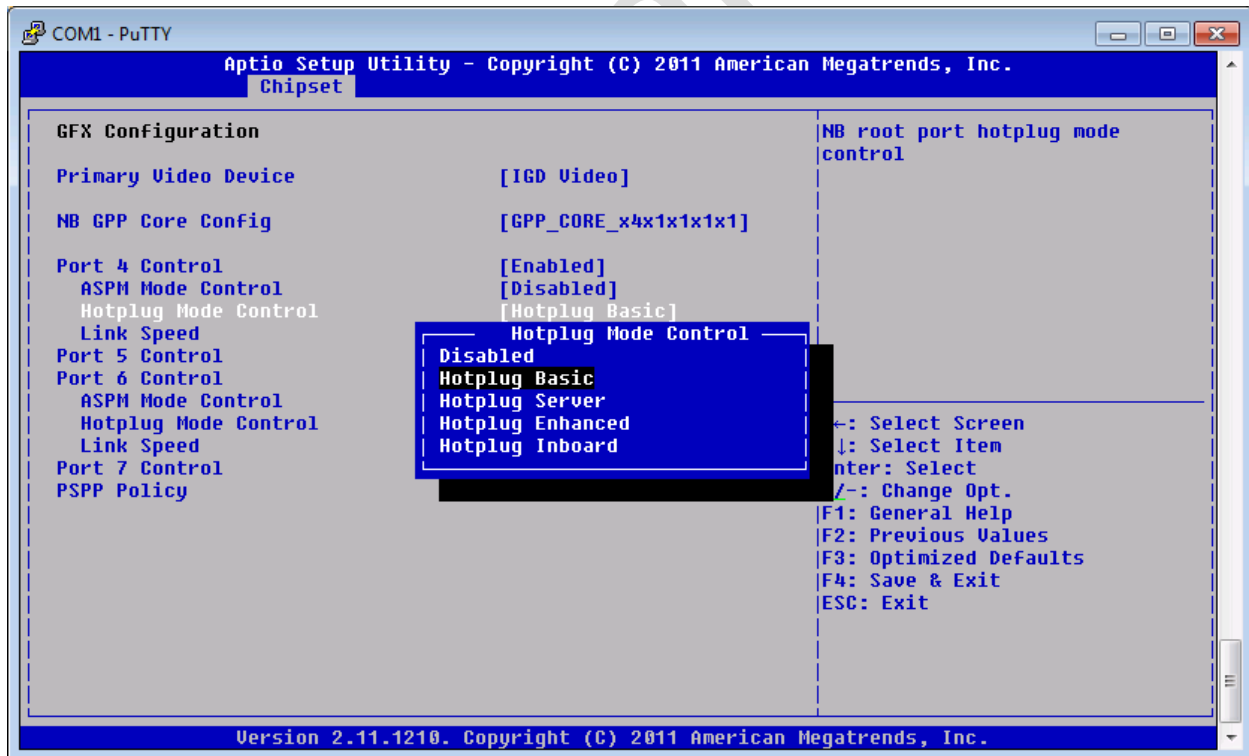
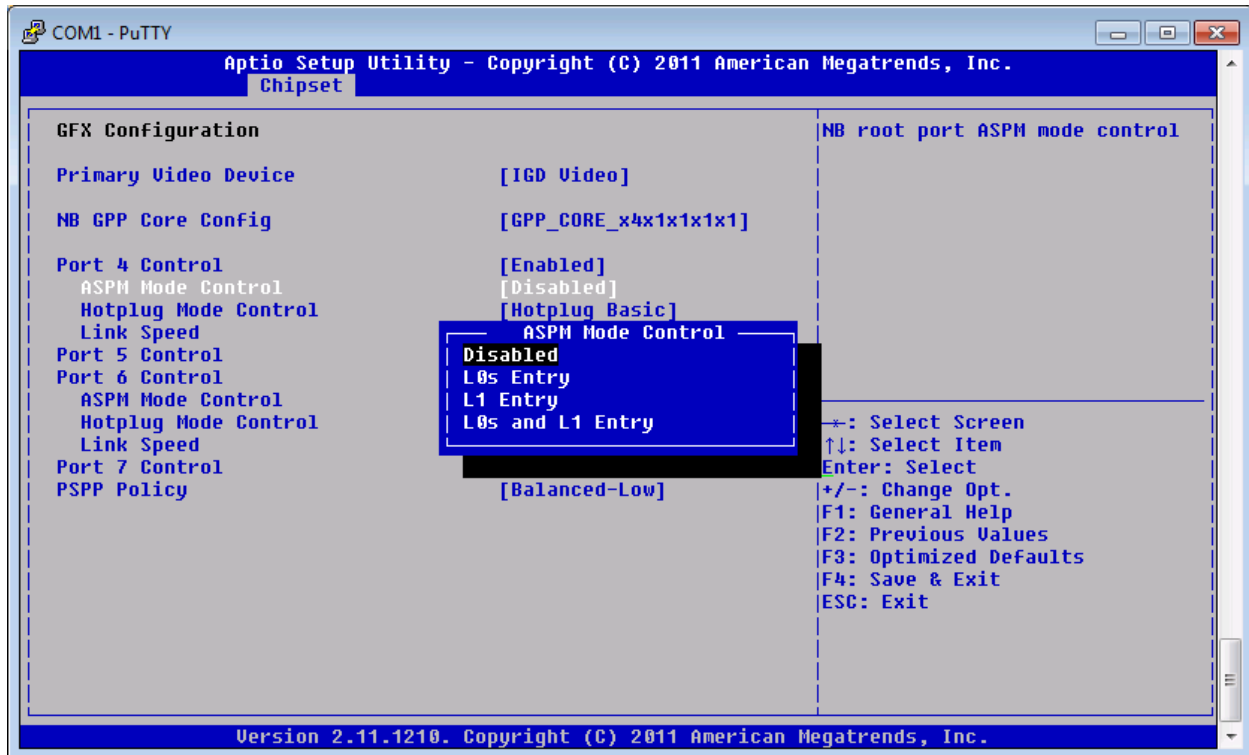

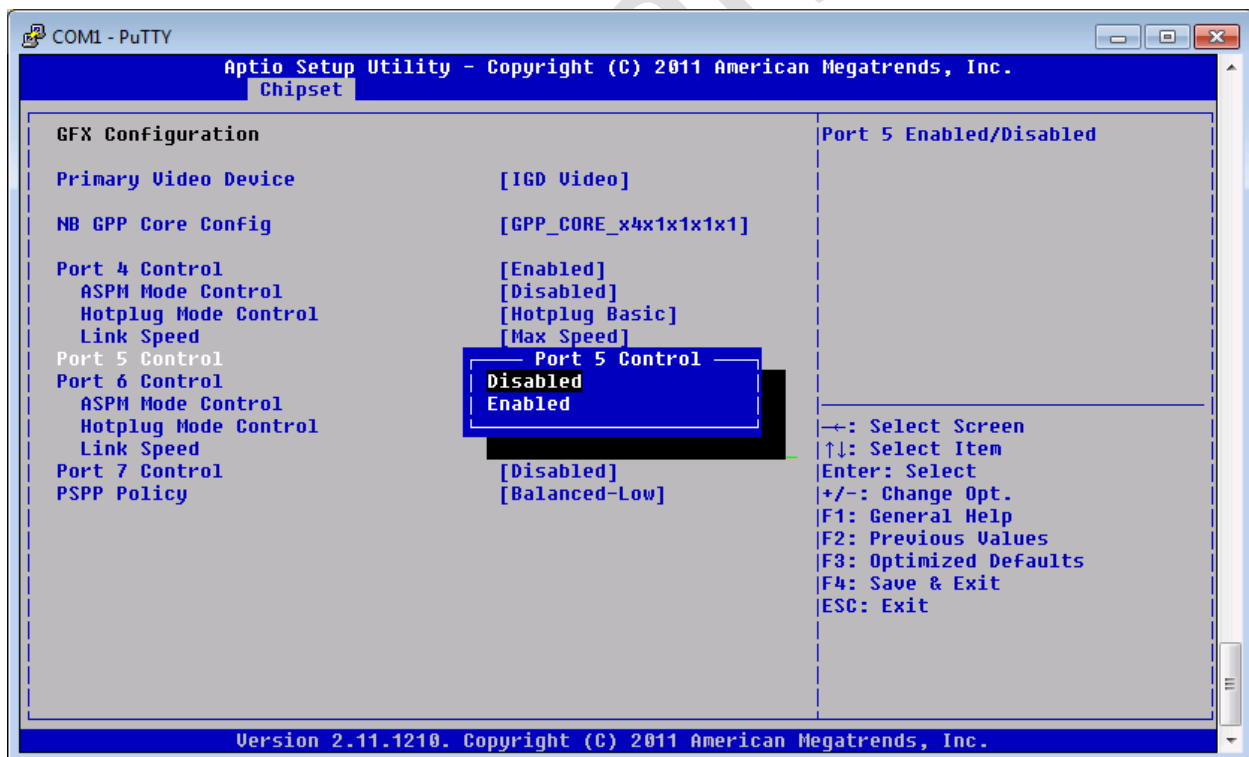
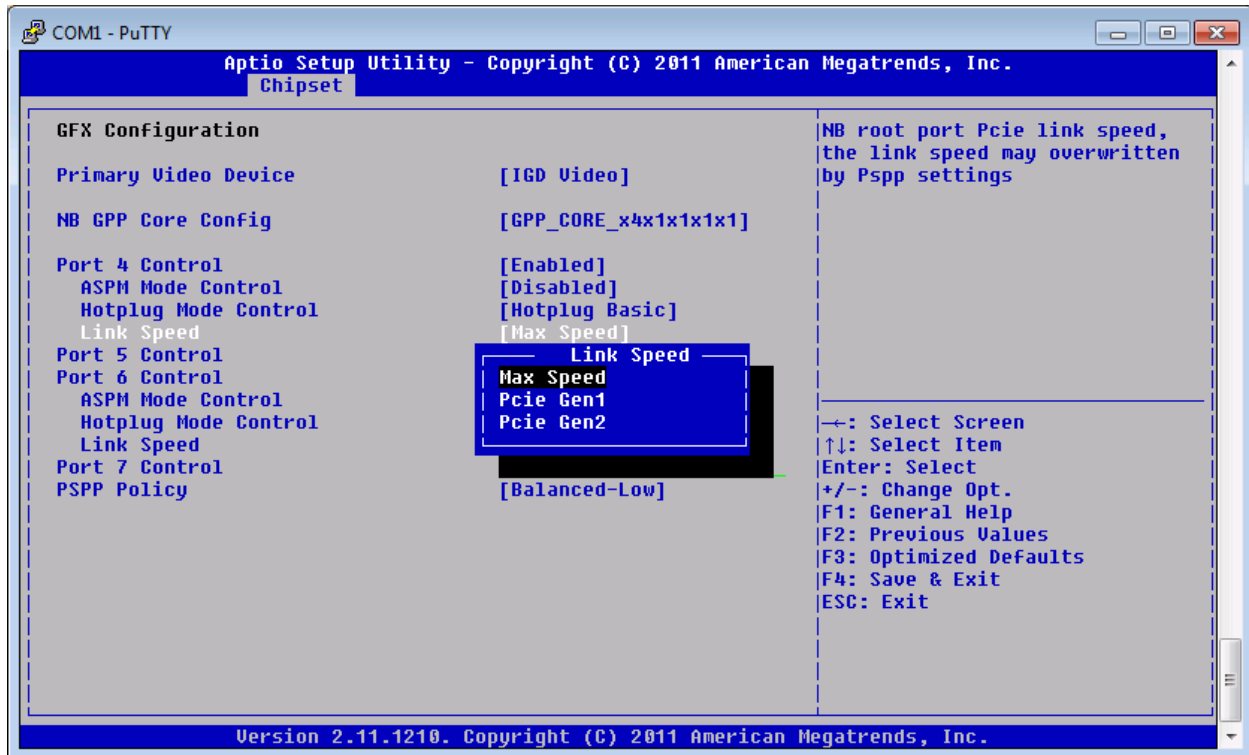

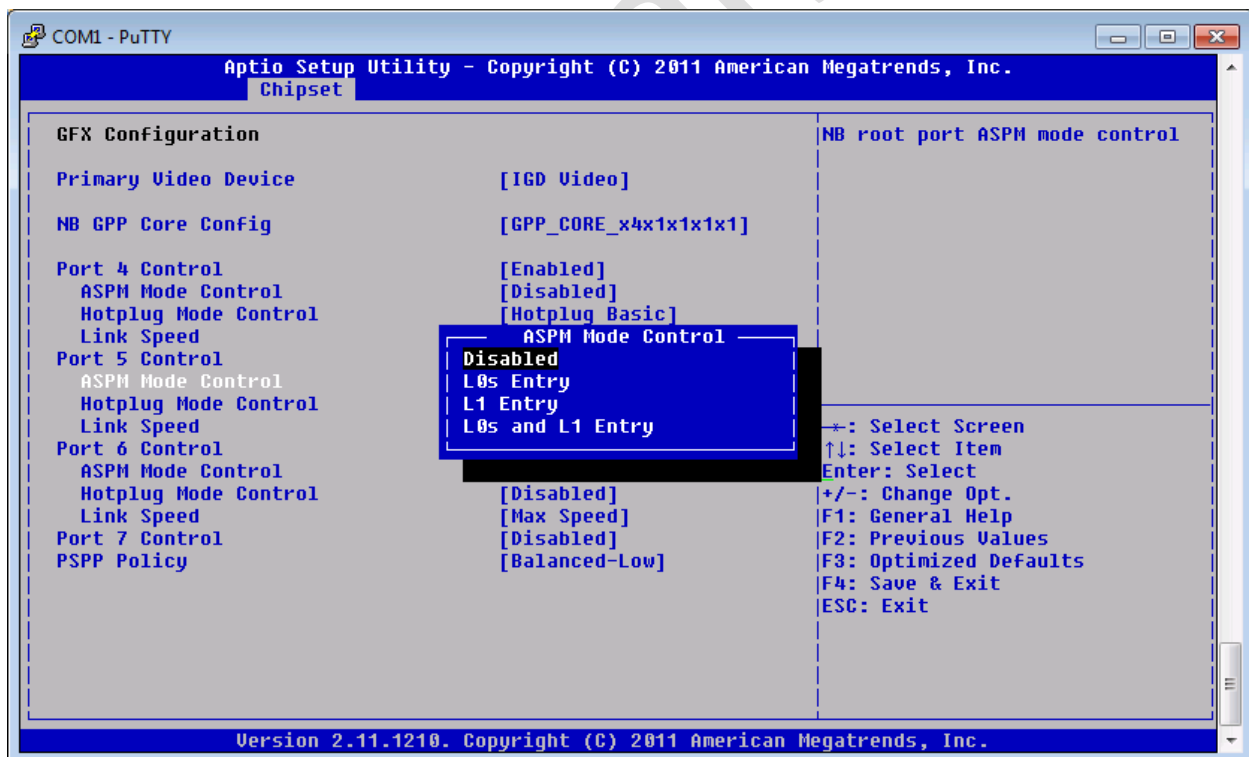
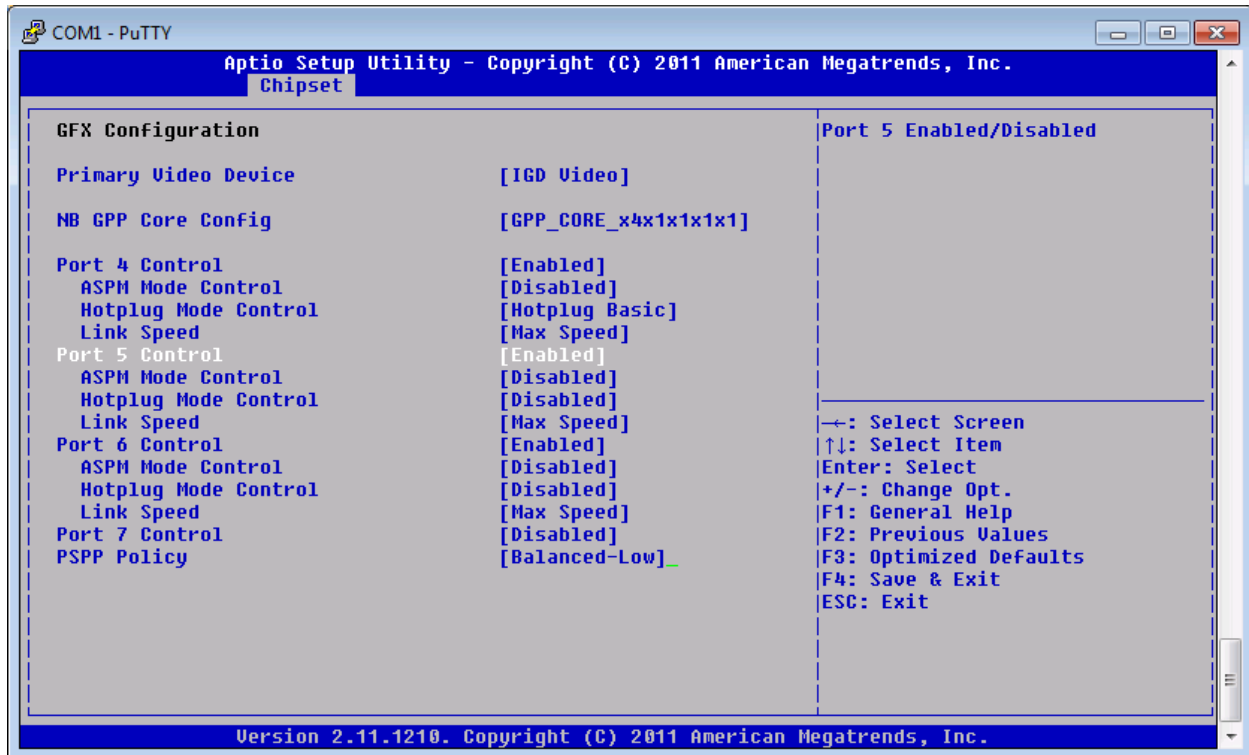

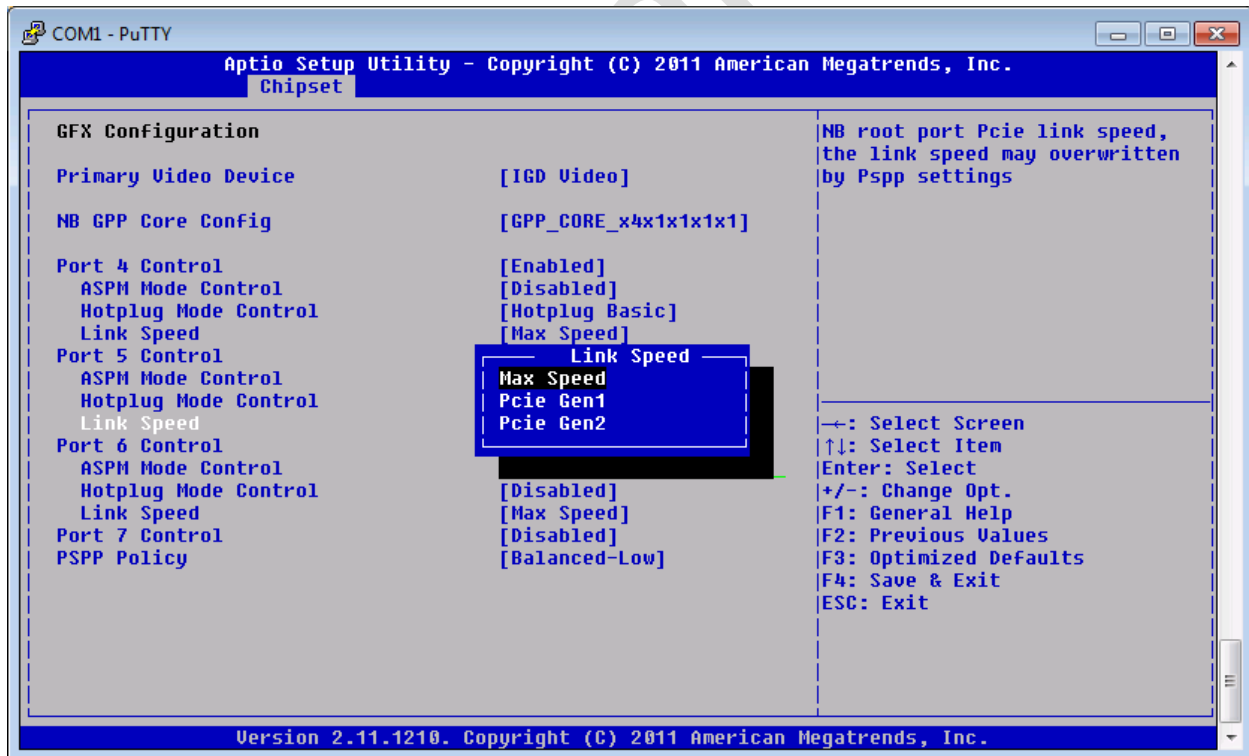
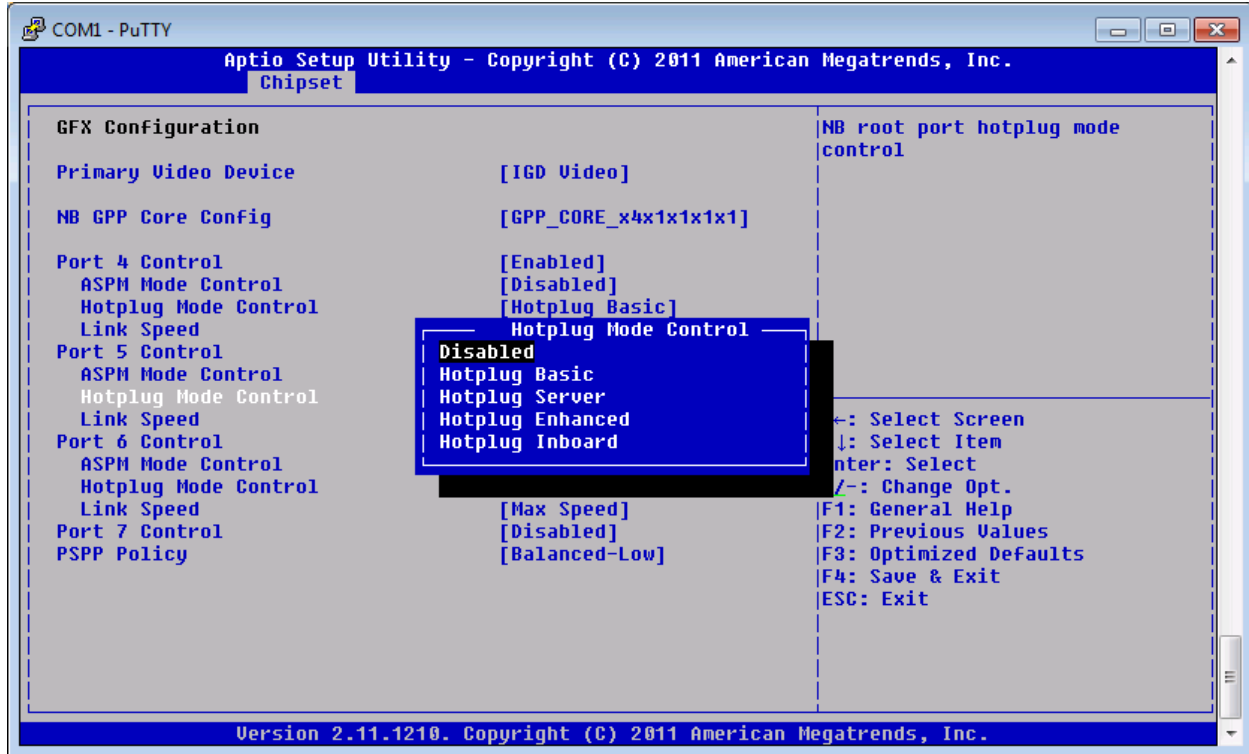

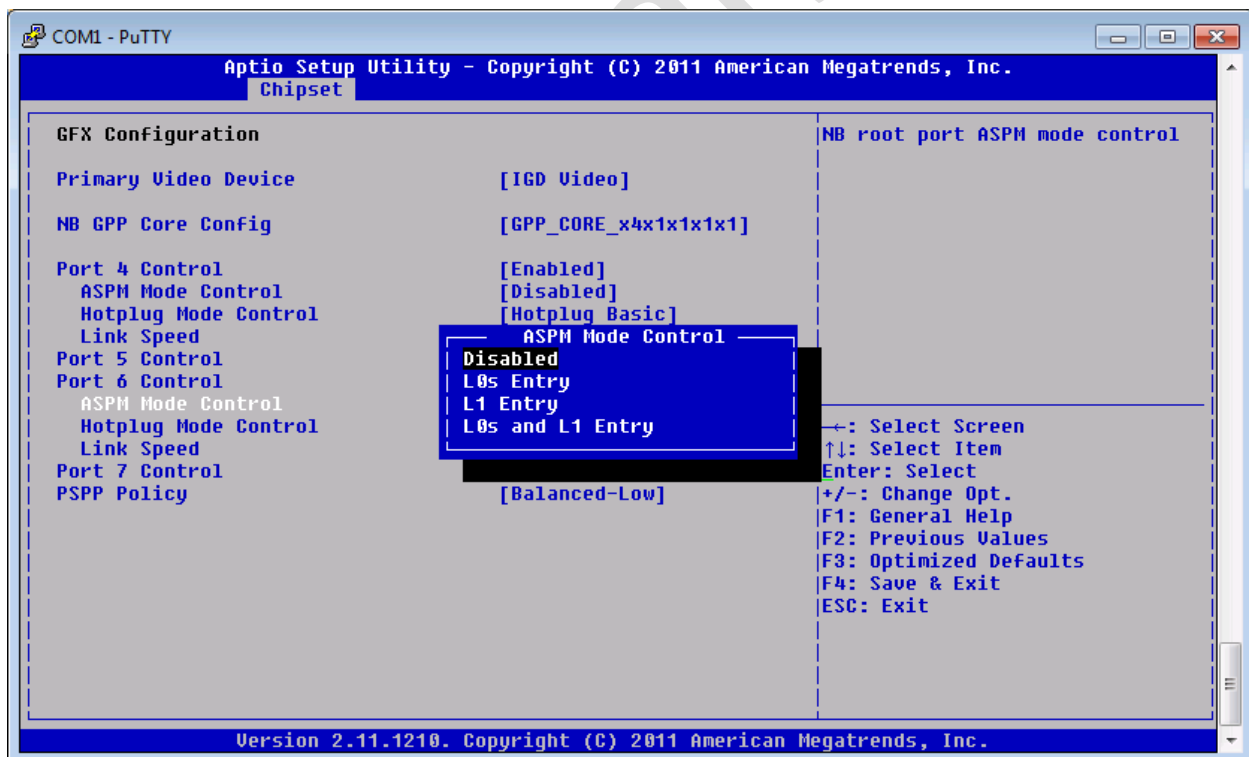
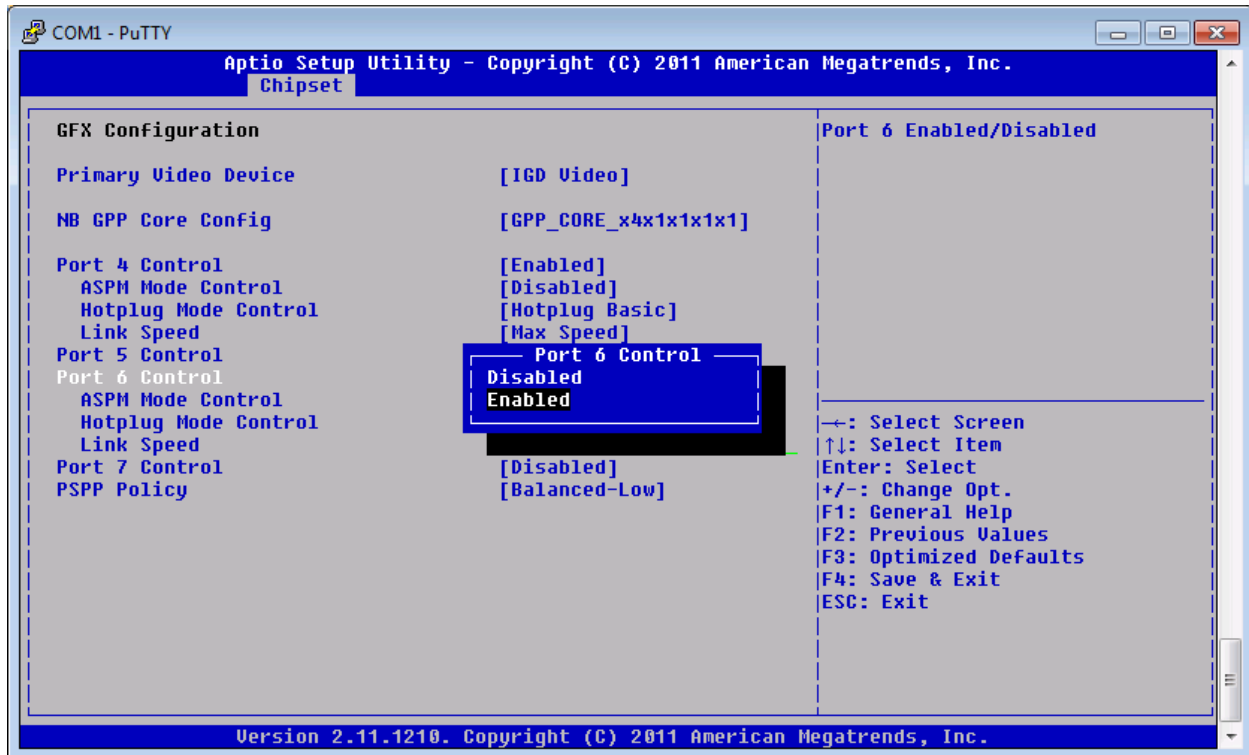

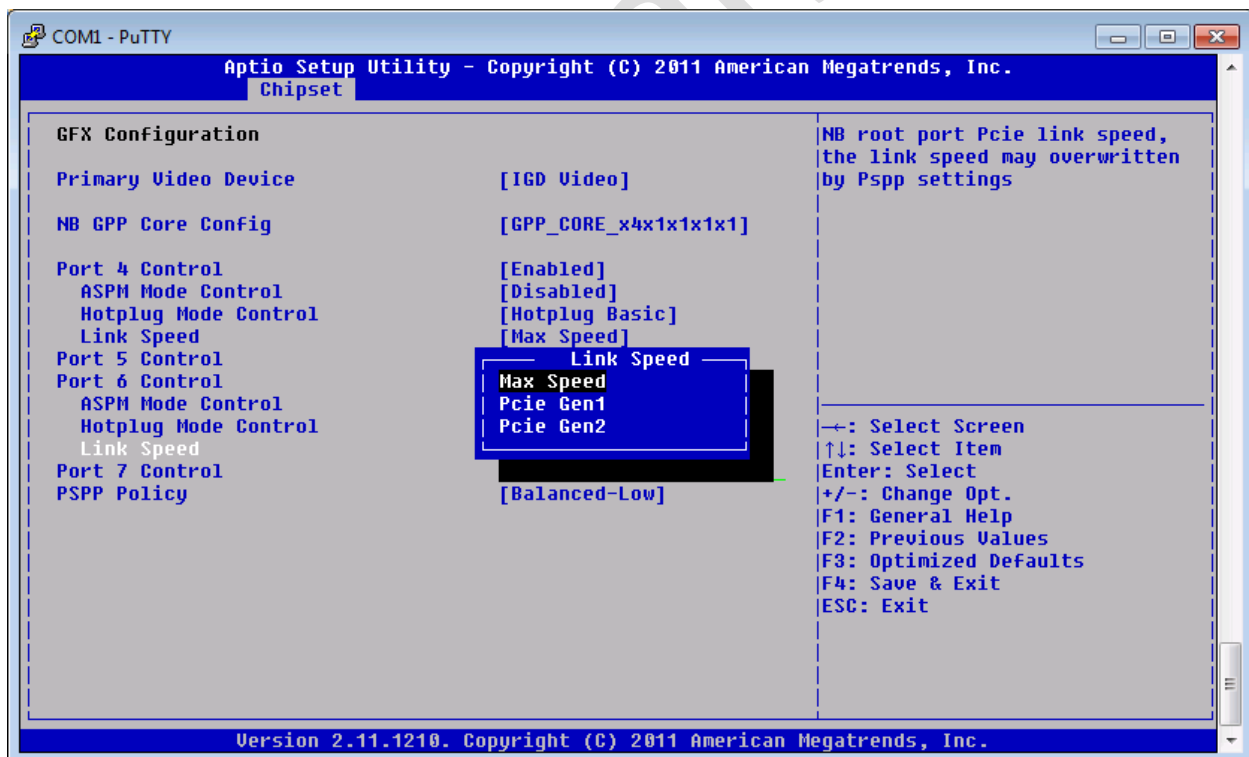
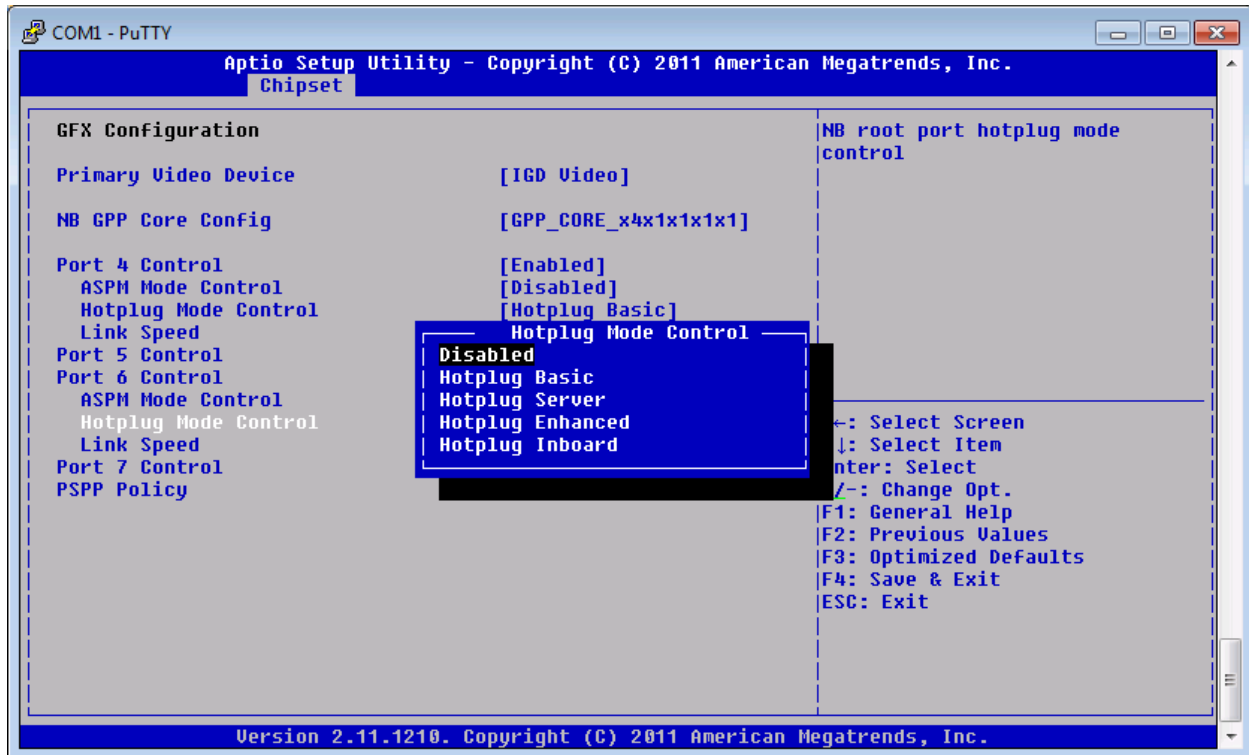

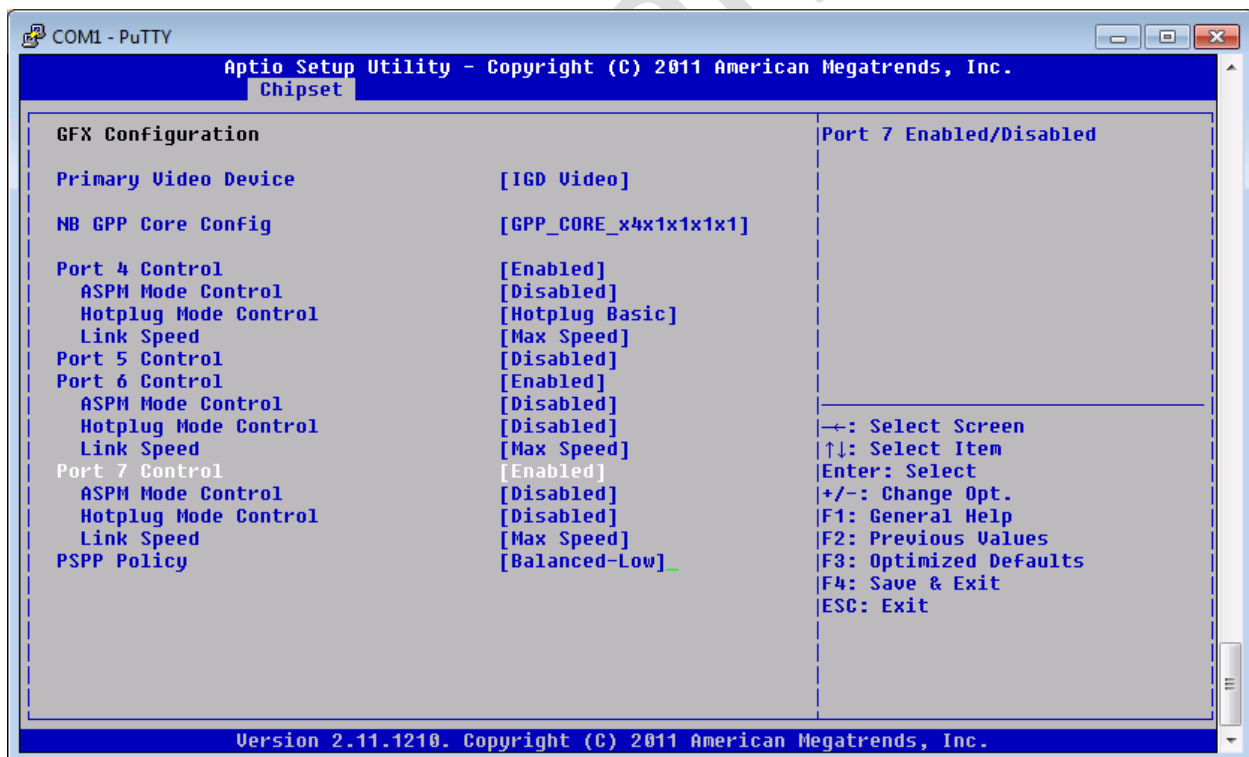
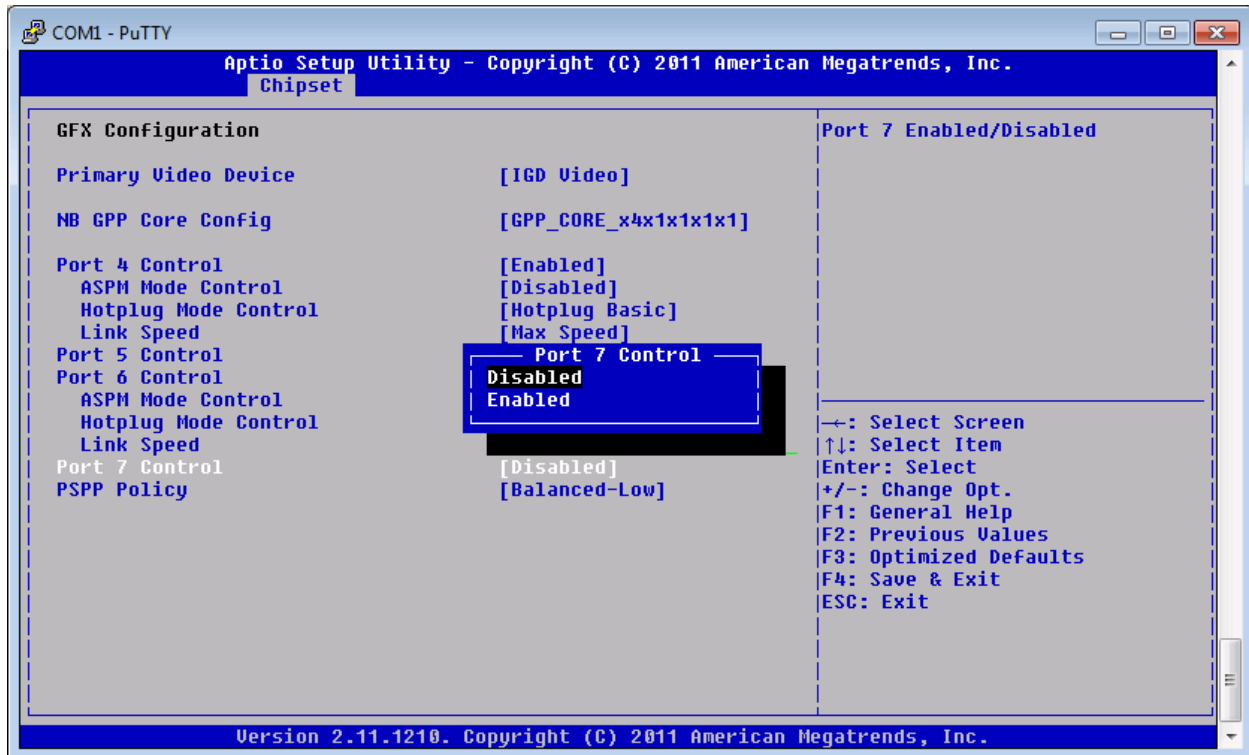

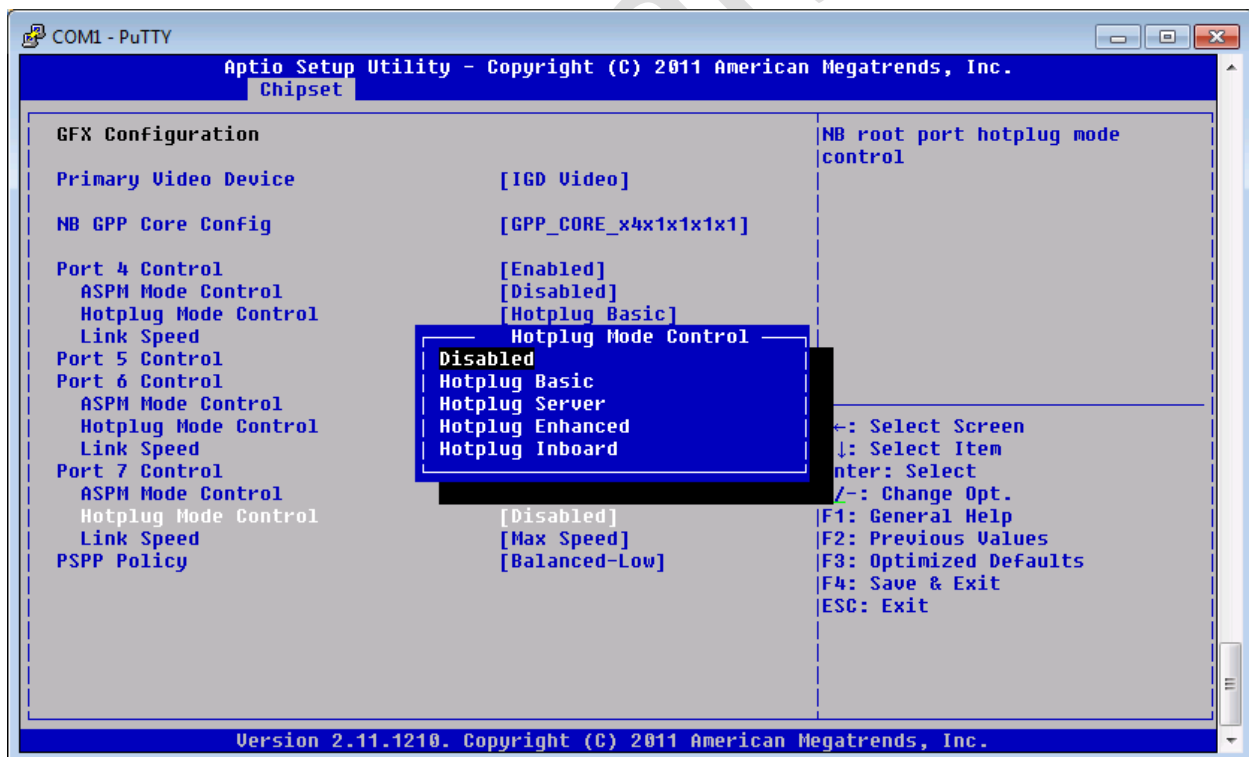
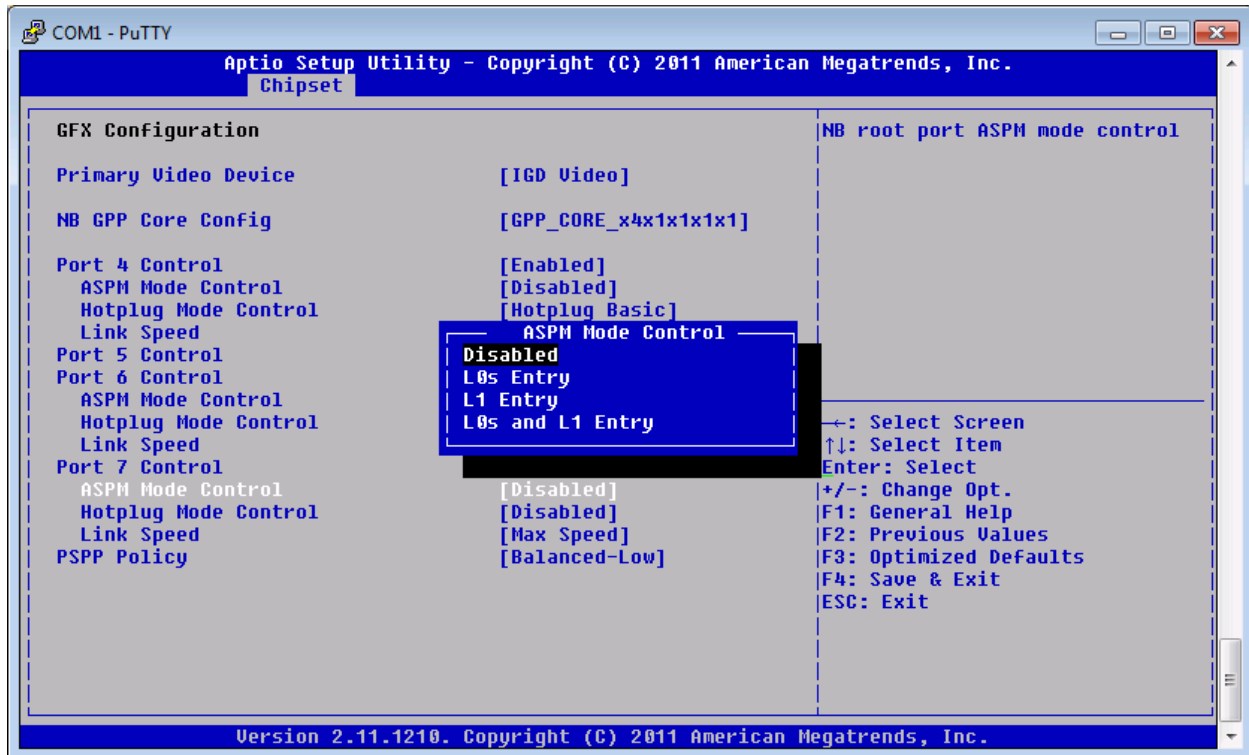

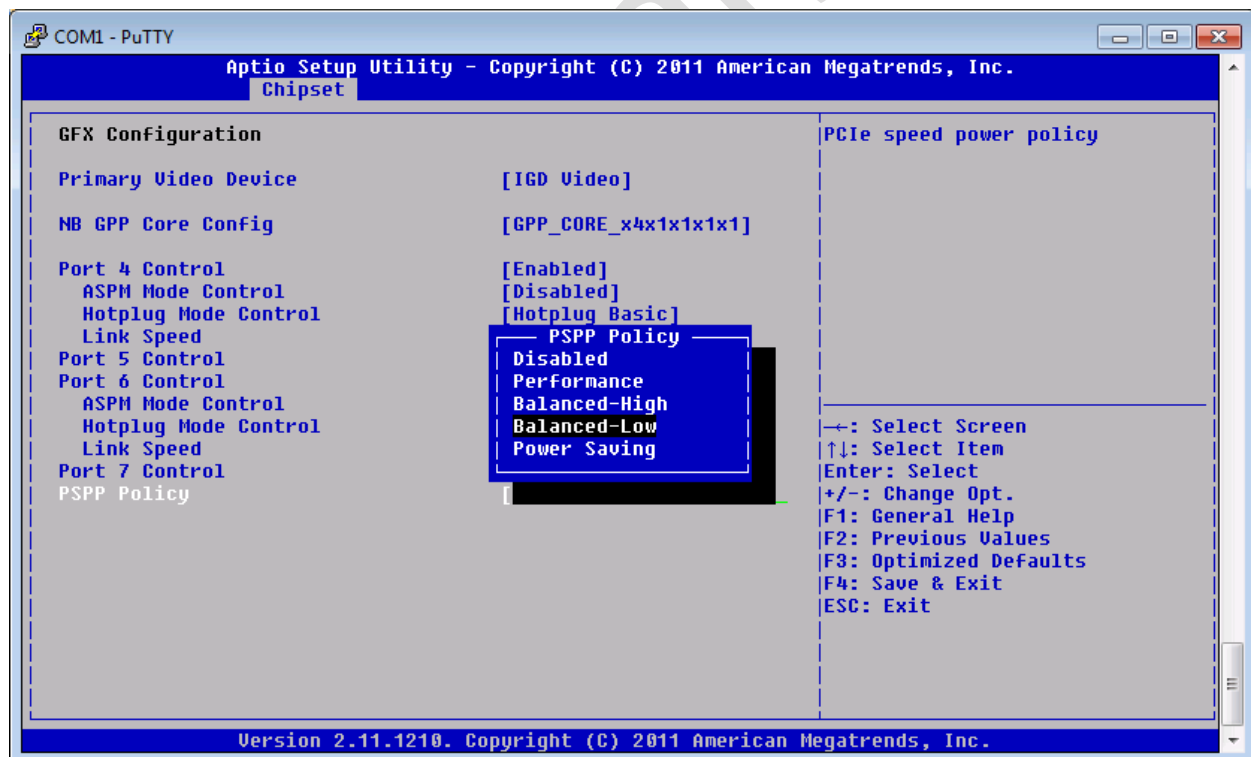
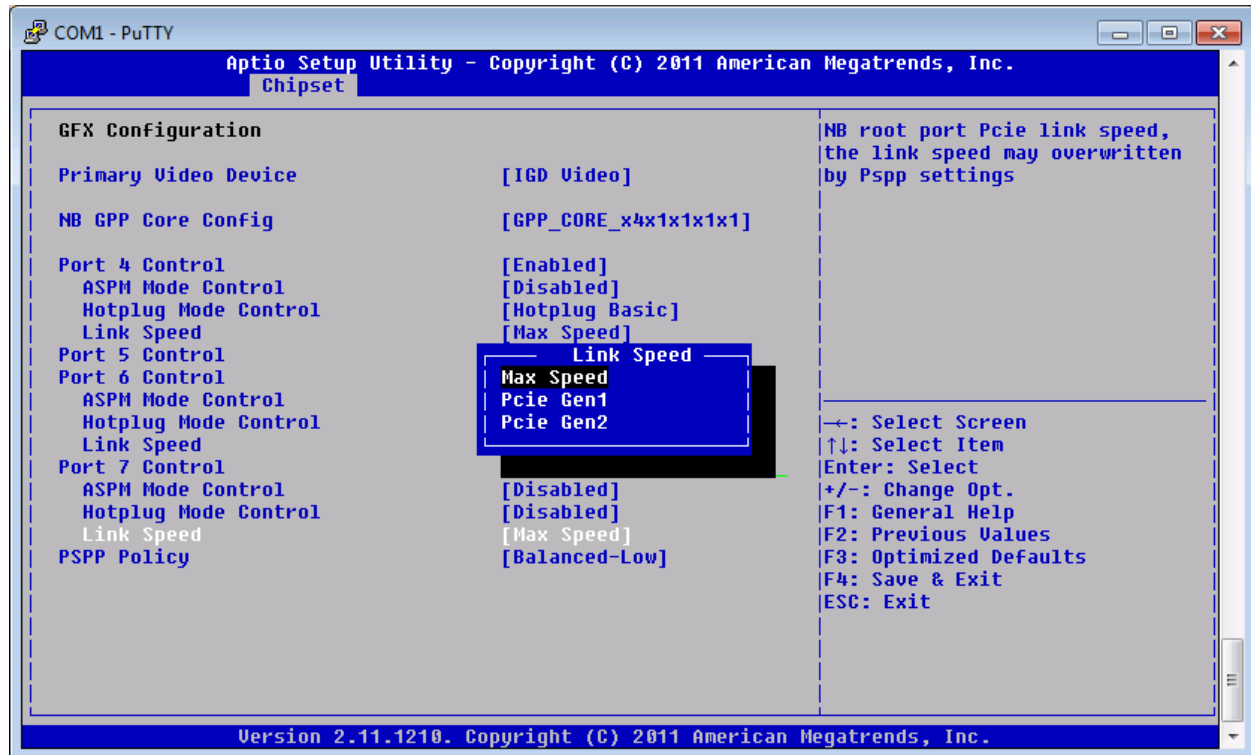

Memory Configuration

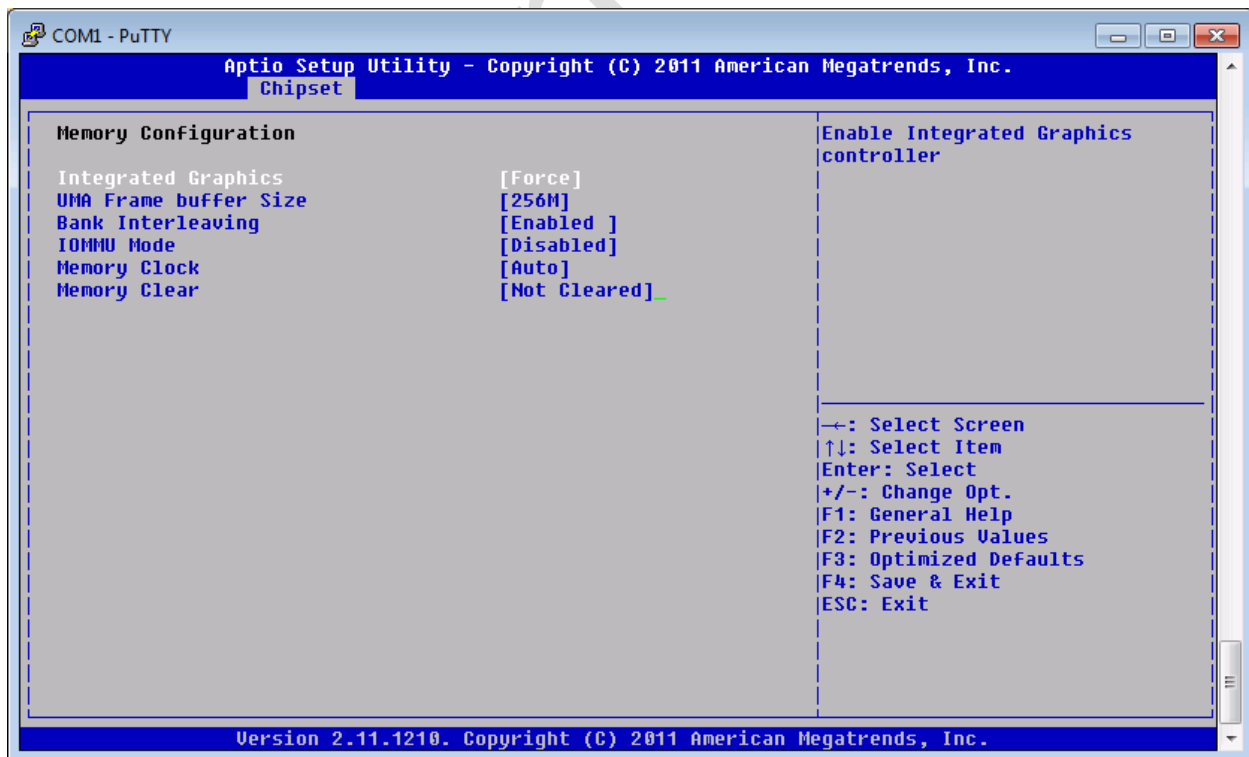
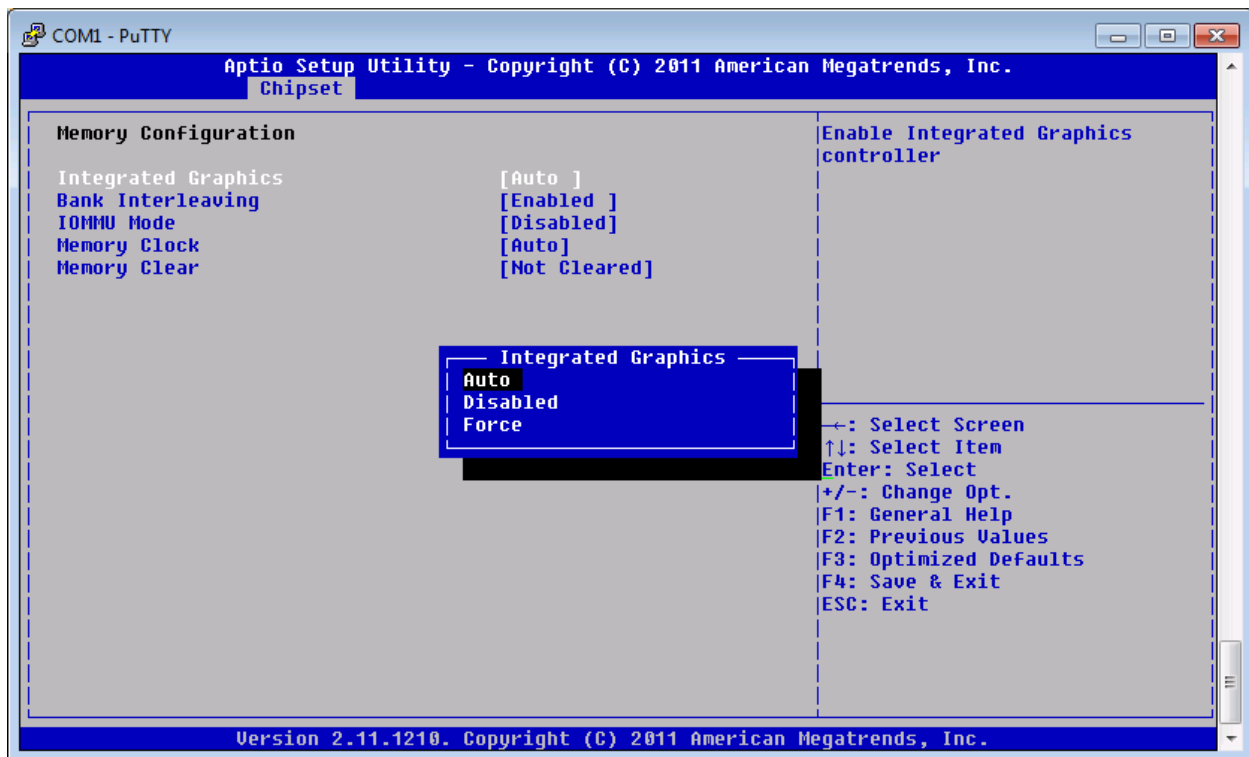

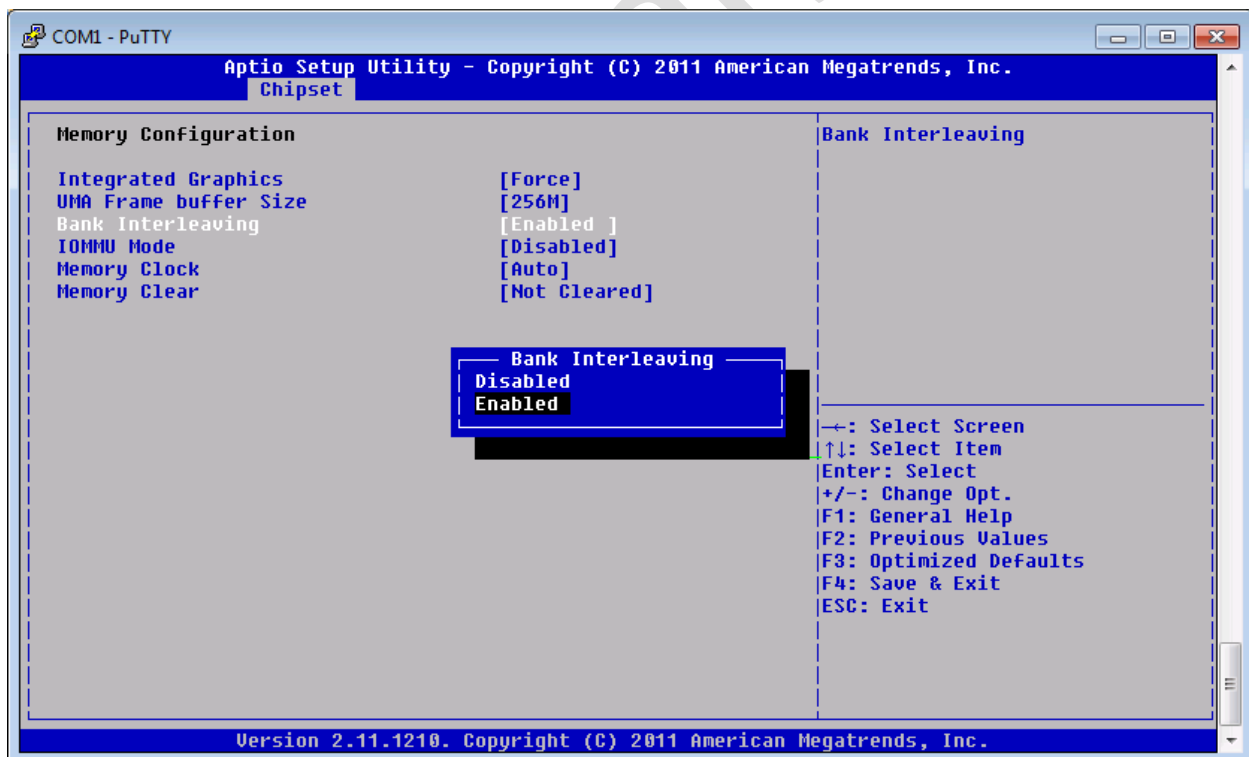
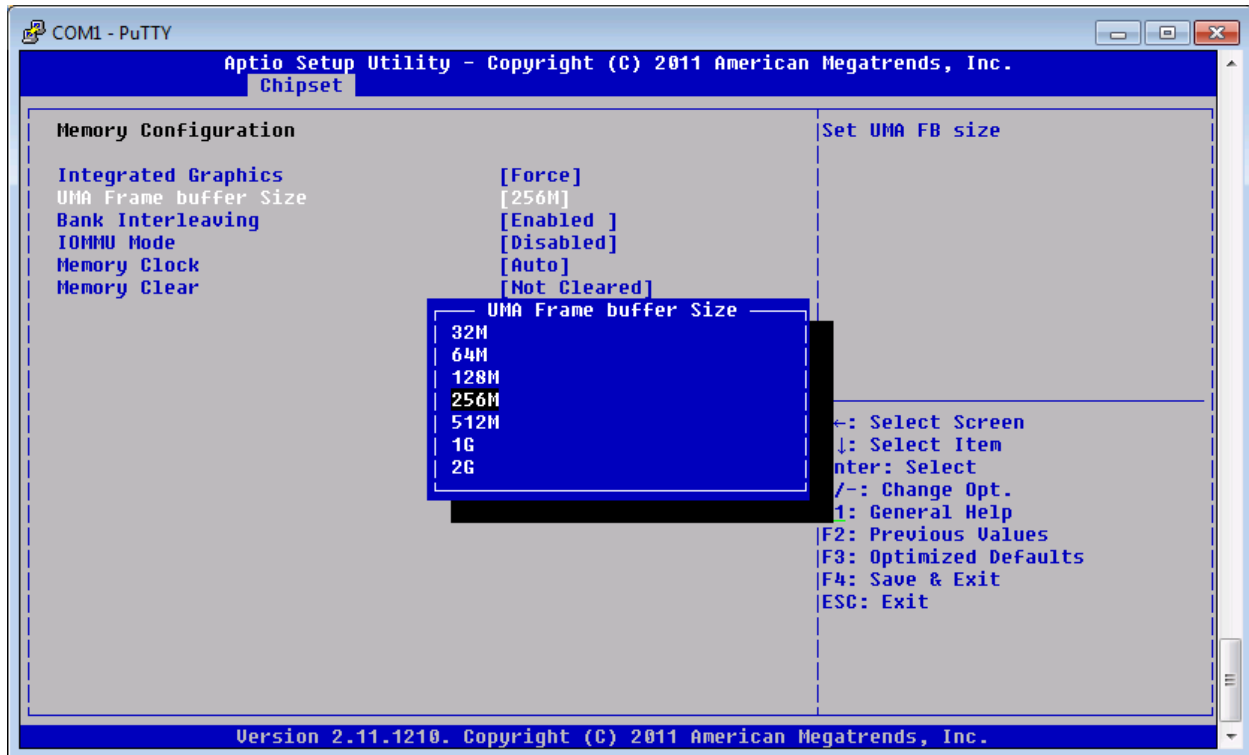

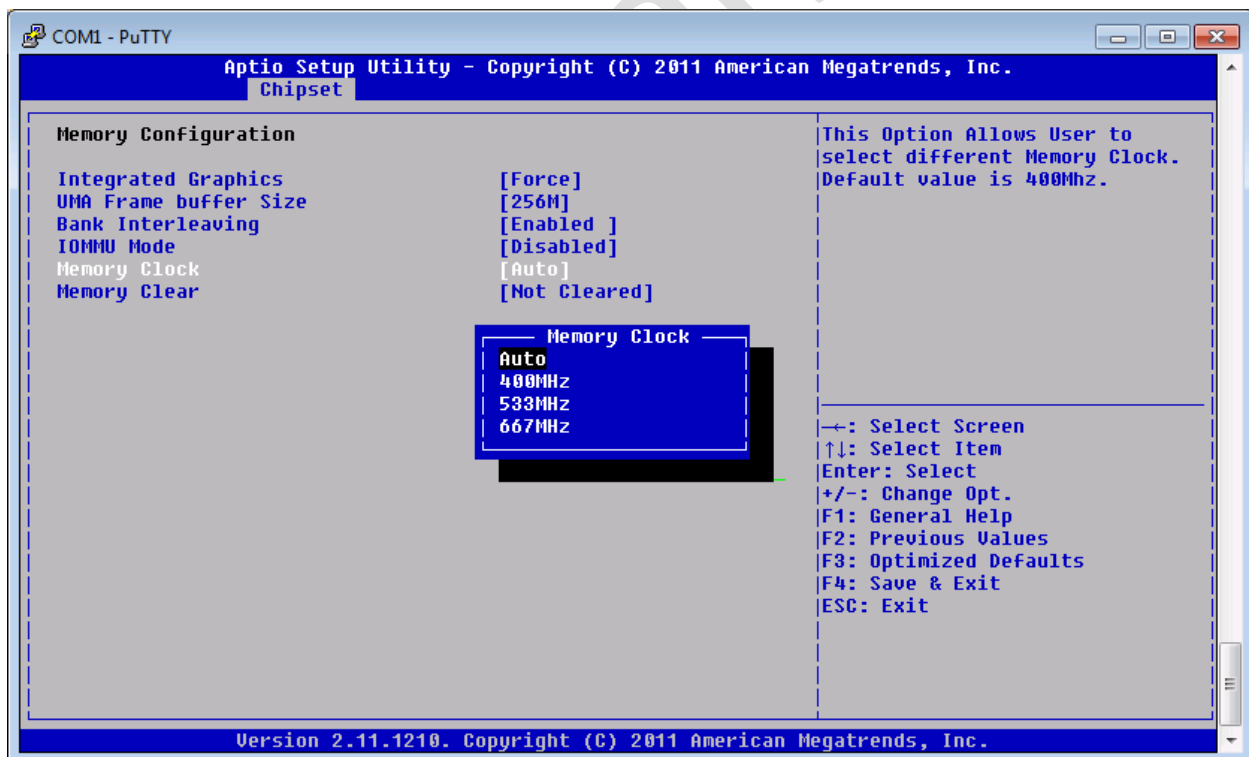
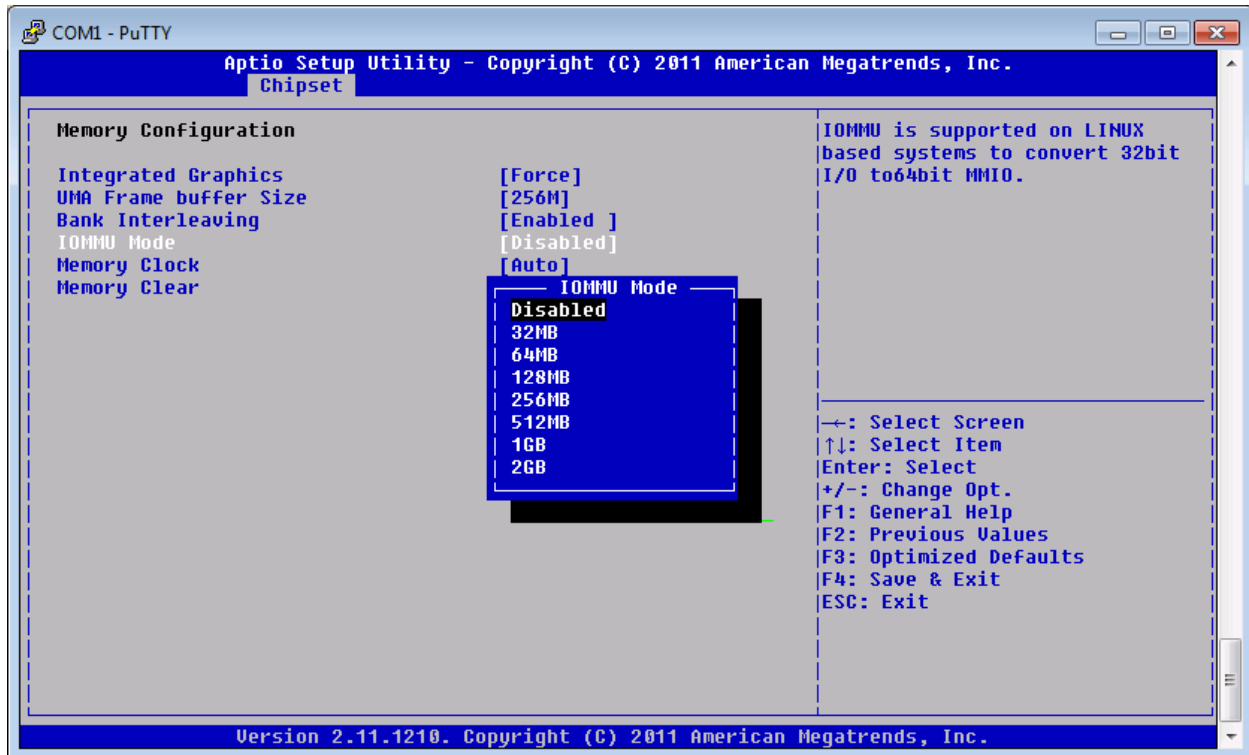

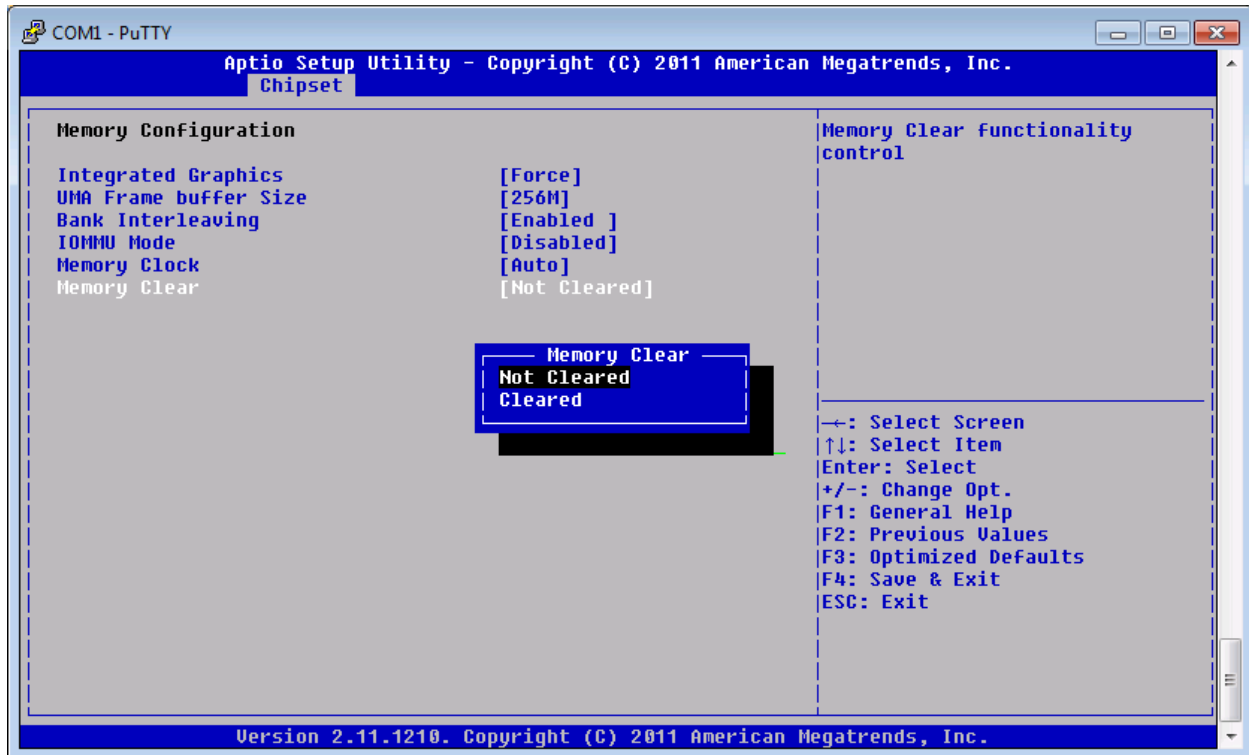

Node 0 Information

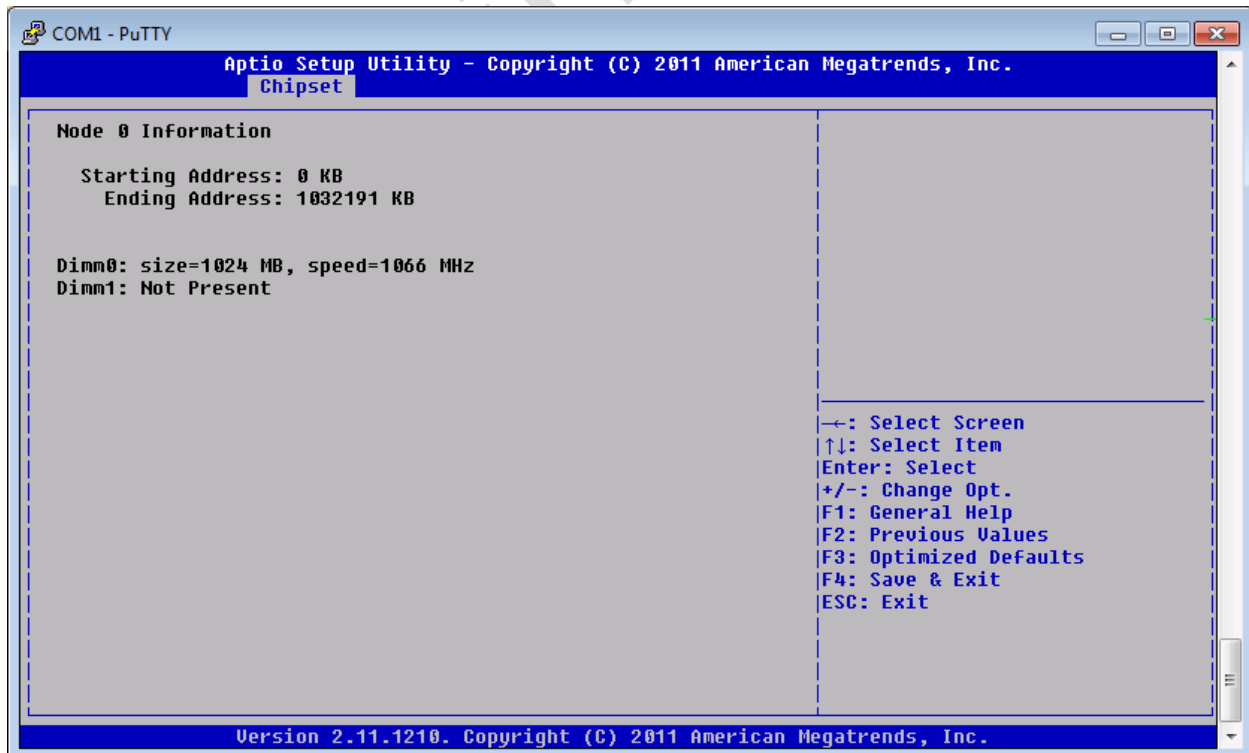

North Bridge LVDS Config Select

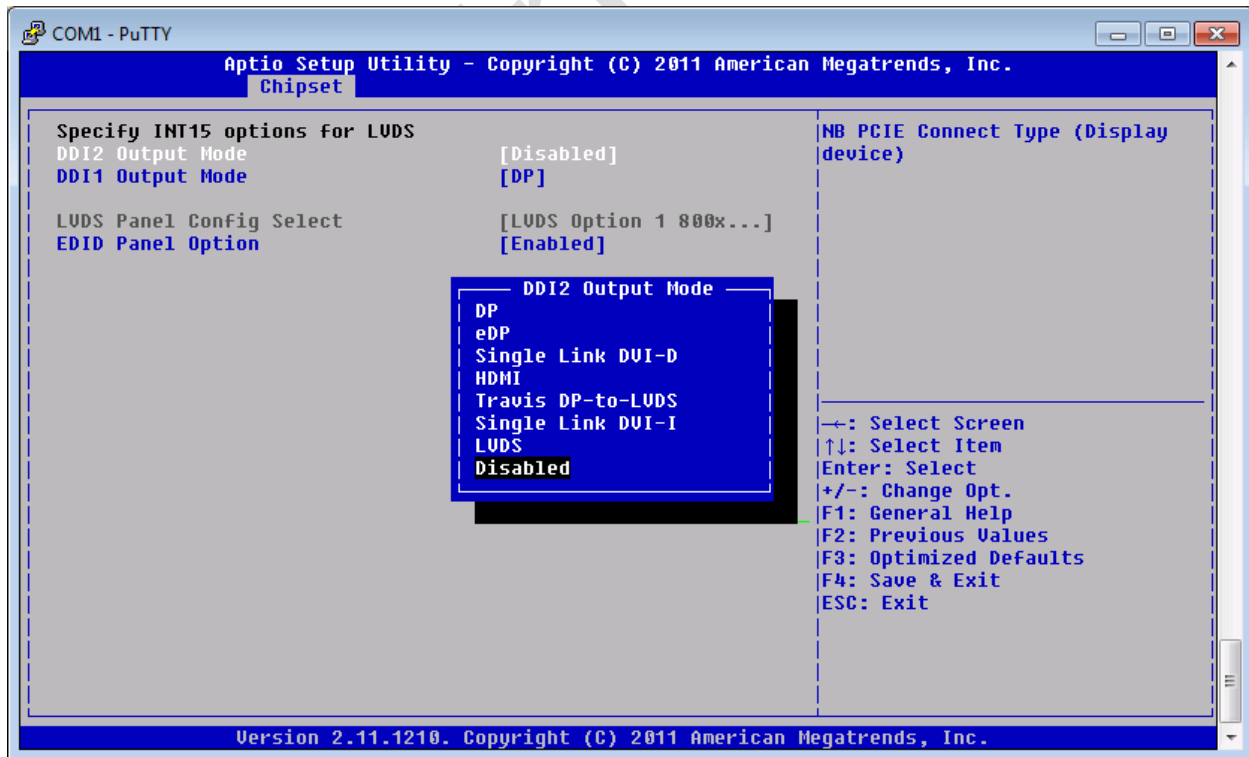
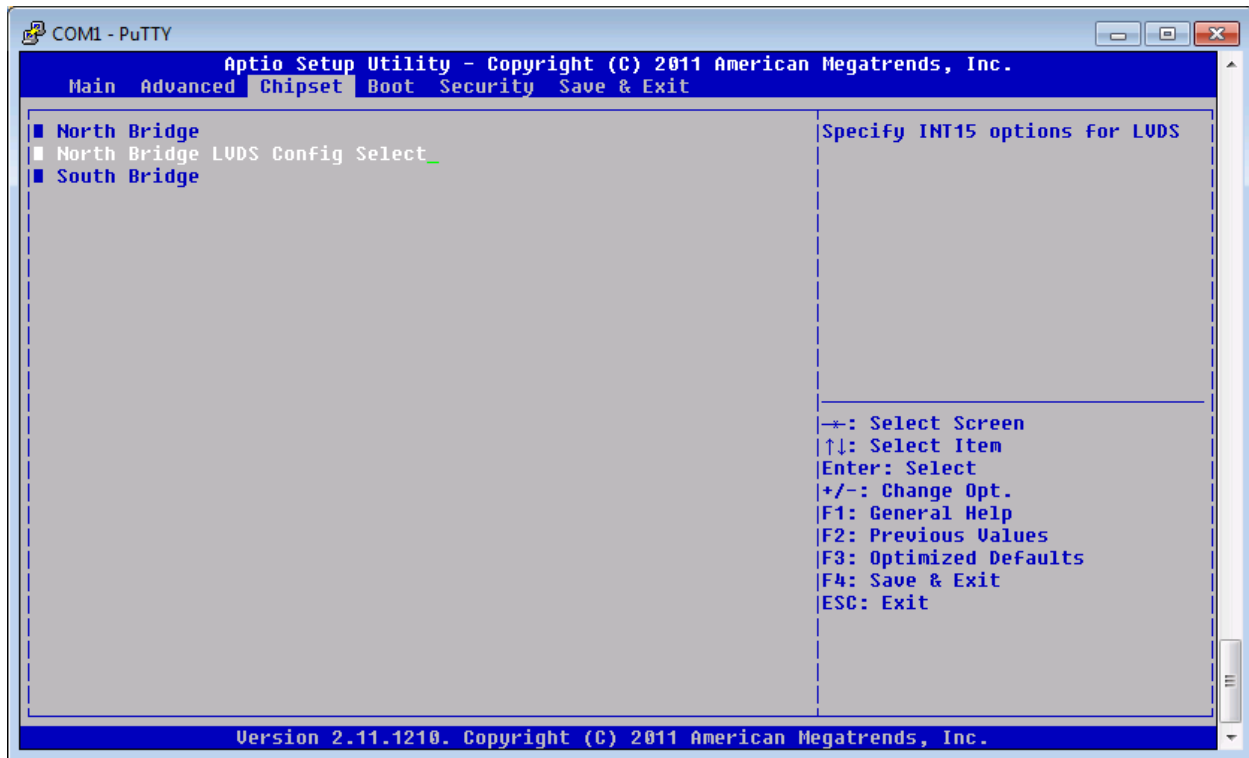

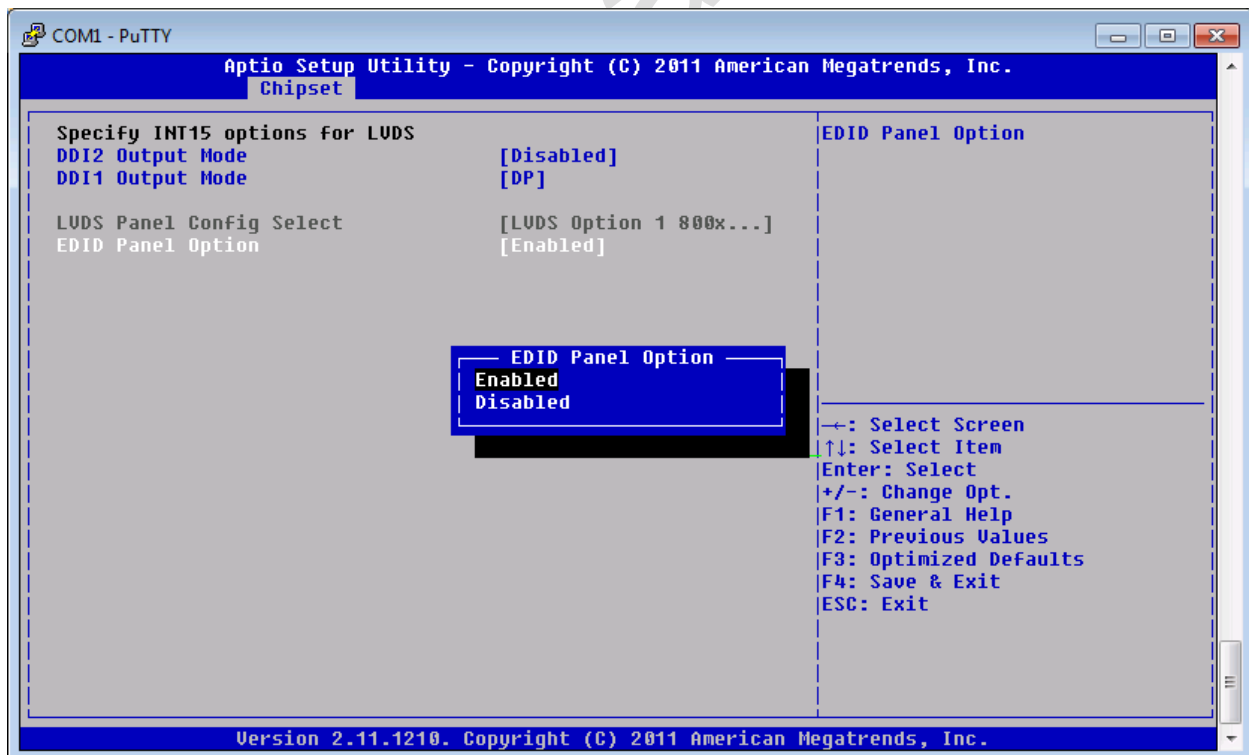
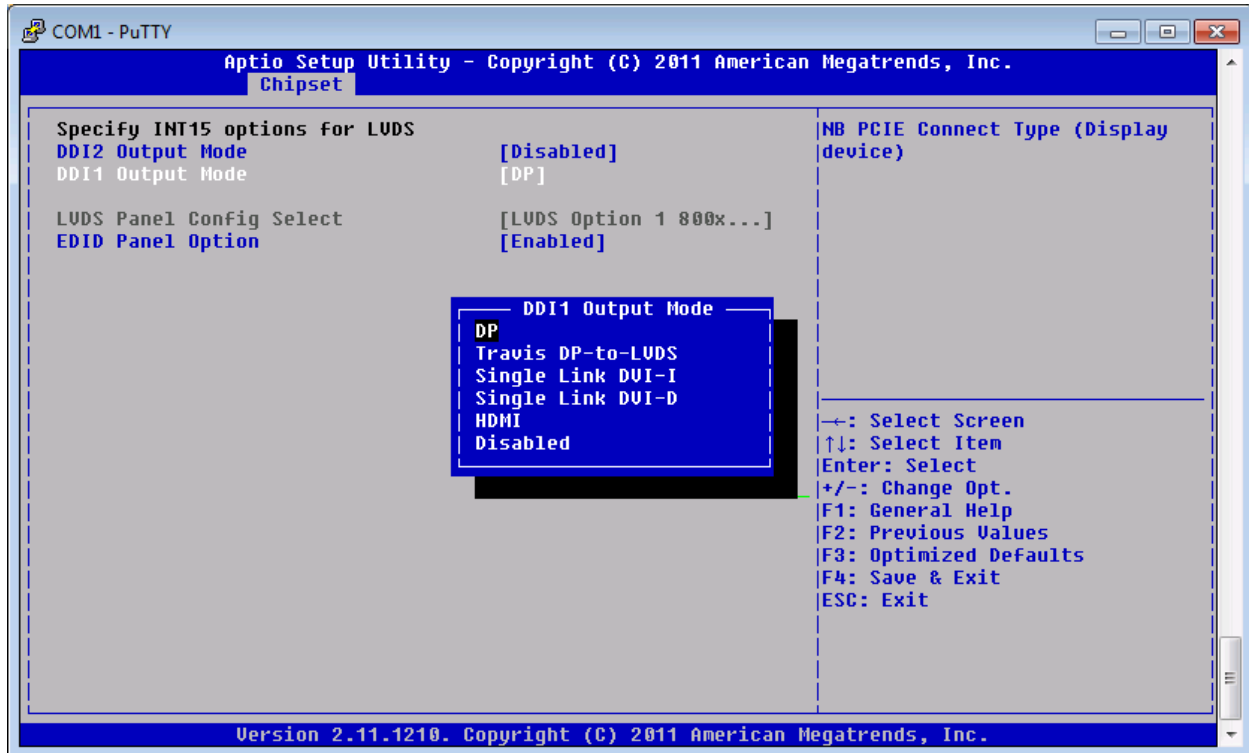

8.3.4 South Bridge

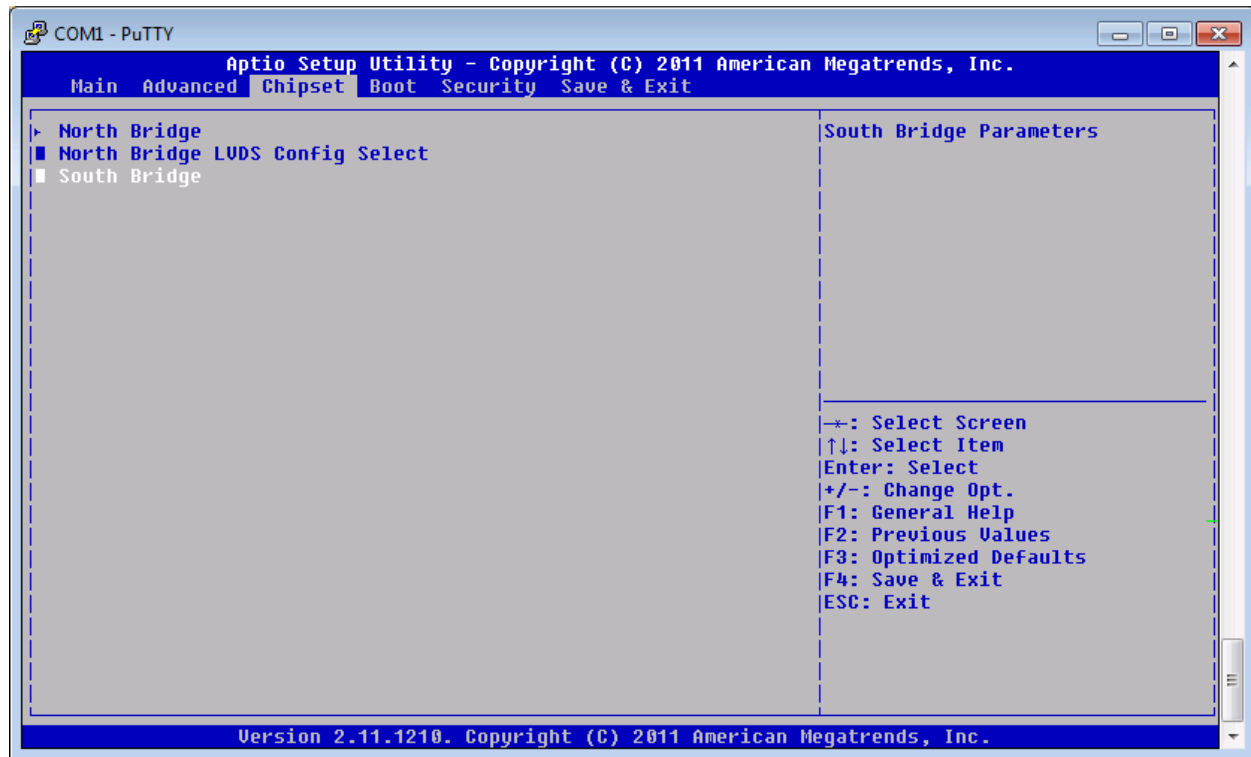

South Bridge SATA Configuration

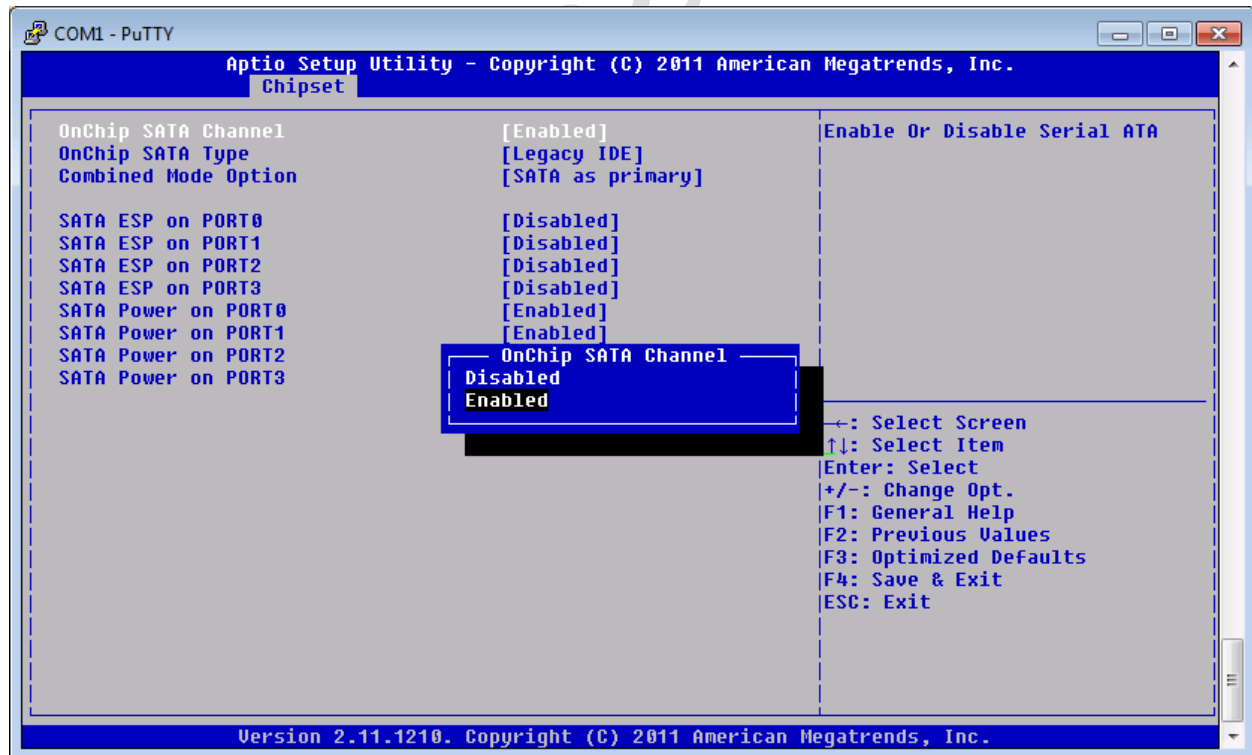
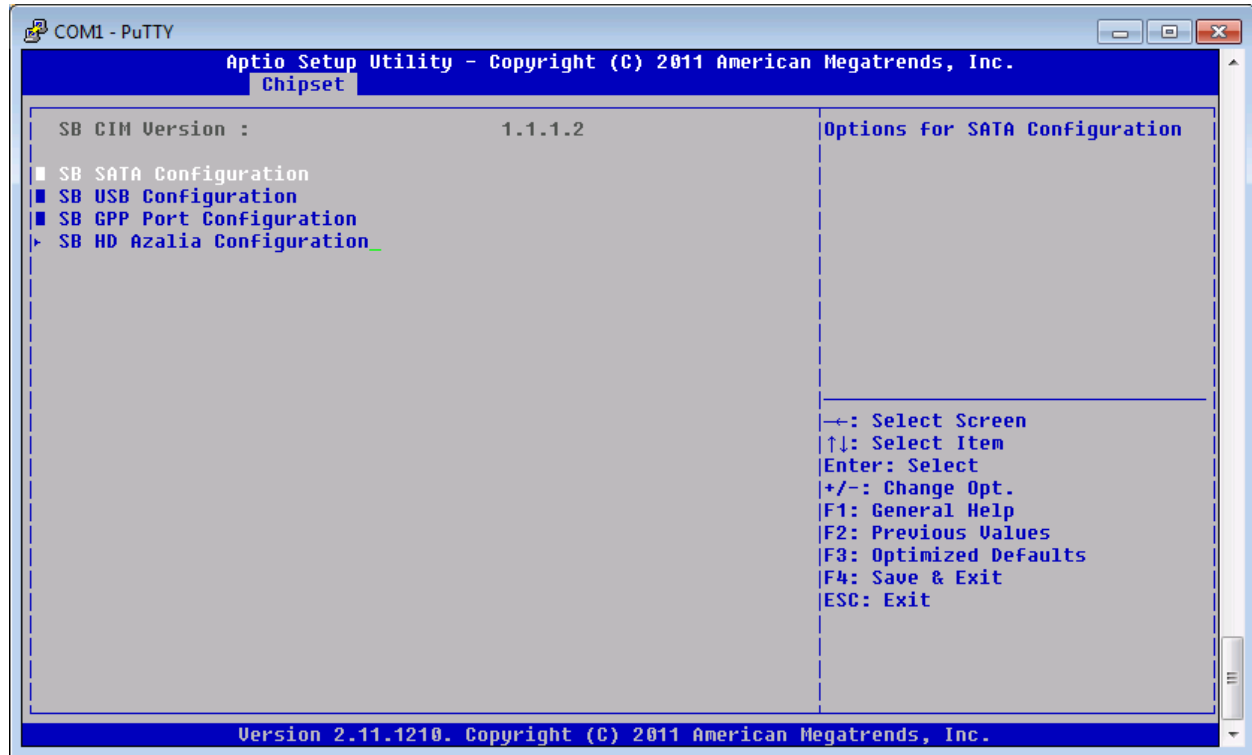

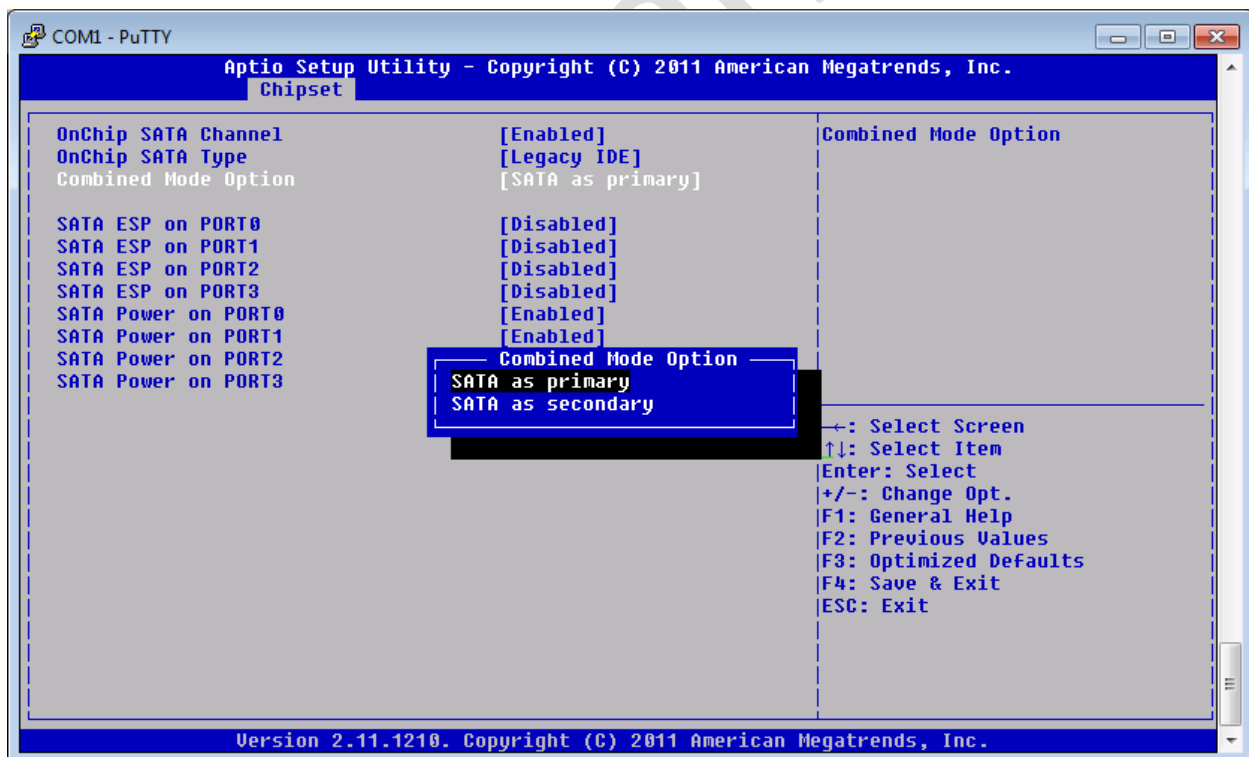
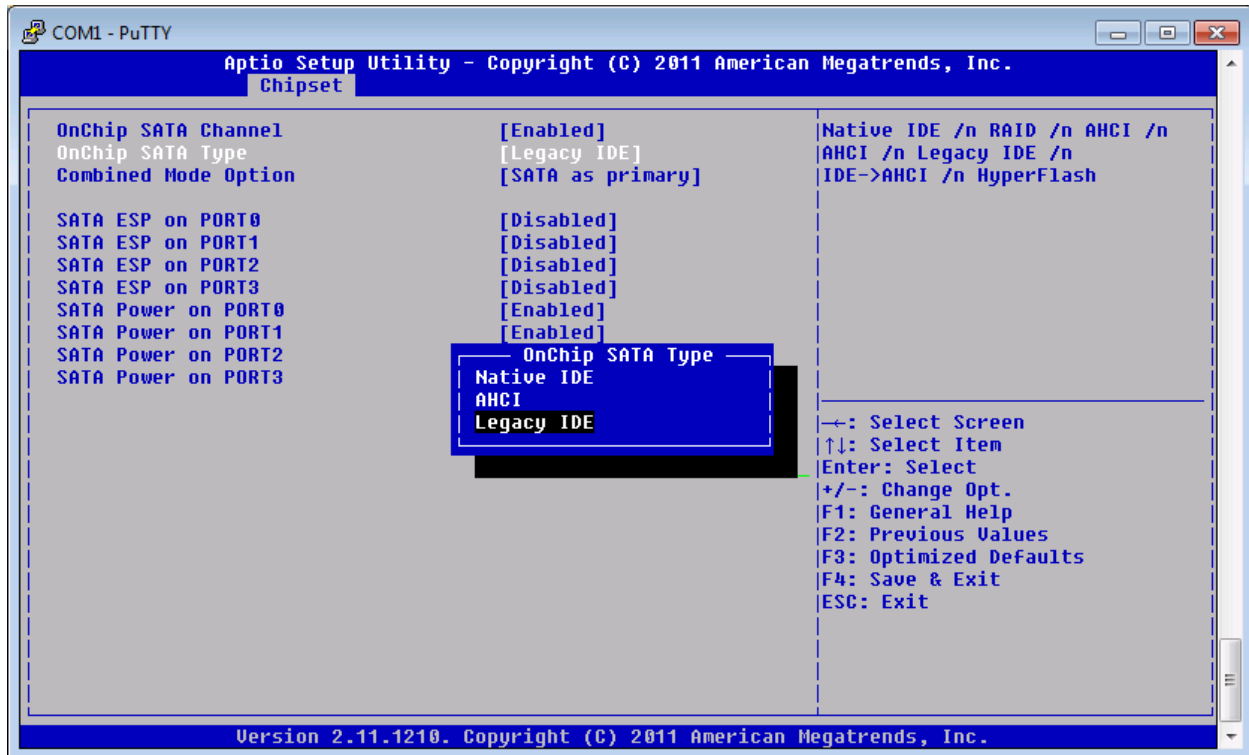

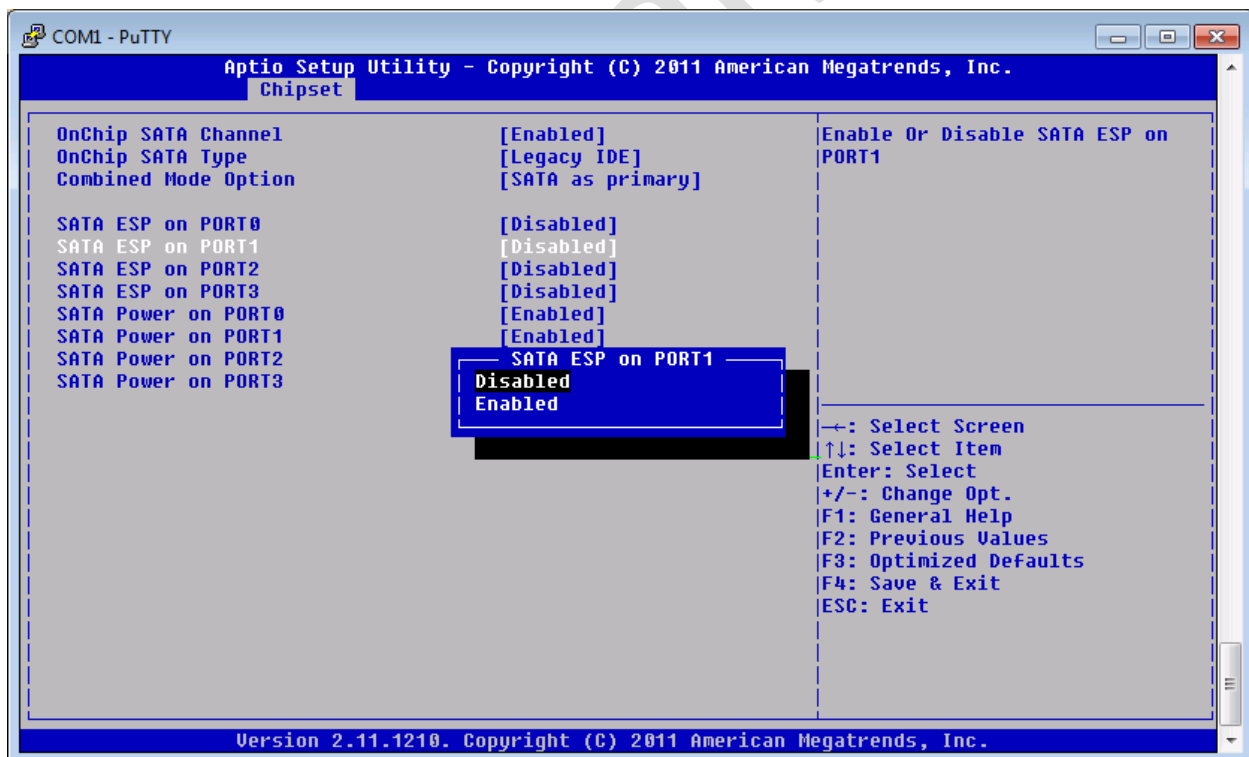
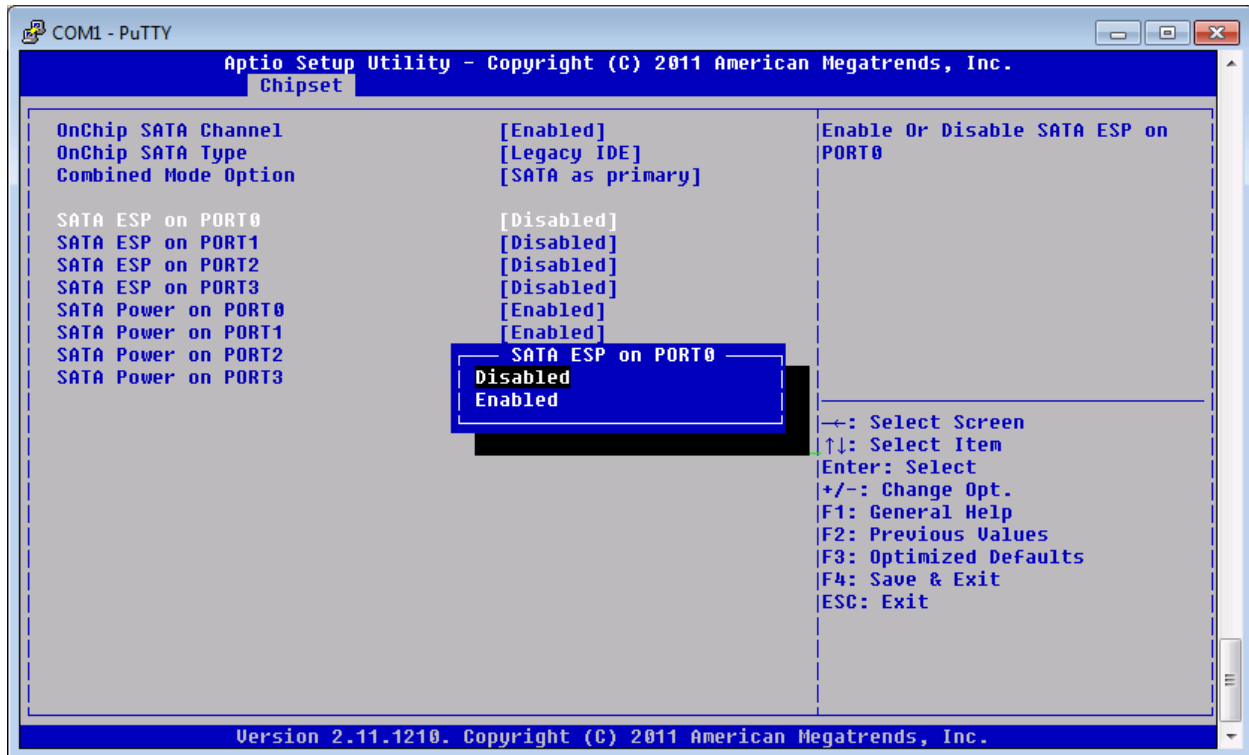

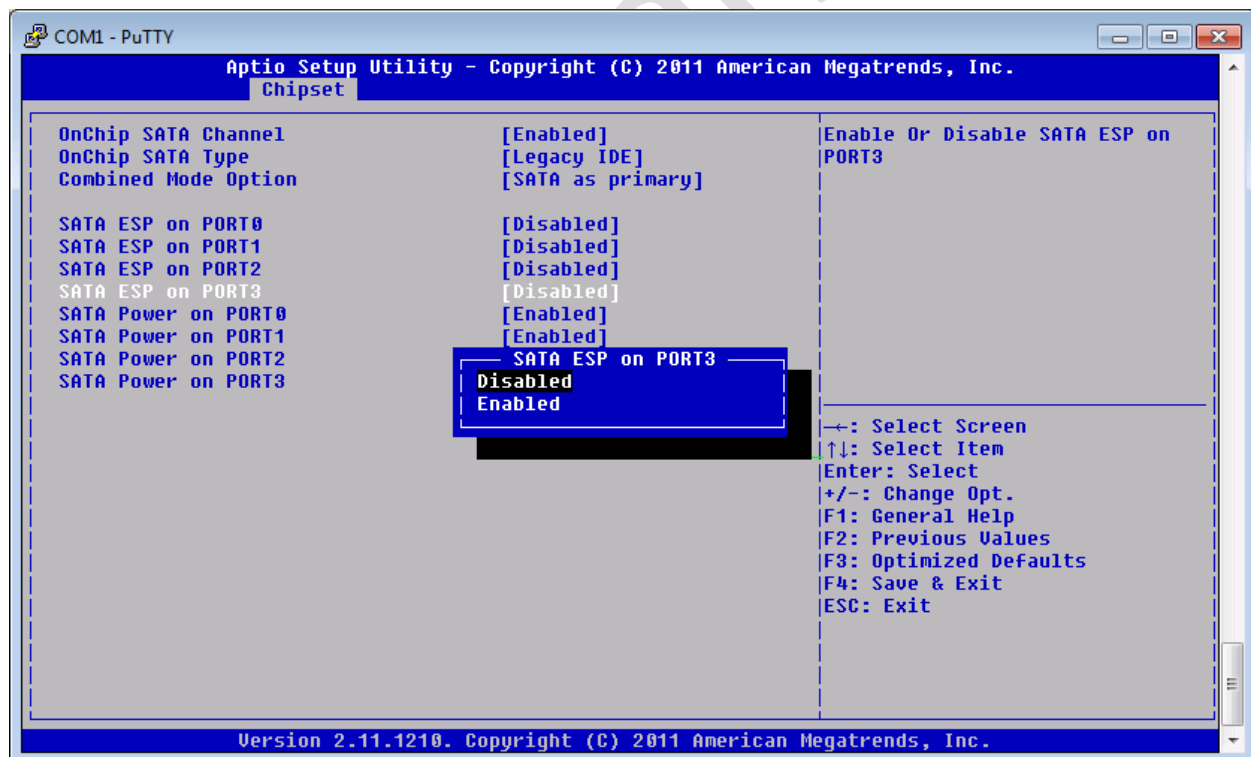
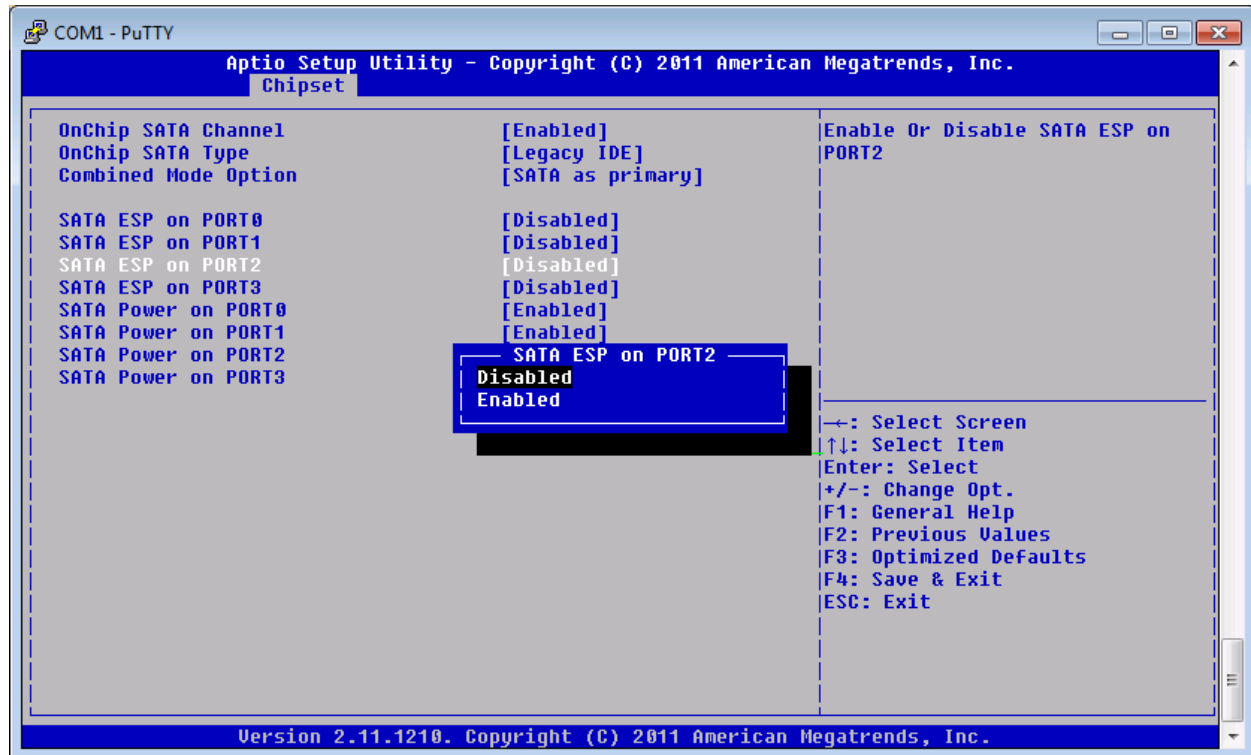

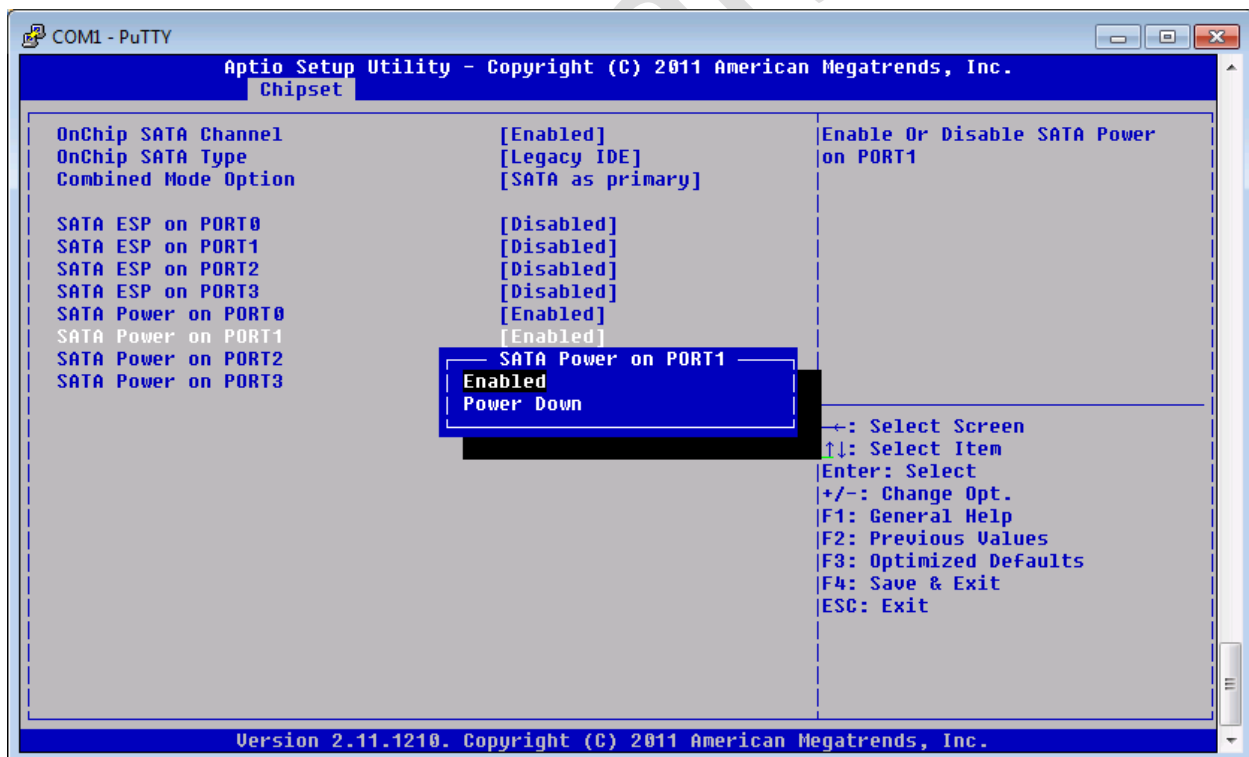
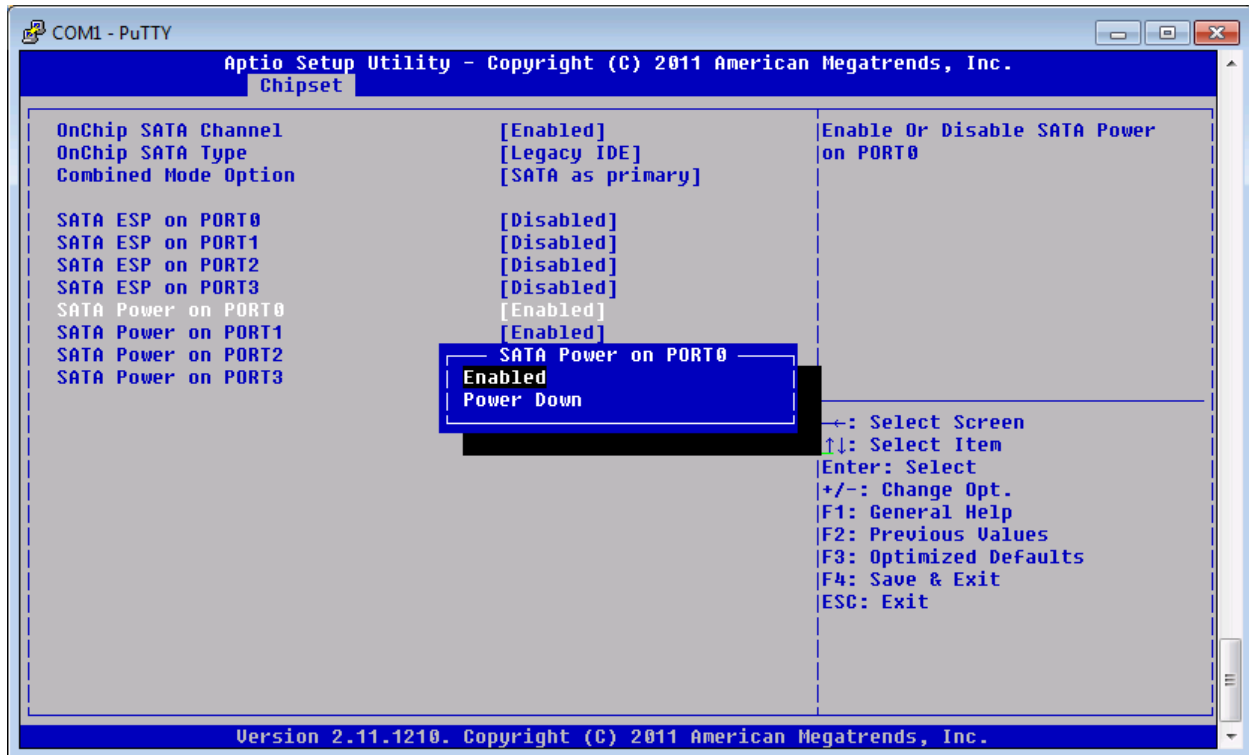

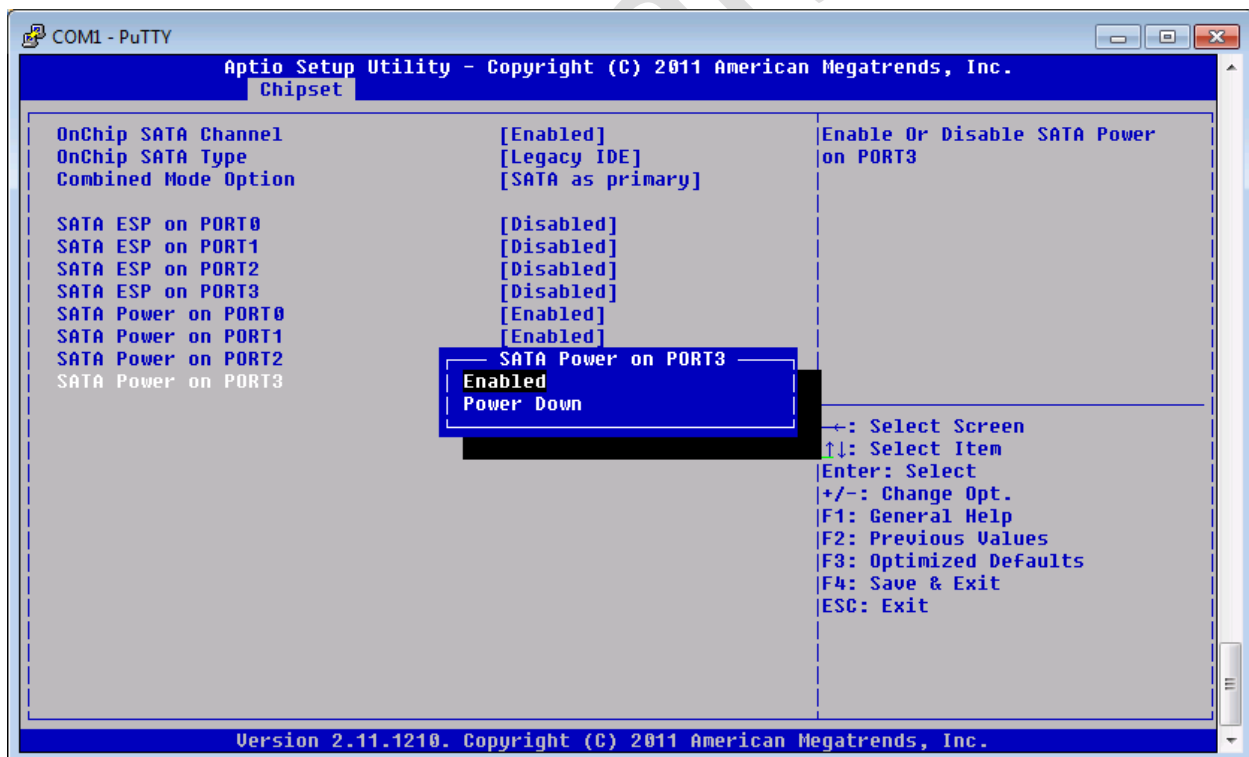
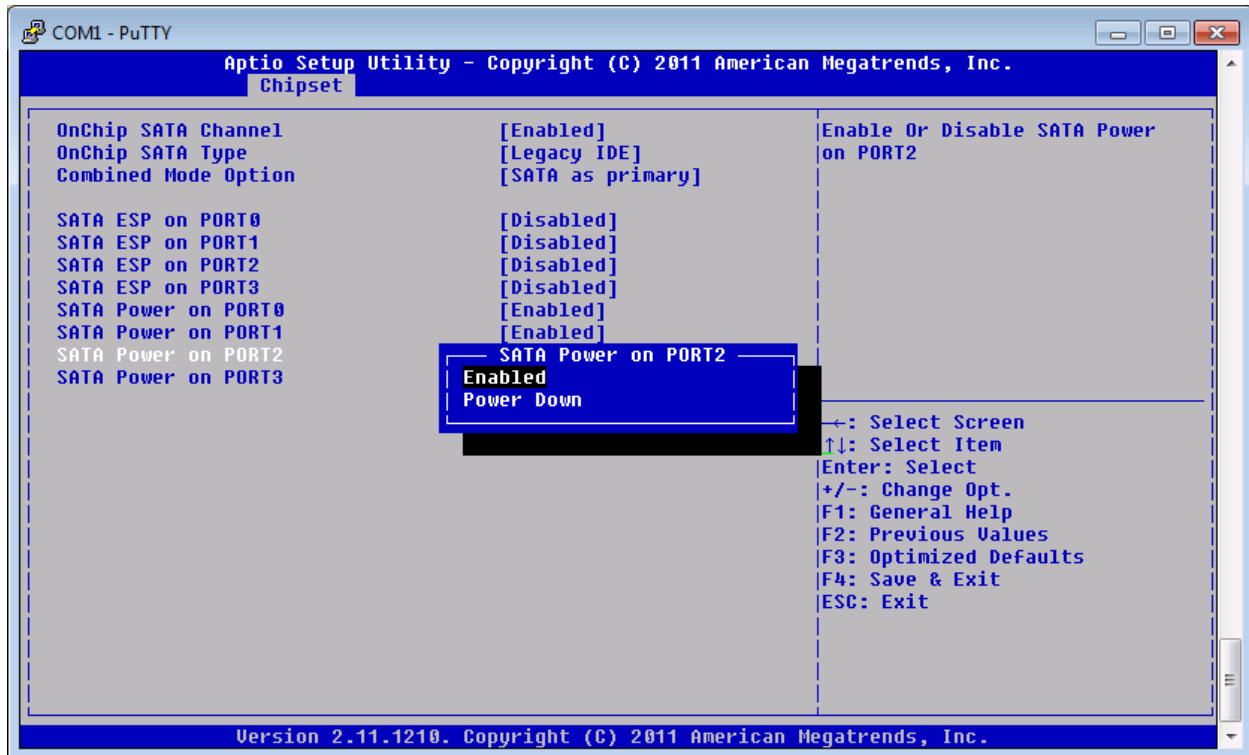

South Bridge USB Configuration

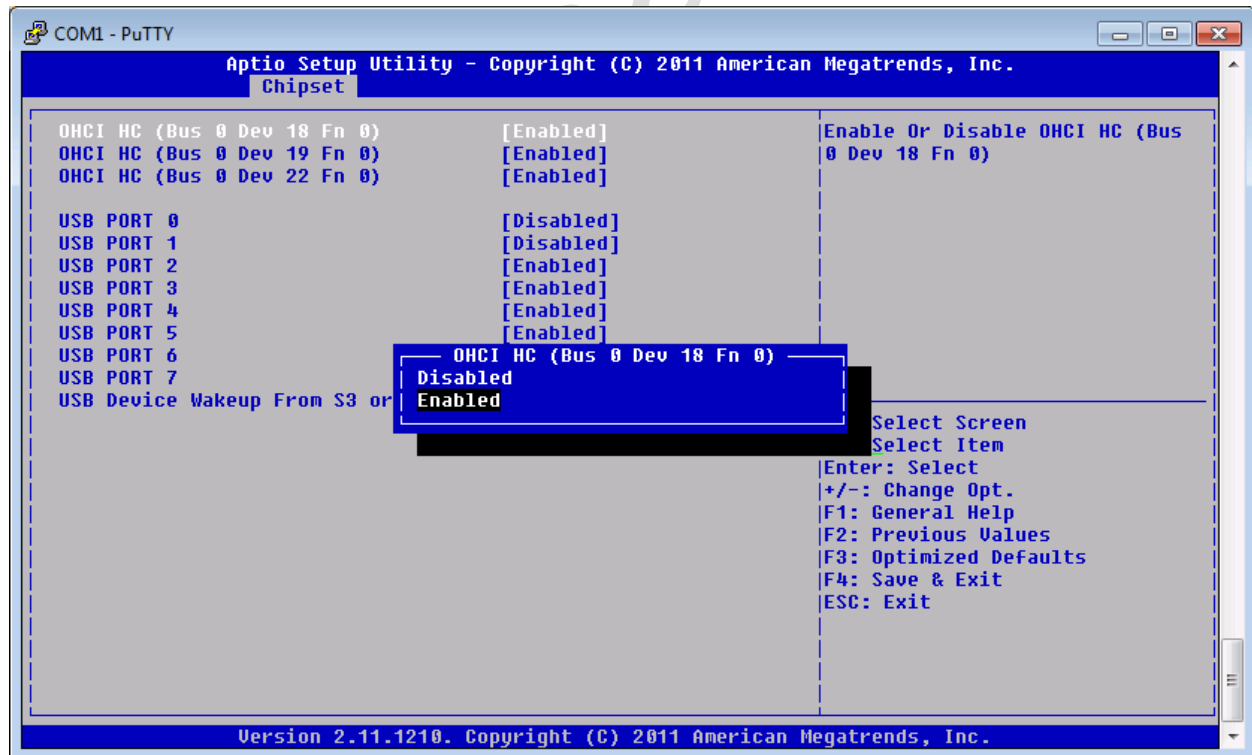
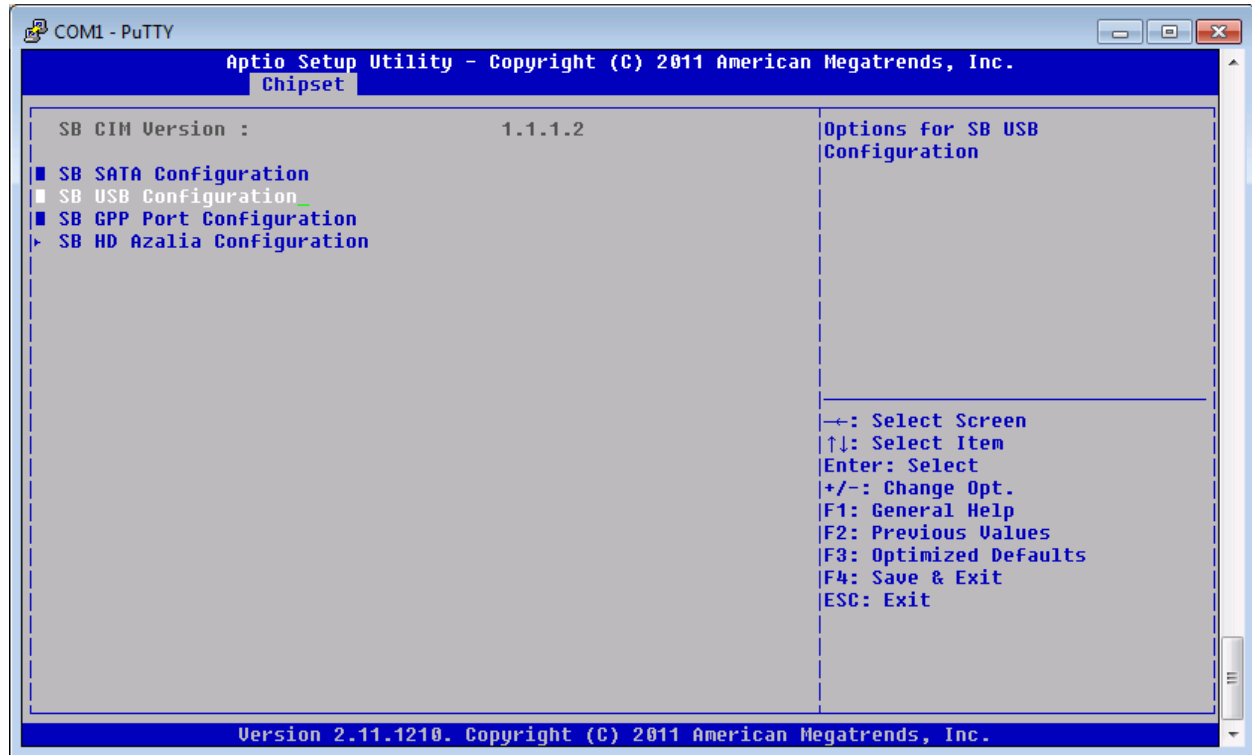

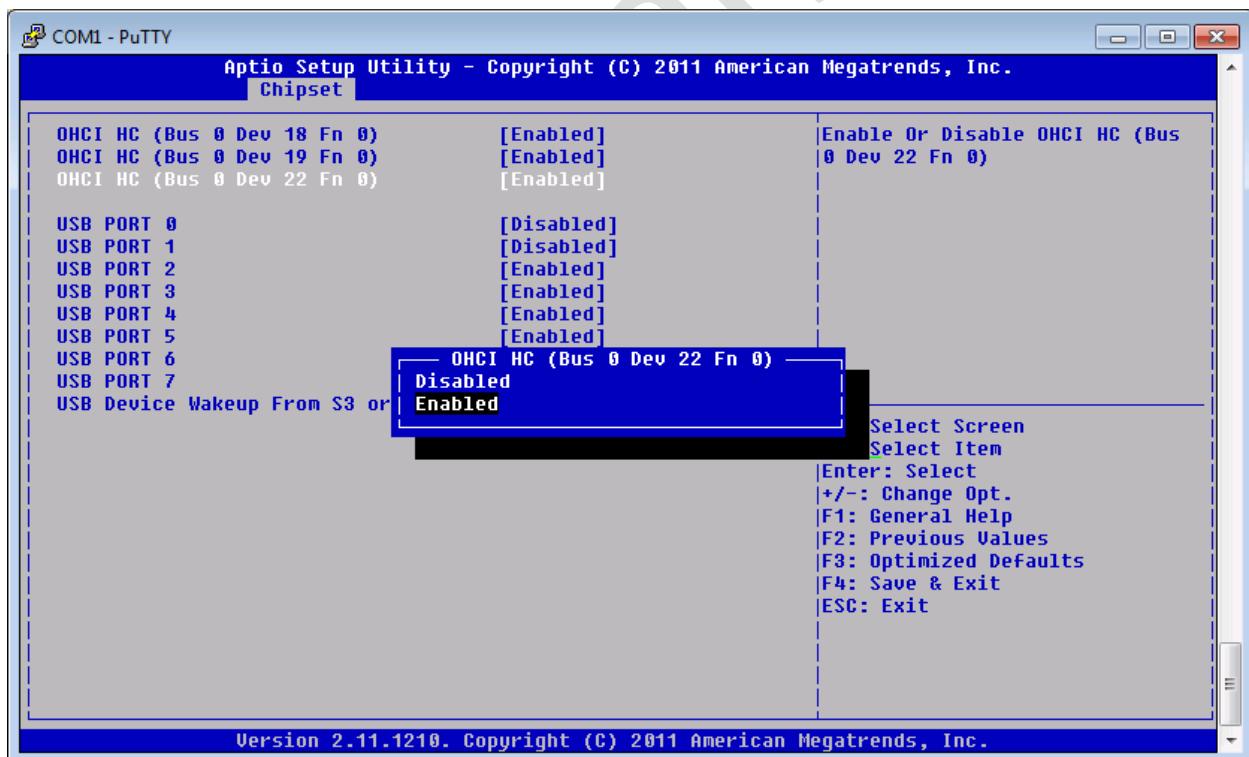
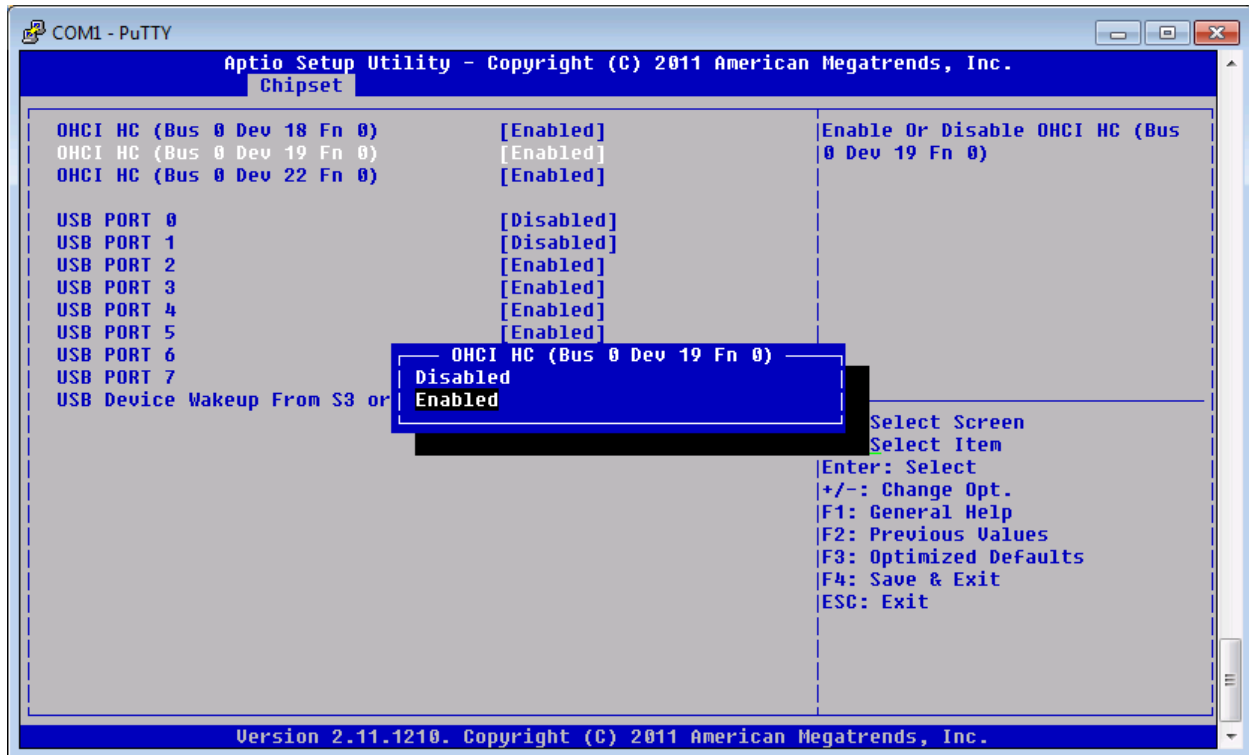

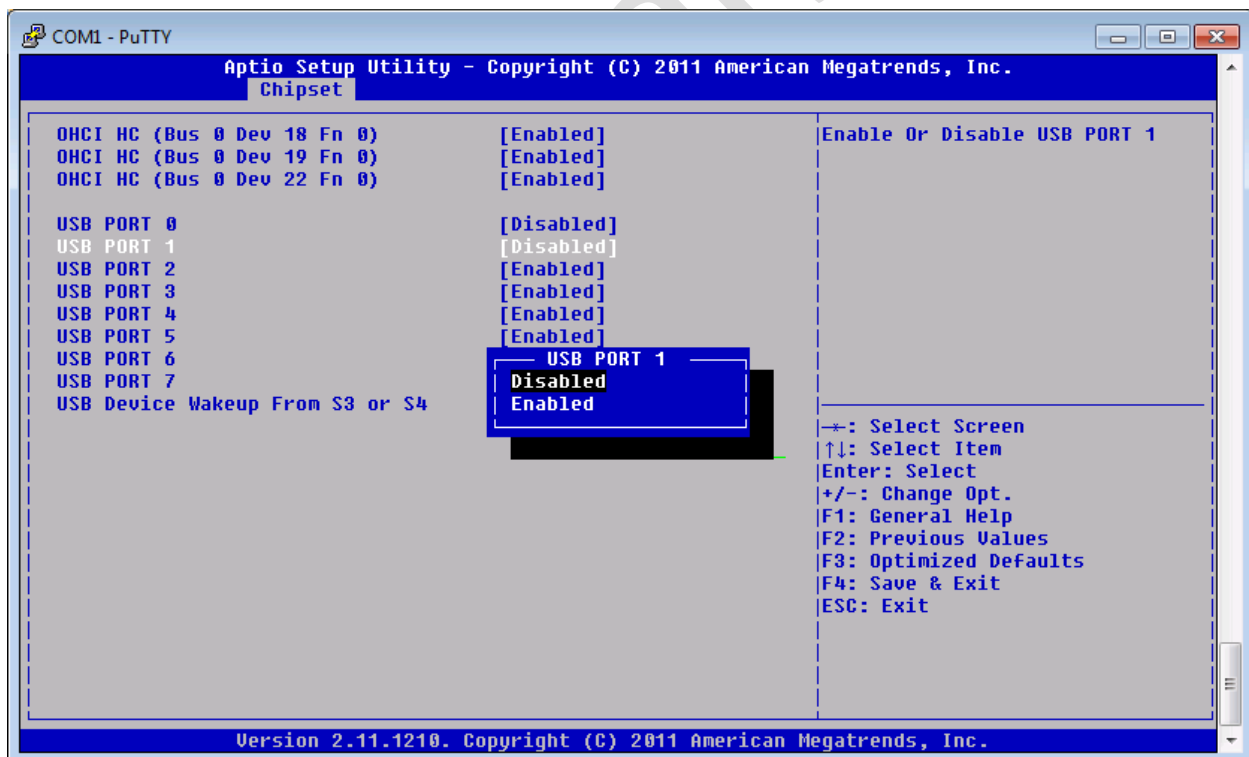
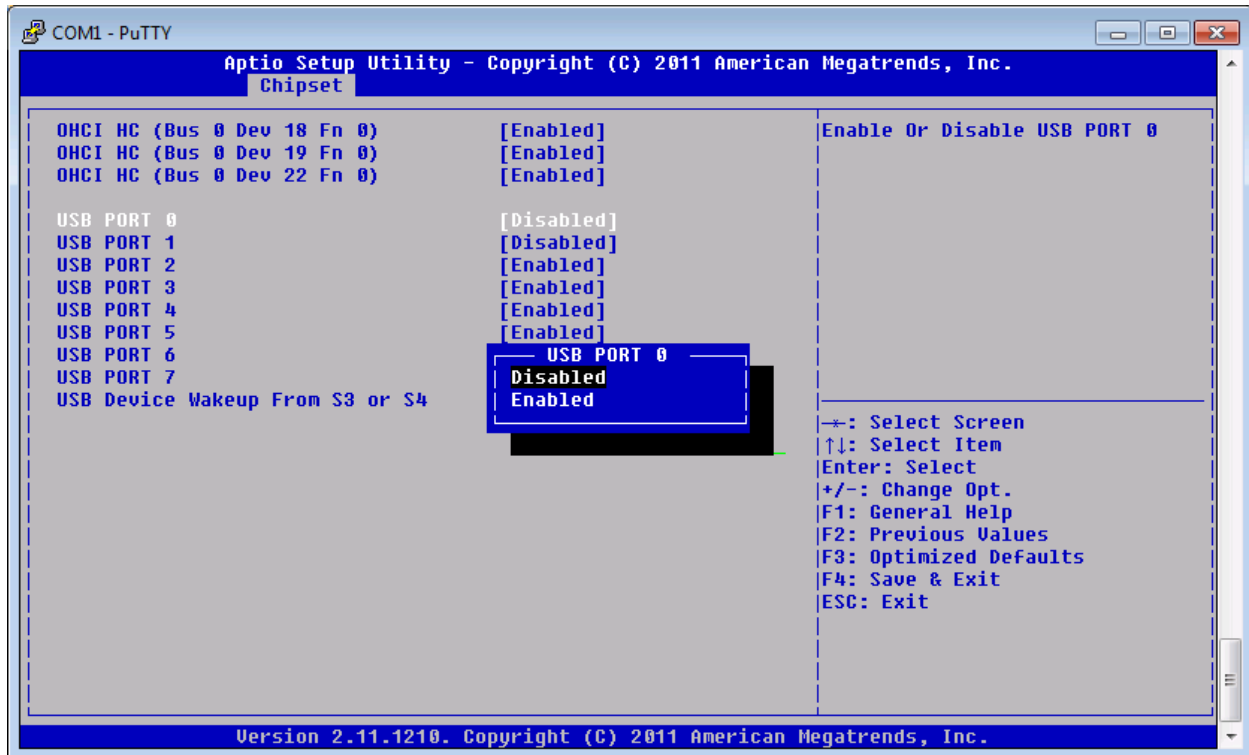

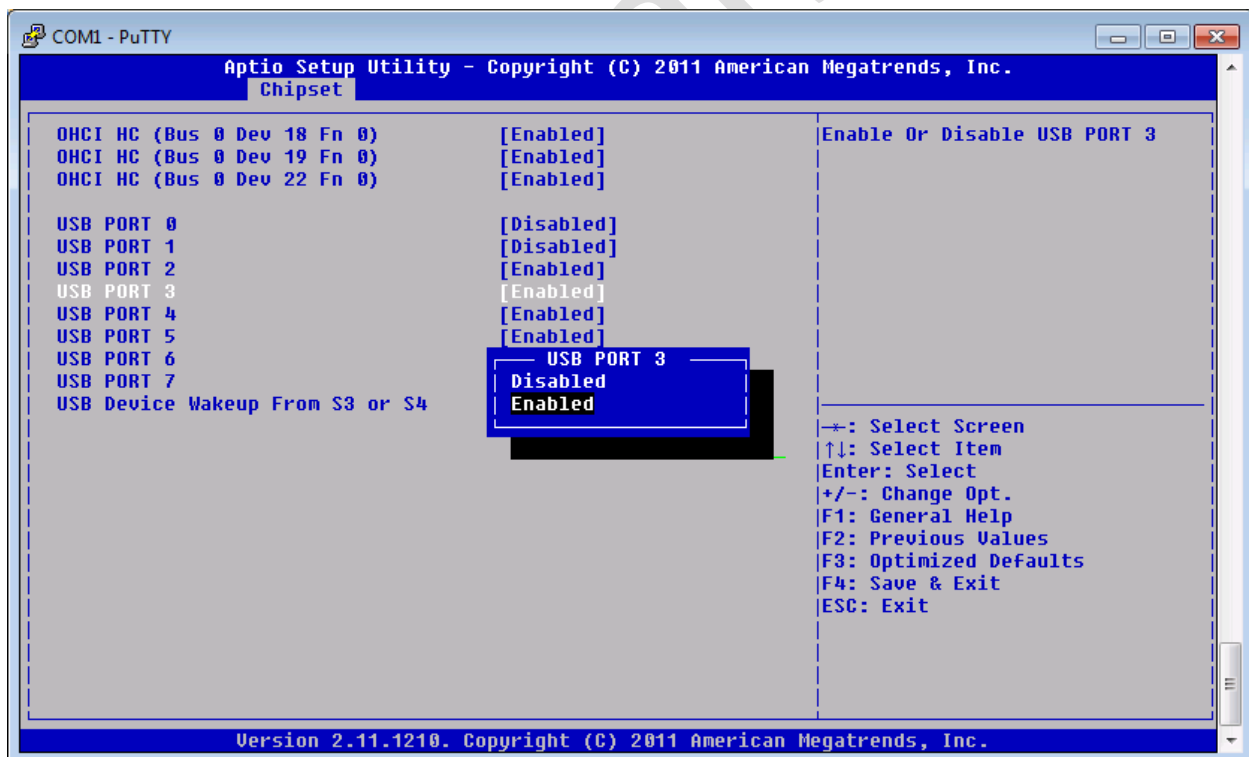
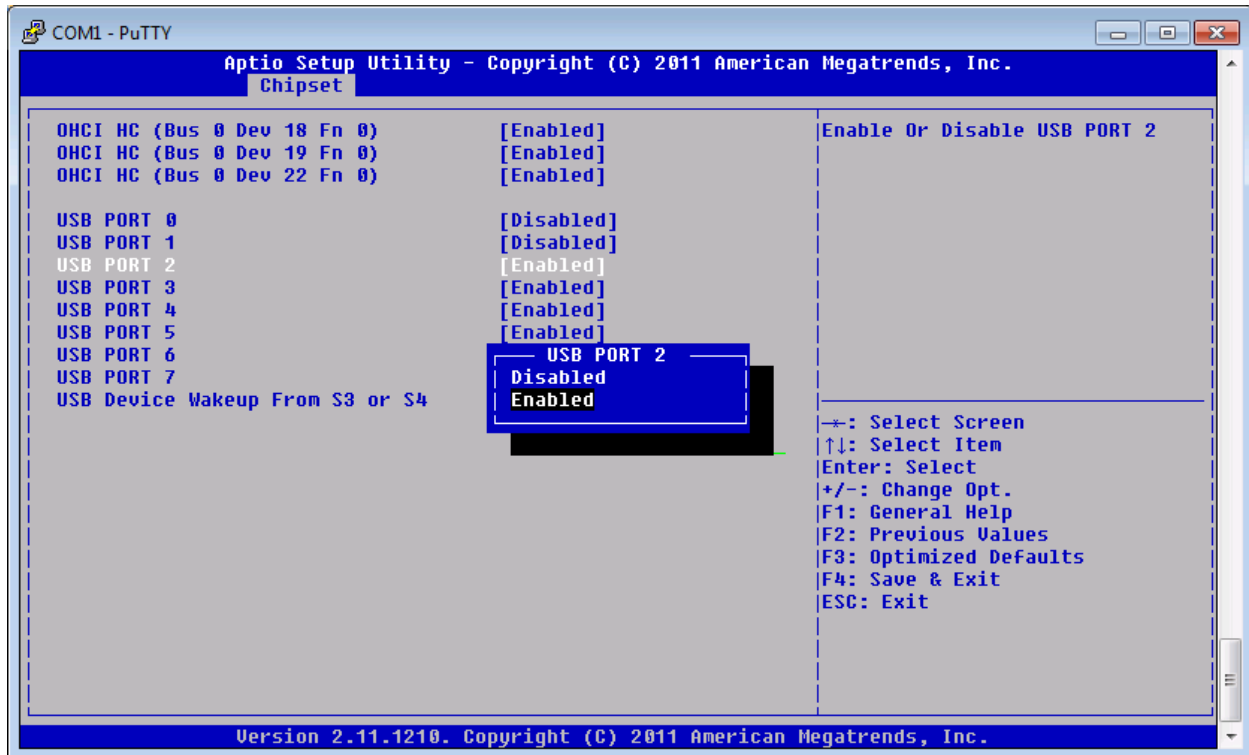

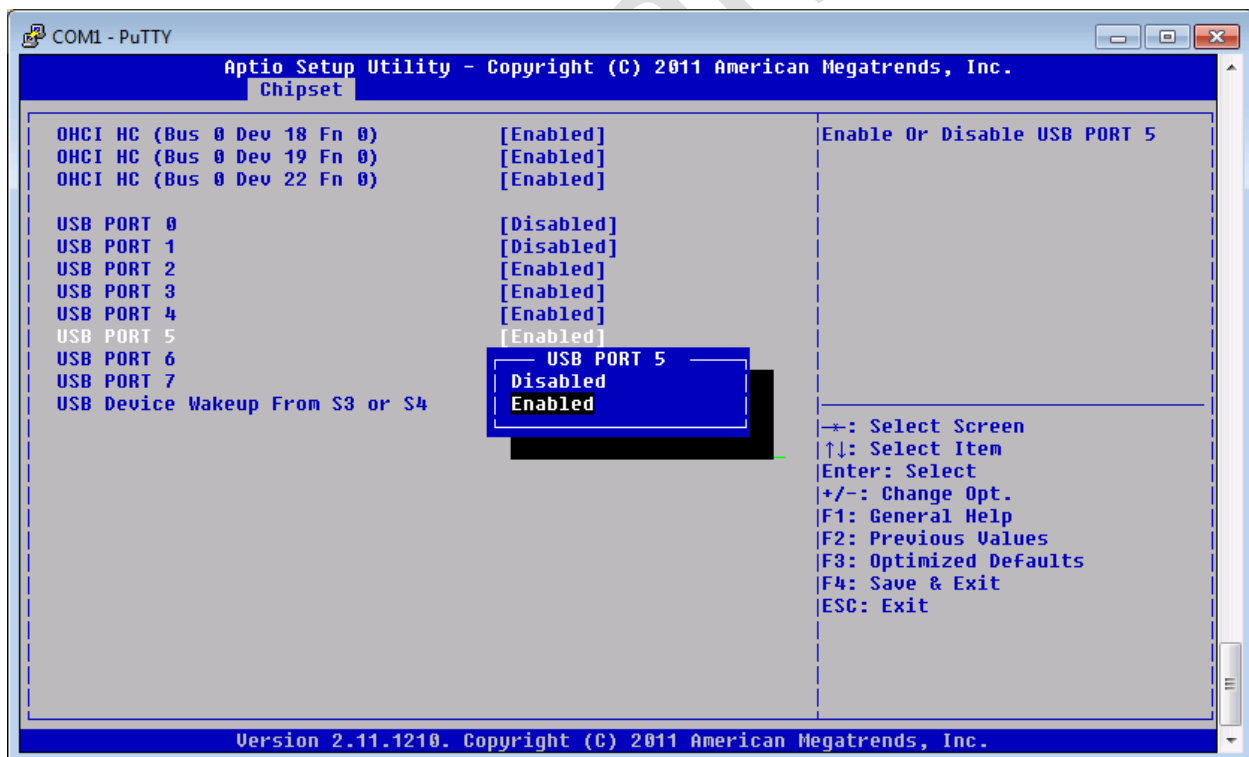
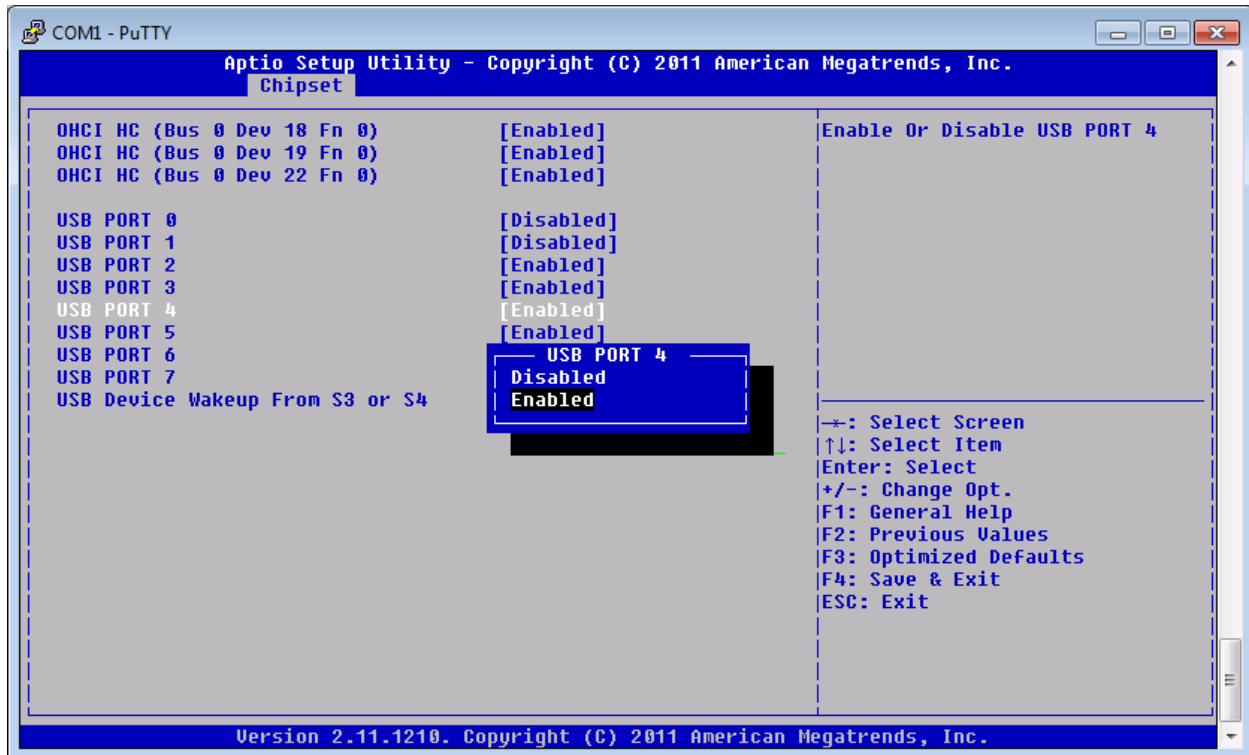

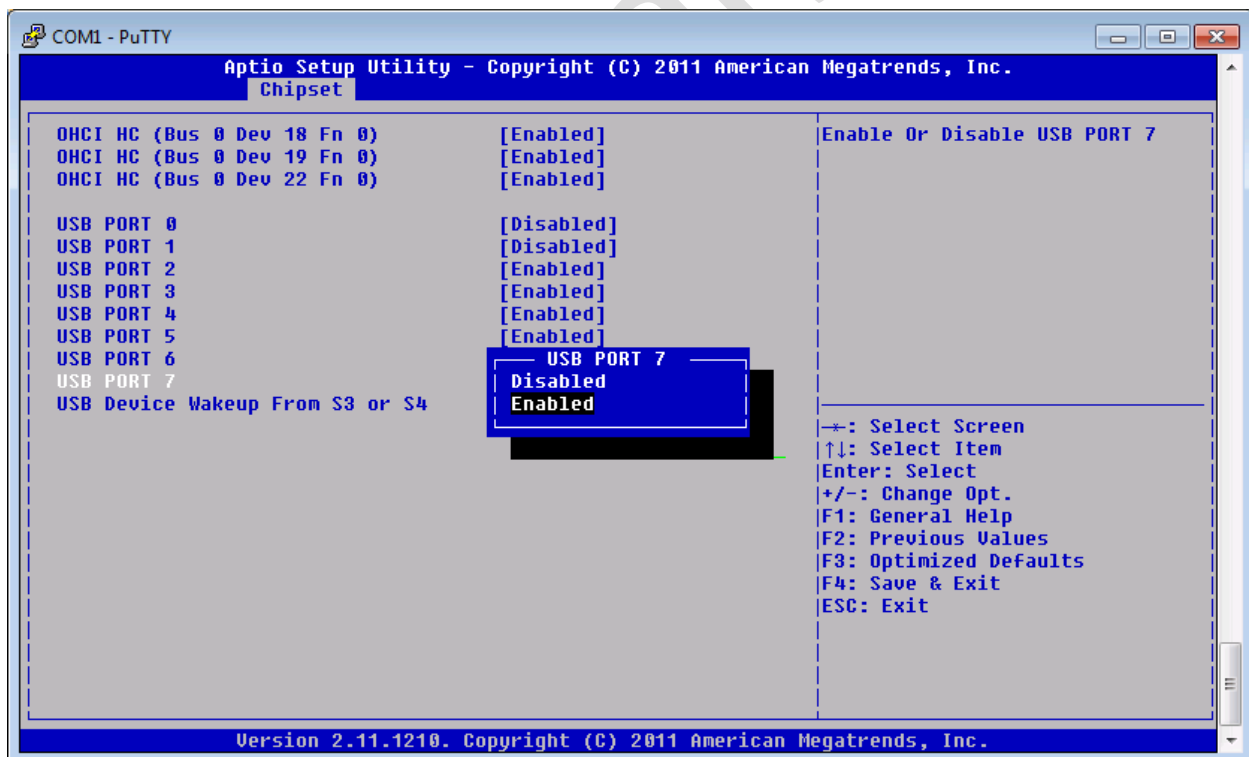
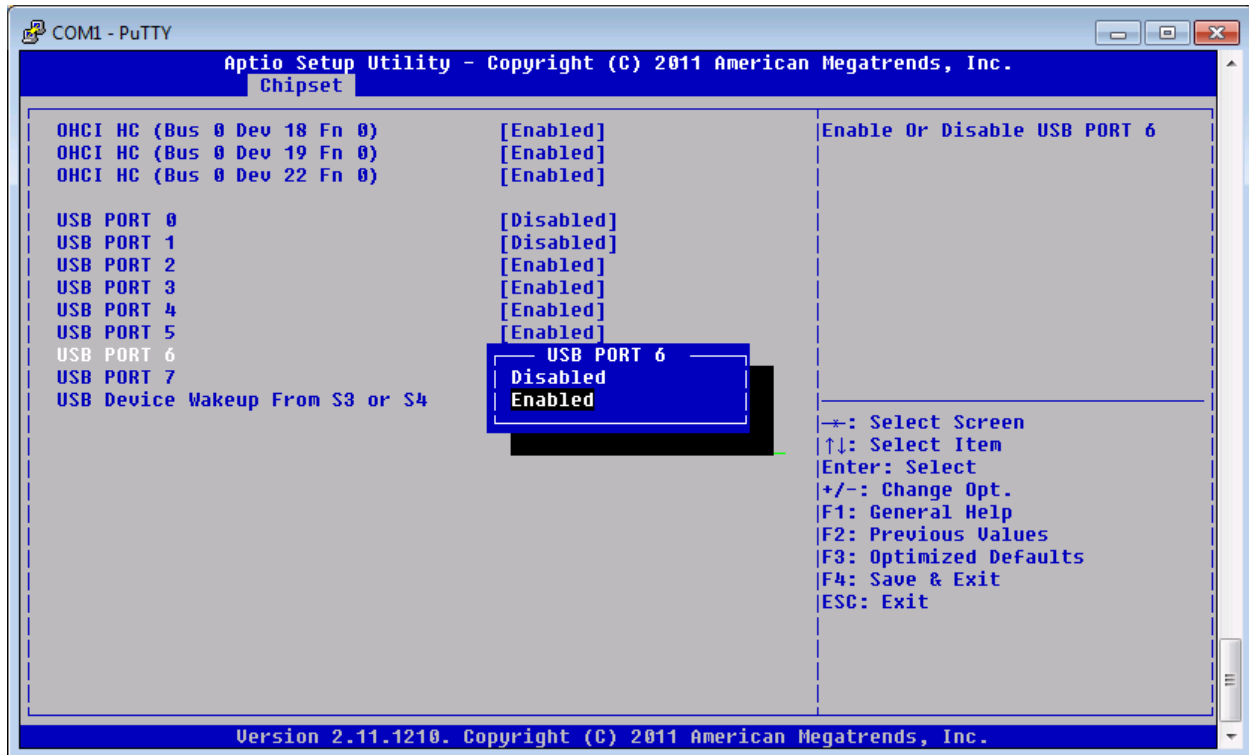

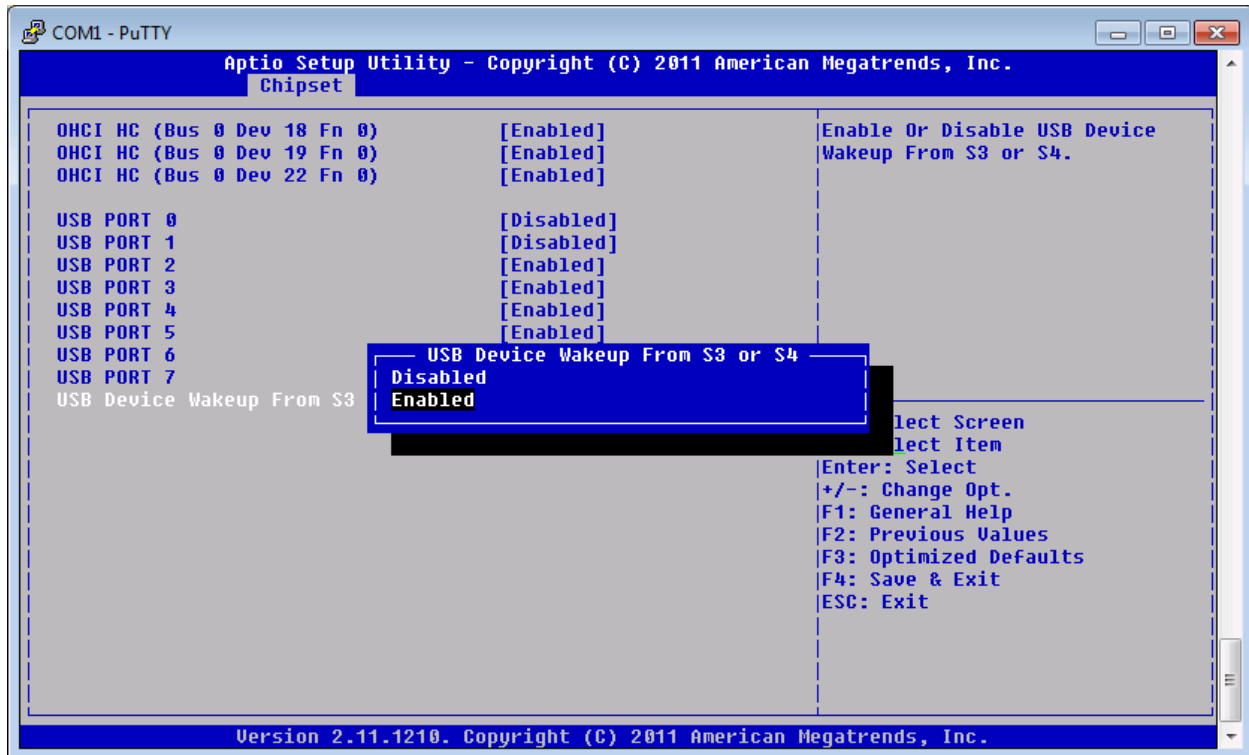

South Bridge GPP Port Configuration

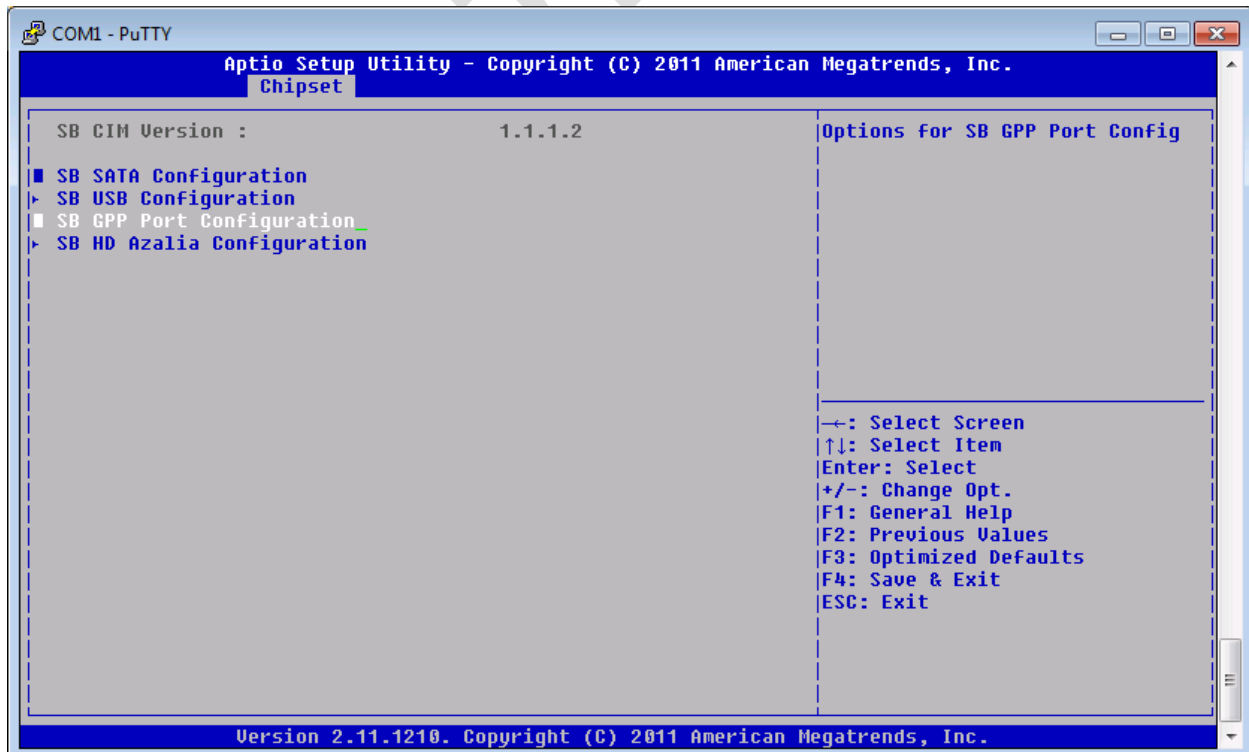

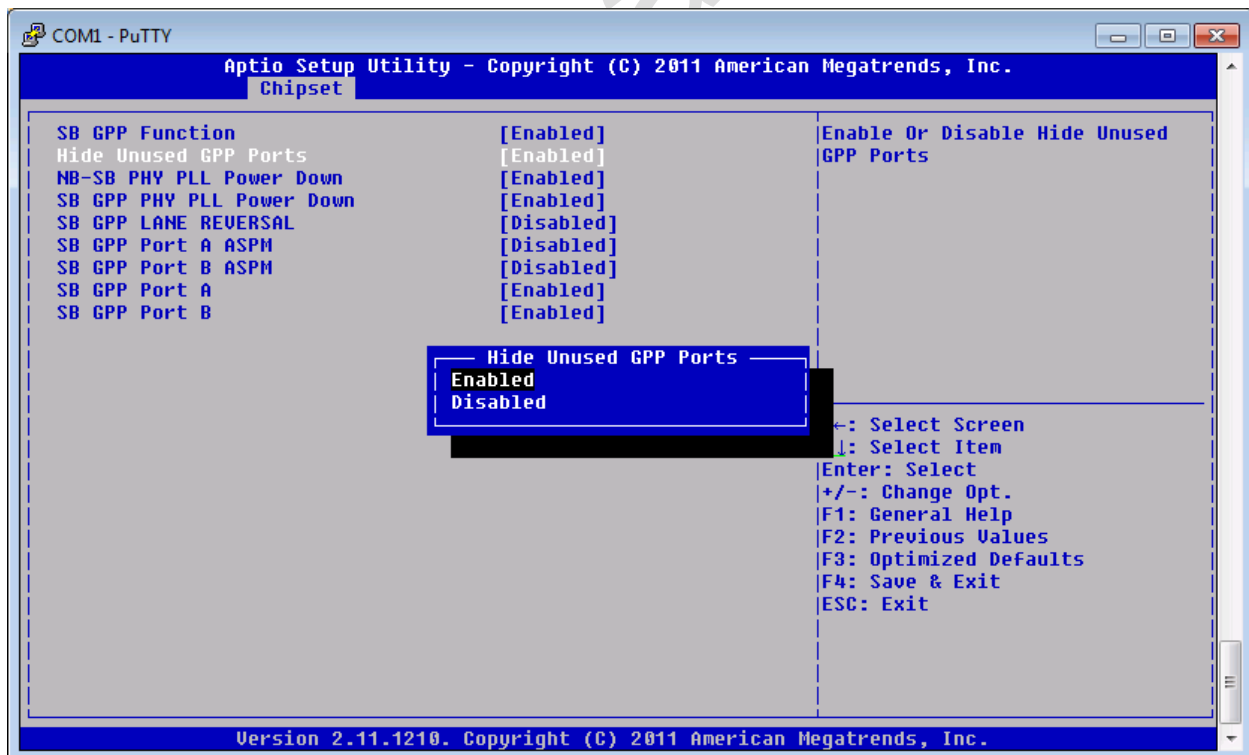
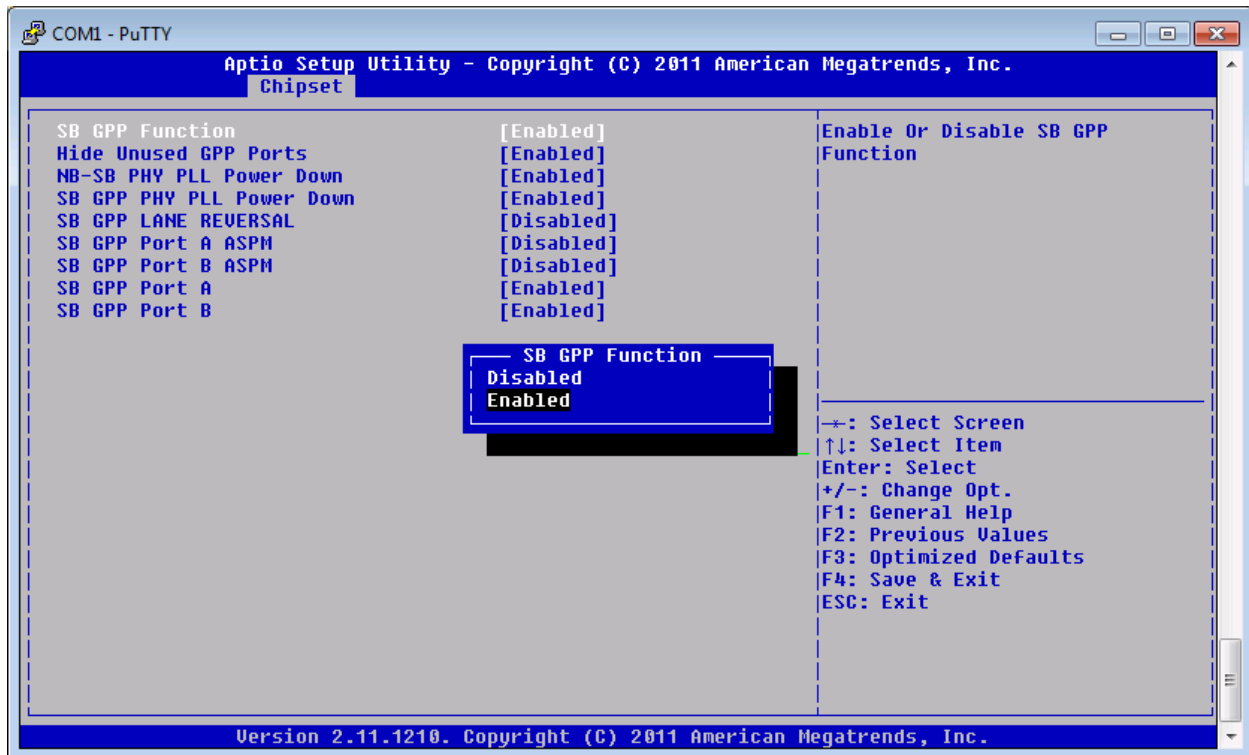

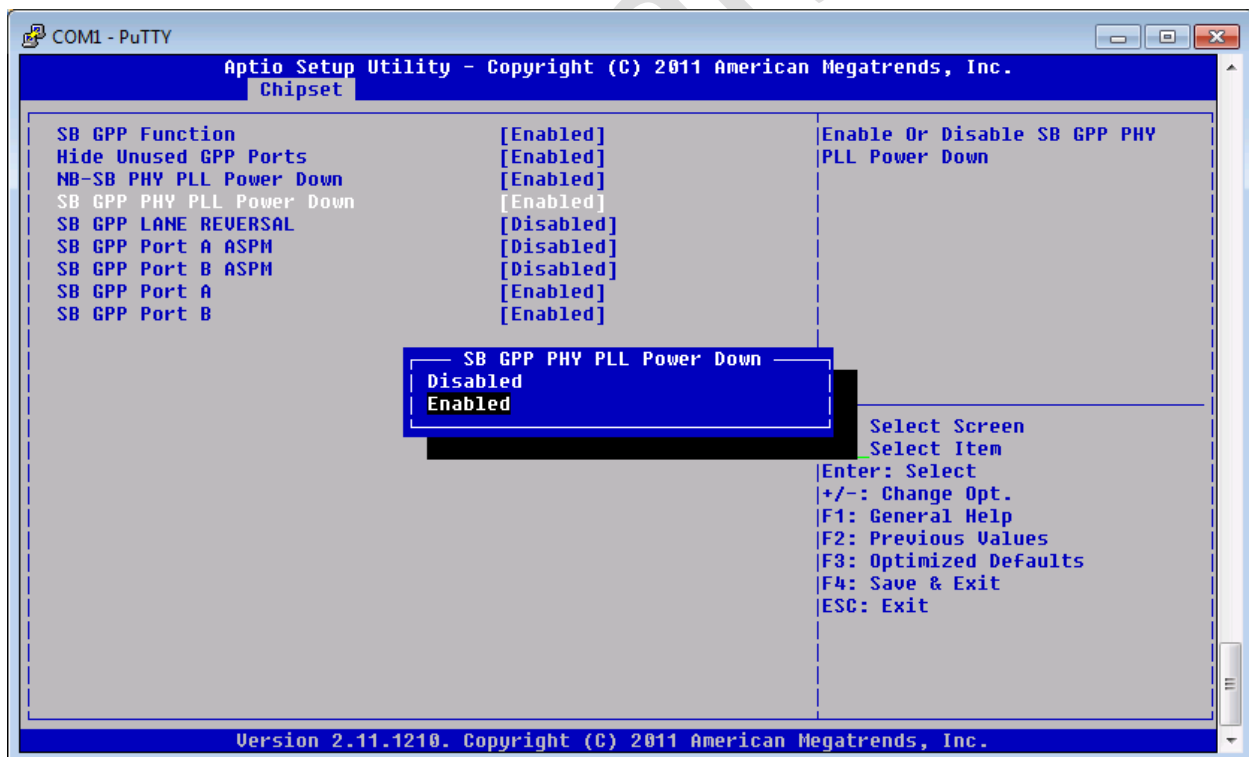
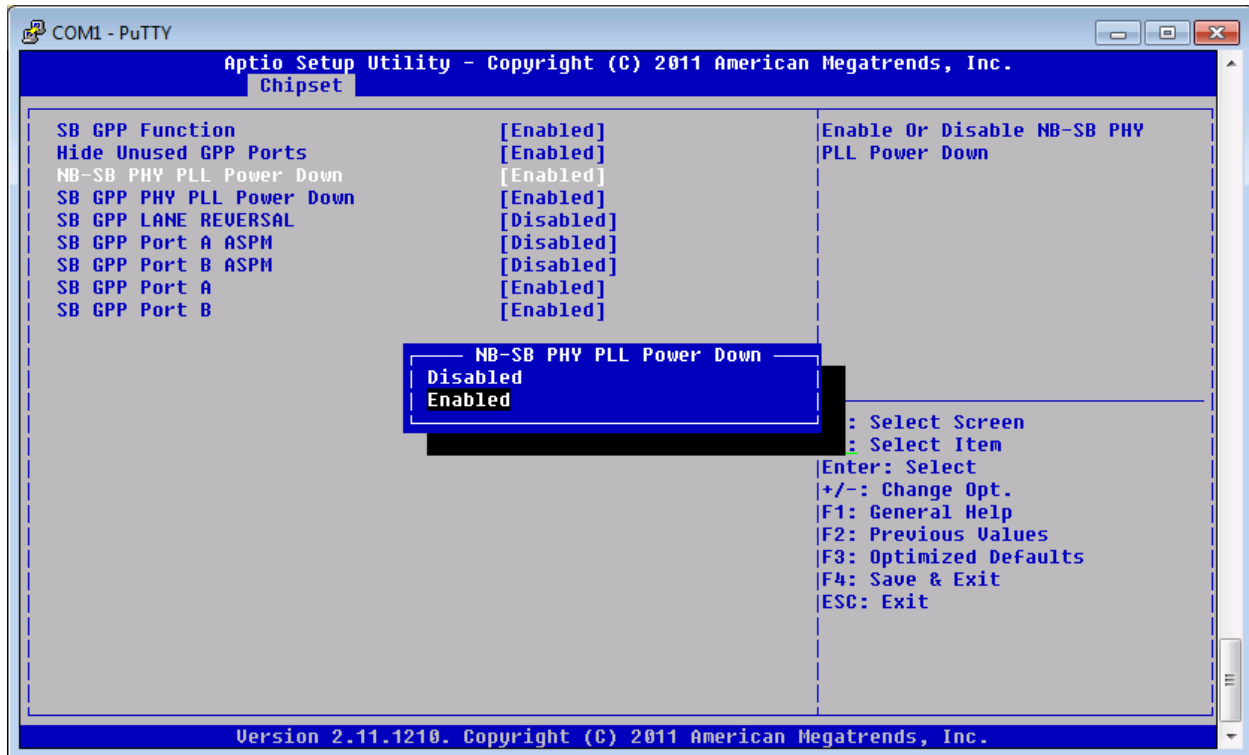

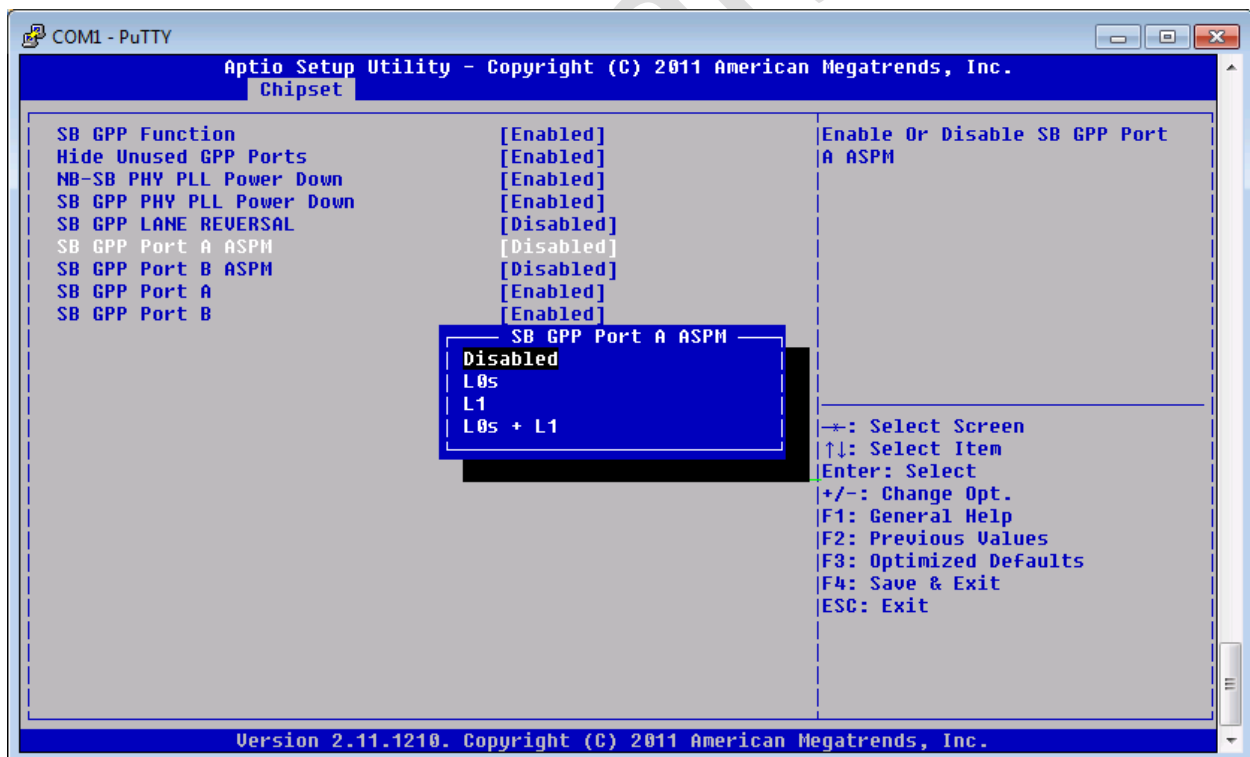
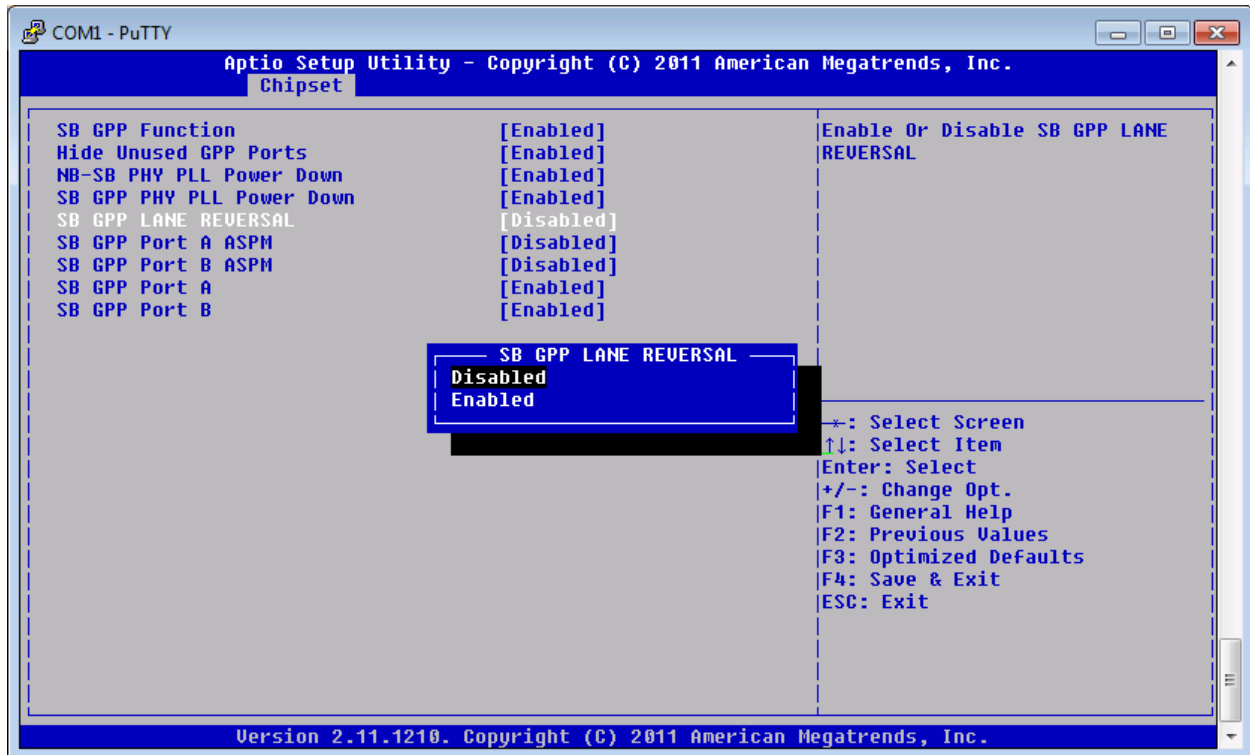

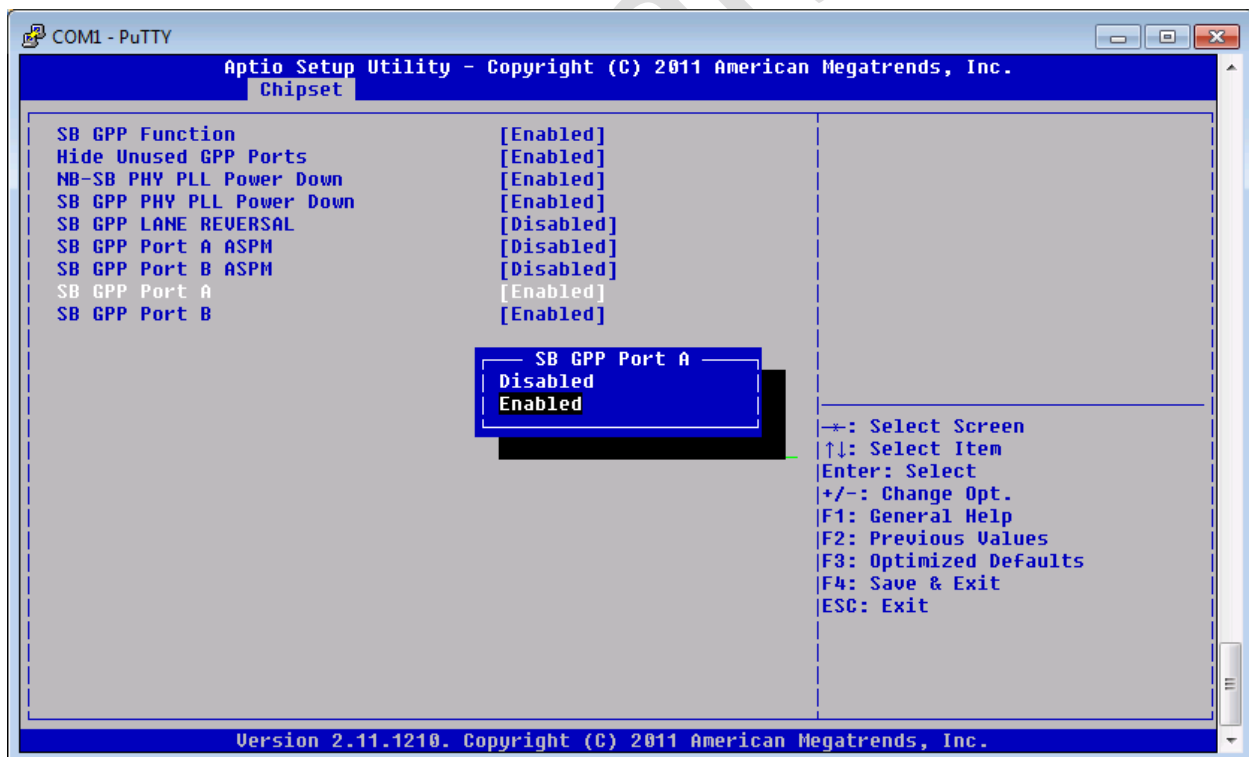
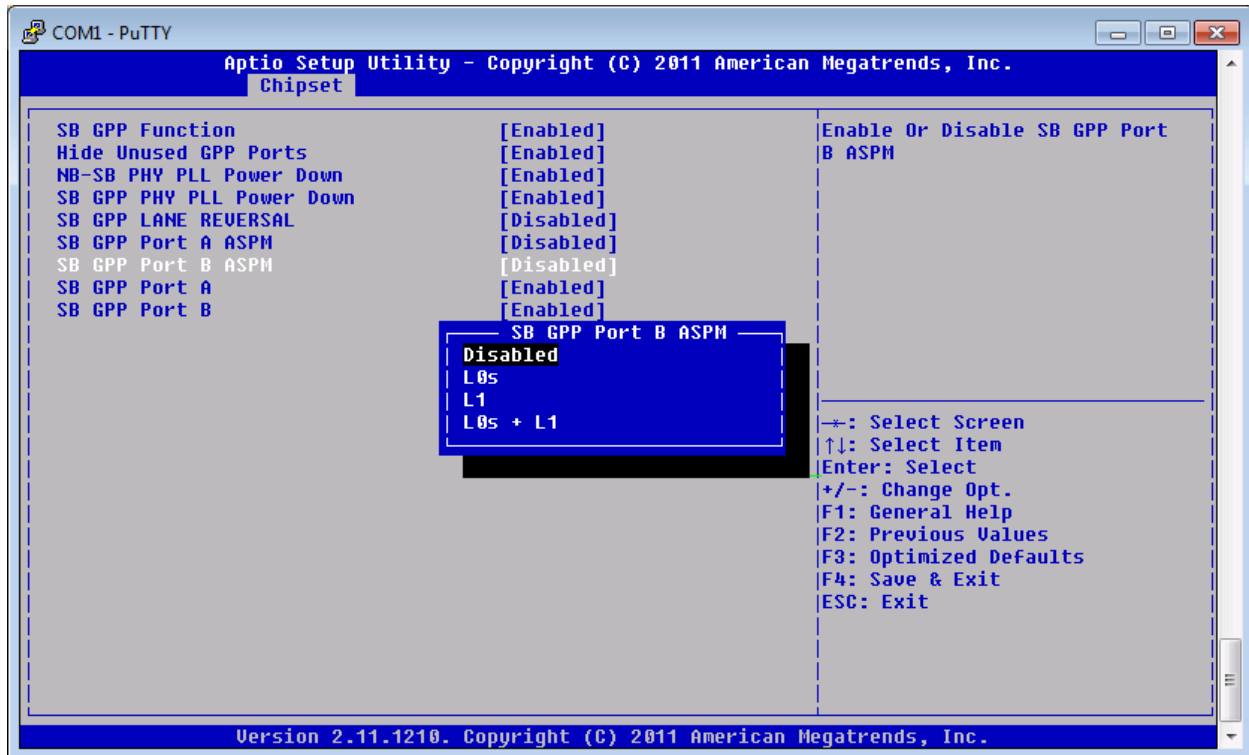

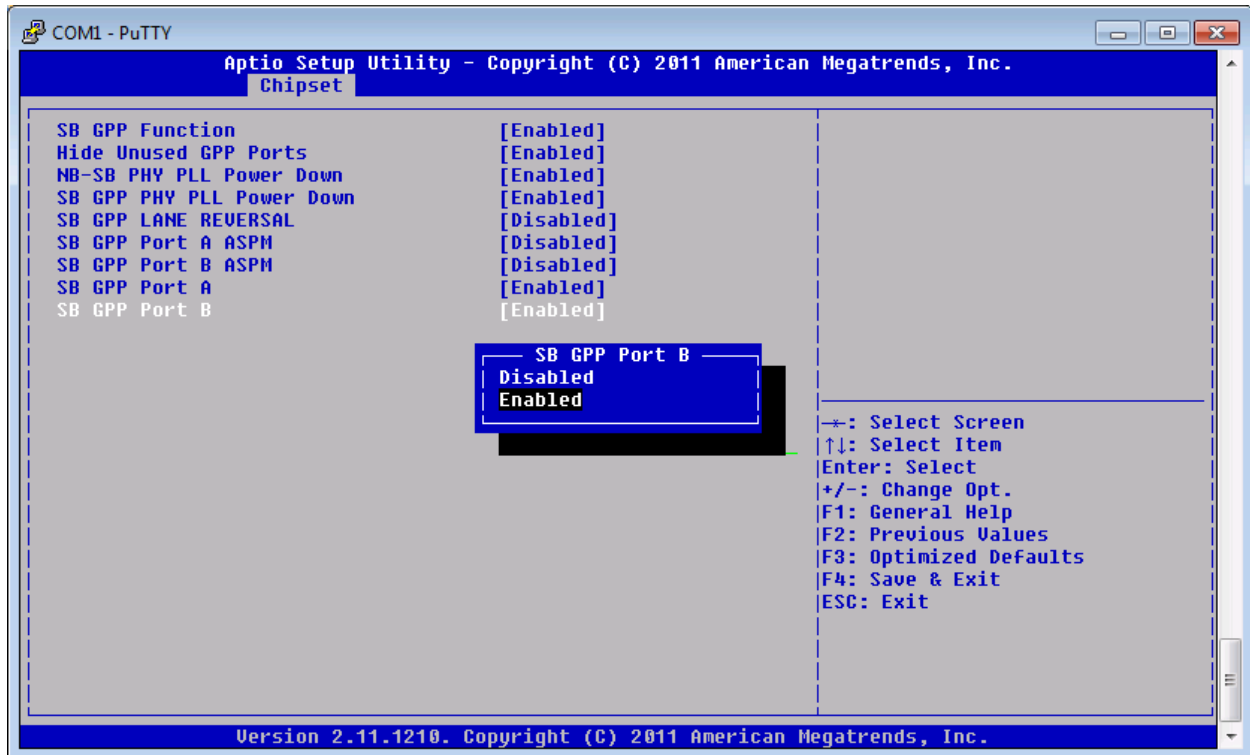

South Bridge HD Azalia Configuration

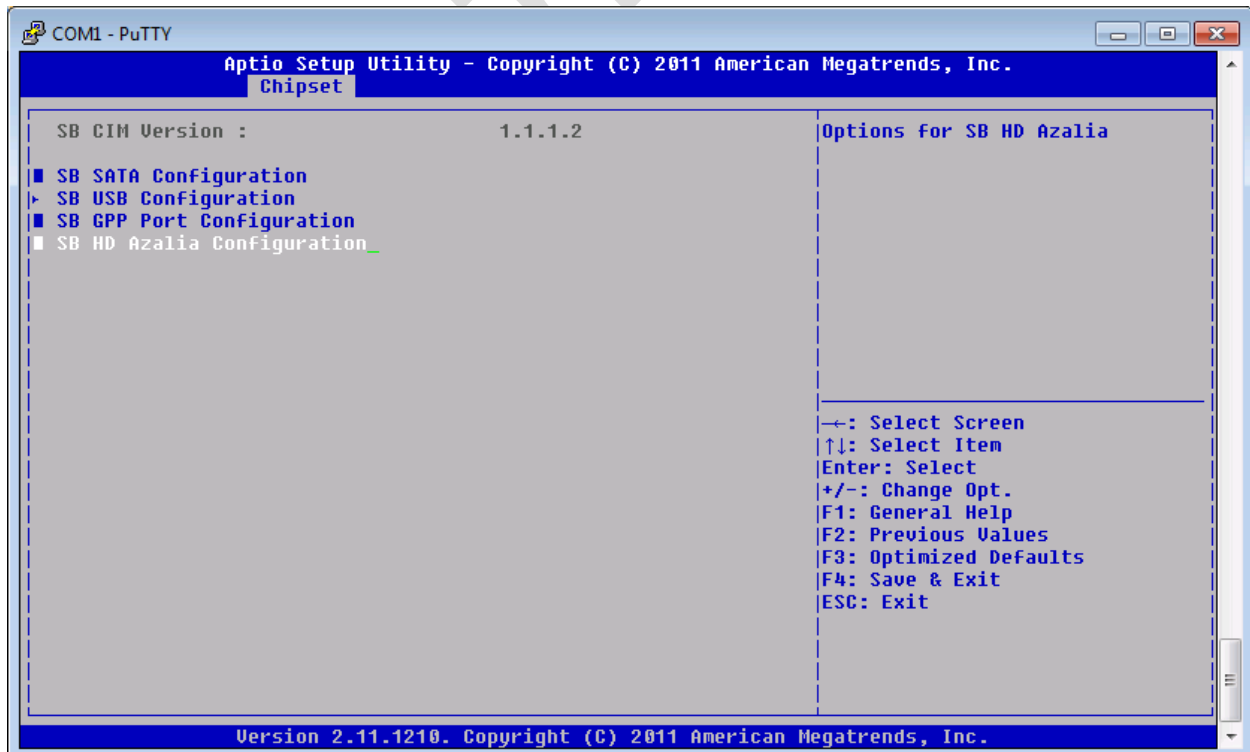

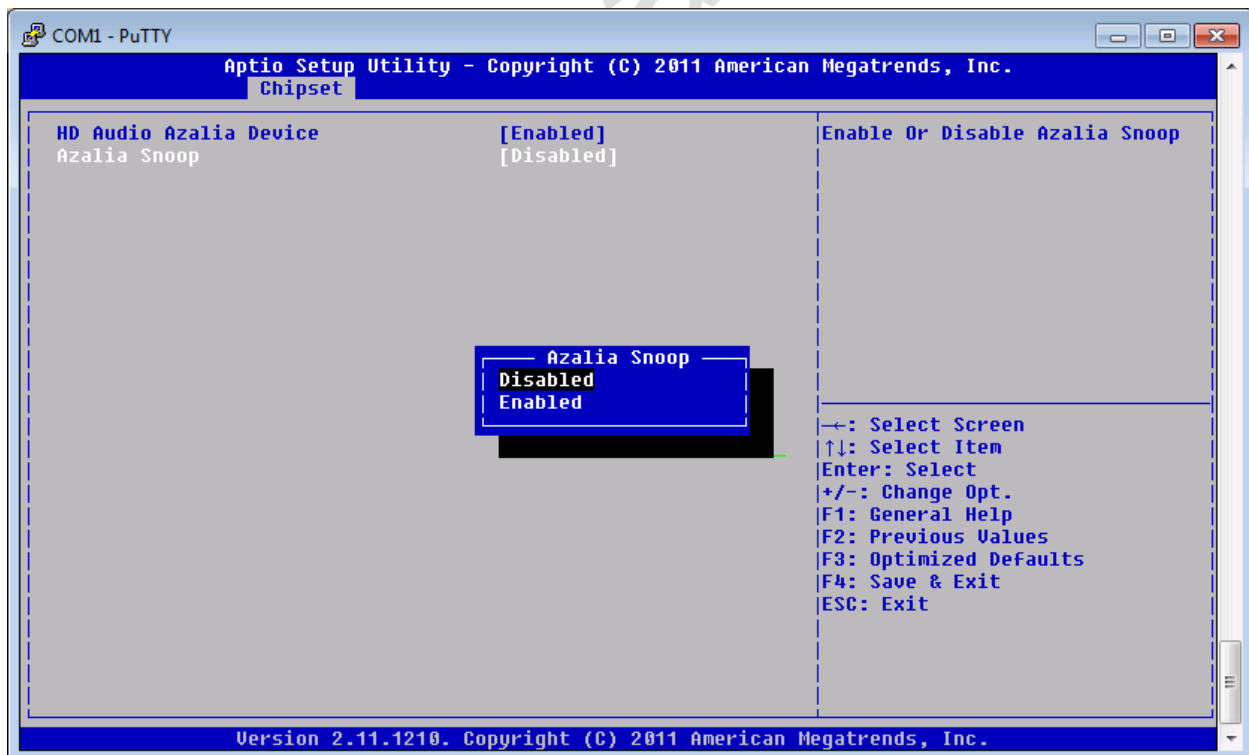
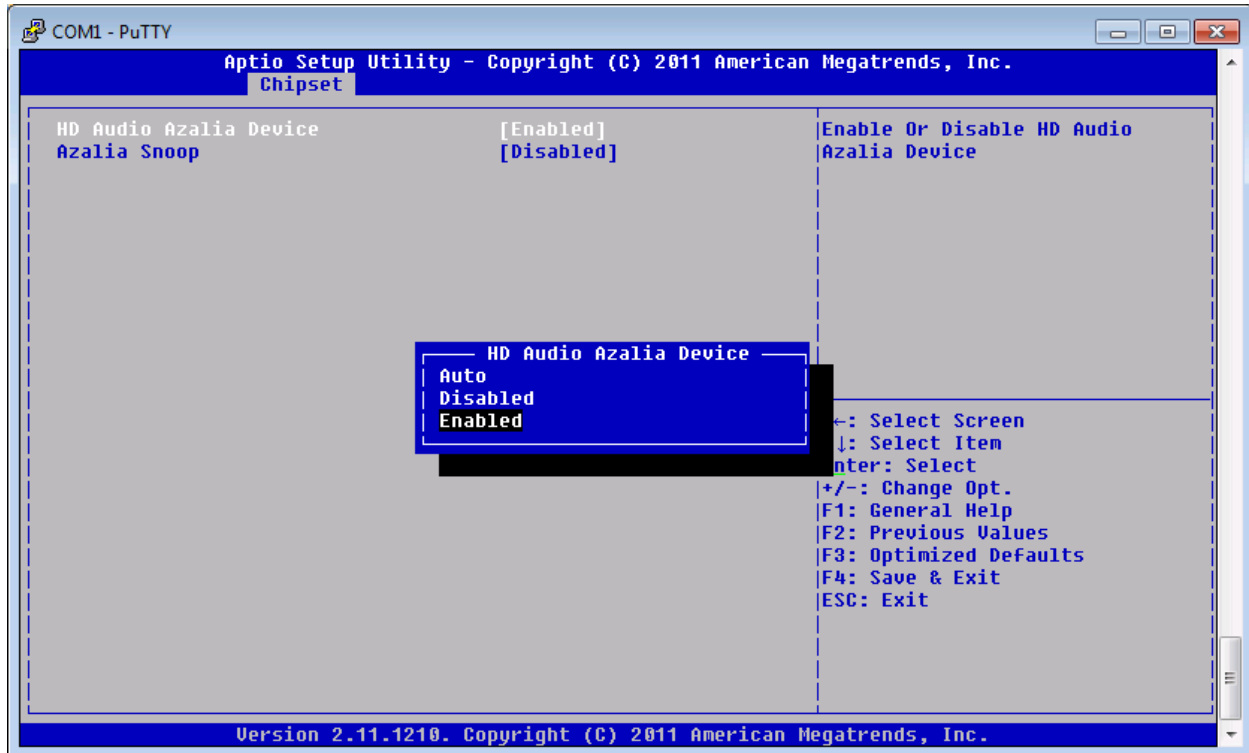

8.3.5 Boot Configuration

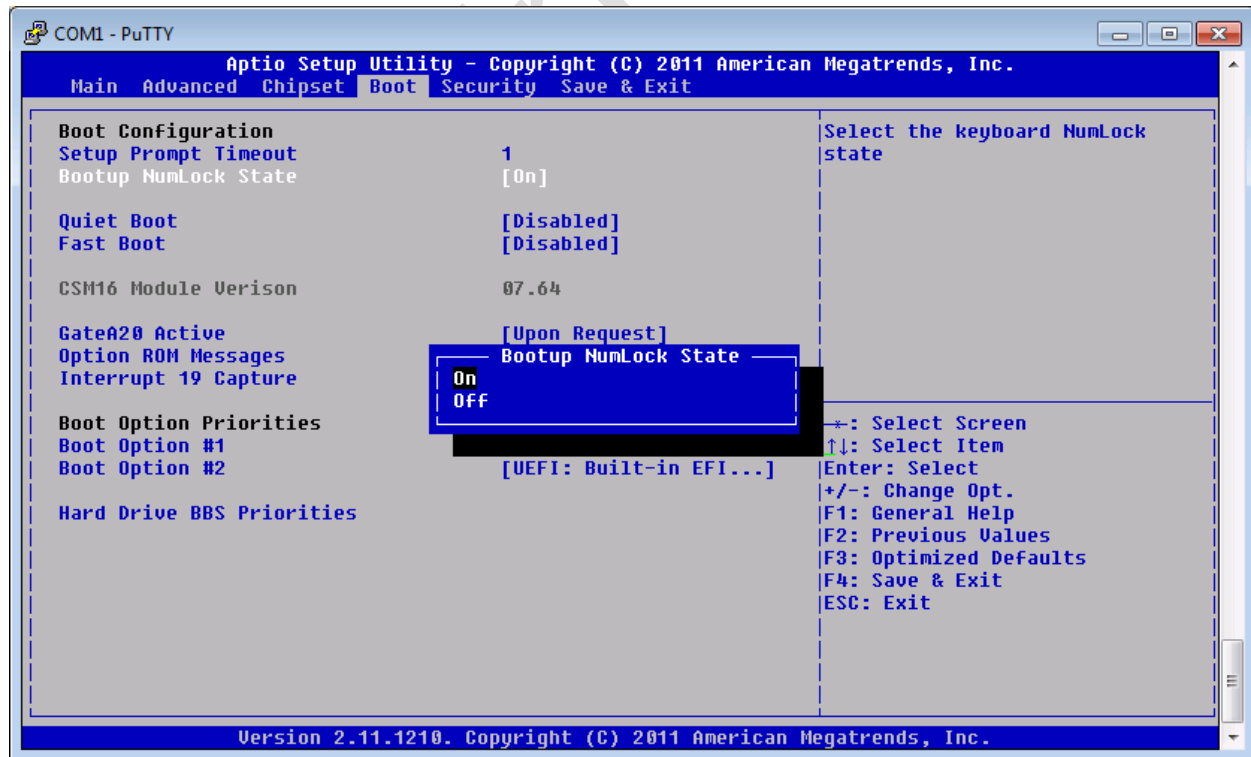
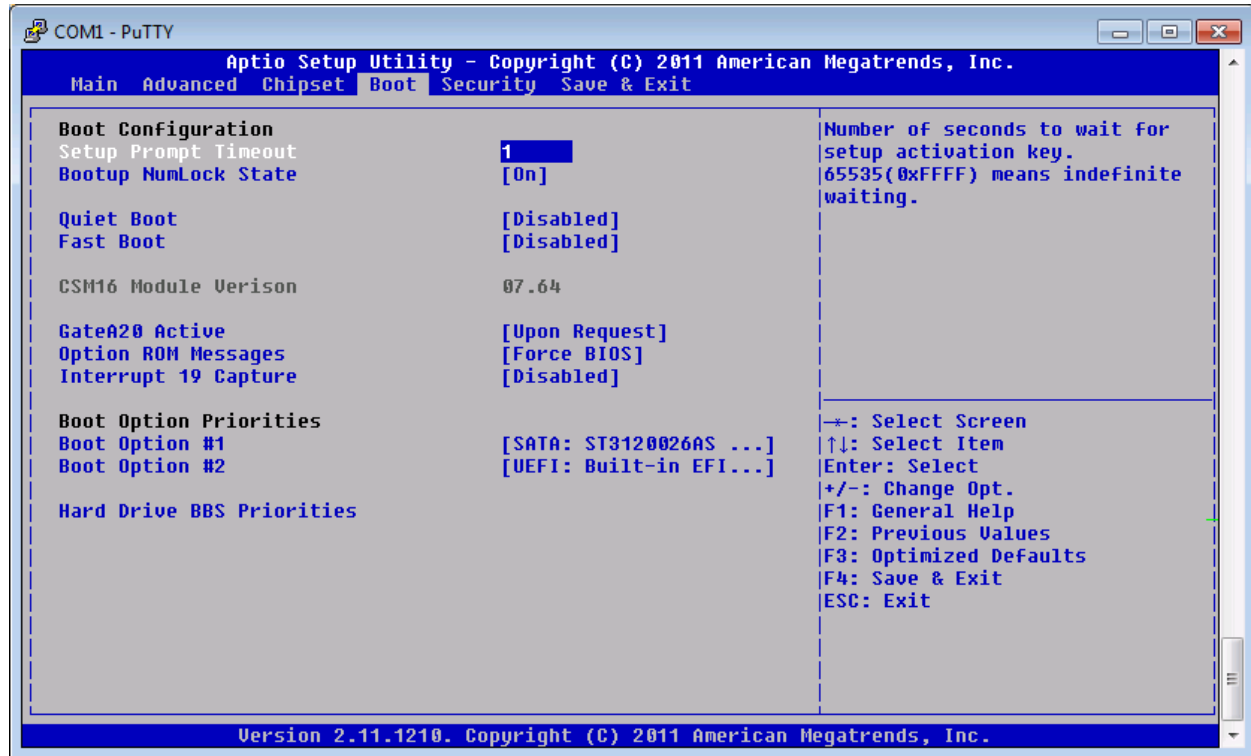

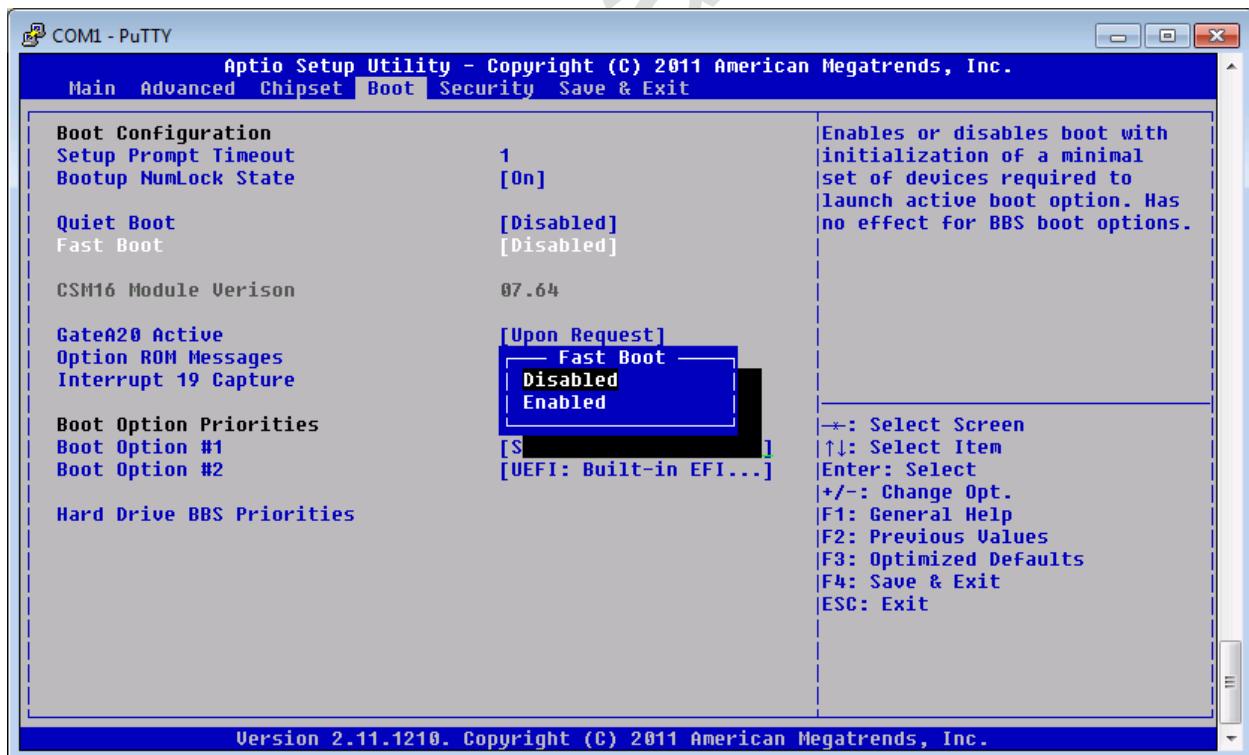
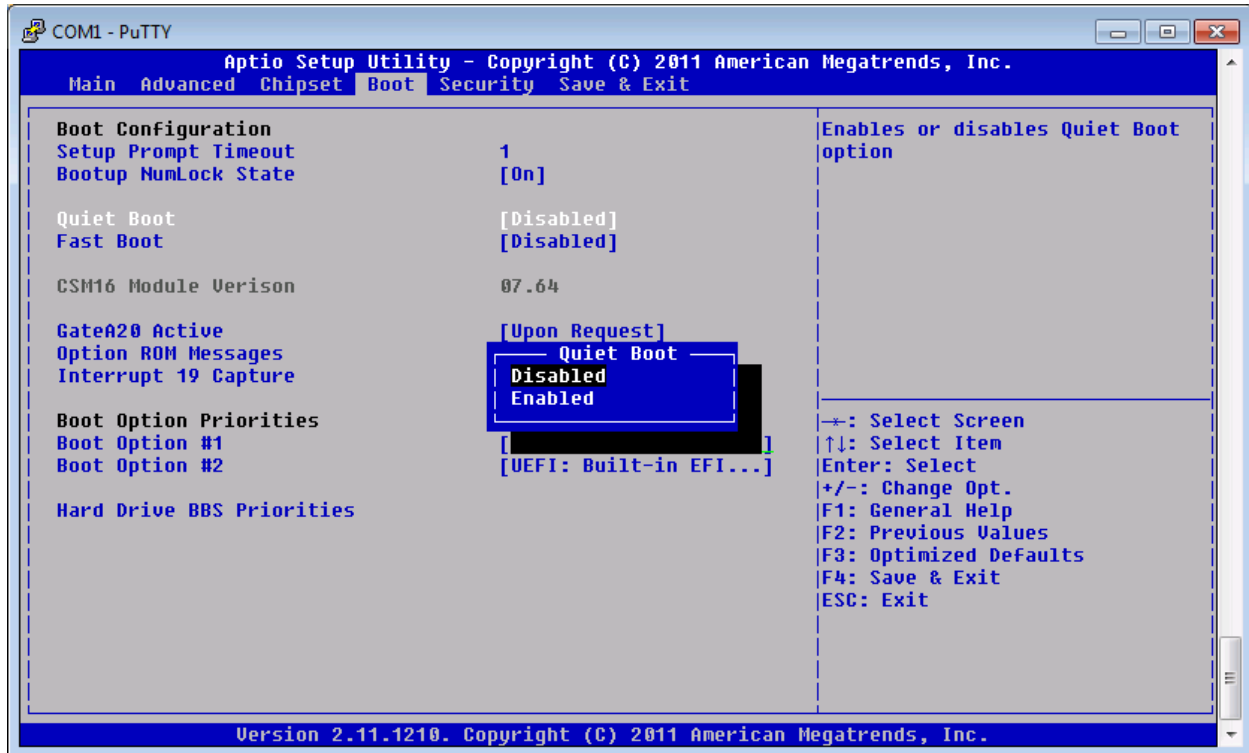

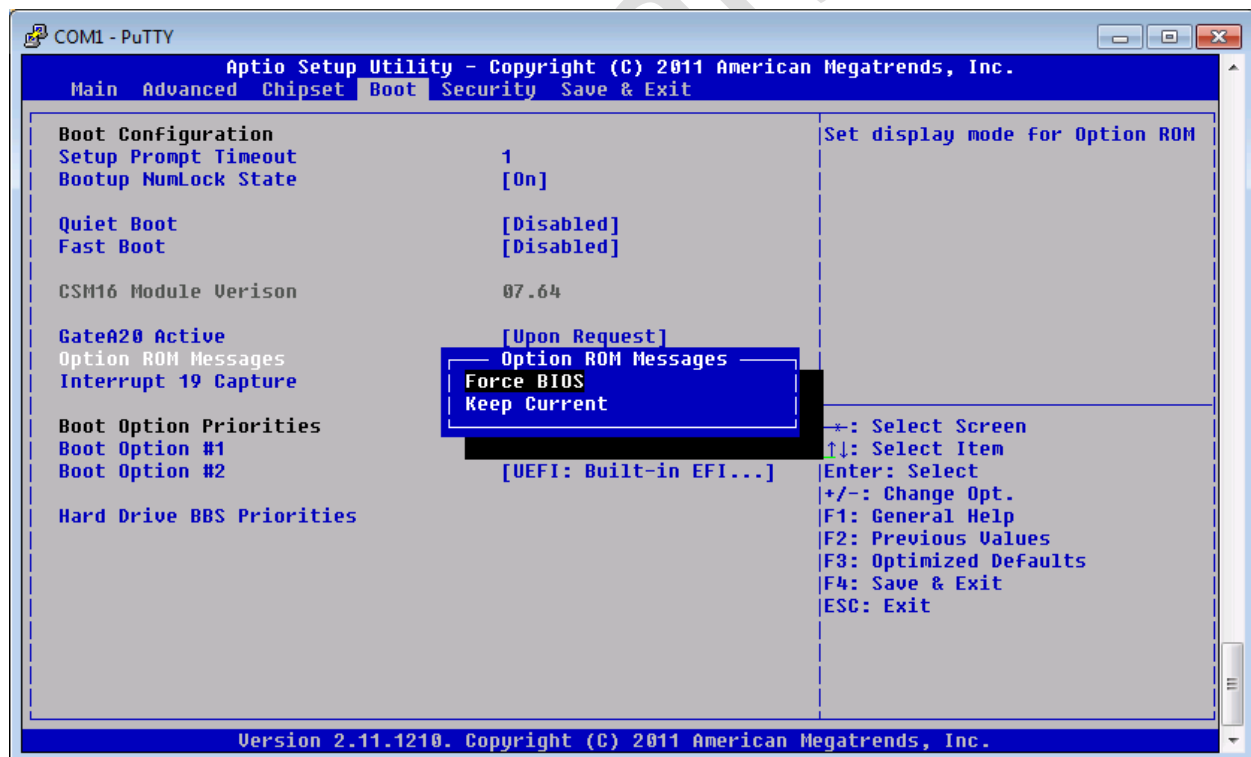
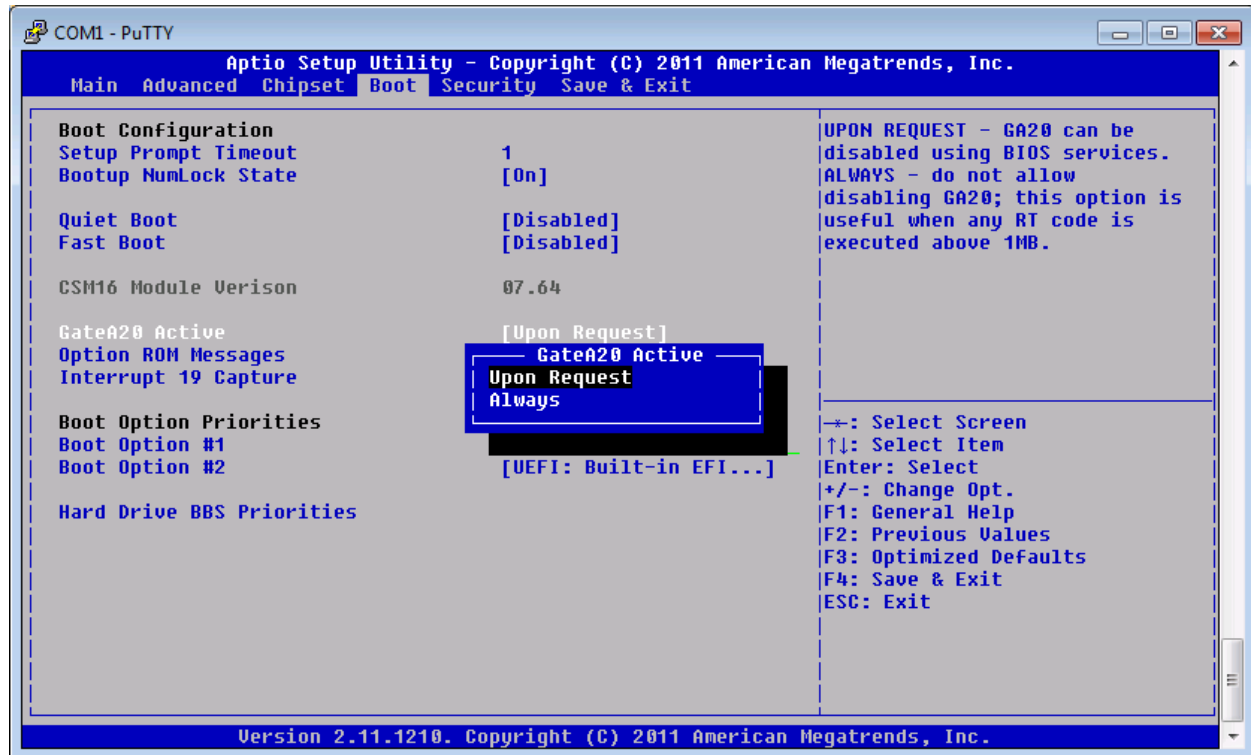

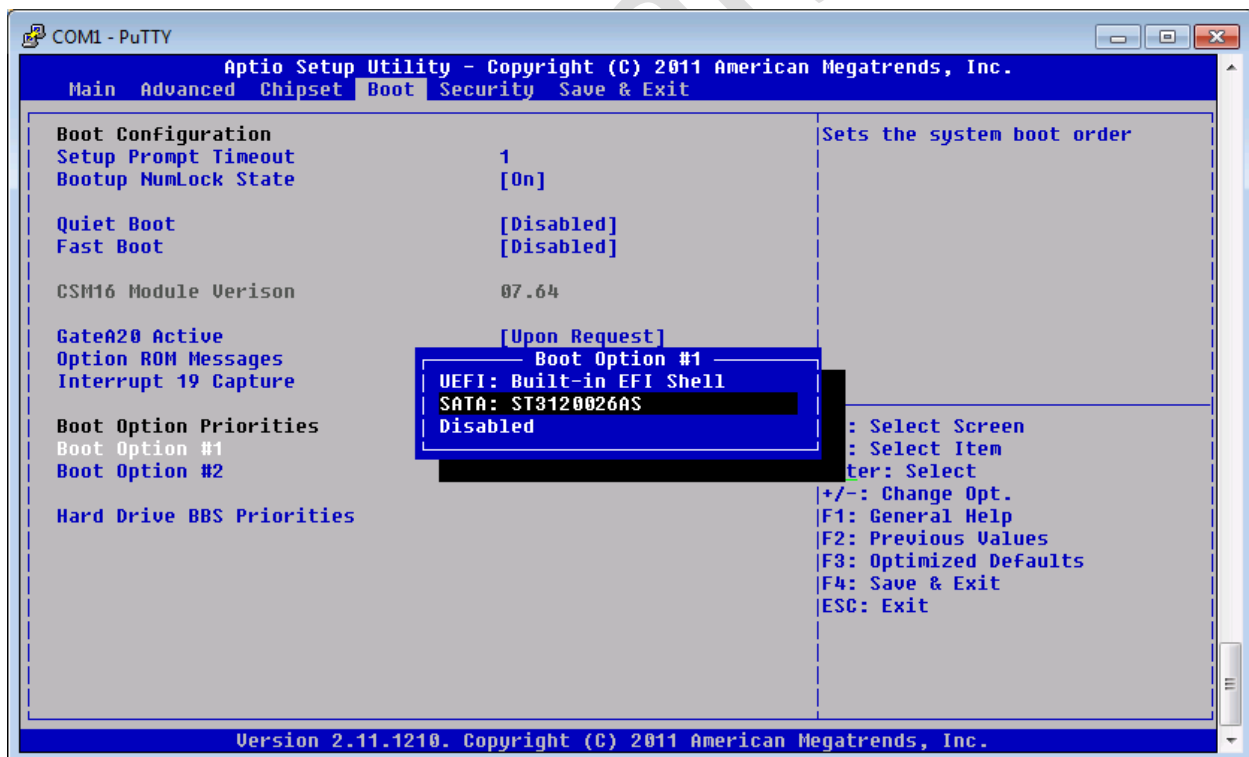
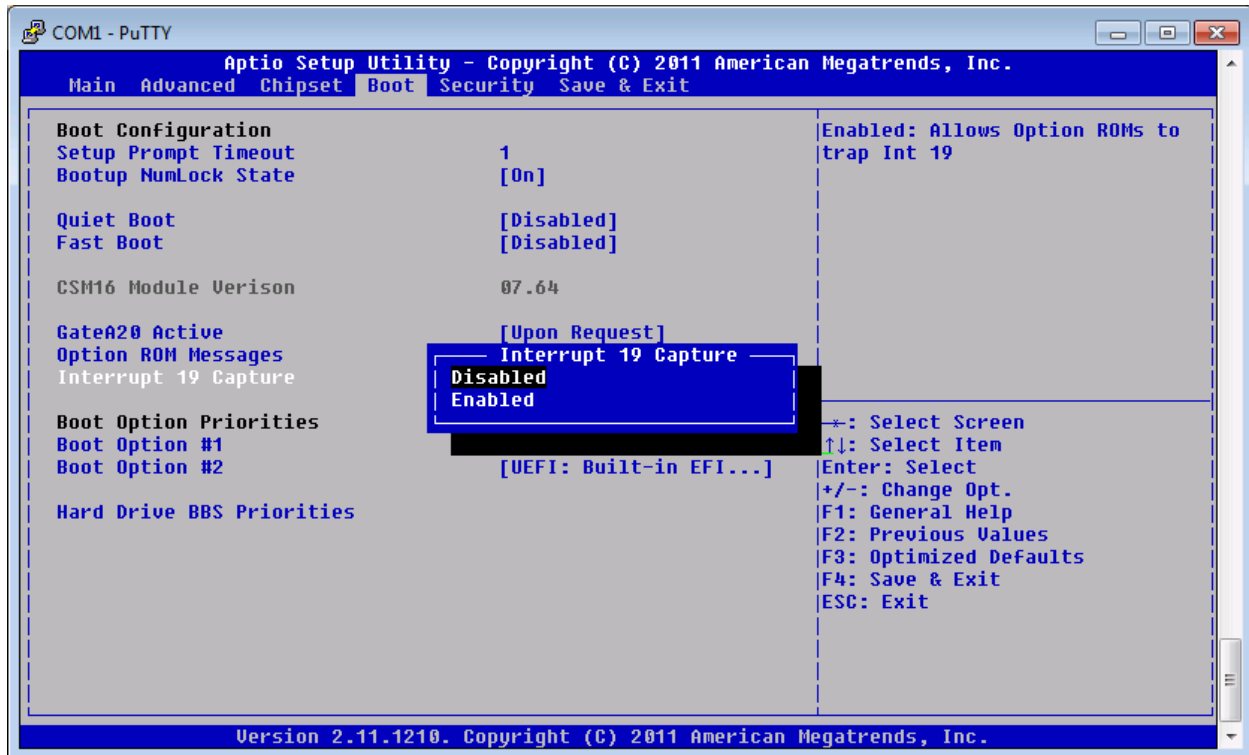

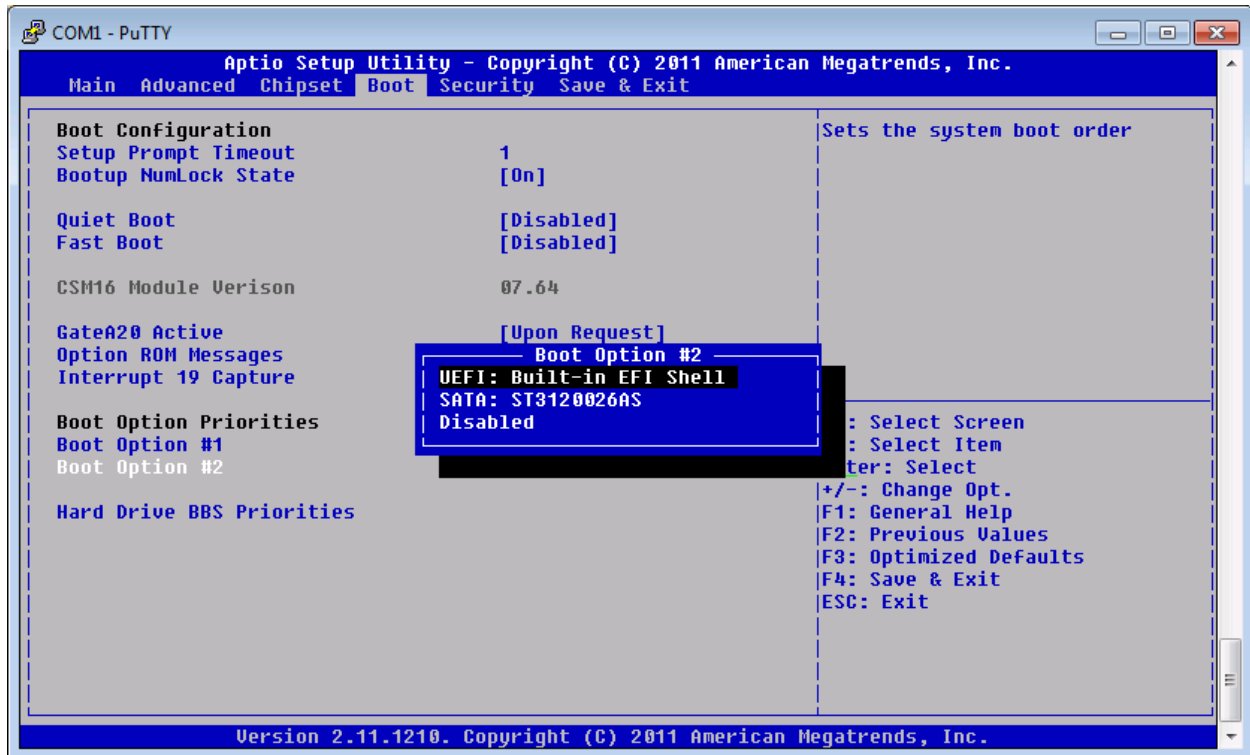

Hard Drive BBS Priorities

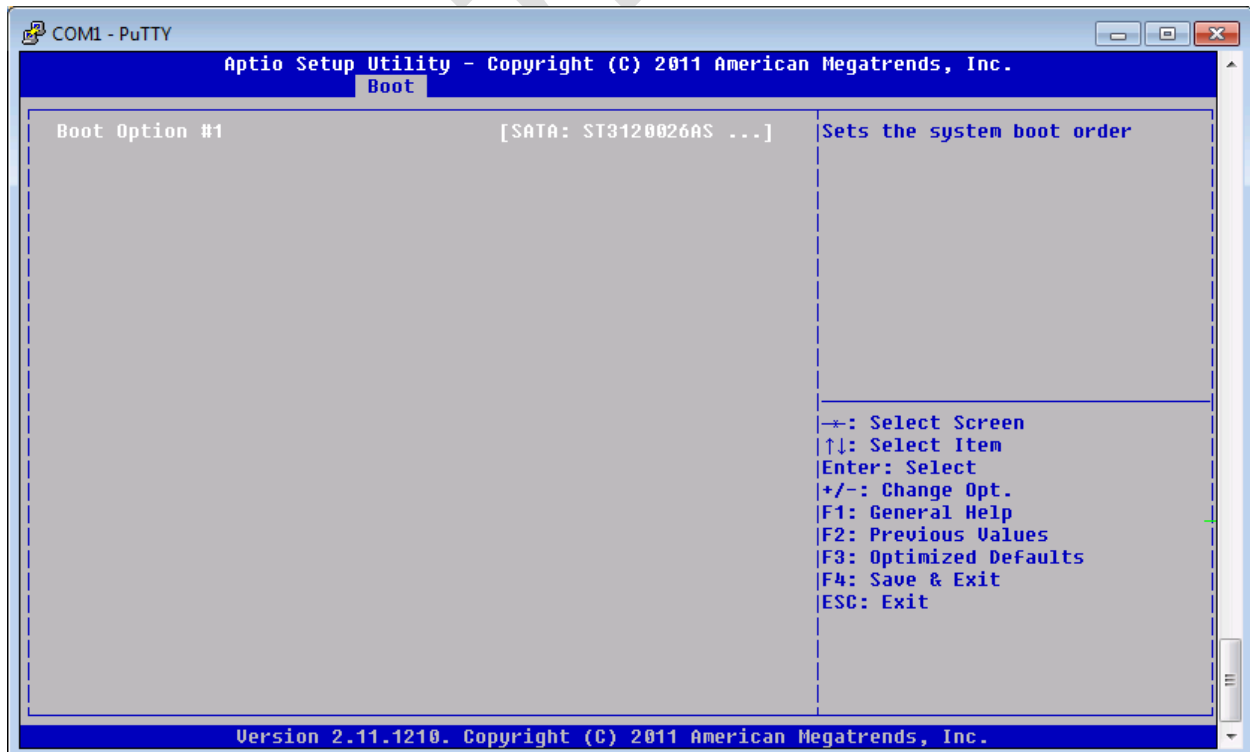

8.3.6 Security

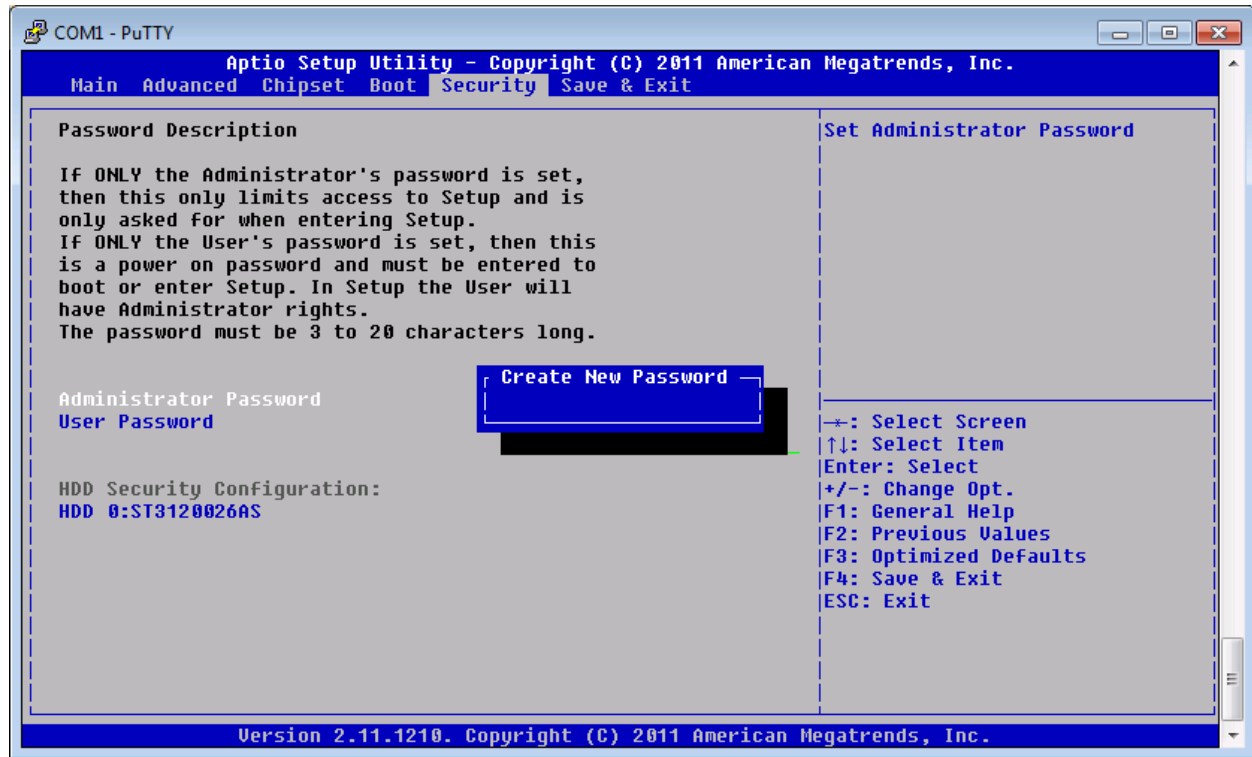

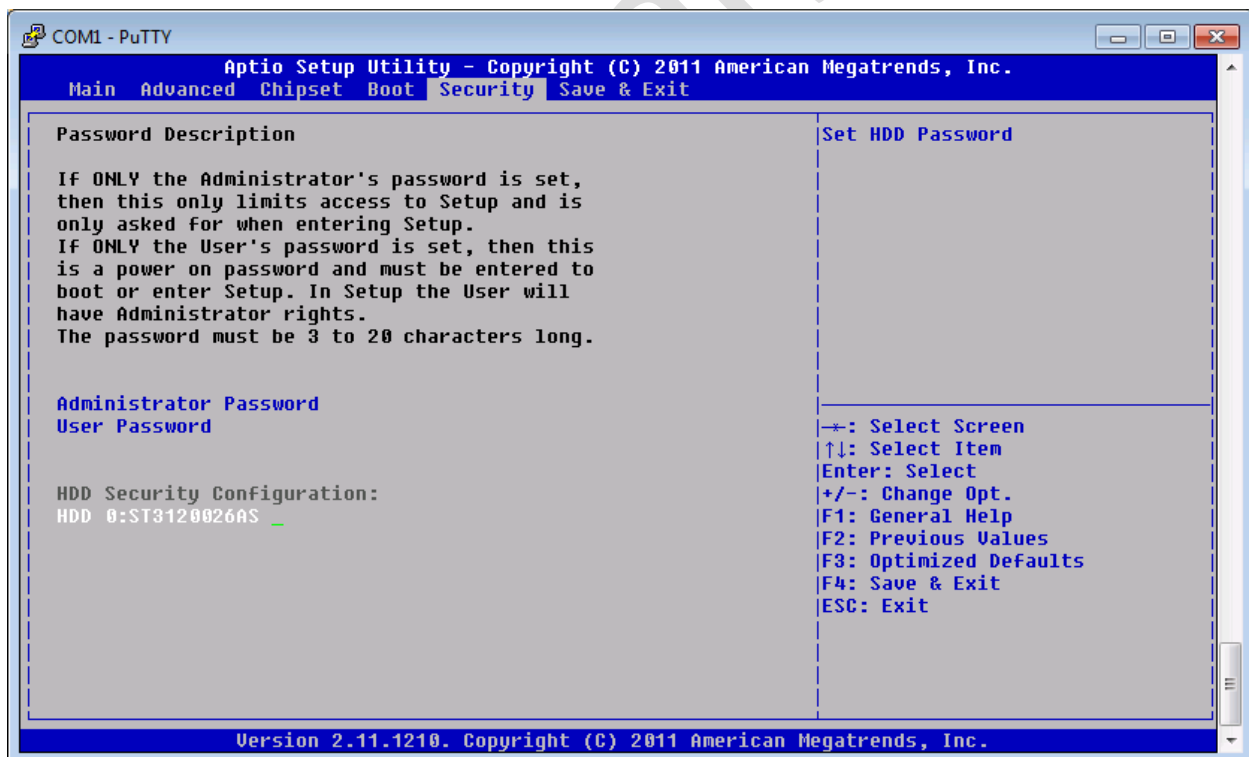
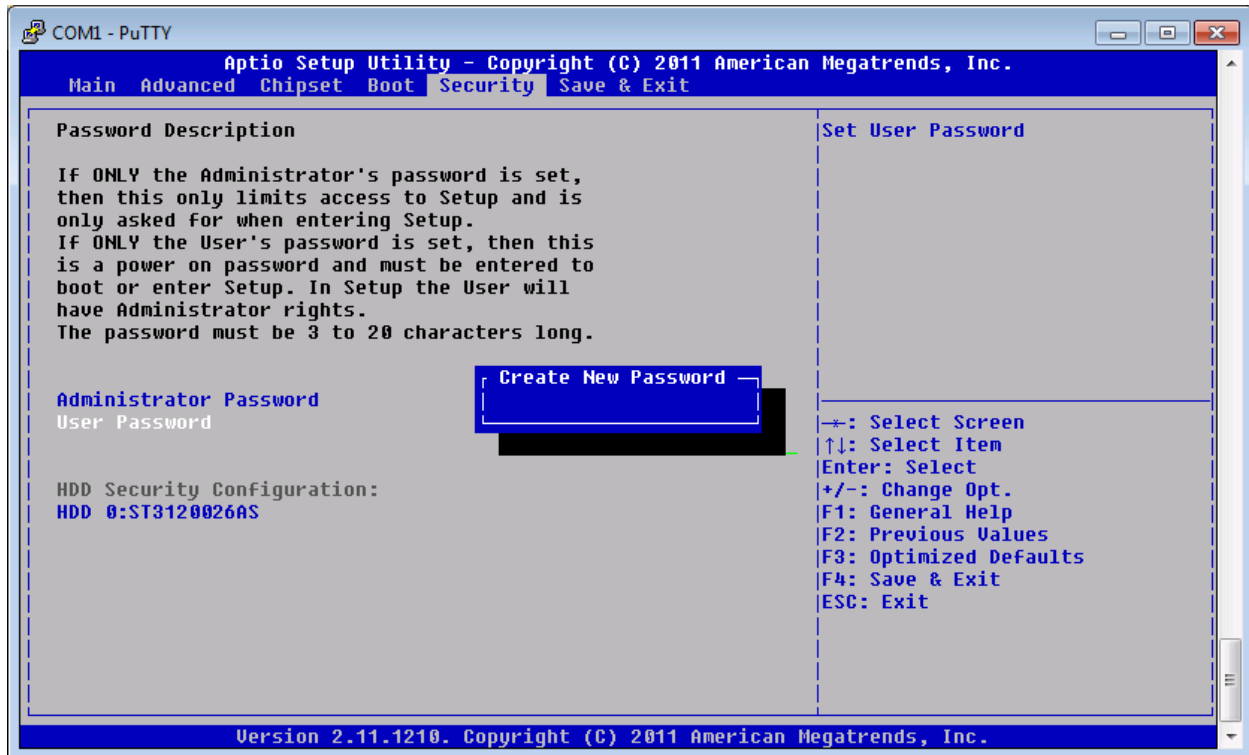

HDD Security Configuration

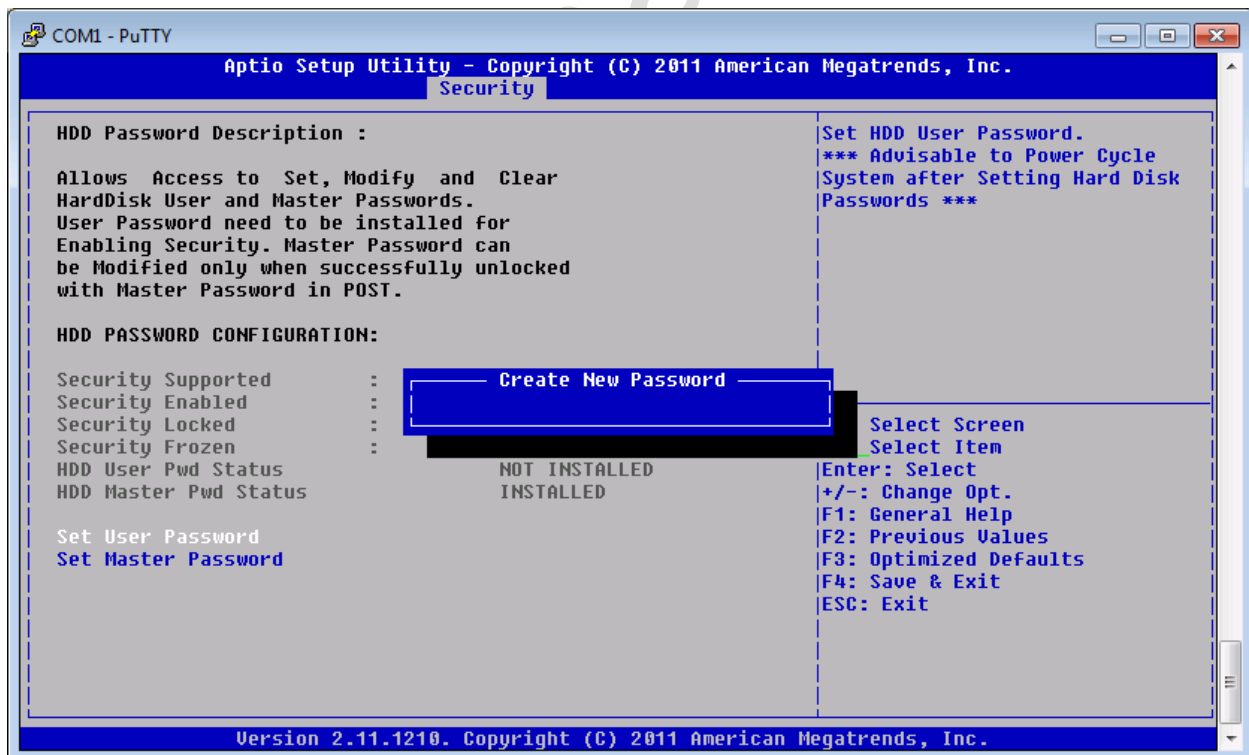
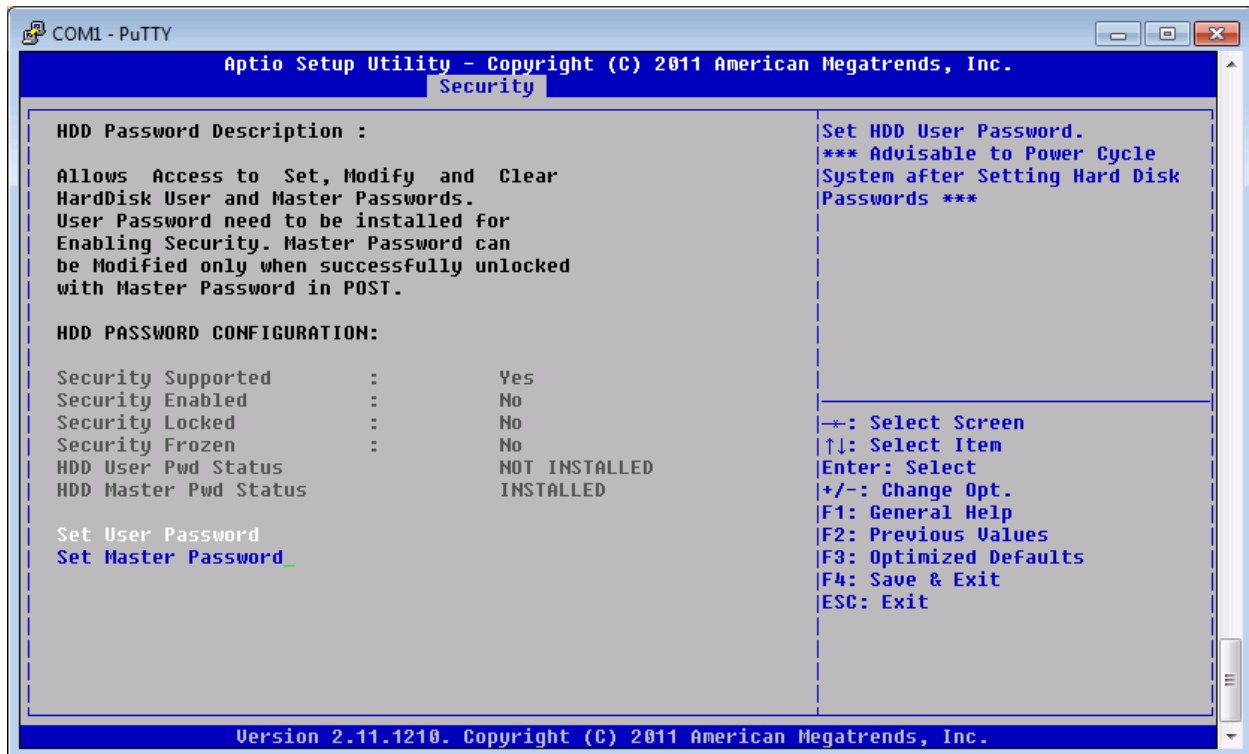

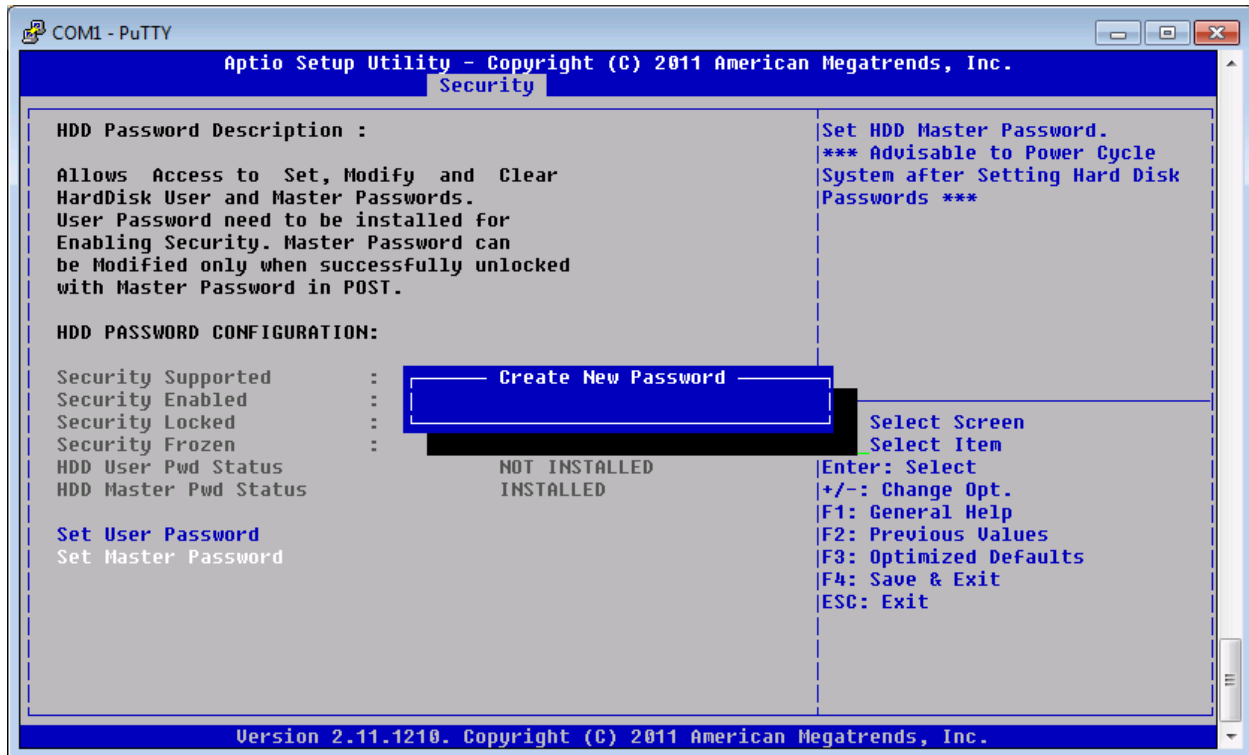

8.3.7 Save and Exit

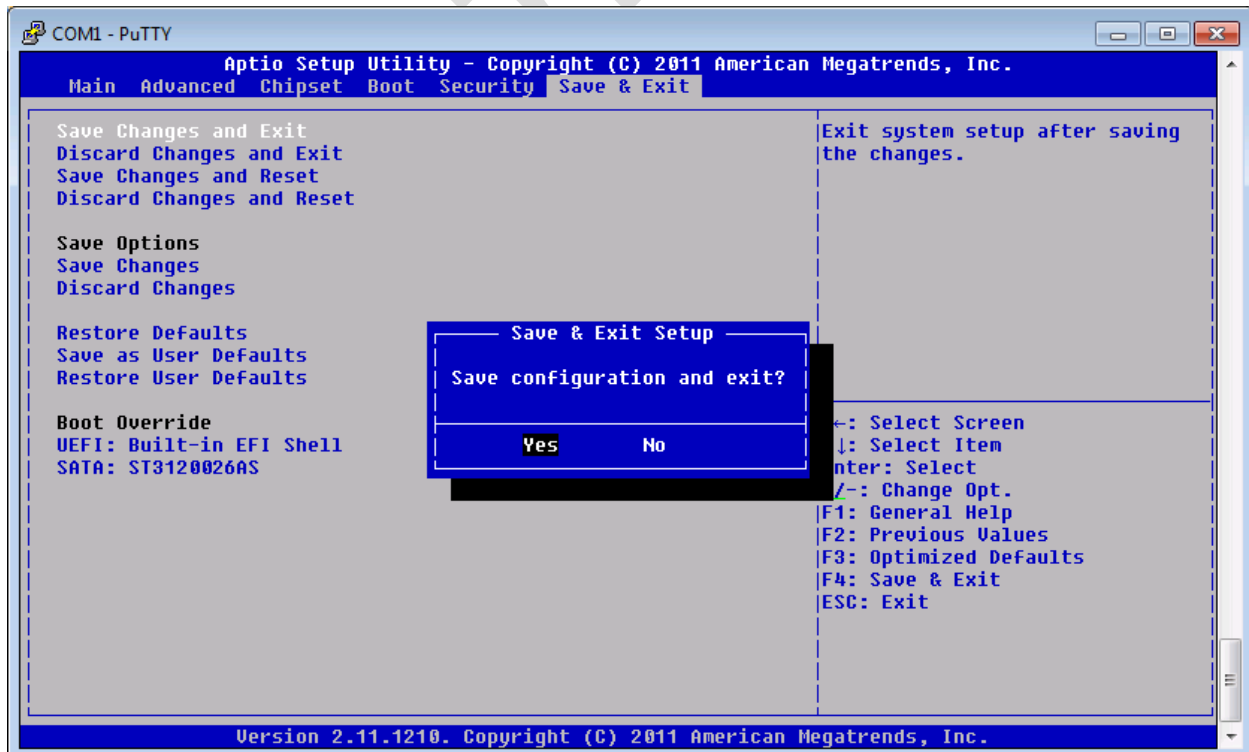

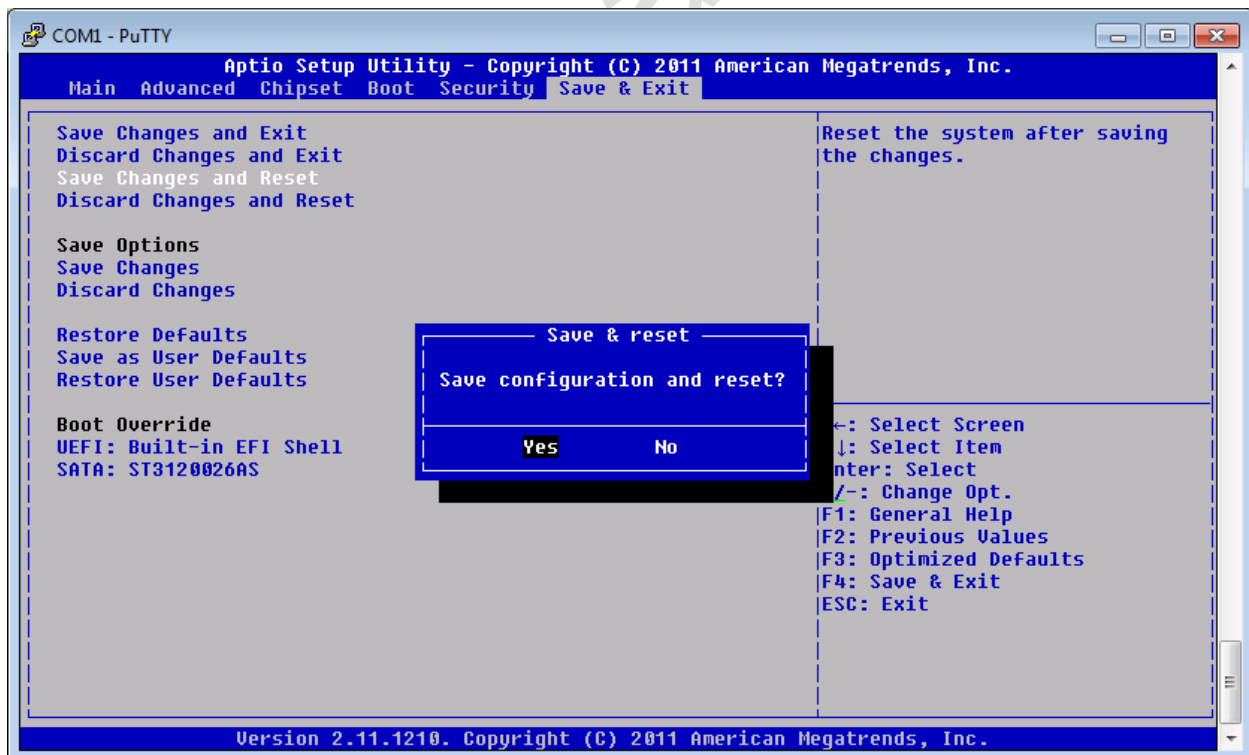
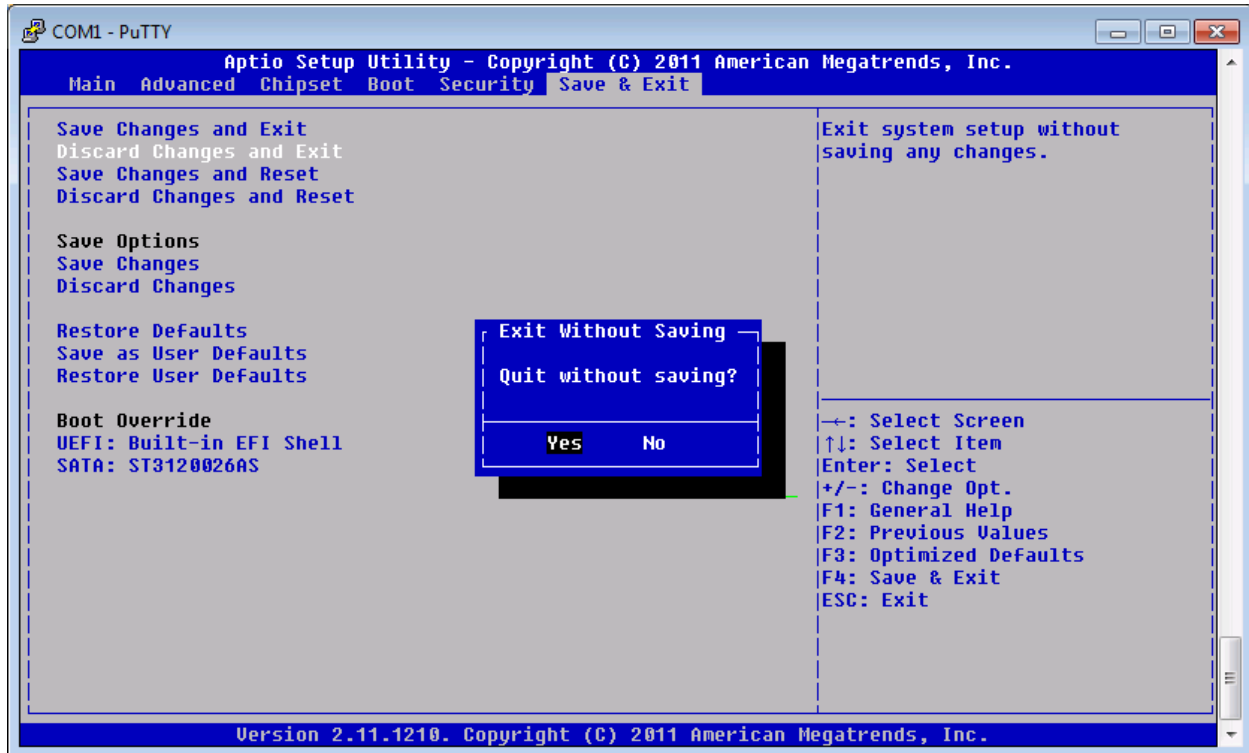

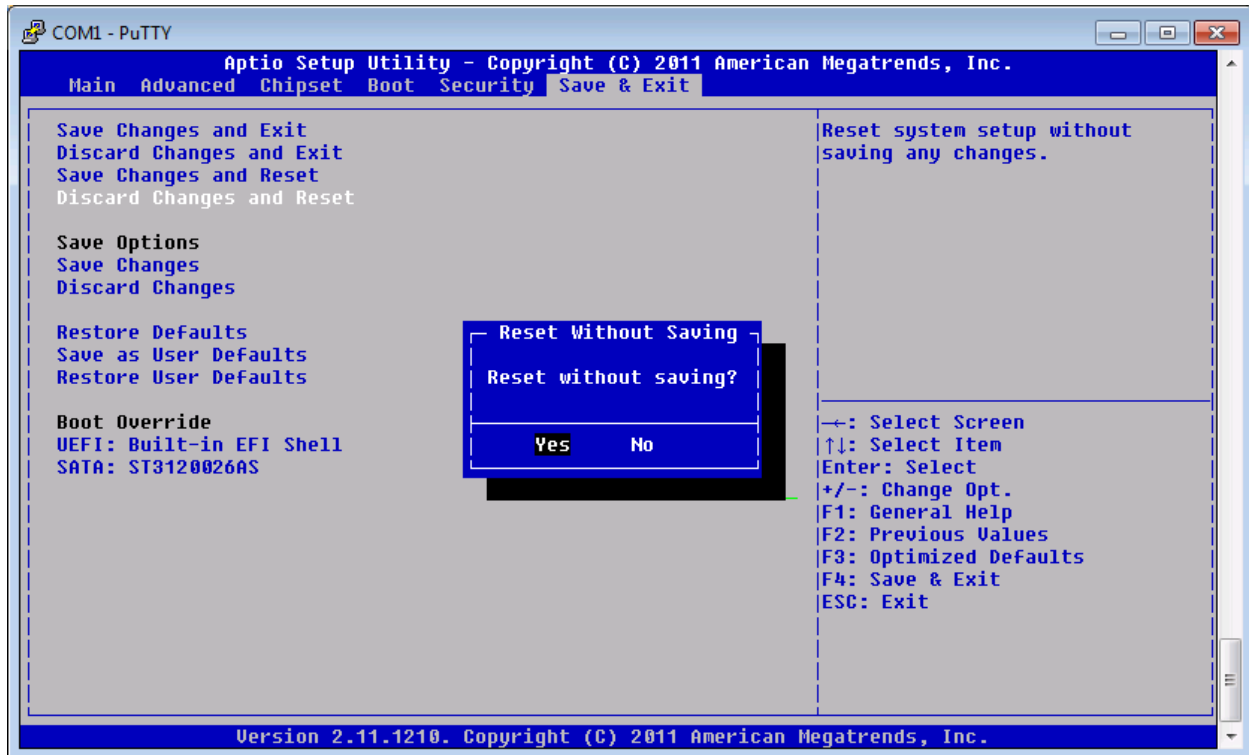

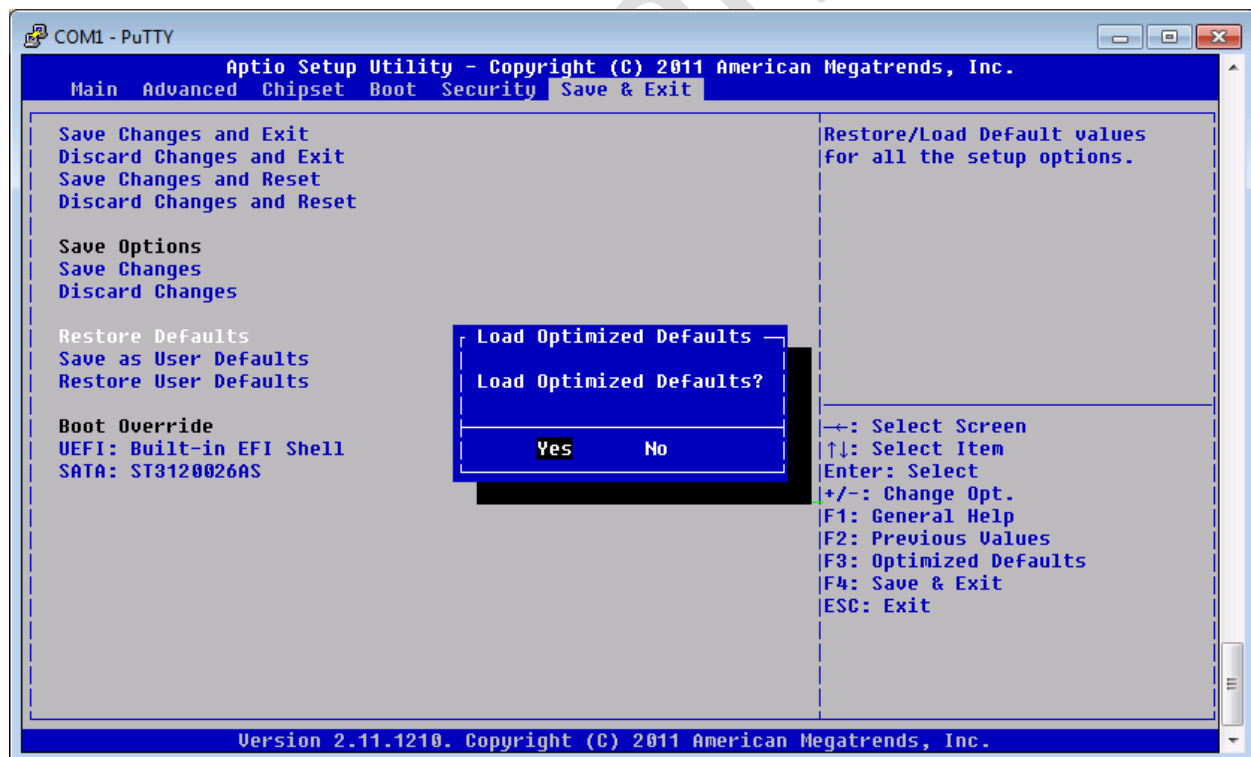
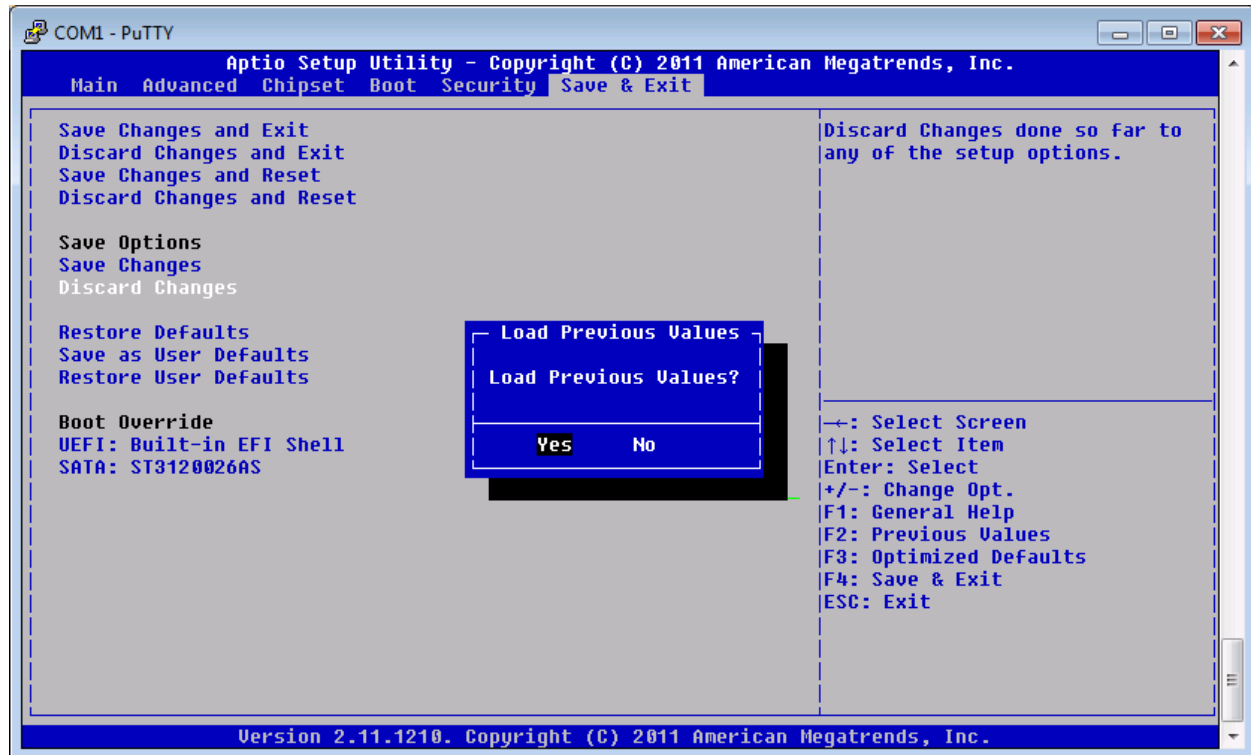

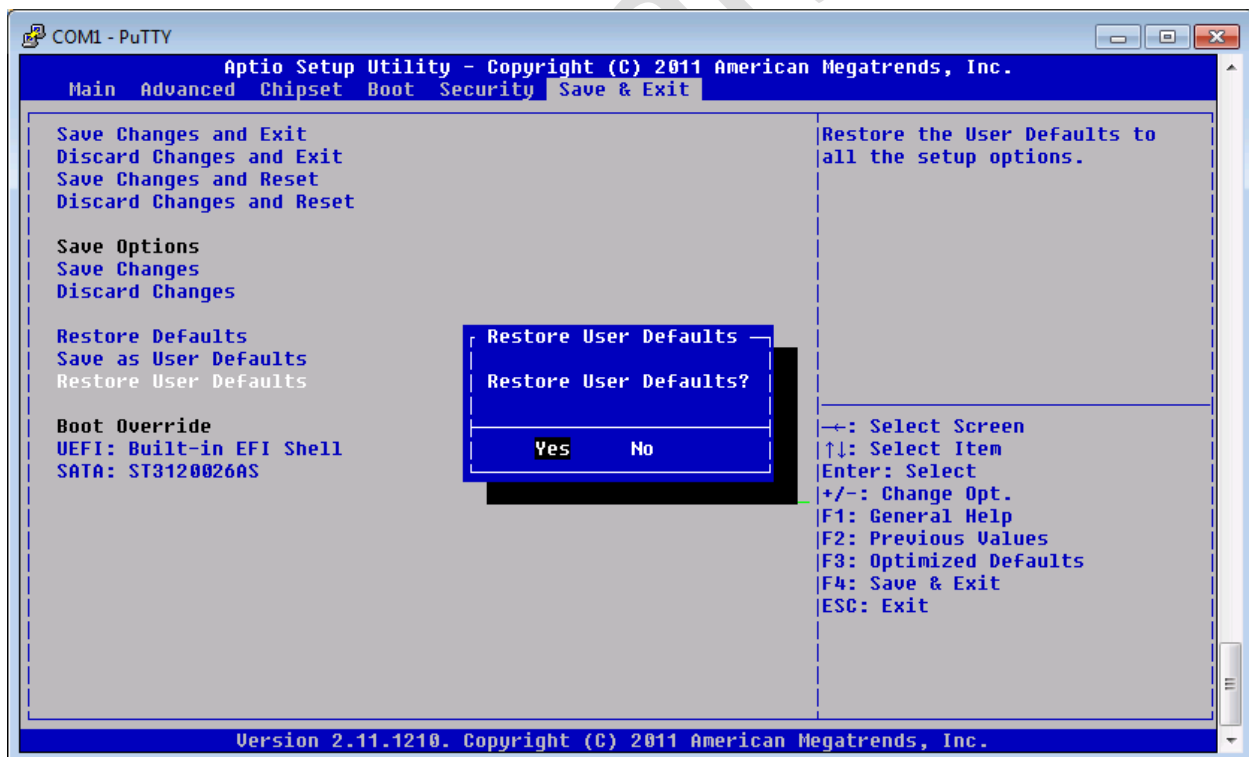
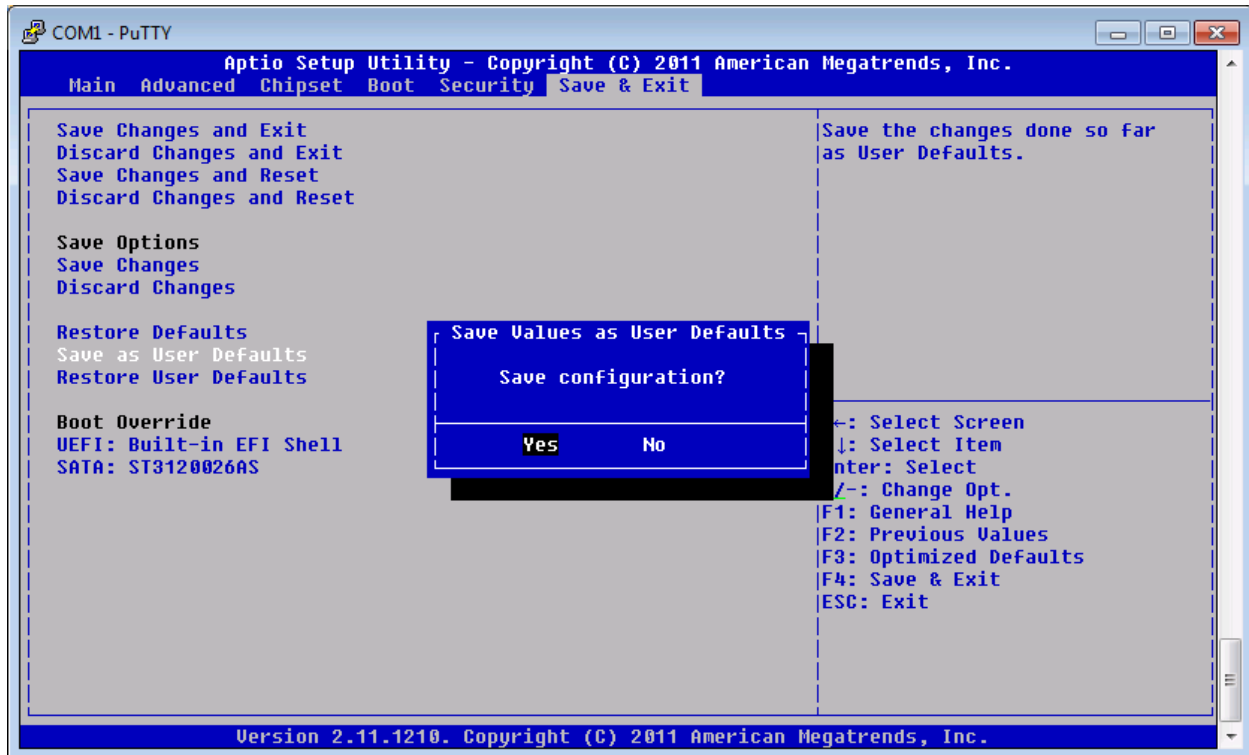

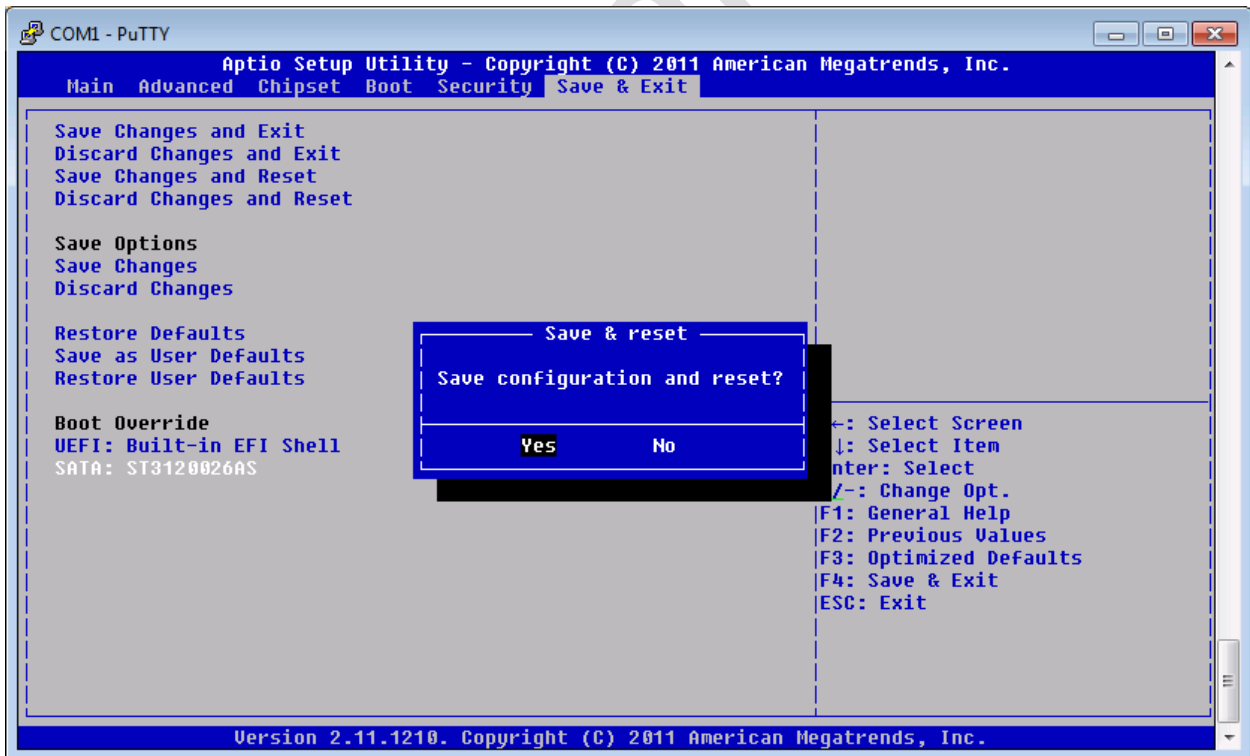
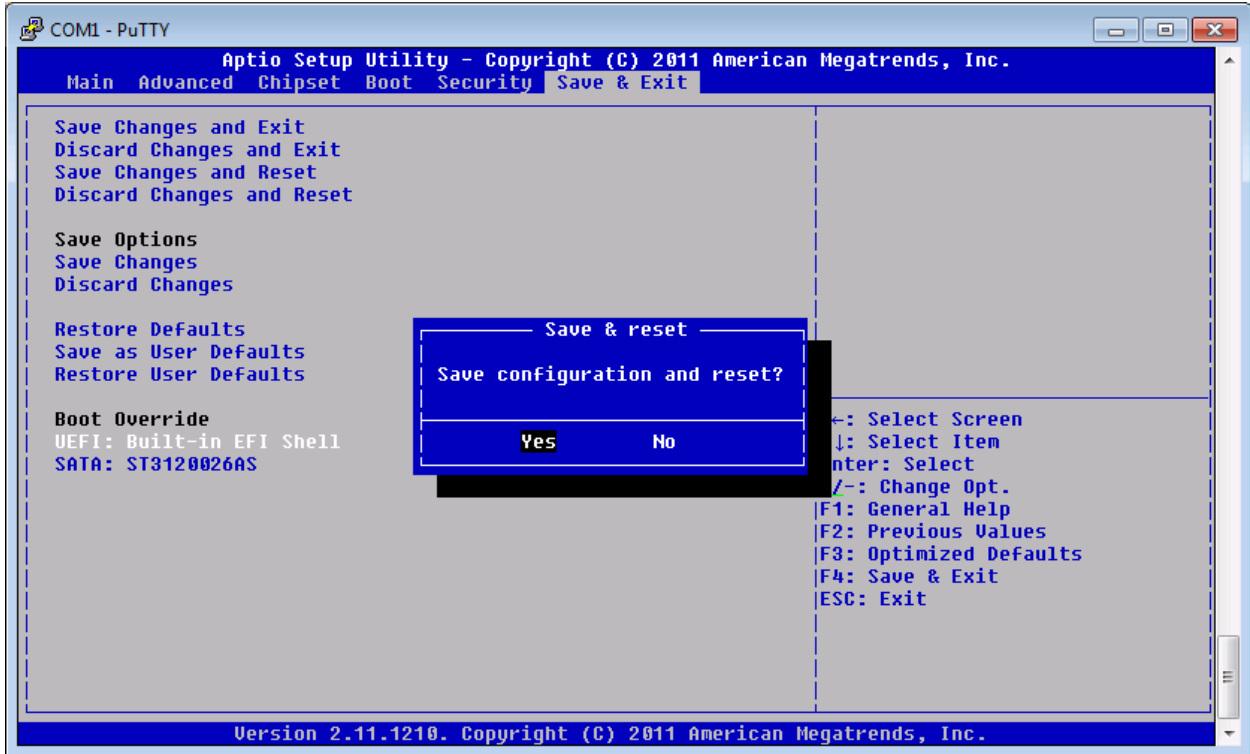

9 Appendix B: Architecture Information

The following sources of information can help you better understand PC architecture.

9.1 Buses

9.1.1 ISA, Standard PS/2 - Connectors

- » AT Bus Design: Eight and Sixteen-Bit ISA, E-ISA and EISA Design, Edward Solari, Annabooks, 1990, ISBN 0-929392-08-6
- » AT IBM Technical Reference Vol. 1 and 2, 1985
- » ISA and EISA Theory and Operation, Edward Solari, Annabooks, 1992, ISBN 0929392159
- » ISA Bus Specifications and Application Notes, Jan. 30, 1990, Intel
- » ISA System Architecture, Third Edition, Tom Shanley and Don Anderson, Addison-Wesley Publishing Company, 1995, ISBN 0-201-40996-8
- » Personal Computer Bus Standard P996, Draft D2.00, Jan. 18, 1990, IEEE Inc
- » Technical Reference Guide, Extended Industry Standard Architecture Expansion Bus, Compaq 1989

9.1.2 PCI/104

- » Embedded PC 104 Consortium
The consortium provides information about PC/104 and PC/104-Plus technology. You can search for information about the consortium on the Web.
- » PCI SIG
The PCI-SIG provides a forum for its ~900 member companies, who develop PCI products based on the specifications that are created by the PCI-SIG. You can search for information about the SIG on the Web.
- » PCI and PCI-X Hardware and Software Architecture and Design, Fifth Edition, Edward Solari and George Willse, Annabooks, 2001, ISBN 0-929392-63-9.
- » PCI System Architecture, Tom Shanley and Don Anderson, Addison-Wesley, 2000, ISBN 0-201-30974-2.

9.2 General PC Architecture

- » Embedded PCs, MarktandTechnik GmbH, ISBN 3-8272-5314-4 (German)
- » Hardware Bible, Winn L. Rosch, SAMS, 1997, 0-672-30954-8
- » Interfacing to the IBM Personal Computer, Second Edition, Lewis C. Eggebrecht, SAMS, 1990, ISBN 0-672-22722-3

- » The Indispensable PC Hardware Book, Hans-Peter Messmer, Addison-Wesley, 1994, ISBN 0-201-62424-9
- » The PC Handbook: For Engineers, Programmers, and Other Serious PC Users, Sixth Edition, John P. Choisser and John O. Foster, Annabooks, 1997, ISBN 0-929392-36-1

9.3 Ports

9.3.1 RS-232 Serial

- » EIA-232-E standard
The EIA-232-E standard specifies the interface between (for example) a modem and a computer so that they can exchange data. The computer can then send data to the modem, which then sends the data over a telephone line. The data that the modem receives from the telephone line can then be sent to the computer. You can search for information about the standard on the Web.
- » RS-232 Made Easy: Connecting Computers, Printers, Terminals, and Modems, Martin D. Seyer, Prentice Hall, 1991, ISBN 0-13-749854-3
- » National Semiconductor: The Interface Data Book includes application notes. Type "232" as search criteria to obtain a list of application notes. You can search for information about the data book on National Semiconductor's Web site.

9.3.2 Serial ATA

- » Serial AT Attachment (ATA) Working Group
This X3T10 standard defines an integrated bus interface between disk drives and host processors. It provides a common point of attachment for systems manufacturers and the system. You can search for information about the working group on the Web. We recommend you also search the Web for information on 4.2 I/O cable, if you use hard disks in a DMA3 or PIO4 mode.

9.3.3 USB

- » USB Specification
USB Implementers Forum, Inc. is a non-profit corporation founded by the group of companies that developed the Universal Serial Bus specification. The USB-IF was formed to provide a support organization and forum for the advancement and adoption of Universal Serial Bus technology. You can search for information about the standard on the Web.

9.4 Programming

- » C Programmer's Guide to Serial Communications, Second Edition, Joe Campbell, SAMS, 1987, ISBN 0-672-22584-0

- » Programmer's Guide to the EGA, VGA, and Super VGA Cards, Third Edition, Richard Ferraro, Addison-Wesley, 1990, ISBN 0-201-57025-4
- » The Programmer's PC Sourcebook, Second Edition, Thom Hogan, Microsoft Press, 1991, ISBN 1-55615-321-X
- » Undocumented PC, A Programmer's Guide to I/O, CPUs, and Fixed Memory Areas, Frank van Gilluwe, Second Edition, Addison-Wesley, 1997, ISBN 0-201-47950-8

Preliminary Draft

10 Appendix C: Document Revision History

Revision	Date	Changes
0.5	07-04-11	Initial review draft
0.65		First published draft (preliminary)
0.85		Second review draft
0.90	12-07-11	Third review draft (preliminary)
0.95	12-13-11	Second published draft (preliminary)
0.96	27-Feb-12	Updated naming to COMe-cOH# throughout plus corrected CPU information in section 3.1

Corporate Offices

Europe, Middle East and Africa	North America	Asia Pacific
Oskar-von-Miller-Str. 1 85386 Eching/Munich Germany Tel.: +49 (0)8165/ 77 777 Fax: +49 (0)8165/ 77 219 info@kontron.com	14118 Stowe Drive Poway, CA 92064- 7147 USA Tel.: +1 888 294 4558 Fax: +1 858 677 0898 info@us.kontron.com	17 Building, Block #1, ABP. 188 Southern West 4th Ring Beijing 100070, P.R.China Tel.: + 86 10 63751188 Fax: + 86 10 83682438 info@kontron.cn

Preliminary Draft