

# » User's Guide «



## **KBox B-101**

**User's Guide** (Version 1.00)  
1056-8384

This page is intentionally left blank.

# 1. Table of Contents

<b>1. Table of Contents</b> .....	<b>1</b>
1.1. Table of Figures.....	2
<b>2. Introduction</b> .....	<b>4</b>
2.1. Symbols used in this Manual.....	5
<b>3. Important Instructions</b> .....	<b>6</b>
3.1. Warranty Note .....	6
3.2. Exclusion of Accident Liability Obligation.....	6
3.3. Liability Limitation / Exemption from the Warranty Obligation .....	6
<b>4. General Safety Instructions for IT Equipment</b> .....	<b>7</b>
4.1. Electrostatic Discharge (ESD) .....	8
4.1.1. Grounding Methods.....	8
4.2. Instructions for the Lithium Battery.....	9
<b>5. Electromagnetic Compatibility (Class A Device)</b> .....	<b>10</b>
5.1. Electromagnetic Compatibility (EU) .....	10
5.2. FCC Statement (USA).....	10
5.3. EMC Compliance (Canada) .....	10
<b>6. Scope of Delivery</b> .....	<b>11</b>
6.1. Type Label and Product Identification .....	11
<b>7. Product Description</b> .....	<b>12</b>
7.1. Front Side.....	13
7.1.1. Power Supply Unit (AC) .....	13
7.1.2. Controls and Indicators.....	13
7.1.3. Interfaces on the Front Side.....	15
7.2. Rear Side .....	17
7.3. Right/Left and Top Side.....	18
7.4. Bottom side .....	19
<b>8. Handling internal Components</b> .....	<b>20</b>
8.1.1. Opening and Closing the KBox B-101.....	20
8.1.2. Installing/Removing Expansion Cards.....	21
8.1.3. Replacing the Lithium Battery.....	22
<b>9. Setting up the KBox B-101</b> .....	<b>23</b>
9.1. KBox B-101 – Desktop Version .....	24
9.2. Wall/Table Mounting using the Brackets .....	25
9.2.1. Brackets for Wall Mounting .....	25
9.2.2. Brackets for Table Mounting .....	26
<b>10. Starting Up</b> .....	<b>27</b>
10.1. AC Power Connection.....	27
10.2. Operating System and Hardware Component Drivers.....	28
<b>11. Maintenance and Prevention</b> .....	<b>29</b>
<b>12. Technical Data</b> .....	<b>30</b>
12.1. Electrical Specifications .....	31

12.2. Mechanical Specifications .....	31
12.2.1. KBox B-101 Desktop Dimensions .....	31
12.2.2. Dimensions for Wall Mounting.....	32
12.2.3. Dimensions for Table Mounting .....	33
12.3. Environmental Specifications .....	34
12.4. CE Directives and Standards .....	35
<b>13. Standard Interfaces – Pin Assignments .....</b>	<b>36</b>
13.1.1. Serial Interfaces COM 1 and COM 2 (RS232).....	36
13.1.2. DP Connector (DisplayPort) .....	36
13.1.3. USB 2.0 Port.....	37
13.1.4. USB3.0 Port.....	37
<b>14. Technical Support .....</b>	<b>38</b>
14.1. Returning Defective Merchandise .....	38

## 1.1. Table of Figures

Fig. 1: Front view .....	11
Fig. 2: Rear view .....	11
Fig. 3: Bottom view .....	12
Fig. 4: Right side view .....	12
Fig. 5: Front view .....	12
Fig. 6: Left side view .....	12
Fig. 7: Top view.....	12
Fig. 8: Rear view .....	12
Fig. 9: KBox B-101 – front view.....	13
Fig. 10: KBox B-101 – Controls and Indicators .....	13
Fig. 11: External interfaces of the integrated motherboard .....	15
Fig. 12: Rear side of the KBox B-101 .....	17
Fig. 13: Right side of the chassis .....	18
Fig. 14: Top side of the chassis .....	18
Fig. 15: Left side of the chassis .....	18
Fig. 16: Bottom side (shown as desktop version).....	19
Fig. 17: Expansion Slots of the KBox B-101 .....	21
Fig. 18: Lithium battery.....	22
Fig. 19: Desktop version of the KBox B-101, with rubber feet attached .....	24
Fig. 20: KBox B-101 with brackets for wall mounting installed .....	25
Fig. 21: KBox B-101 with brackets for table mounting installed .....	26
Fig. 22: AC input connector on the front side of the chassis.....	27
Fig. 23: Dimensions in the front view (desktop version).....	31

Fig. 24: Dimensions in the side view and top view (desktop version) ..... 31

Fig. 25: Dimensions in the front view (wall mounting) ..... 32

Fig. 26: Dimensions in the side view (wall mounting) ..... 32

Fig. 27: Dimensions in the front view (table mounting)..... 33

Fig. 28: Dimensions in the side view (table mounting) ..... 33





## 2. Introduction

Kontron would like to point out that the information contained in this manual may be subject to technical alteration, particularly as a result of the constant upgrading of Kontron products. The attached documentation does not entail any guarantee on the part of Kontron with respect to technical processes described in the manual or any product characteristics set out in the manual. Kontron does not accept any liability for any printing errors or other inaccuracies in the manual unless it can be proven that Kontron is aware of such errors or inaccuracies or that Kontron is unaware of these as a result of gross negligence and Kontron has failed to eliminate these errors or inaccuracies for this reason. Kontron expressly informs the user that this manual only contains a general description of technical processes and instructions which may not be applicable in every individual case. In cases of doubt, please contact Kontron.

This manual is protected by copyright. All rights are reserved by Kontron. Copies of all or part of this manual or translations into a different language may only be made with the prior written consent of Kontron. Kontron points out that the information contained in this manual is constantly being updated in line with the technical alterations and improvements made by Kontron to the products and thus this manual only reflects the technical status of the products by Kontron at the time of printing.

© 2014 by Kontron Europe GmbH  
Lise-Meitner-Str. 3-5  
86156 Augsburg  
Germany

## 2.1. Symbols used in this Manual

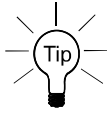
Symbol	Meaning
	This symbol indicates the danger of injury to the user or the risk of damage to the product if the corresponding warning notices are not observed.
	This symbol indicates that the product or parts thereof may be damaged if the corresponding warning notices are not observed.
	This symbol indicates general information about the product and the user manual.
	This symbol indicates detail information about the specific product configuration.
	This symbol precedes helpful hints and tips for daily use.

## 3. Important Instructions

This manual provides important information required for the proper operation of the KBox B-101!

This chapter contains instructions which must be observed when working with the KBox B-101.

### 3.1. Warranty Note

Due to their limited service life, parts which by their nature are subject to a particularly high degree of wear (wearing parts) are excluded from the warranty beyond that provided by law. This applies to the CF card, for example.

### 3.2. Exclusion of Accident Liability Obligation

Kontron shall be exempted from the statutory accident liability obligation if the user fails to observe the included document: "General Safety Instructions for IT Equipment" the hints in this manual or eventually the warning signs label on the device.

### 3.3. Liability Limitation / Exemption from the Warranty Obligation

In the event of damage to the device caused by failure to observe the included document "General Safety Instructions for IT Equipment", the hints in this manual or eventually the warning signs label on the device, Kontron shall not be required to honor the warranty even during the warranty period and shall be exempted from the statutory accident liability obligation..



## 4. General Safety Instructions for IT Equipment



Please read this chapter carefully and take careful note of the instructions, which have been compiled for your safety and to ensure to apply in accordance with intended regulations. If the following general safety instructions are not observed, it could lead to injuries to the operator and/or damage of the product; in cases of nonobservance of the instructions Kontron is exempt from accident liability, this also applies during the warranty period.

The product has been built and tested according to the basic safety requirements for low voltage (LVD) applications and has left the manufacturer in safety-related, flawless condition. To maintain this condition and to also ensure safe operation, the operator must not only observe the correct operating conditions for the product but also the following general safety instructions:

- The product must be used as specified in the product documentation, in which the instructions for safety for the product and for the operator are described. These contain guidelines for setting up, installation and assembly, maintenance, transport or storage.
- The on-site electrical installation must meet the requirements of the country's specific local regulations.
- If a power cable comes with the product, only this cable should be used. Do not use an extension cable to connect the product.
- To guarantee that sufficient air circulation is available to cool the product, please ensure that the ventilation openings are not covered or blocked. If a filter mat is provided, this should be cleaned regularly. Do not place the system close to heat sources or damp places. Make sure the system is well ventilated.
- Only devices or parts which fulfill the requirements of SELV circuits (Safety Extra Low Voltage) as stipulated by IEC 60950-1 may be connected to the available interfaces.
- Before opening the device, make sure that the device is disconnected from the mains.
- Switching off the device by its power button does not disconnect it from the mains. Complete disconnection is only possible if the power cable is removed from the wall plug or from the device. Ensure that there is free and easy access to enable disconnection.
- The device may only be opened for the insertion or removal of add-on cards (depending on the configuration of the system). This may only be carried out by qualified operators.
- If extensions are being carried out, the following must be observed:
  - all effective legal regulations and all technical data are adhered to
  - the power consumption of any add-on card does not exceed the specified limitations
  - the current consumption of the system does not exceed the value stated on the product label.
- Only original accessories that have been approved by Kontron can be used.
- Please note: safe operation is no longer possible when any of the following applies:
  - the device has visible damages or
  - the device is no longer functioning

In this case the device must be switched off and it must be ensured that the device can no longer be operated.

### Additional safety instructions for DC power supply circuits

- ❑ To guarantee safe operation of devices with DC power supply voltages larger than 60 volts DC or a power consumption larger than 240 VA, please observe that:
  - the device is set up, installed and operated in a room or enclosure marked with "RESTRICTED ACCESS", if there are no safety messages on product as safety signs and labels on the device itself.
  - no cables or parts without insulation in electrical circuits with dangerous voltage or power should be touched directly or indirectly
  - a reliable protective earthing connection is provided
  - a suitable, easily accessible disconnecting device is used in the application (e.g. overcurrent protective device), if the device itself is not disconnectable
  - a disconnect device, if provided in or as part of the equipment, shall disconnect both poles simultaneously
  - interconnecting power circuits of different devices cause no electrical hazards
- ❑ A sufficient dimensioning of the power cable wires must be selected – according to the maximum electrical specifications on the product label – as stipulated by EN60950-1 or VDE0100 or EN60204 or UL508 regulations.
- ❑ The devices do not generally fulfill the requirements for "centralized DC power systems" (UL 60950-1, Annex NAB; D2) and therefore may not be connected to such devices!



## 4.1. Electrostatic Discharge (ESD)

A sudden discharge of electrostatic electricity can destroy static-sensitive devices or micro-circuitry. Proper packaging and grounding techniques are necessary precautions to prevent damage. Always take the following precautions:

1. Transport boards in static-safe containers such as boxes or bags.
2. Keep electrostatic sensitive parts in their containers until they arrive at the ESD-safe workplace.
3. Always be properly grounded when touching a sensitive board, component, or assembly.
4. Store electrostatic-sensitive boards in protective packaging or on antistatic mats.

### 4.1.1. Grounding Methods

The following measures help to avoid electrostatic damages to the device:

1. Cover workstations with approved antistatic material. Always wear a wrist strap connected to workplace as well as properly grounded tools and equipment.
2. Use anti-static mats, heel straps, or air ionizers to give added protection.
3. Always handle electrostatic sensitive components by their edge or by their casing.
4. Avoid contact with pins, leads, or circuitry.
5. Turn off power and input signals before inserting and removing connectors or connecting test equipment.
6. Keep work area free of non-conductive materials such as ordinary plastic assembly aids and styrofoam.
7. Use field service tools such as cutters, screwdrivers, and vacuum cleaners which are conductive.
8. Always place drives and boards PCB-assembly-side down on the foam.

## 4.2. Instructions for the Lithium Battery

The installed motherboard is equipped with a Lithium battery. When replacing the lithium battery, please follow the corresponding instructions in the subsection 8.1.2 "Replacing the Lithium Battery".



### Caution

Danger of explosion when replacing with wrong type of battery. Replace only with the same or equivalent type recommended by the manufacturer. The lithium battery type must be UL recognized.



Do not dispose of lithium batteries in general trash collection. Dispose of the battery according to the local regulations dealing with the disposal of these special materials, (e.g. to the collecting points for dispose of batteries).

## 5. Electromagnetic Compatibility (Class A Device)

### 5.1. Electromagnetic Compatibility (EU)

This product is intended only for use in industrial areas. The most recent version of the EMC guidelines (EMC Directive 2004/108/EC) and/or the German EMC laws apply. If the user modifies and/or adds to the equipment (e.g. installation of add-on cards) the prerequisites for the CE conformity declaration (safety requirements) may no longer apply.

**Warning!**

This is a class A product. In domestic environment this product may cause radio interference in which case the user may be required to take adequate measures.

### 5.2. FCC Statement (USA)

This equipment has been tested and found to comply with the limits for a Class A digital device, pursuant to Part 15 of the FCC Rules. These limits are designed to provide reasonable protection against harmful interference when the equipment is operated in commercial environment. This equipment generates, uses, and can radiate radio frequency energy and, if not installed and used in accordance with the instruction manual, may cause harmful interference to radio communications. Operation of this equipment in residential area is likely to cause harmful interference in which case the user will be required to correct the interference at his own expense.

### 5.3. EMC Compliance (Canada)

The method of compliance is self-declaration to Canadian standard ICES-003:

(English): This Class A digital apparatus complies with the Canadian ICES-003.

(French): Cet appareil numérique de la class A est conforme à la norme NMB-003 du Canada.

## 6. Scope of Delivery

- KBox B-101 (corresponding to the ordered system configuration)
- Rubber feet (self-adhesive)
- AC power cable
- General Safety Instructions for IT Equipment

### Optional Parts

- Brackets for wall mounting
- Brackets for table mounting

## 6.1. Type Label and Product Identification

The type label (product name, serial number) of your KBox B-101 system is located at the left side of the device (refer to Fig. 15).



Fig. 1: Front view



Fig. 2: Rear view

## 7. Product Description

The KBox B-101 expands the Kontron line of computers - KBox series. The system is equipped with a Mini-ITX Motherboard (with support for Intel® Core™ i7/i5/i3, 4. generation and Pentium® processors).

The KBox B-101 is a compact, actively cooled box PC for industrial control and automation applications.

The rated voltage of the mains can be found on the type label. The type label is located at the left side of the device. For the configuration of your KBox B-101 please follow the ordering options specified in "Configuration Guides – KBox Series" on our web site [www.kontron.com](http://www.kontron.com).



Fig. 3: Bottom view



Fig. 4: Right side view



Fig. 5: Front view



Fig. 6: Left side view



Fig. 7: Top view



Fig. 8: Rear view



Outside a fire enclosure, the device may only be operated in horizontal position. A vertical operating position is only allowed if the device is installed inside a fire enclosure (also if wall-mounted). When switching on the KBox B-101, make sure that the air openings on the front side (Fig. 9, pos. 4) and the rear side (Fig. 12, pos. 3) of the chassis are not obstructed (covered) by any objects.

## 7.1. Front Side

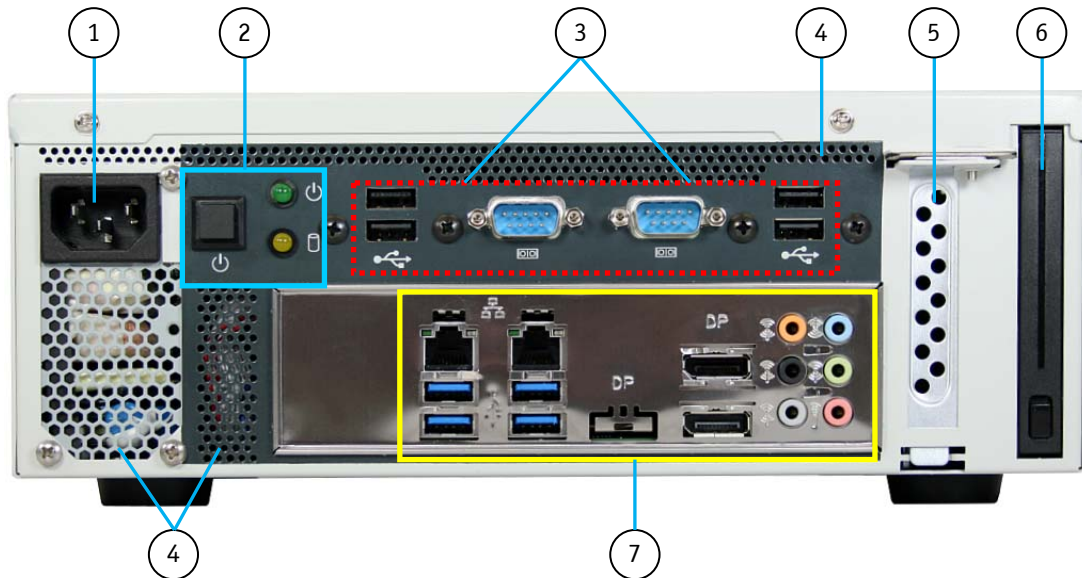

Fig. 9: KBox B-101 – front view

- |  |  |
|--|--|
| 1 AC IN power connector  | 4 Ventilation openings at the front side   |
| 2 Controls and indicators  | 5 PCIe x16 Slot                            |
| 3 Additional interface connectors<br>(routed from the internal onboard interfaces) | 6 Optional drive bay for removable HDD/SSD |
|  | 7 Interfaces of the installed motherboard  |

### 7.1.1. Power Supply Unit (AC)

The 3-pin connector (Fig. 9, pos. 1) provides the power connection to a mains socket via a power cord. Please observe section 10.1 „AC Power Connection“.

### 7.1.2. Controls and Indicators

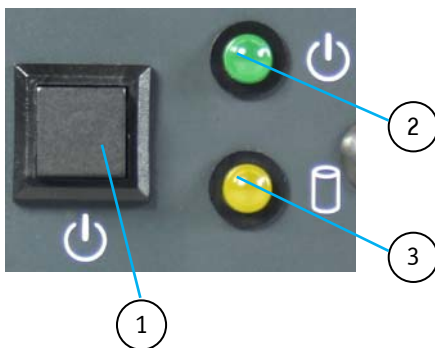

- |                |
|----------------|
| 1 Power button |
| 2 Power LED    |
| 3 HDD LED      |

Fig. 10: KBox B-101 – Controls and Indicators

### 7.1.2.1. Power Button

Press this button (Fig. 10, pos. 1) to turn the system on and off.

**Prerequisite:**

The KBox B-101 must be connected to an appropriate AC mains power source.



**Caution!**

Please observe that turning OFF the system via the power button (see Fig. 10, pos.1) does not disconnect the platform from the AC mains power source.

Even when the system is turned off via the power button (see Fig. 10, pos.1) there is still a standby-voltage of 5 Vsb on the motherboard.

The unit is only completely disconnected from the mains when the power cord is disconnected either from the mains power source or from the unit. Therefore, the power cord and its connectors must always remain easily accessible. The outlet of the AC power source must be located near to the device and be easily accessible.

### 7.1.2.2. Power LED and HDD Activity LED

The power LED (Fig. 10, pos. 2) and the HDD LED (Fig. 10, pos. 3) are located on the front side of the KBox B-101 and indicate the system status.

<p><b>Power LED (green)</b></p>	<p>This LED (Fig. 10, pos. 2) lights up green when the system is turned on by the power button.</p> <p><b>Prerequisite:</b> The system must be connected to the AC power source, using the power cable.</p>
<p><b>HDD-LED (yellow)</b></p>	<p>This LED (Fig. 10, pos. 3) lights up during hard disk activity.</p>
	<p>Do not press the eject button of the (optional) removable HDD/SSD, while the drive LED is lit or is flashing.</p>



## 7.1.3. Interfaces on the Front Side

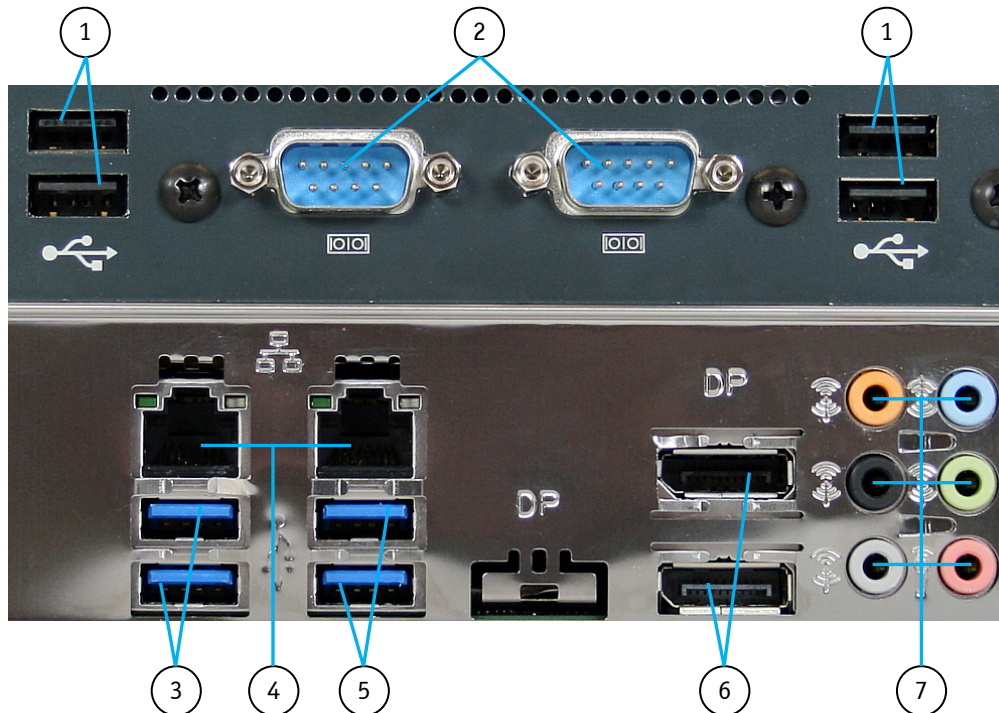

Fig. 11: External interfaces of the integrated motherboard

- |   |                                      |   |                                     |
|---|--------------------------------------|---|-------------------------------------|
| 1 | 4x USB 2.0 port (USB4 - USB7)        | 5 | 2x USB 3.0 port (USB0, USB1)        |
| 2 | 2x serial port (COM1, COM2)          | 6 | 2x DisplayPort Connector (DP0, DP1) |
| 3 | 2x USB 2.0 port (USB2, USB3)         | 7 | Audio connectors                    |
| 4 | 2x LAN port (RJ45) (10/100/1000Mbps) |   |                                     |

## 7.1.3.1. USB Ports

The system is equipped with six USB 2.0 ports and two USB 3.0 ports (Fig. 11, pos. 1, 3 and 5).

## 7.1.3.2. Serial Ports (COM1, COM2)

The serial ports COM1 and COM2 (Fig. 11, pos. 2) consist of a 9-pin, RS232-configured D-SUB connectors that allow the connection of serial peripherals.

## 7.1.3.3. LAN Ports (ETH1, ETH2)

These ports (Fig. 11, pos. 4) consist of RJ45 connectors with integrated LEDs and support a transfer rate of 10/100/1000Mbps.

Left LED Color	Link Status
Off	No Link
Green blinking	Link is established

Right LED Color	Link Speed
Off	10 Base-T/100 Base-T
Yellow	1000 Base-T

#### 7.1.3.4. Display Port Connector

Two external (digital) displays can be connected to the DisplayPort connectors (DP0, DP1) (Fig. 11, pos. 6).



Appropriate Monitors can be connected directly to the DisplayPort connectors using DisplayPort cables. To avoid disturbances, it is recommended not to use any adapters (e.g. DisplayPort/DVI or DisplayPort/HDMI adapter) at the DisplayPort connectors.

#### 7.1.3.5. Audio Connectors

Depending on the operating system and the audio software, the six audio connectors (Fig. 11, pos. 7) can be operated as audio input or output jacks (e.g. Line-In, Line-Out, Mic-In, 5.1 surround etc.).

## 7.2. Rear Side

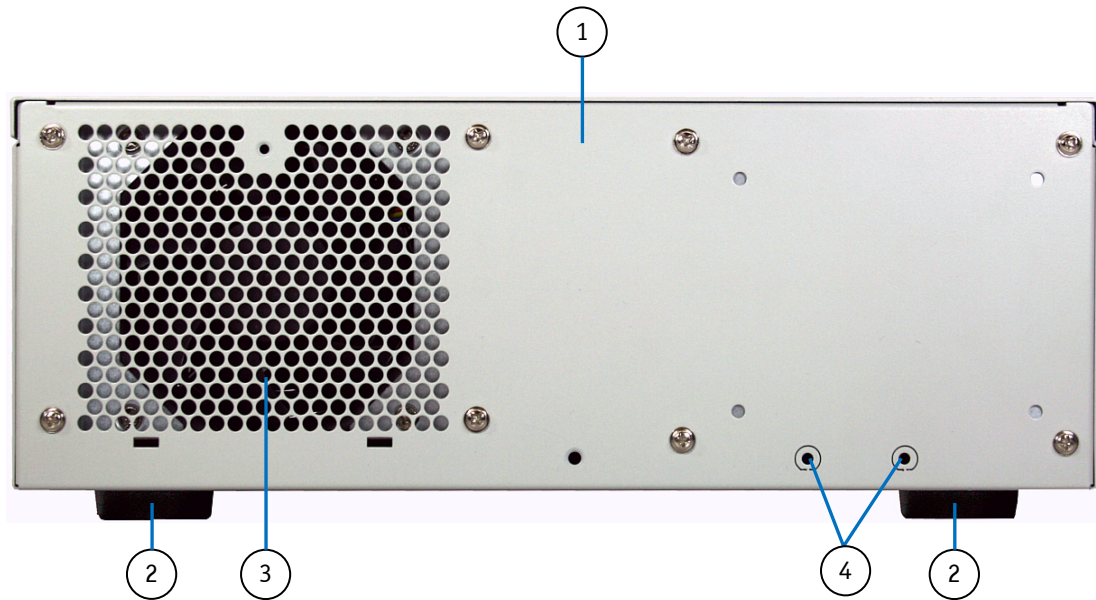

Fig. 12: Rear side of the KBox B-101

- 1 Rear side of the KBox B-101
- 2 Rubber feet (desktop version)
- 3 Air exhaust openings of the internal fan
- 4 Cuttings for the optional installation of two Reverse (RP) SMA connectors by the customer (for mounting optional WLAN/WiFi antennas)

### 7.3. Right/Left and Top Side

At the right and left side of the chassis, the threaded holes for attaching the optional mounting brackets are located. In addition, the type label is attached to the left side of the chassis.

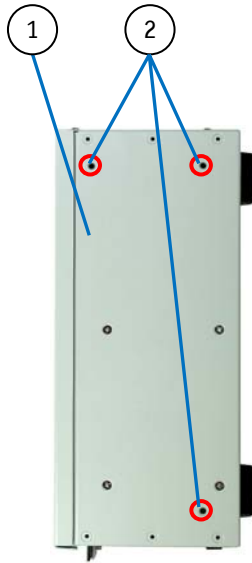

Fig. 13: Right side of the chassis

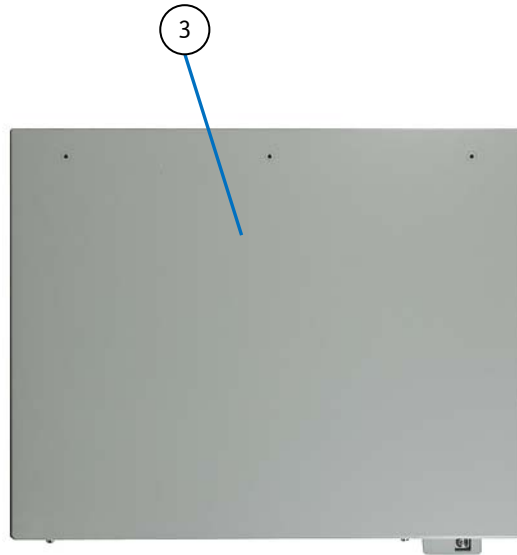

Fig. 14: Top side of the chassis

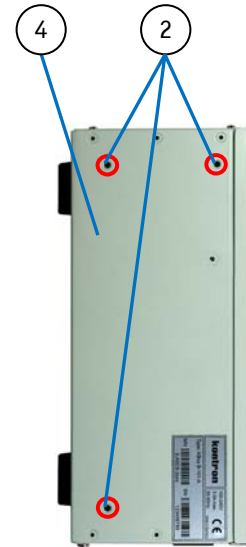

Fig. 15: Left side of the chassis

- |   |  |   |  |
|---|--|---|--|
| 1 | Right side of the chassis                          | 3 | Top side of the chassis (cover)            |
| 2 | Threaded holes for attaching the mounting brackets | 4 | Left side of the chassis (with type label) |

## 7.4. Bottom Side

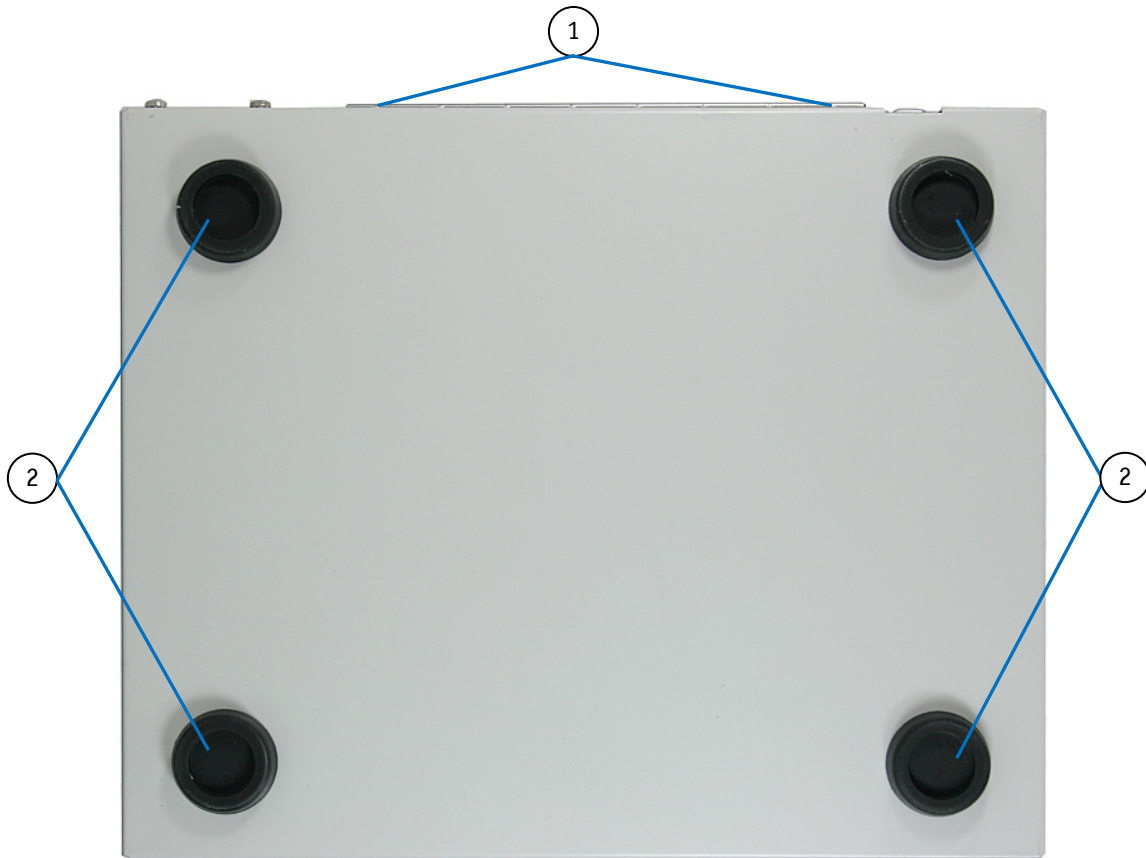

Fig. 16: Bottom side (shown as desktop version)

1 Front side with external interfaces of the installed motherboard

2 Rubber feet (desktop version)



If you intend to convert your device from the desktop version to a wall/table mount version, see also chapter 9 "Setting up the KBox B-101".

## 8. Handling internal Components

This chapter contains important information that you must read before accessing internal components. You must follow these procedures properly when handling any board components of the KBox B-101.

**Before installing/removing an add-on card, please pay attention to the following information:**



Please observe the "General Safety Instructions for IT-Equipment" provided with the system and the installation instructions in this manual (see also chapter 4 and 9).

The installation/removal of add-on cards may only be performed by a qualified person, according to the description in this manual.

Before removing the cover of the device, make sure that the device is switched off and disconnected from the power supply.

Before you upgrade the KBox B-101 with add-on cards, pay attention to the power specifications in chapter 12 "Technical Data" and make sure that the power consumption of the add-on cards does not exceed 5 W.



Please follow the safety instructions for components that are sensitive to electrostatic discharge (ESD). Failure to observe this warning notice may result in damage to the device or the latter's components.



Please pay attention to the manufacturer's instructions before installing/removing an add-on card.

### 8.1.1. Opening and Closing the KBox B-101

In order to install or to remove optional hardware or to change the DIP switch settings, the KBox B-101 needs to be opened. For opening and closing the KBox B-101, please perform the following steps:



Before opening the KBox B-101, the system must be switched off and disconnected from the main power supply. Also disconnect peripheral devices from the KBox B-101. Before you begin, ensure that you have a clean, flat and ESD-safe surface to work on.

1. Close all applications. Shut down the system properly and disconnect the power cord from the power source. Disconnect all peripherals.
2. Place the KBox B-101 on a flat, clean surface.
3. Remove the two screws at the front edge of the cover.
4. Pull/slide the cover to the front a few centimeters (towards the screws removed in step 3) and lift off the cover. Now all internal components inside the chassis can be accessed.
5. For closing the KBox B-101, proceed in reverse order: Place the cover on the chassis and push/slide it backwards (towards the rear side of the chassis) as far as it will go. Secure the cover with the two screws removed in step 3.



## 8.1.2. Installing/Removing Expansion Cards



Before installing an expansion card, please note the information provided by the manufacturer.

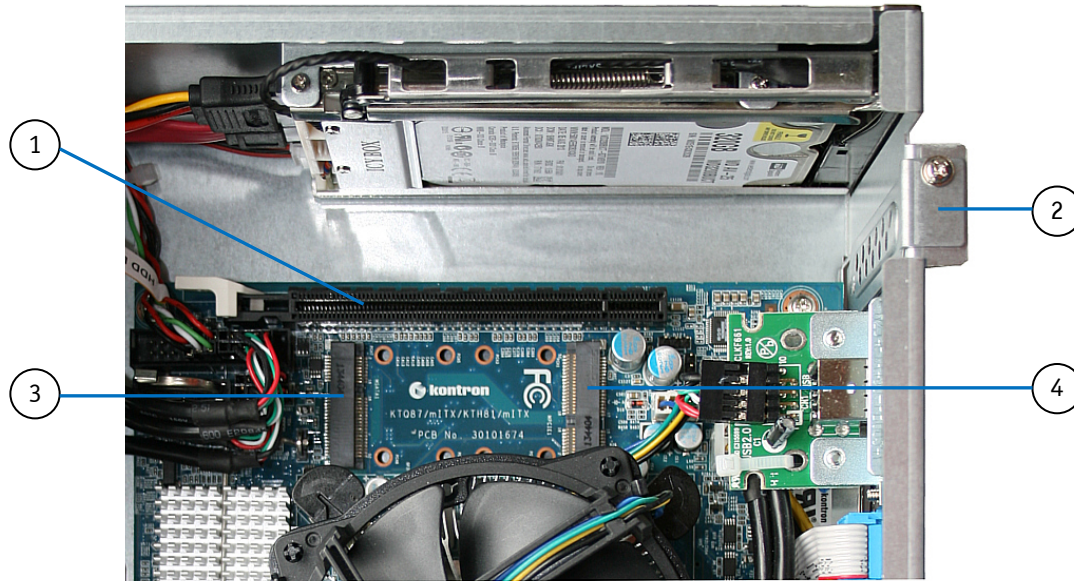

Fig. 17: Expansion Slots of the KBox B-101

- |   |                            |   |                |
|---|----------------------------|---|----------------|
| 1 | PCIe slot                  | 3 | mSATA slot     |
| 2 | Slot bracket for PCIe slot | 4 | Mini-PCIe slot |

In order to install/remove an expansion card, perform the following steps:

1. Open the KBox B-101, as described in subsection 8.1.1 "Opening and Closing the KBox B-101" (steps 1 to 4).
2. After removing the cover, the PCIe slot, the Mini PCI Express slot and the mSATA slot are easily accessible (see Fig. 17). Now, appropriate expansion cards can be installed.



Please note that either only a **full-size Mini PCIe module** or a **full-size mSATA module** or both, a **half-size Mini PCIe module** and a **half-size mSATA module** can be installed at a time, since both slots share the same installation space (1x full-size/2x half-size) on the motherboard!

3. Close the KBox B-101 as described in subsection 8.1.1 "Opening and Closing the KBox B-101" (step 5).

### 8.1.3. Replacing the Lithium Battery

The integrated motherboard of your system is equipped with a lithium battery. To replace the battery, please proceed as follows:

1. Open the unit as described in subsection 8.1.1 "Opening and Closing the KBox B-101" (step 1-4).
2. Remove the lithium battery from the holder by pulling the ejector spring outwards.
3. Place a new lithium battery into the battery holder.
4. Pay attention to the polarity of the battery.
5. The lithium battery must be replaced with an identical battery or a battery type recommended by Kontron (Lithium battery 3.0 V for RTC, type: CR2032).
6. Close the device, as described in the subsection 8.1.1 "Opening and Closing the KBox B-101" (step 5).

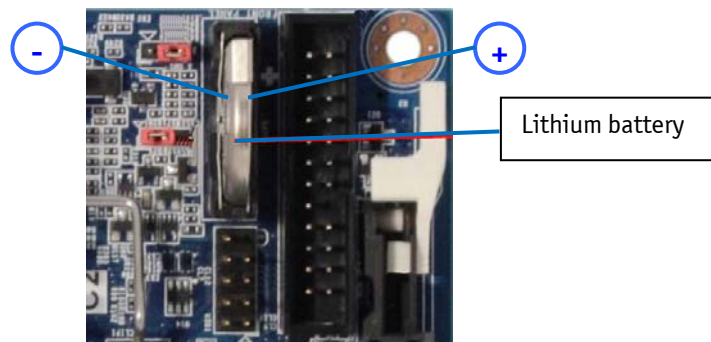

Fig. 18: Lithium battery



#### Caution

Danger of explosion when replacing with wrong type of battery. Replace only with the same or equivalent type recommended by the manufacturer. The Lithium battery type must be UL recognized.



Do not dispose of lithium batteries in general trash collection. Dispose of the battery according to the local regulations dealing with the disposal of these special materials, (e.g. to the collecting points for disposal of batteries).



## 9. Setting up the KBox B-101



### Important Instructions!

In order to setting-up, installing/removing the KBox B-101 platform, please observe the instructions described in this manual.

The device may only be set up and installed by maintenance personnel responsible for this area (and aware of the dangers involved).

Outside a fire enclosure, the device may only be operated in horizontal position.

**A vertical operating position is only allowed if the device is installed inside a fire enclosure.**

Please observe all specified dimensions required for mounting included in the drawing with outline dimensions for the KBox B-101 platform. The corresponding drawing can be downloaded from our web site [www.kontron.com](http://www.kontron.com) by selecting the product name.

Leave at least 100 mm (approximately 3.937") free space to the front and rear of the unit in order to have access to the interfaces to connect the peripherals and to operate the power button.

When mounted into a cabinet: the cabinet must have adequate space for the KBox B-101 platform, and corresponding spaces for air circulation and cable connections (see also section 12.2 "Mechanical Specifications"). Furthermore, the cabinet must have a sufficient, optionally active ventilation to prevent overheating.

Make sure that the ventilation openings of the chassis are not obstructed (covered) by any objects.

For mounting to a table or to a wall: Use only the optional brackets (not included) and the countersunk M4x6 screws described in the following section. Longer screws can damage the device!

The platform must be firmly attached to a clean flat and solid mounting surface. Use proper fastening materials suitable for the mounting surface. Ensure that the mounting surface type and the used mounting solution safely support the load of the KBox B-101 platform and the attached components. It is recommended to use screws with a diameter of 5 mm (0.197"). The screw type and length as well as accessories like anchors depend on the type and the consistence of the mounting surface (table, wall, cabinet etc.).

Please follow the local/national regulations for grounding.

The voltage feeds must not be overloaded.

Adjust the cabling and the external overcharge protection to correspond with the electrical data indicated on the type label.

The type label is located on the left side of the unit (refer to Fig. 15).

## 9.1. KBox B-101 – Desktop Version

For the desktop version, the self-adhesive rubber feet (included) have to be attached to the bottom side of the device. When setting up the device, make sure that the ventilation openings on the front and rear side of the chassis are not obstructed (covered) by any objects (refer to subsection 12.2.1 "KBox B-101 Desktop Dimensions").



Fig. 19: Desktop version of the KBox B-101, with rubber feet attached

## 9.2. Wall/Table Mounting using the Brackets

In order to mount the KBox B-101 to a wall, on a table or into a cabinet, you may order the corresponding mounting brackets. You can adapt your desktop KBox B-101 to a wall or table mount system by attaching the appropriate mounting brackets to the corresponding sides of the KBox B-101.



Please observe the "General Safety Instructions for IT Equipment" (included) and the installation instructions (refer to the chapters 4 and 0).

Outside a fire enclosure, the device may only be operated in horizontal position. A vertical operating position is only allowed if the device is installed inside a fire enclosure.

### 9.2.1. Brackets for Wall Mounting

These brackets (Fig. 20) are used to mount the KBox B-101 to a wall.



Wall mounting outside a fire enclosure is only allowed in horizontal position (2 operating positions). Inside a fire enclosure, you may choose which side is facing up or down (4 operating positions). The two brackets are symmetrical and can be mounted on either the left or right (see also subsection 12.2.2 "Dimensions for Wall Mounting").

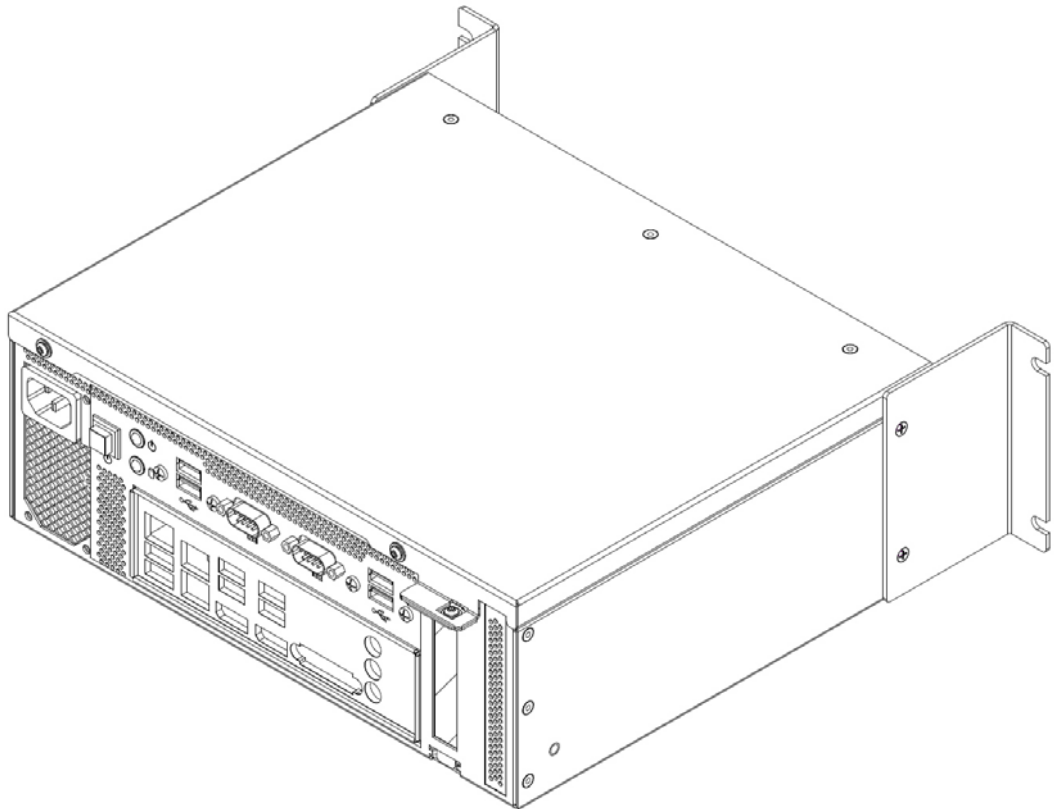

Fig. 20: KBox B-101 with brackets for wall mounting installed

### 9.2.2. Brackets for Table Mounting

These brackets (Fig. 21) are used to mount the KBox B-101 to a table.



Table outside a fire enclosure is only allowed in horizontal position (2 operating positions). Inside a fire enclosure, you may choose which side is facing up or down (4 operating positions). The two brackets are symmetrical and can be mounted on either the left or right (see also subsection 12.2.2 "Dimensions for Wall Mounting").

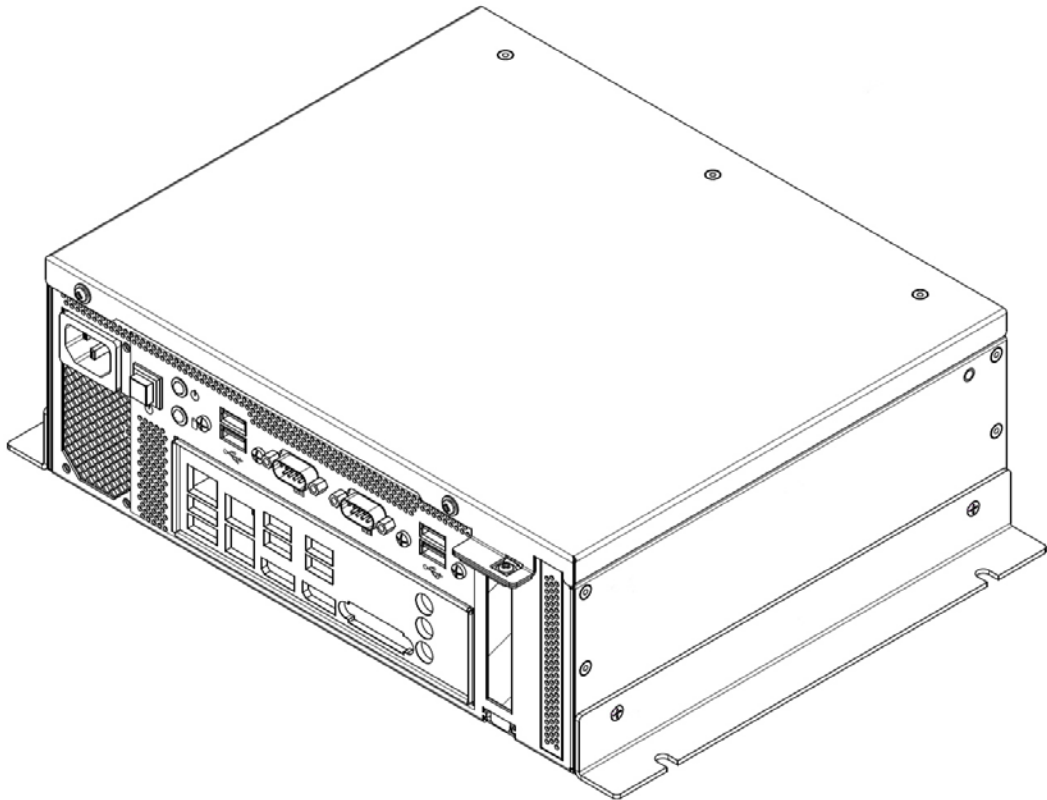

*Fig. 21: KBox B-101 with brackets for table mounting installed*



Table mounting (by using the corresponding brackets) is only possible without the rubber feet attached. Rubber feet that are already attached to the chassis of the KBox B-101 (e.g. when adapting a desktop version) must be removed before table mounting.

## 10. Starting Up



The rated voltage of the power supply must correspond with the voltage value on the type label.

### 10.1. AC Power Connection

The AC input connector (Fig. 9, pos. 1) is located on the front side of the KBox B-101.

	<p>The KBox B-101 can be connected to an AC supply circuit using an AC power cord (see Fig. 22).</p>
	<p>Even when the system is turned off via the power button (Fig. 10, pos. 1) there is still a standby-voltage of 5 Vsb on the SBC.</p> <p>Use a power cord suitable for the mains power supply in your country.</p> <p>Make sure that the mains power supply (power outlet) is properly grounded and that the power cord is in perfect condition without any visible damage. An ungrounded power supply is not permissible.</p>

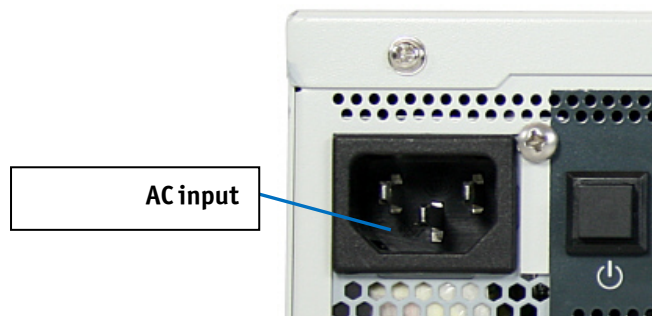

Fig. 22: AC input connector on the front side of the chassis

To connect the KBox B-101 to a corresponding AC main power supply, please perform the following steps:

1. Insert the corresponding connector of the supplied AC power cord into the AC input connector (Fig. 9, pos. 1, Fig. 22). The AC input connector is located on the front side of the KBox B-101.
2. Connect the AC power cord to an appropriate AC mains socket.



The power cord is used as a disconnecting device (the unit is only completely disconnected from the mains, when the power cord is disconnected either from the mains or the unit). Therefore, the outlet of the AC power source must be located near to the device and be easily accessible.

## 10.2. Operating System and Hardware Component Drivers

Your system can be supplied optionally with a pre-installed operating system.

If you have ordered your KBox B-101 with a pre-installed operating system, all drivers are installed in accordance with the system configuration ordered (optional hardware components). Your system is fully operational when you switch it on for the first time. Please pay attention to the following note.



**Important information on the use of the pre-installed “WINDOWS 7 ULTIMATE FOR EMBEDDED SYSTEMS” or “WINDOWS 7 PROFESSIONAL FOR EMBEDDED SYSTEMS” operating systems:**

The terms and conditions for the use of the pre-installed operating systems are specified in the document “MICROSOFT SOFTWARE LICENSE TERMS”.

You can download this document from our web site [www.kontron.com](http://www.kontron.com) by selecting Product/ Downloads tab/Windows.

If you have ordered The KBox B-101 without a pre-installed operating system, you will need to install the operating system and the appropriate drivers for the system configuration you have ordered (optional hardware components) yourself.



You can download the relevant drivers for the installed hardware from our web site at [www.kontron.com](http://www.kontron.com) by selecting the product.

Pay attention to the manufacturer specifications of the operating system and the integrated hardware components.

## 11. Maintenance and Prevention

Equipment from Kontron requires only minimum servicing and maintenance for problem-free operation.

- For light soiling, clean the KBox B-101 with a dry cloth.  
Carefully remove dust from the surface of the cooling fins of the chassis using a clean, soft brush.
- Stubborn dirt should be removed using a mild detergent and a soft cloth.

## 12. Technical Data

<b>KBox B-101</b>	
<b>Motherboard</b>	Kontron KTH81Mini-ITX motherboard
<b>Supported Processors</b>	Intel® 4th Gen. Core™ i7/i5/i3 and Pentium® processors
<b>RAM</b>	max.16 GB (2 x 8 GB) DDR3/DDR3L
<b>Chipset</b>	Intel® PCH H81
<b>Storage Media</b>	1x HDD or SSD
<b>BIOS</b>	AMI
<b>Interfaces</b>	Interfaces at the front side: 2x DisplayPort 2x Serial Interface (RS232) 8x USB: 6x USB 2.0; 2x USB 3.0 2x LAN (10/100/1000Mbps) 6x Audio connectors (3.5mm jack plug)
<b>Internal Onboard Slots</b>	1x full-size Mini PCIe x1, 1x mSATA port , 1x PCIe x16 Low Profile
<b>Controls</b> (at the front side)	Power button
<b>Indicators</b> (at the front side)	Power LED HDD LED
<b>AC IN Connector</b> (at the front side)	3-pin IEC socket (IEC 60320 C14)
<b>Leistungsaufnahme pro Steckplatz (Mini PCIexpress)</b>	Max. 5 W
<b>Weight</b>	Approx. 4 kg
<b>Rated Voltage Range</b>	See type label



The corresponding document "Configuration Guide" and the manual of the installed SBC can be downloaded from our web site: [www.kontron.com](http://www.kontron.com) by selecting the product.



## 12.1. Electrical Specifications

The corresponding electrical specifications for your KBox B-101 can be found on the type label of the system. The type label is located on the left side of the unit (refer to Fig. 15).

## 12.2. Mechanical Specifications

### 12.2.1. KBox B-101 Desktop Dimensions



For sufficient air circulation, make sure that the ventilation openings of the chassis are not obstructed (covered) by any objects.

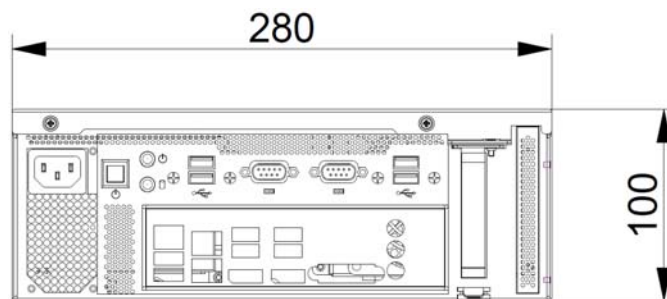

Fig. 23: Dimensions in the front view (desktop version)

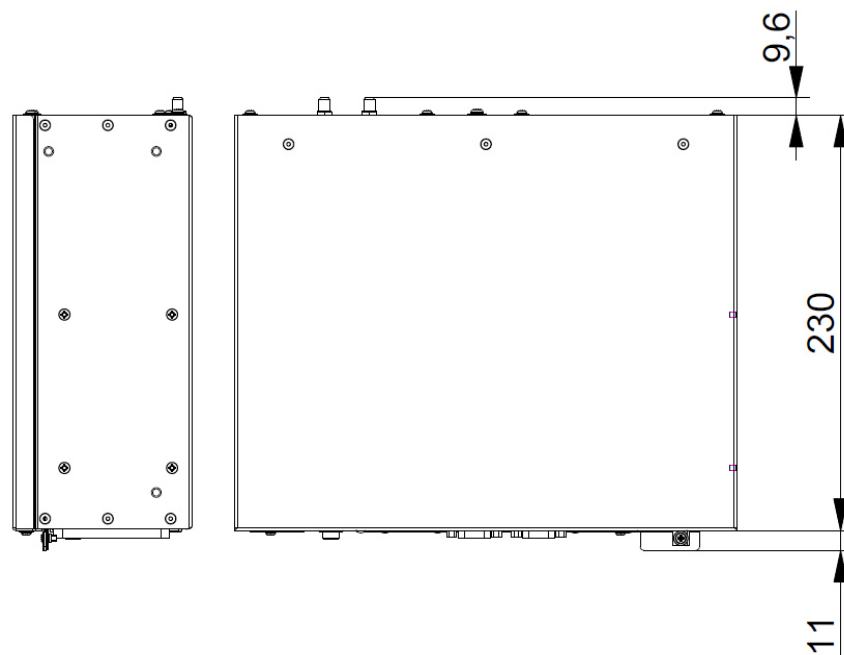

Fig. 24: Dimensions in the side view and top view (desktop version)

12.2.2. Dimensions for Wall Mounting



For sufficient air circulation, make sure that the ventilation openings of the chassis are not obstructed (covered) by any objects. The wall mounting brackets provide enough space between the wall and the chassis (for the fan on the rear side of the chassis) (see Fig. 26).

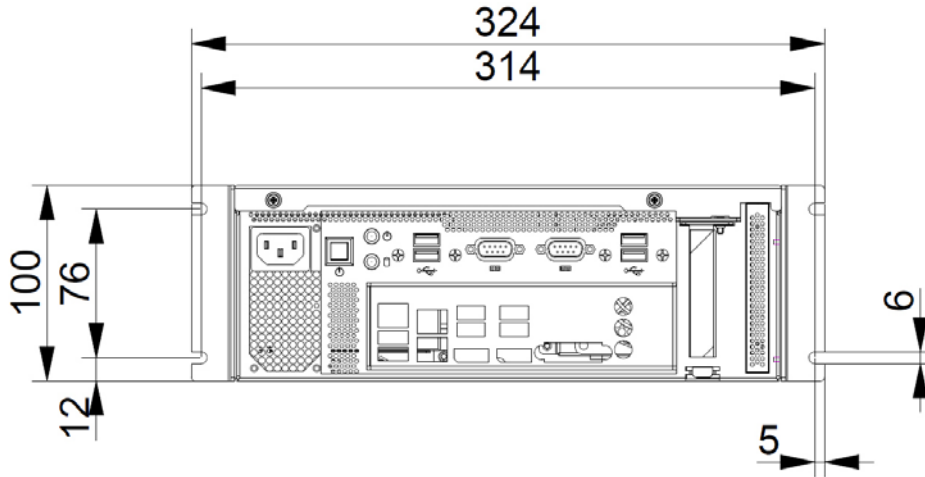

Fig. 25: Dimensions in the front view (wall mounting)

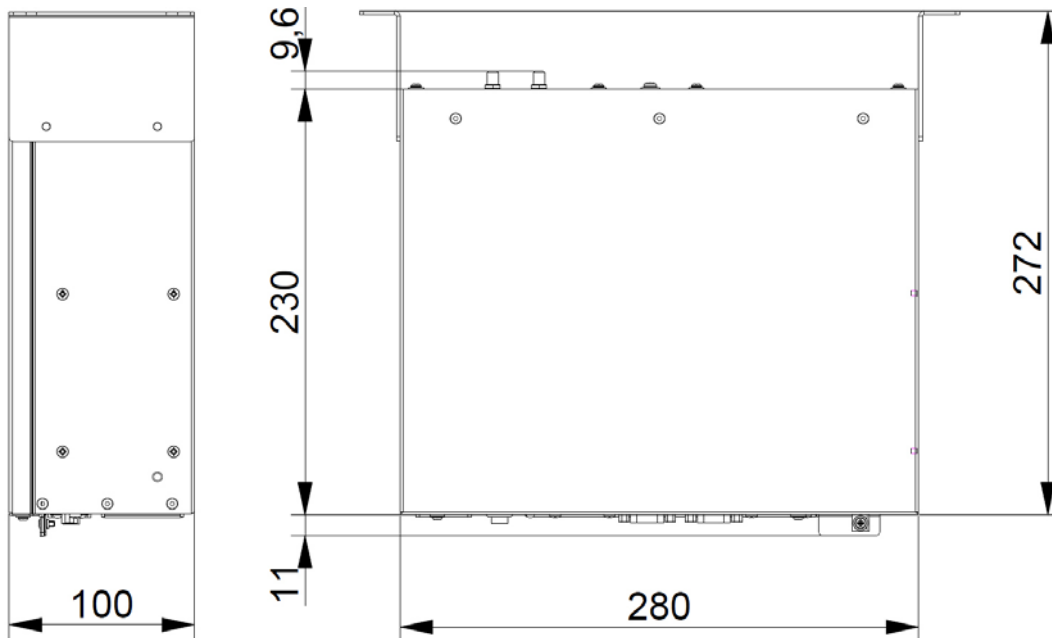

Fig. 26: Dimensions in the side view (wall mounting)

### 12.2.3. Dimensions for Table Mounting



For sufficient air circulation, make sure that the ventilation openings of the chassis are not obstructed (covered) by any objects.

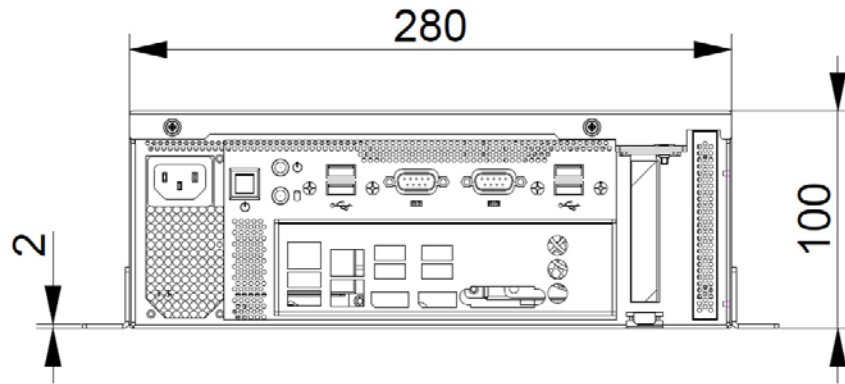

Fig. 27: Dimensions in the front view (table mounting)

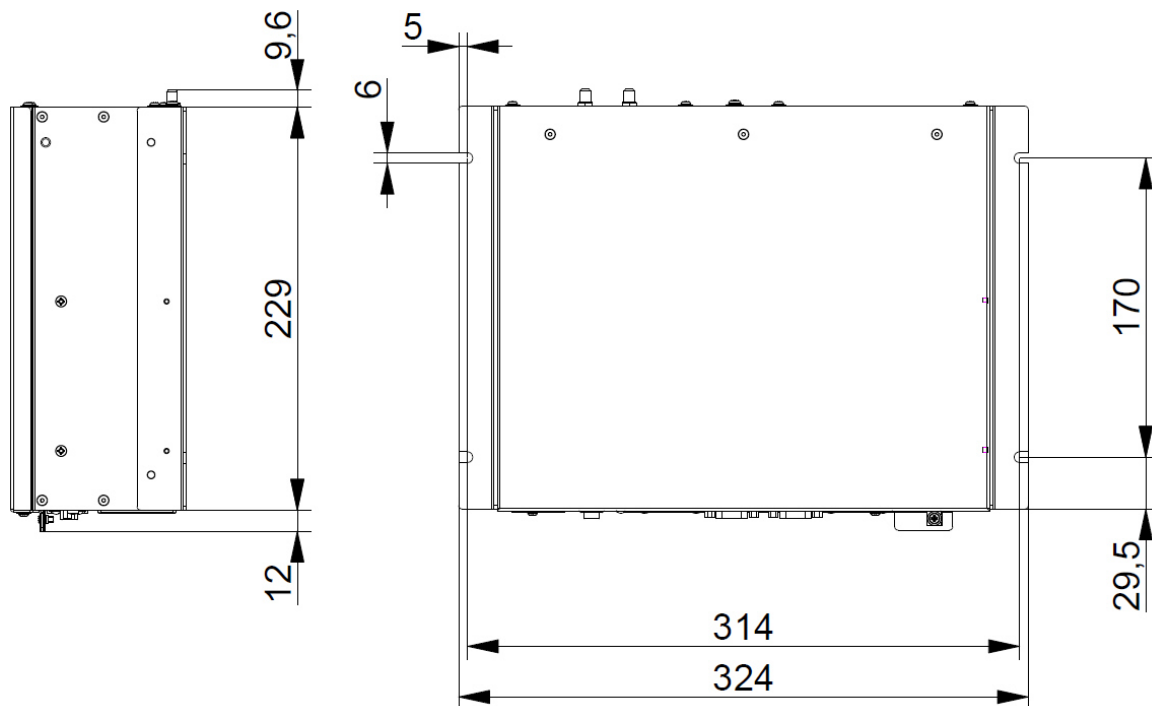

Fig. 28: Dimensions in the side view (table mounting)

### 12.3. Environmental Specifications

<b>Operating Temperature</b>	0 ... +45 °C (32 ... 113 °F)
<b>Storage/Transit Temperature</b>	-25 ... +70 °C (-40 ... +185 °F)
<b>Rel. Humidity (Operating)</b>	95% @ 40 °C (non-condensing)

## 12.4. CE Directives and Standards

CE Directive	
<b>Electrical Safety</b>	General Product Safety Directive (GPSD) 2001/95/EC Low Voltage Directive (LVD) 2006/95/EC
<b>Electromagnetic Compatibility (EMC)</b>	EMC Directive 2004/108/EC
<b>CE Marking</b>	CE Directive 93/68/EEC
<b>RoHS II Directives</b>	2011/65/EU

Electrical Safety	Harmonized Standards
<b>CB Scheme</b>	CB Certification
<b>EUROPE</b>	Information technology equipment - Safety - Part 1: General requirements EN 60950-1+ A11
<b>U.S.A. / CANADA</b>	To meet UL60950-1 / CSA C22.2- No. 60950-1-7

EMC	Harmonized Standards
<b>EU</b>	Generic emission standard for industrial environments (Emission): EN 61000-6-4  Generic standards - Immunity for industrial environments (Immunity): EN 61000-6-2
<b>U.S.A.</b>	FCC 47 CFR Part 15, Class A
<b>CANADA</b>	ICES-003, Class A

## 13. Standard Interfaces – Pin Assignments

Low-active signals are indicated by a minus sign.

### 13.1.1. Serial Interfaces COM 1 and COM 2 (RS232)

Pin	Signal Name	9-pin D-SUB Connector
1	DCD (Data Carrier Detect)	
2	RXD (Receive Data)	
3	TXD (Transmit Data)	
4	DTR (Data Terminal Ready)	
5	GND (Signal Ground)	
6	DSR (Data Set Ready)	
7	RTS (Request to Send)	
8	CTS (Clear to Send)	
9	RI (Ring Indicator)	

### 13.1.2. DP Connector (DisplayPort)

Pin#	Signal Name	DisplayPort	Signal Name	Pin#
1	ML Lane 0 (p)		GND (ML Lane 0)	2
3	ML Lane 0 (n)		Lane 1 (p)	4
5	GND (ML Lane 1)		Lane 1 (n)	6
7	Lane 2 (p)		GND (ML Lane 2)	8
9	Lane 2 (n)		Lane 3 (p)	10
11	GND (ML Lane 3)		Lane 3 (n)	12
13	AUX SEL#		Pull-down to GND	14
15	AUX CH (p)		GND (AUX CH)	16
17	AUX CH (n)		Hot Plug	18
19	GND (GND_DDC)		3.3V (DDC EEPROM power 500 mA fused)	20

13.1.3. USB 2.0 Port

Pin	Signal Name	4-pin USB Connector Typ A Version 2.0
1	VCC	
2	Data-	
3	Data+	
4	GND	

13.1.4. USB3.0 Port

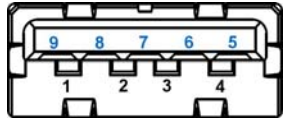
Pin		Signal Name	9-pin USB Connector Type A Version 3.0/2.0
USB 2.0 Contacts	USB 3.0 Contacts		
1	VCC, fused (900 mA max.)	5 StdA_SSRX-	
2	Data-	6 StdA_SSRX+	
3	Data+	7 GND_DRAIN	
4	GND	8 StdA_SSTX-	
		9 StdA_SSTX+	

## 14. Technical Support

For technical support, please contact our Technical Support department:

e-mail: [support@kontron.com](mailto:support@kontron.com)

Web: <http://www.kontron.com/support>

Make sure you have the following information on hand when you call:

- the unit part id number (PN),
- the serial number (SN) of the unit; the serial number can be found on the type label, placed on the right side of the system.

Be ready to explain the nature of your problem to the service technician.

If you have questions about Kontron or our products and services, you can reach us by the above-mentioned telephone number and on e-mail address or at: [www.kontron.com](http://www.kontron.com) .

### 14.1. Returning Defective Merchandise

Please follow these steps before you return any merchandise to Kontron:

1. Download the corresponding form for returning a device with an RMA No. [RMA (Return of Material Authorization)] from our website [www.kontron.com/Support/.RMA Information](http://www.kontron.com/Support/.RMA%20Information); contact our Customer Service department to obtain an RMA No.  
e-mail: [service@kontron.com](mailto:service@kontron.com)
2. Ensure that you have received an RMA number from Kontron Customer Services before returning any device. Write this number clearly on the outside of the package.
3. Describe the fault that has occurred.
4. Please provide the name and telephone number of a person we can contact to obtain more information, where necessary. Where possible, please enclose all the necessary customs documents and invoices.
5. When returning a device:
  - Pack it securely in its original box.
  - Enclose a copy of the RMA form with the consignment.

### Corporate Offices

Europe, Middle East & Africa	North America	Asia Pacific
Lise-Meitner-Str. 3-5 86156 Augsburg Germany Tel.: +49 (0)821/ 0 Fax: +49 (0)821/ 111 <a href="mailto:info@kontron.com">info@kontron.com</a>	14118 Stowe Drive Poway, CA 92064-7147 USA Tel.: +1 888 294 4558 Fax: +1 858 677 0898 <a href="mailto:info@us.kontron.com">info@us.kontron.com</a>	17 Building,Block #1,ABP. 188 Southern West 4th Ring Beijing 100070, P.R.China Tel.: + 86 10 63751188 Fax: + 86 10 83682438 <a href="mailto:info@kontron.cn">info@kontron.cn</a>

