

» User's Guide «



KBox C-101 Family

User's Guide (Version 3.1)
1055-6575

This page has been intentionally left blank.

1. Table of Contents

1. Table of Contents	3
1.1. Table of Figures	5
2. Introduction	9
2.1. Symbols used in this Manual	10
2.2. Information about the System Designation and Description in this Manual.....	10
2.2.1. Product Variants of the KBox C-101 Family.....	10
3. Important Instructions	11
3.1. Obligation of Diligence	11
3.2. Personnel	11
3.3. Appropriate Use, Field of Application	11
3.4. Warranty Note	11
3.5. Exclusion of Accident Liability Obligation	11
3.6. Liability Limitation / Exemption from the Warranty Obligation	11
4. General Safety Instructions for IT Equipment	12
4.1. Electrostatic Discharge (ESD)	13
4.1.1. Grounding Methods	13
4.2. Instructions for the Lithium Battery	14
5. Electromagnetic Compatibility (Class B Device)	15
5.1. Electromagnetic Compatibility (EU)	15
5.2. FCC Statement (USA)	15
5.3. EMC-Compliance (Canada)	15
6. Shipment and Unpacking	16
6.1. Unpacking	16
6.2. Scope of Delivery.....	16
6.2.1. Optional Parts (System Expansion)	16
6.2.2. Optional System Extension.....	16
6.3. Spare Parts	16
6.4. Type Label and Product Identification	17
7. System Overview	18
7.1. RTC (GoldCap).....	20
7.1.1. RTC Buffer Time	20
7.1.2. Setting the RTC.....	20
7.2. Optional RTC Lithium Battery (externally accessible)	21
7.3. System Expansion Capabilities.....	22
7.3.1. Mini PCI Express® Interfaces	22
7.3.2. mSATA (MO-300)	22
7.3.3. Standard PCI Express® Interfaces.....	22
7.3.4. SATA Interfaces	22
7.4. Front Side Configuration and Options - KBox C-101.....	24
7.4.1. X 101 - Power Input Connector	25
7.4.2. X 102/X 103/X 104 - Ethernet Connectors (ETH)	25
7.4.3. X 105/X 106 - USB 3.0.....	25
7.4.4. X 107/X 108 - USB 2.0.....	25
7.4.5. X 109 - DisplayPort.....	25
7.4.6. SDCARD Slot	26

7.4.7. X 110 - RS232 Port	26
7.4.8. POWER Button and PWR LED	27
7.4.9. RESCUE Button and RSQ LED	27
7.4.10. Status and General Purpose LEDs.....	28
7.4.11. X 205 - Optional FIELDBUS Interface	28
7.4.12. PCI/PCIe Expansion Slot 1 and Slot 2.....	29
7.4.13. Internal or Removable 2.5" SATA HDDs/SSDs.....	30
7.5. Left and Right Side View	32
7.6. Top and Bottom Side View	32
7.7. Rear Side View.....	33
7.8. Functional Earth Stud	33
8. System Extensions	34
8.1. (X 204) - Serial Port RS232/RS422	35
8.2. (X 203) - CAN Port	35
8.3. (X 202) - DVI-D Interface Connector or DP 2 DisplayPort	35
8.4. Optional Versions with Fan Tray - KBox C-101-2/-1	36
8.4.1. Fan Tray (only for KBox C-101-1 and KBox C-101-2)	37
9. Accessing Internal Components	38
9.1. Top Cover	39
9.2. Opening and Closing the KBox C-101	40
9.3. Internal View	42
9.3.1. Integrated COMe Module	43
9.3.2. mSATA Socket.....	43
9.3.3. Expansion Socket for PCIe Mini Cards	44
9.3.4. Riser Cards Expansion Sockets for PCI/PCIe Cards	44
9.3.5. Installing/Removing the PCI/PCIe Expansion Cards (for KBox C-101-2/-1 only)	45
9.3.6. Installing/Removing the PCIe Mini Card	46
9.3.7. Installing/Removing an mSATA SSD.....	46
10. Thermal Considerations	47
10.1. Available Processors	47
10.2. Convection Cooling.....	47
10.3. Active Cooling via the optional Fan Tray	47
10.4. Minimum System Clearance	47
10.5. Maximum Temperatures	47
10.6. Third Party Components.....	48
10.7. Processor Thermal Monitoring.....	48
10.8. Processor Thermal Trip Feature.....	48
11. Installation Instructions	49
11.1. Control Cabinet Mounting	50
11.2. DC Power Plug Terminal	53
11.2.1. Cabling.....	53
12. Starting Up.....	54
12.1. Connecting to DC Main Power Supply	54
12.2. Power OFF/ON Procedure	55
12.3. Operating System and Hardware Component Drivers	56
13. Maintenance and Cleaning	57
13.1. Replacing the Lithium Battery.....	57
13.2. Preventive Maintenance for SSD Drives	58

13.3. Replacing the Fan Tray	58
13.4. Cleaning the Air Filter	59
14. KBox C-101-2 Variant	61
15. KBox C-101-1 Variant	63
15.1. KBox C-101-1 - System Expansion Capabilities	65
15.1.1. PCIe Expansion Slot 1	65
15.1.2. Internal or Removable 2.5" SATA HDD/SSD	66
16. KBox C-101-0 Variant	68
16.1. KBox C-101-0 - System Expansion Capabilities	70
16.1.1. Internal 2.5" SATA Drive	70
17. Technical Specifications	71
17.1. Mechanical Specifications of the KBox C-101	72
17.1.1. Mechanical Specifications of the KBox C-101-2	72
17.1.2. Mechanical Specifications of the KBox C-101-2 with Fan Tray Option.....	73
17.1.3. Mechanical Specifications of the KBox C-101-1	75
17.1.4. Mechanical Specifications of the KBox C-101-1 with Fan Tray Option.....	76
17.1.5. Mechanical Specifications of the KBox C-101-0	78
17.2. Environmental Specifications	80
17.3. CE-Directives, Standards and Approvals	81
18. Standard Interfaces – Pin Assignments.....	82
18.1.1. (X 101) Power Input Connector.....	82
18.1.2. (X 110) Serial Interface RS232	82
18.1.3. (X 109) DisplayPort.....	83
18.1.4. (X 107, X 108) USB 2.0 Port	83
18.1.5. (X 105, X 105) USB3.0 Port.....	83
18.1.6. (X 102, X 103, X 104) Ethernet Connectors.....	84
18.2. Optional Interfaces via Adapter Modules	85
18.2.1. (X 202) DVI-D (Single Link)	85
18.2.2. (X 202) DP 2 - DisplayPort	85
18.2.3. (X 204) Serial Port RS232/RS422	86
18.2.4. (X 203) CAN Bus Port.....	87
19. Technical Support	88
19.1. Returning Defective Merchandise	88

1.1. Table of Figures

Fig. 1: Example of KBox C-101 type label	17
Fig. 2: KBox C-101 family	18
Fig. 3: RTC buffer time depending on temperature	20
Fig. 4: Lithium battery location (shown with protective cover)	21
Fig. 5: Lithium battery location (externally accessible battery shown with removed protective cover)	21
Fig. 6: Bottom side view	23
Fig. 7: Right side view	23
Fig. 8: Front side view config. with removable drives	23

Fig. 9: Front side view config. without removable drives	23
Fig. 10: Left side view	23
Fig. 11: Top side view	23
Fig. 12: Rear side view	23
Fig. 13: KBox C-101-2	24
Fig. 14: KBox C-101-2 with fan tray	24
Fig. 15: KBox C-101-1	24
Fig. 16: KBox C-101-1 with fan tray	24
Fig. 17: KBox C-101-0	24
Fig. 18: X 101 – 24 VDC power input connector	25
Fig. 19: SDCARD slot	26
Fig. 20: SD card (not included)	26
Fig. 21: Detail - Power button and PWR LED/Rescue button and RSQ LED	27
Fig. 22: Detail - Status and General Purpose LEDs	28
Fig. 23: X 205 – Location for the optional FIELDBUS interface	28
Fig. 24: PCIe 1 and PCIe 2 slots (shown as detail of a KBox C-101-2)	29
Fig. 25: Drive 1 and Drive 2 for removable 2.5" SATA HDD/SSD (option); closed drive bays	30
Fig. 26: Drive bay 1 with opened drive bay cover	30
Fig. 27: Inserting/removing a 2.5" removable SSD	30
Fig. 28: Right side of the KBox C-101 system	32
Fig. 29: Left side of the KBox C-101 system	32
Fig. 30: Top side of the KBox C-101 system	32
Fig. 31: Bottom side of the KBox C-101 system	32
Fig. 32: Rear side of the KBox C-101-2 system	33
Fig. 33: KBox C-101-2 shown with optional interfaces and with removable drive bays	34
Fig. 34: KBox C-101-2 shown with optional interfaces and without removable drive bays	34
Fig. 35: KBox C-101-1 equipped with the optional fan tray	36
Fig. 36: Fan tray components of the KBox C-101-1/-2 (cable connections between fan and fan connector are included in this assembly)	37
Fig. 37: Inside of the top cover with centering and fixing brackets	39
Fig. 38: This movement allows you to remove the centering and fixing bracket of the top cover (detail of the KBox C-101-2)	40
Fig. 39: Removing the cover (detail of the KBox C-101-2)	40
Fig. 40: KBox C-101-2 - removing the right side cover	41
Fig. 41: KBox C-101-2 without top and right side cover (shown with a PCIe riser card)	41
Fig. 42: KBox C-101-2 - internal view (shown with a PCIe riser card and removable HDD/SSD drive bay)	42
Fig. 43: KBox C-101-2 - internal view with COMExpress® module and with PCIe riser card	43

Fig. 44: Detail of the KBox C-101-2 with PCIe riser card with 2x PCIe x4 sockets	45
Fig. 45: Detail of the KBox C-101-2 with PCI-PCIe riser card with 1x PCI (32 bit) and 1x PCIe x4 sockets	45
Fig. 46: Keep out area for mounting around KBox C-101-2 (front side view without fan tray)	50
Fig. 47: Keep out area for mounting around KBox C-101-2 (front side view with optional fan tray)	50
Fig. 48: Keep out area for mounting around KBox C-101-1 (front side view without fan tray)	51
Fig. 49: Keep out area for mounting around KBox C-101-1 (front side view with optional fan tray)	51
Fig. 50: Keep out area for mounting around KBox C-101-0	52
Fig. 51: Phoenix power plug terminal	53
Fig. 52: Lithium battery polarity	57
Fig. 53: Fan tray extension (detail: shown as KBox C-101-1)	59
Fig. 54: KBox C-101-2 with removed fan tray and removed air filter	60
Fig. 55: Holder without air filter	60
Fig. 56: Holder (shown for a KBox C-101-2) with air filter	60
Fig. 57: Air filter (shown for a KBox C-101-2)	60
Fig. 58: KBox C-101-2 - front view (shown with removable drive bays and without mounting brackets)	61
Fig. 59: Block Diagram - KBox C-101-2	62
Fig. 60: KBox C-101-1 - front view (shown with removable drive bay without mounting brackets)	63
Fig. 61: Block Diagram - KBox C-101-1	64
Fig. 62: Inside of the KBox C-101-1 (shown with a removable HDD)	65
Fig. 63: KBox C-101-0 - front view (shown without mounting brackets)	68
Fig. 64: Block Diagram - KBox C-101-0	69
Fig. 65: KBox C-101-0 - internal view with the internal HDD/SSD drive	70
Fig. 66: Dimensions: Right side (KBox C-101-2)	72
Fig. 67: Dimensions: Front side with keyholes (KBox C-101-2)	72
Fig. 68: Dimensions: Keyhole in detail (KBox C-101-2)	72
Fig. 69: Dimensions: top side (KBox C-101-2)	72
Fig. 70: Dimensions: Right side (KBox C-101-2 with fan tray option)	73
Fig. 71: Dimensions: Front side with keyholes (KBox C-101-2 with fan tray option)	73
Fig. 72: Dimensions: Keyhole in detail (KBox C-101-2 with fan tray option)	73
Fig. 73: Dimensions: Top side (KBox C-101-2 with fan tray option)	73
Fig. 74: Dimensions: right side (KBox C-101-1)	75
Fig. 75: Dimensions: Front side with keyholes (KBox C-101-1)	75
Fig. 76: Dimensions: Keyhole in detail (KBox C-101-1)	75
Fig. 77: Dimensions: Top side (KBox C-101-1)	75
Fig. 78: Dimensions: Right side (KBox C-101-1 with fan tray option)	76
Fig. 79: Dimensions: Front side with keyholes (KBox C-101-1 with fan tray option)	76

Fig. 80: Dimensions: Keyhole in detail (KBox C-101-1 with fan tray option) 76

Fig. 81: Dimensions: Top side (KBox C-101-1 with fan tray option)..... 76

Fig. 82: Dimensions: Right side (KBox C-101-0) 78

Fig. 83: Dimensions: Front side with keyholes (KBox C-101-0) 78

Fig. 84: Dimensions: Keyhole in Detail(KBox C-101-0) 78

Fig. 85: Dimensions: top side (KBox C-101-0) 78

2. Introduction

Kontron would like to point out that the information contained in this manual may be subject to technical alteration, particularly as a result of the constant upgrading of Kontron products. The attached documentation does not entail any guarantee on the part of Kontron with respect to technical processes described in the manual or any product characteristics set out in the manual. Kontron does not accept any liability for any printing errors or other inaccuracies in the manual unless it can be proven that Kontron is aware of such errors or inaccuracies or that Kontron is unaware of these as a result of gross negligence and Kontron has failed to eliminate these errors or inaccuracies for this reason. Kontron expressly informs the user that this manual only contains a general description of technical processes and instructions which may not be applicable in every individual case. In cases of doubt, please contact Kontron.

This manual is protected by copyright. All rights are reserved by Kontron. Copies of all or part of this manual or translations into a different language may only be made with the prior written consent of Kontron. Kontron points out that the information contained in this manual is constantly being updated in line with the technical alterations and improvements made by Kontron to the products and thus this manual only reflects the technical status of the products by Kontron at the time of printing.

© 2015 by Kontron Europe

Printing and duplication, even of sections, is only permissible with the express approval of





Kontron Europe GmbH

Lise-Meitner-Str. 3-5

86156 Augsburg

Germany

2.1. Symbols used in this Manual

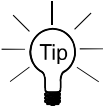
Symbol	Meaning
	This symbol indicates the danger of injury to the user or the risk of damage to the product if the corresponding warning notices are not observed.
	This symbol indicates that the product or parts thereof may be damaged if the corresponding warning notices are not observed.
	This symbol indicates general information about the product and the user manual.
	This symbol indicates detailed information about the specific product configuration.
	This symbol precedes helpful hints and tips for daily use.

2.2. Information about the System Designation and Description in this Manual

This manual includes description and specifications for the KBox C-101 Family product line.

2.2.1. Product Variants of the KBox C-101 Family

Used Designation	
KBox C-101	Description is valid for all variants
KBox C-101-2	Description is valid only for KBox C-101-2 (configuration with two rows for PCIe slots and DRIVES)
KBox C-101-2 with fan tray	Description is valid only for KBox C-101-2 systems (configuration with two rows for PCIe slots and DRIVES) The system is equipped with the optional fan tray
KBox C-101-1	Description is valid only for KBox C-101-1 systems (configuration with one row for PCIe slot and DRIVE)
KBox C-101-1 with fan tray	The description of the fan tray is like this one for KBox C-101-2. The mechanical fan tray components are the same, but with corresponding dimensions for KBox C-101-1.
KBox C-101-0	Description is valid only for KBox C-101-0 systems (without any row for PCIe slot and DRIVE)

	For the different KBox C-101 configurations refer also to chapter 17 "Technical Specifications" and section 7.4 "Front Side Configuration and Options - KBox C-101".
---	--

3. Important Instructions

Prior performing any installation or commissioning work with the device, this manual must be read carefully to become familiar with the device. The general safety instructions and information apply to all Kontron equipment for industrial control applications.

This manual provides important information required for the proper operation of the KBox C-101!
This chapter contains instructions which must be observed when working with the KBox C-101.

3.1. Obligation of Diligence

The operator must ensure that industrial PCs of the KBox Series are only used in control cabinet environments, the operation manual is understood and the personnel has the necessary authorization and regularly training about relevant standards, regulations and instructions.

Further the operator must ensure that the industrial PC is mounted, operated and maintained according to the instruction of this manual.

Depending on the target application the operator must observe the current applicable national and international regulations and standards.

3.2. Personnel

Only personnel with appropriate qualifications, trainings and authorization are permitted to install and work with the Kontron KBox C-101 industrial PC.

All applicable technical standards, regulations and guidelines for the installation and usage of the device must be understood and followed. Further accident prevention regulations and directives must be observed.

Every user of this system must be familiar with the instructions described in this manual.

3.3. Appropriate Use, Field of Application

The KBox C-101 is to be used in control cabinet applications only. Necessary fire enclosures and similar safety measures are to be provided by the control cabinet. The operator must ensure that the place of installation complies with applicable national and international standards and regulations.

3.4. Warranty Note

Due to their limited service life, parts which by their nature are subject to a particularly high degree of wear (wearing parts) are excluded from the warranty beyond that provided by law. This applies e.g., to battery, buffer battery and/or storage media like SD card.

3.5. Exclusion of Accident Liability Obligation

Kontron shall be exempted from the statutory accident liability obligation if the user fails to observe the included document: "General Safety Instructions for IT Equipment" the hints in this manual or eventually the warning signs label on the device.

3.6. Liability Limitation / Exemption from the Warranty Obligation

In the event of damage to the device caused by failure to observe the "General Safety Instructions for IT Equipment" in this manual or eventually the warning signs label on the device, Kontron shall not be required to honor the warranty even during the warranty period and shall be exempted from the statutory accident liability obligation.

4. General Safety Instructions for IT Equipment



Please read this chapter carefully and take careful note of the instructions, which have been compiled for your safety and to ensure to apply in accordance with intended regulations. If the following general safety instructions are not observed, it could lead to injuries to the operator and/or damage of the product; in cases of nonobservance of the instructions Kontron is exempt from accident liability, this also applies during the warranty period.

The product has been built and tested according to the basic safety requirements for low voltage (LVD) applications and has left the manufacturer in safety-related, flawless condition. To maintain this condition and to also ensure safe operation, the operator must not only observe the correct operating conditions for the product but also the following general safety instructions:

- The product must be used as specified in the product documentation, in which the instructions for safety for the product and for the operator are described. These contain guidelines for setting up, installation and assembly, maintenance, transport or storage.
- The on-site electrical installation must meet the requirements of the country's specific local regulations.
- If a power cable comes with the product, only this cable should be used. Do not use an extension cable to connect the product.
- To guarantee that sufficient air circulation is available to cool the product, please ensure that the ventilation openings are not covered or blocked. If an air filter is provided, this should be cleaned regularly. Do not place the system close to heat sources or damp places. Make sure the system is well ventilated.
- Only devices or parts which fulfill the requirements of SELV circuits (Safety Extra Low Voltage) as stipulated by IEC 60950-1 may be connected to the available interfaces.
- Before opening the device, make sure that the device is disconnected from the mains.
- Switching off the device by its power button does not disconnect it from the mains. Complete disconnection is only possible if the power cable is removed from the wall plug or from the device. Ensure that there is free and easy access to enable disconnection.
- The device may only be opened for the insertion or removal of add-on cards (depending on the configuration of the system). This may only be carried out by qualified operators.
- If extensions are being carried out, the following must be observed:
 - all effective legal regulations and all technical data are adhered to
 - the power consumption of any add-on card does not exceed the specified limitations
 - the current consumption of the system does not exceed the value stated on the product label.
- Only original accessories that have been approved by Kontron can be used.
- Please note: safe operation is no longer possible when any of the following applies:
 - the device has visible damages or
 - the device is no longer functioningIn this case the device must be switched off and it must be ensured that the device can no longer be operated.

Additional safety instructions for DC power supply circuits

- ❑ To guarantee safe operation of devices with DC power supply voltages larger than 60 volts DC or a power consumption larger than 240 VA, please observe that:
 - the device is set up, installed and operated in a room or enclosure marked with "RESTRICTED ACCESS", if there are no safety messages on product as safety signs and labels on the device itself.
 - no cables or parts without insulation in electrical circuits with dangerous voltage or power should be touched directly or indirectly
 - a reliable protective earthing connection is provided
 - a suitable, easily accessible disconnecting device is used in the application (e.g. overcurrent protective device.), if the device itself is not disconnectable
 - a disconnect device, if provided in or as part of the equipment, shall disconnect both poles simultaneously
 - interconnecting power circuits of different devices cause no electrical hazards
- ❑ A sufficient dimensioning of the power cable wires must be selected – according to the maximum electrical specifications on the product label – as stipulated by EN60950-1 or VDE0100 or EN60204 or UL508 regulations.
- ❑ The devices do not generally fulfill the requirements for "centralized DC power systems" (UL 60950-1, Annex NAB; D2) and therefore may not be connected to such devices!



4.1. Electrostatic Discharge (ESD)

A sudden discharge of electrostatic electricity can destroy static-sensitive devices or micro-circuitry. Proper packaging and grounding techniques are necessary precautions to prevent damage. Always take the following precautions:

1. Transport boards in static-safe containers such as boxes or bags.
2. Keep electrostatic sensitive parts in their containers until they arrive at the ESD-safe workplace.
3. Always be properly grounded when touching a sensitive board, component, or assembly.
4. Store electrostatic-sensitive boards in protective packaging or on antistatic mats.

4.1.1. Grounding Methods



The following measures help to avoid electrostatic damages to the device:

1. Cover workstations with approved antistatic material. Always wear a wrist strap connected to workplace as well as properly grounded tools and equipment.
2. Use anti-static mats, heel straps, or air ionizers to give added protection.
3. Always handle electrostatic sensitive components by their edge or by their casing.
4. Avoid contact with pins, leads, or circuitry.
5. Turn off power and input signals before inserting and removing connectors or connecting test equipment.
6. Keep work area free of non-conductive materials such as ordinary plastic assembly aids and styrofoam.
7. Use field service tools such as cutters, screwdrivers, and vacuum cleaners which are conductive.
8. Always place drives and boards PCB-assembly-side down on the foam.

4.2. Instructions for the Lithium Battery

If ordered, your KBox C-101 is equipped with a lithium battery (externally-accessible); refer to section 7.2 "Optional RTC Lithium Battery (externally accessible)".

When replacing the lithium battery, please follow the corresponding instructions in section 13.1 "Replacing the Lithium Battery".

	<p>Caution</p> <p>Danger of explosion when replacing with wrong type of battery. Replace only with the same or equivalent type recommended by the manufacturer. The lithium battery type must be UL recognized.</p>
	<p>Do not dispose of lithium batteries in general trash collection. Dispose of the battery according to the local regulations dealing with the disposal of these special materials, (e.g. to the collecting points for dispose of batteries).</p>

5. Electromagnetic Compatibility (Class B Device)

5.1. Electromagnetic Compatibility (EU)

This product complies with the European Council Directive on the approximation of the laws of the member states relating to electromagnetic compatibility (2004/108/EC), Class B limits for Information Technology Equipment according to European Standard EN 55022.

5.2. FCC Statement (USA)

The following statement applies to the products covered in this manual, unless otherwise specified herein. The statement for other products will appear in the accompanying documentation.

This equipment has been tested and found to comply with the limits for a Class B digital device, pursuant to Part 15 of the FCC Rules. These limits are designed to provide reasonable protection against harmful interference in a residential installation. This equipment generates, uses and can radiate radio frequency energy and, if not installed and used in accordance with the instructions, may cause harmful interference to radio communications. However, there is no guarantee that interference will not occur in a particular installation.

If this equipment does cause harmful interference to radio or television reception, which can be determined by turning the equipment off and on, the user is encouraged to try to correct the interference by one or more of the following measures:

- Reorient or relocate the receiving antenna.
- Increase the separation between the equipment and receiver.
- Connect the equipment into an outlet on a circuit different from that to which the receiver is connected.
- Consult the dealer or an experienced radio/TV technician for help.

Kontron Europe GmbH is not responsible for any radio television interference caused by unauthorized modifications of this equipment or the substitution or attachment of connecting cables and equipment other than those specified by Kontron Europe GmbH. The correction of interference caused by such unauthorized modification, substitution or attachment will be the responsibility of the user.

The use of shielded I/O cables is required when connecting this equipment to any and all optional peripheral or host devices. Failure to do so may violate FCC and ICES rules.

5.3. EMC-Compliance (Canada)

The method of compliance is self-declaration to Canadian ICES-003:

(English): This Class B digital apparatus complies with the Canadian ICES-003.

(French) : Cet appareil numérique de la class B est conforme à la norme NMB-003 du Canada.

6. Shipment and Unpacking

6.1. Unpacking

Proceed as follows to unpack the unit:

1. Remove packaging.
2. Do not discard the original packaging. Keep it for future relocation.
3. Check the delivery for completeness by comparing it with your order.
4. Please keep the associated paperwork. It contains important information for handling the unit.
5. Check the contents for visible shipping damage.
6. If you notice any shipping damage or inconsistencies between the contents and your order, please contact Kontron for help and information.

6.2. Scope of Delivery

- KBox C-101 (corresponding to the ordered system configuration)
- POWER-SUBCON PSC 1,5/ 3-F, 3-pin plug
- General Safety Instructions for IT Equipment

6.2.1. Optional Parts (System Expansion)

- Front accessible drive bays for 2.5" SATA HDD/SSDs
- Mini-PCIe cards
- mSATA cards (M0-300)
- PCIe cards

6.2.2. Optional System Extension

- RS232/RS422 port: via internal factory mounted and configured RS232/RS422 adapter module
- CAN port: via internal factory mounted CAN adapter module
- DVI-D (single Link) port or DisplayPort (via internal factory mounted adapter modules)
- Optional externally accessible RTC lithium battery
- Optional system expansion with fan tray



Please observe the different configuration options for each system of the KBox C-101 family. Refer to chapter 17 "Technical Specifications" and the descriptions in this manual.

6.3. Spare Parts

The following spare parts are available for field replacement:

Spare Part	Part Number	
	KBox C-101-2	KBox C-101-1
Fan tray	1055-4009	1056-7503
Air filter	1055-4670	1056-7507

6.4. Type Label and Product Identification

The type label (product name, serial number, part number, production date) of your KBox C-101 system is located on the right side of the device (refer to Fig. 1 and Fig. 28, pos. 9).



Fig. 1: Example of KBox C-101 type label

System Type	Product Designation	Product Identification
KBox C	KBox C-101	<p>KBox C-101-2: corresponds for system configurations with two slot rows for the optional removable DRIVES and/or PCIe expansion slots</p> <p>KBox C-101-1: corresponds for system configurations with one slot row for the optional removable DRIVE and/or PCIe expansion slot</p> <p>KBox C-101-0: corresponds for system configuration without any slot row for the optional removable DRIVE and PCIe expansion slot</p>

7. System Overview

The KBox C-101 Family is a highly scalable and flexible industrial computer platform that offers high-end performance for industrial automation application such as control or process monitoring.

The performance scalability is achieved by deploying various Kontron COMExpress® CPU modules (from factor basic and type 6 pinout) inside the system.

The system flexibility is a result of the basic design concept of using a baseboard which provides the COMExpress® and a set of standard IO interfacing plus a comprehensive optionally available IOs and devices.

The KBox C-101 offers a maintenance free (wartungsfrei) operation. That means it operates without battery, fans and rotating media (HDD).

The KBox C-101 family comprises three different chassis versions:

- ❑ The KBox C-101-2 with two PCI/PCIe expansion slots and spaces for up to two 2.5" SATA SSDs/HDDs
- ❑ The KBox C-101-1 with one PCIe expansion slot and space for one 2.5" SATA SSD/HDD
- ❑ The KBox C-101-0 without PCIe expansion slot and space for one internal 2.5" SATA SSD/HDD



Fig. 2: KBox C-101 family

Standard Front Panel:

The following interfaces are available with the KBox C-101:

- 24 VDC input power (X101)
- 3x Gigabit Ethernet (X102, X103, X104)
- 2x USB 3.0 (X105, X106)
- 2x USB 2.0 (X107, X108)
- DisplayPort (X109)
- SD card slot (without X numbered slot)
- RS232 serial (X110)
- Buttons with corresponding LEDs:
 - RSQ (rescue)
 - PWR (power)
- LEDs:
 - GP1 to GP4 (general purpose LEDs)
 - THERM (thermal status)
 - DRIVE (SSD/HDD drive status)
 - SD (SDHC/SDXC status)
 - WD (Watchdog status)

Standard Baseboard - Onboard and System Expansion Capabilities:

- up to 2x SATA and power connector (for internal or removable devices, depending on the KBox C-101 configuration)
- 2x mSATA sockets
- 2x Mini PCIe x1 sockets (one socket is on the top side, the second one on the bottom side of the baseboard)
- 1x PCIe x8 socket for expansion via riser cards:
 - up to 2x PCIe x4 sockets on riser card (depending on the KBox C-101-2/-1 configuration) or
 - 1x PCI (32 bit) and 1x PCIe x4 sockets on riser card (available for KBox C-101-2 only)

Optional System Extension:

- RS232/RS422 port: via internal factory mounted and configured RS232/RS422 adapter module
- CAN port: via internal factory mounted CAN adapter module
- DVI-D port (single Link) or DisplayPort (via corresponding internal factory mounted adapter modules)
- Optional external accessible RTC lithium battery
- Optional system extension with fan tray (not possible for KBox C-101-0)

The KBox C-101 is a fanless system with a compact aluminum chassis with cooling fins.

The rated voltage range of the mains can be found on the type label. The type label is located at the right side of the device (Fig. 28, pos. 9).



The KBox C-101 is designed to be operated wall mounted inside a control cabinet, in vertical position, except with the top side facing down.

When you power on the KBox C-101, make sure that the air exhaust openings on the top side (Fig. 30, pos. 12), the air intake openings on the bottom side (Fig. 31, pos. 11) and the cooling fins of the chassis (Fig. 29, Fig. 30 and Fig. 31, pos. 6) are not obstructed (covered) by any objects.

To provide sufficient heat dissipation via the cooling fins of the device, do not cover the cooling fins of the KBox C-101. Do not place any objects on the device. When installing the system, please observe the clearance recommendation (keep out area) in subsection 11.1 "Control Cabinet Mounting"; refer to the marked areas in Fig. 46 to Fig. 50.

7.1. RTC (GoldCap)

The baseboard of the KBox C-101 provides an "external RTC" module connected via the SMBus. An RTC module of type RV-8564 or compatible is used. To provide a valid date and time when no power is connected to the system, the RTC module is equipped with a goldcap buffer.

7.1.1. RTC Buffer Time

The RTC buffer time is depending of the ambient temperature. For a better understanding of the differing behavior of the goldcap buffer integrated in your system, refer to the diagram below:

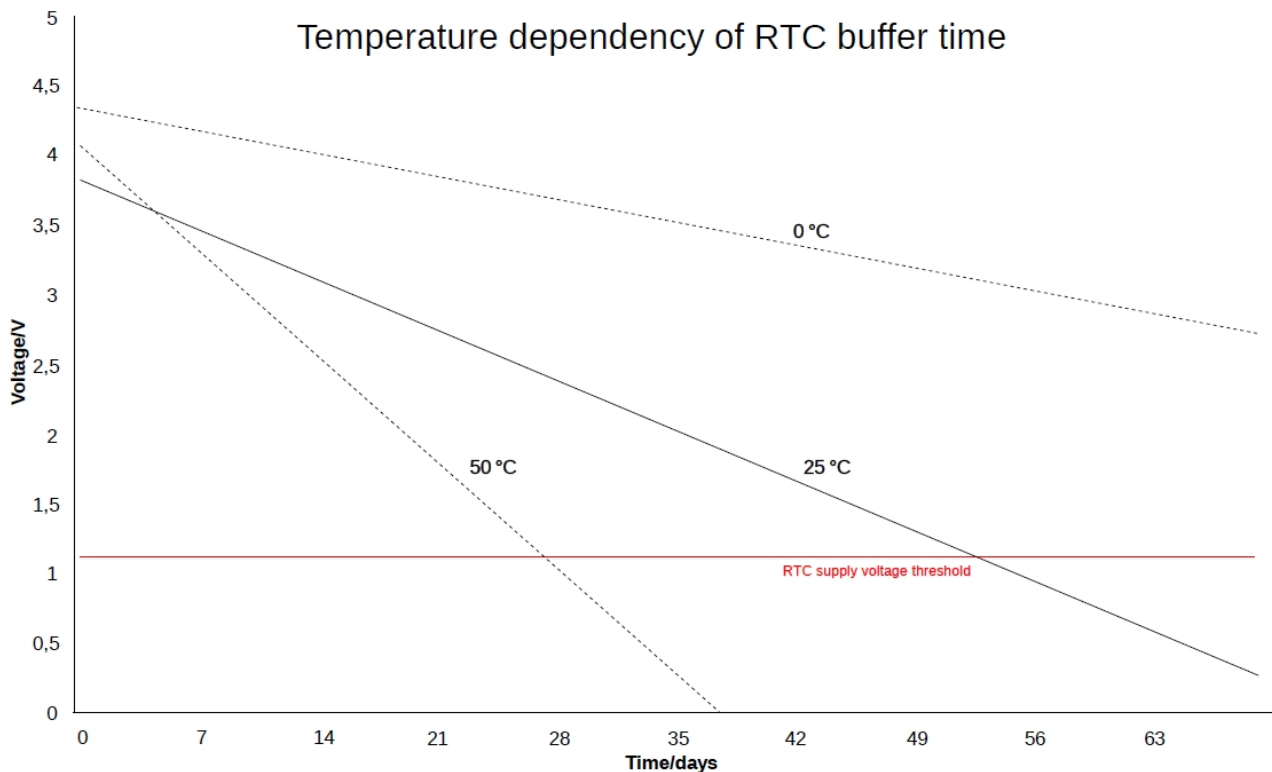

Fig. 3: RTC buffer time depending on temperature

If the time is not valid this is indicated by a status bit in the RTC registers. For details see the RV-8564 application manual.



To get the maximum buffer time, it is necessary to have the system a certain time powered on. This ensures that the buffer capacitors are fully loaded.

The buffer time depends on the ambient temperature and on how long the system is connected to the power supply.

7.1.2. Setting the RTC

During startup, the uEFI performs a comparison of chipset clock and "external RTC" module and sets the chipset clock accordingly, if the RTC time is valid. Further it is possible to set the time manually by accessing the RTC over the SMBus.

7.2. Optional RTC Lithium Battery (externally accessible)

Your KBox C-101 can be optionally equipped with an externally-accessible lithium battery (CMOS) (Fig. 5, pos. 3). The battery and the battery holder are covered by a protective cover (refer to Fig. 4, pos. 1) secured by a Philips countersunk head screw (Fig. 4, pos. 2).

When replacing the lithium battery, please follow the corresponding instructions in section 13.1 “Replacing the Lithium Battery”.

	<p>The protective cover of the KBox C-101 with externally-accessible lithium battery must always be installed during transportation and operation activities.</p> <p>The protective cover should be removed only when you attempt to replace the lithium battery.</p>
	<p>If your system is equipped with the externally battery (option) pay attention to the manufacturer specifications for storage/transit temperature (non operating) in section 17.2 “Environmental Specifications”.</p>

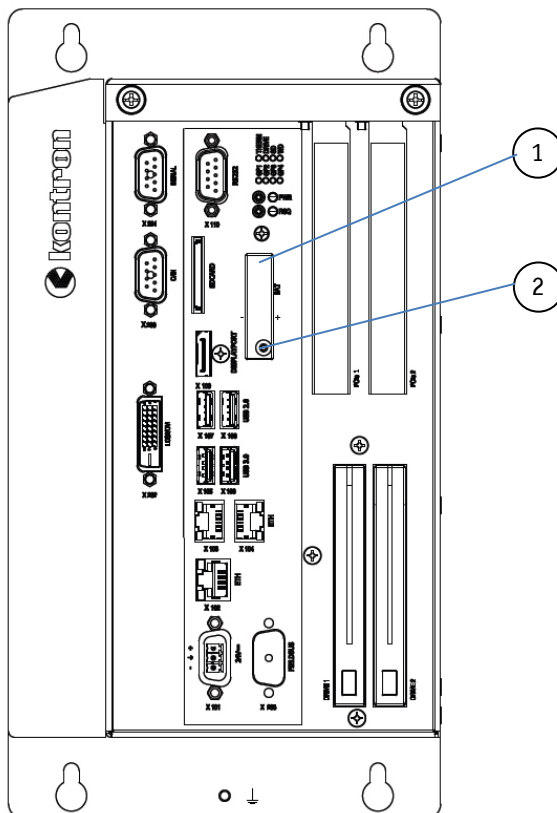

Fig. 4: Lithium battery location (shown with protective cover)

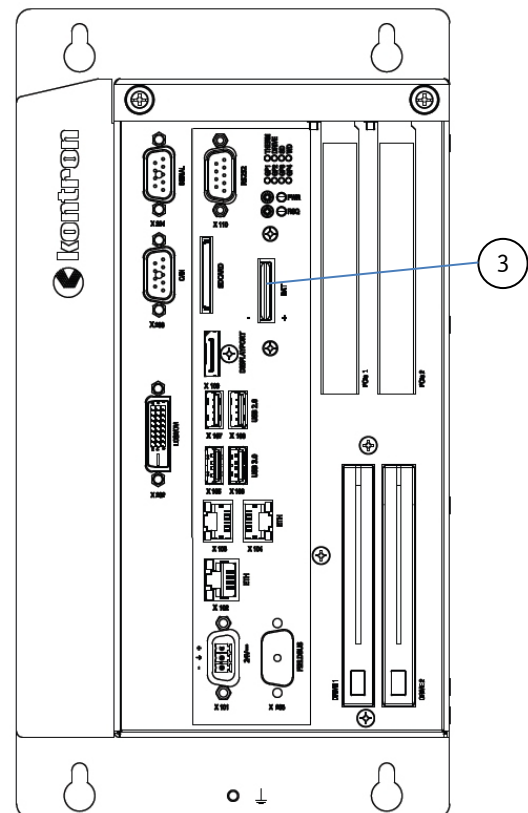

Fig. 5: Lithium battery location (externally accessible battery shown with removed protective cover)

Legend for Fig. 4 and Fig. 5:

- 1 Protective cover for the lithium battery
- 2 Philips countersunk head screw that secures the protective cover at the front side of the chassis
- 3 Externally accessible battery shown with removed protective cover

7.3. System Expansion Capabilities

For the configuration of your KBox C-101 please follow the ordering options specified in: "Configuration Guides – KBox C-101" on our web site www.kontron.com.

7.3.1. Mini PCI Express® Interfaces

There are two Mini PCIe interfaces on the KBox C-101 baseboard.

One Mini PCIe interface connector is accessible from the top side of the KBox C-101 when the top cover is removed.

The second Mini PCIe interface connector is located on the bottom side of the baseboard and is not accessible in the field. This interface connector is intended to be used for the Fieldbus expansion. If a customer requires this system expansion, it must be selected when ordering, as this expansion has to be carried-out at factory.

Refer also to subsections 9.3.3 and 9.3.6.

Refer to chapter 17 "Technical Specifications" and the descriptions in this manual.

7.3.2. mSATA (MO-300)

The baseboard of the KBox C-101 provides two mSATA interfaces.

These allow you to equip your system with mSATA SSDs. Refer to subsections 9.3.2 and 9.3.7.

Refer to chapter 17 "Technical Specifications" and the descriptions in this manual.

7.3.3. Standard PCI Express® Interfaces

The baseboard of KBox C-101 provides 1x PCIe x8 interface.

Via riser cards there are available PCI/PCIe expansion possibilities as shown in chapter 7.4 (area marked "C").



Please observe the different configuration options regarding the PCI/PCIe cards installation, for each system variant of the KBox C-101 family.

Refer to chapter 17 "Technical Specifications" and the descriptions in this manual.

7.3.4. SATA Interfaces

The baseboard of KBox C-101 provides two SATA interfaces. These allow the installation of up to two internal 2.5" SATA HDDs/SSDs or optional front accessible drive bays for 2.5" SATA HDDs/SSDs (refer to subsection 7.4.13 "Internal or Removable 2.5" SATA HDDs/SSDs").



Please observe the different configuration options, regarding the installation of 2.5" SATA HDD/SSD devices, for each system of the KBox C-101 family (refer to the area marked "D" in section 7.4).

Refer to chapter 17 "Technical Specifications" and the descriptions in this manual.

Fig. 6 to Fig. 12: Views of a KBox C-101-2

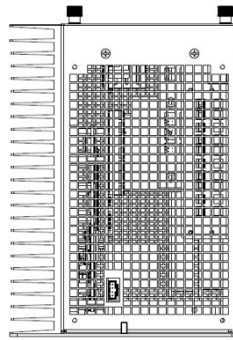

Fig. 6: Bottom side view

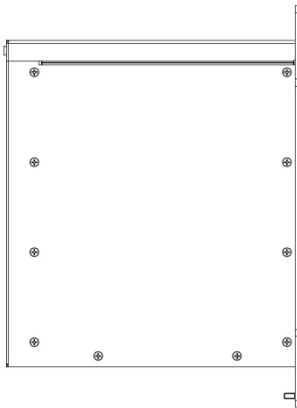

Fig. 7: Right side view



Fig. 8: Front side view config. with removable drives

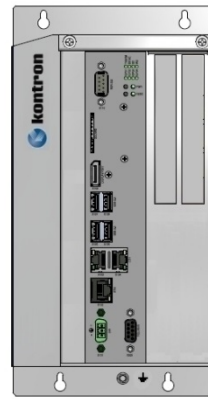

Fig. 9: Front side view config. without removable drives

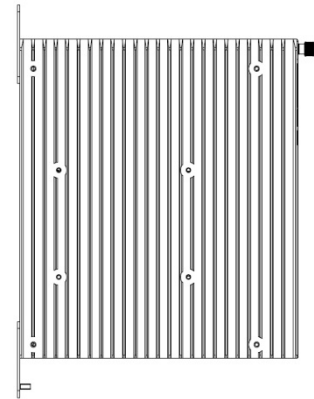

Fig. 10: Left side view

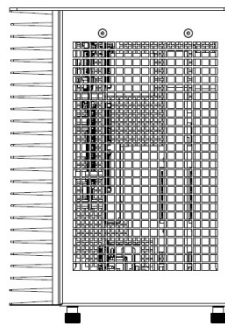

Fig. 11: Top side view

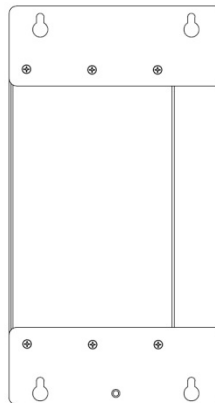

Fig. 12: Rear side view

7.4. Front Side Configuration and Options - KBox C-101

A	Standard Interfaces	KBox C-101-2		KBox C-101-1		KBox C-101-0	
	Power input connector (X 101)	1x		1x		1x	
	Ethernet (X 102/X103/X 104)	3x		3x		3x	
	USB 3.0 (X 105/X 106)	2x		2x		2x	
	USB 2.0 (X 107/X 108)	2x		2x		2x	
	DisplayPort (X 109)	1x		1x		1x	
	SD card Slot	1x		1x		1x	
	RS232 (X 110)	1x		1x		1x	
	FIELDBUS (X 205); option – factory-installed only	1x		1x		1x	
B	Extension Capabilities (Options)						
	CAN Port (X203)	1x		1x		1x	
	RS232/RS422 port (X204)	1x		1x		1x	
	DVI-D port (X202)	1x	-	1x	-	1x	-
	DisplayPort (DP 2) (X202)	-	1x	-	1x	-	1x
C	PCI/PCIe Expansions via corresponding Riser Cards (Options)						
	PCIe 1 Slot	PCIe x4 socket		1x		1x	
	PCIe 2 Slot	PCIe x4 socket		1x	-		
		PCI (32 bit) socket		-	1x		
D	Internal or externally accessible 2.5" SATA HDD/SSD (Options)						
	Internal 2.5" SATA HDD/SSD	2x	-	1x	-	1x	-
	Removable drive bay for 2.5" SATA HDD/SSD (DRIVE 1)	-	1x	1x	-	-	-
	Removable drive bay for 2.5" SATA HDD/SSD (DRIVE 2)	-	1x	-	-	-	-
E	Externally accessible CMOS Battery (Option)						
	CR 2025, 3V	1x		1x		1x	
F	Fan Tray (Option)						
	Fan tray	1x		1x		-	

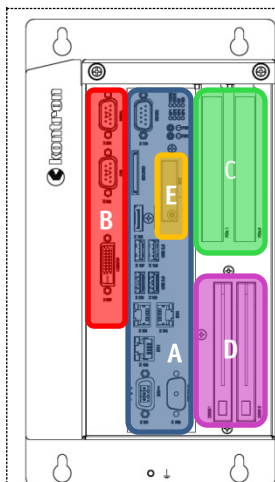

Fig. 13: KBox C-101-2

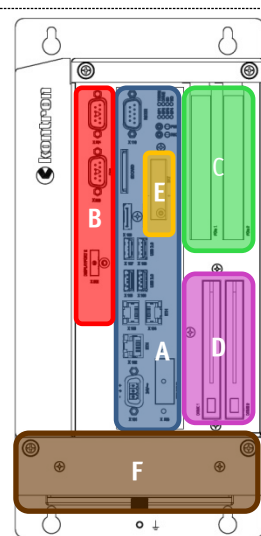

Fig. 14: KBox C-101-2 with fan tray

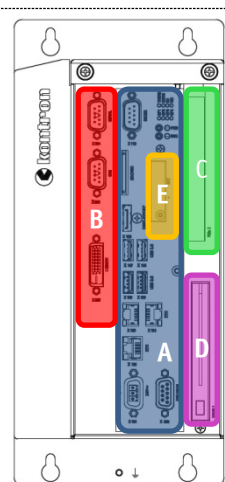

Fig. 15: KBox C-101-1

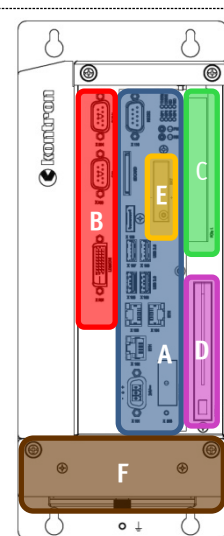

Fig. 16: KBox C-101-1 with fan tray

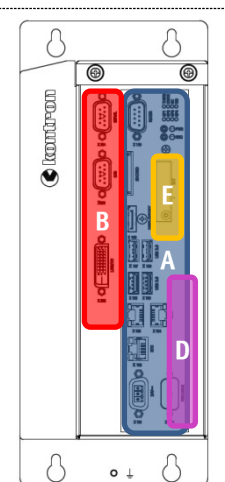

Fig. 17: KBox C-101-0

7.4.1. X 101 - Power Input Connector

The 3-pin connector (X 101, Fig. 18 and Fig. 58) provides the power connection of the KBox C-101 system to an appropriate DC main power supply. For pin assignments refer to subsection 18.1.1.

The external cable connector is a Phoenix PSC 1,5/ 3-M, 3-pin plug with an SCT-D-SUB 9-KG housing. This power plug is delivered along with the KBox C-101. Please observe section 12.1 "Connecting to DC Main Power Supply". The mating connector is a Phoenix PSC 1,5/ 3-F connector.

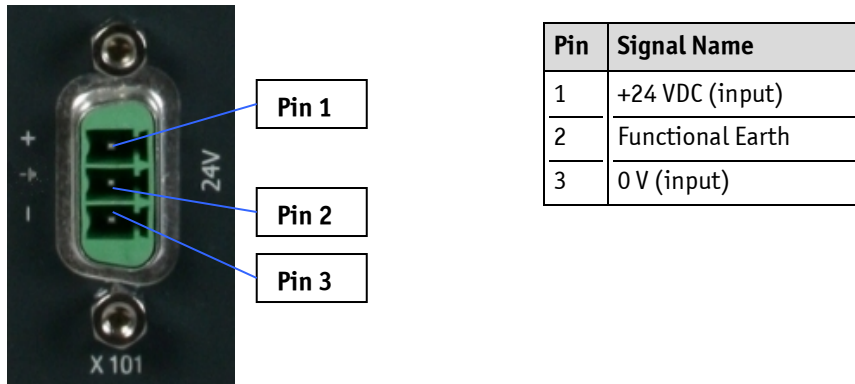

Fig. 18: X 101 - 24 VDC power input connector

7.4.2. X 102/X 103/X 104 - Ethernet Connectors (ETH)

These connectors (X 102/X 103/X 104, Fig. 58, Fig. 60 and Fig. 63) are Gigabit Ethernet 10/100/1000 Mbit/s, IEEE 1588 capable interfaces. The connectors are standard 8-pin RJ45 type connectors with status LEDs:

- Activity/link: green = link up; green blinking = activity.
- Speed: off, green, yellow (10/100/1000 Mbit/s).

For pin assignment refer to subsection 18.1.6.

7.4.3. X 105/X 106 - USB 3.0

The KBox C-101 provides two USB 3.0/2.0 interfaces. These connectors (X 105/X 106, Fig. 58, Fig. 60 and Fig. 63) allow connection of USB 3.0 or USB 2.0 compatible devices to the system.

For pin assignment refer to subsection 18.1.5.

7.4.4. X 107/X 108 - USB 2.0

The KBox C-101 provides two USB 2.0/1.1 interfaces. These connectors (X 107/X 108, Fig. 58, Fig. 60 and Fig. 63) allow connection of USB 2.0 or USB 1.1 compatible devices to the system.

For pin assignment refer to subsection 18.1.4.

7.4.5. X 109 - DisplayPort

It is a DisplayPort compliant interface realised using a standard DisplayPort connector. An external (digital) display can be connected to the DisplayPort connector (X 109, Fig. 58, Fig. 60 and Fig. 63).

For pin assignment refer to subsection 18.1.3.

7.4.6. SDCARD Slot

This slot, marked "SDCARD" is an SDHC/SDXC compliant interface realised using a standard SD card connector. It is accessible at the front side of the KBox C-101 (Fig. 58, Fig. 60 and Fig. 63) and is located between the serial interface (RS232/X 110) and DISPLAYPORT (X 109).

- ❑ This SD card reader supports SD, SDHC and SDXC cards.
- ❑ SD card activity is indicated by the SD LED on the KBox C-101 front side.
- ❑ This interface permits hot-plugging of the SD card. The system can also be booted from this interface.



Fig. 19: SDCARD slot



Fig. 20: SD card (not included)



This interface supports hot-plugging.

To prevent data loss when removing the SD/SDHC/SDXC card, it may not be removed during a read or write access [while the SD LED (Fig. 22) is flashing].

To install a card please perform following steps:

1. Insert the SD/SDHC/SDXC card into the SDCARD slot marked "SDCARD" (see Fig. 58 and Fig. 19) on the front side of the KBox C-101.
2. Gently push the card into the slot until it snaps into place. When the card was inserted correctly, the SD LED (Fig. 22) lights up.



Do not act with force when inserting the memory card. If the card is not inserted properly in the guide rails, remove the card from the slot and re-insert it with care.

3. The card is ready for use.

To remove a card, proceed as described below:

1. Gently push the SD/SDHC/SDXC card until it clicks.
2. Release the card and it will be partially ejected.
3. Pull the card out from the slot.

7.4.7. X 110 - RS232 Port

The RS232 interface (X 110, Fig. 58, Fig. 60 and Fig. 63) is provided as a 9-pin D-SUB connector. It allows you to connect a serial device to the system.

For pin assignment refer to subsection 18.1.2.

7.4.8. POWER Button and PWR LED

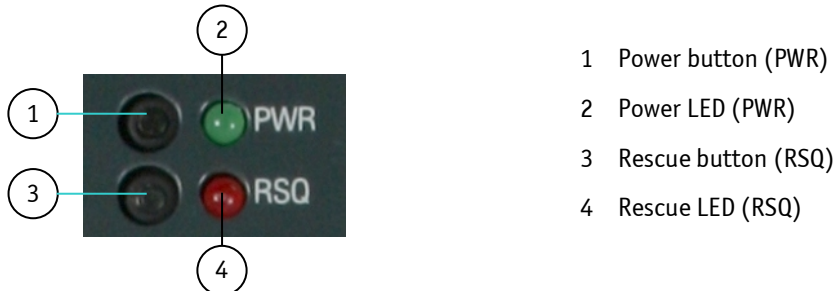

Fig. 21: Detail - Power button and PWR LED/Rescue button and RSQ LED

The power button (marked PWR in Fig. 21, pos. 1, Fig. 58, Fig. 60 and Fig. 63) is used to power the KBox C-101 on or off. By pressing the power button for longer than four seconds a forced system shutdown will be initiated, before the power to the system is turned off.



Caution!

Performing a forced shut down can lead to loss of data or other undesirable effects!

The power LED (marked PWR, Fig. 21, pos. 2, Fig. 58, Fig. 60 and Fig. 63) is on green steady when power is applied to the system.

Prerequisite:

The KBox C-101 has to be connected to an appropriate main power supply (DC).



Even when the system is turned off via the power button there are parts of the system still energized. The unit is only completely disconnected from the DC mains, when the power is removed.

As soon as external power is applied to the main input power connector, X 101 (Fig. 18), the KBox C-101 boots up and then starts the operating system and application where available.

To perform an orderly shutdown of the system, press the PWR button and the system shuts down under the control of the operating system.

Once the system has been shut down, it can be restarted by pressing the PWR button (assuming that power is still applied to the main input power connector, X 101).

7.4.9. RESCUE Button and RSQ LED



The rescue function is not intended for use with a system in an application environment. It is designed to be used if the standard BIOS flash is corrupted, in order to get the system to boot in a defined and safe state for further failure resolution.

The RESCUE button (marked RSQ in Fig. 21, pos. 3, Fig. 58, Fig. 60 and Fig. 63) is used to force using the backup flash for system booting.

The RESCUE LED (RSQ, Fig. 58, Fig. 21, pos. 4) blinks red when the backup flash is selected for booting. The backup flash contains a cloned BIOS (uEFI) version. In the event the system does not properly start-up or gets hung-up and restarting (cold booting) the system does not help, it is possible to switch to the backup boot flash and then restart the system. To do this, press the RSQ button for more than five seconds, whether or not the system is running it will now start-up using the backup flash for booting.

To revert to using the standard boot flash, the system must be cold started using the PWR button or remove power completely from the system and then reapply.

7.4.10. Status and General Purpose LEDs

After power is applied and the KBox C-101 performs the boot procedure, the LEDs show the POST code. In case of a boot failure within the uEFI the last post code is displayed. When the boot phase is passed without errors, the LEDs change to their status and general purpose function.

The following table provides information concerning these LEDs (Fig. 58 and Fig. 22).



Status and General Purpose LEDs			
Designator	Function	Color	Description
THERM	Thermal	Red blinking	The system turns off due to over temperature
DRIVE	Drives (SSD/HDD)	Green	SSD/HDD active
SD	SD Card	Green	SD card active
WD	Watchdog	Red blinking	Watchdog timeout occurred
GP1	General Purpose 1	Red/Green/Orange	User general purpose 1
GP2	General Purpose 2	Red/Green/Orange	User general purpose 2
GP3	General Purpose 3	Red/Green/Orange	User general purpose 3
GP4	General Purpose 4	Red/Green/Orange	User general purpose 4

Fig. 22: Detail - Status and General Purpose LEDs

7.4.11. X 205 - Optional FIELDBUS Interface



The optional interface (FIELDBUS) on the front side of the KBox C-101 must be ordered separately. To add a FIELDBUS interface to the system, the second mPCIe socket (on the bottom of the baseboard), will be used. This connection can be implemented at factory only.

Fig. 23: X 205 – Location for the optional FIELDBUS interface

7.4.12. PCI/PCIe Expansion Slot 1 and Slot 2

The KBox C-101 provides on the front side up to two slots (see "PCIe 1" and "PCIe 2" in Fig. 58 for KBox C-101-2 and "PCIe 1" for KBox C-101-1 in Fig. 60) for system expansion with PCI/PCIe expansion cards via corresponding riser cards.

To access the corresponding riser card sockets, in order to install or remove PCI/PCIe expansion cards (refer to subsection 9.3.4 "Riser Cards Expansion Sockets for PCI/PCIe Cards"), you have to remove the top side access cover. For a better accessibility of the expansion sockets you should remove the right side access cover (Fig. 30 and Fig. 28, pos. 1 and pos. 3) also.

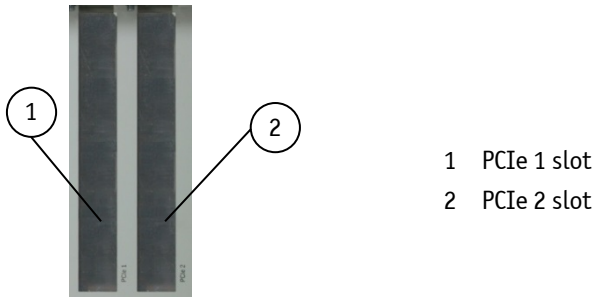

Fig. 24: PCIe 1 and PCIe 2 slots (shown as detail of a KBox C-101-2)



Please observe that:

KBox C-101-2: supports up to:

2x PCIe x4/PCIe x1 expansion cards **or**

1x PCIe x4/PCIe x1 and 1x PCI (32 bit) expansion cards.

For system configuration refer to Fig. 58, Fig. 59 and for expansion cards installation refer to subsection 9.3.5 "Installing/Removing the PCI/PCIe Expansion Cards".

KBox C-101-1: supports 1x PCIe x4/PCIe x1 expansion card.

For system configuration refer to Fig. 60, Fig. 61 and for expansion card installation the subsection 15.1.1 "PCIe Expansion Slot 1".

KBox C-101-0: can't be equipped with PCI/PCIe expansion cards. Refer to Fig. 63 and Fig. 64.

Refer also to the area marked "C" in section 7.4.

7.4.13. Internal or Removable 2.5" SATA HDDs/SSDs

Depending on the ordered system configuration, your KBox C-101-2 can be equipped with up two drive bays for 2.5" removable SATA HDDs/SSDs (refer to Fig. 58, Fig. 59 and Fig. 25) or one internal mounting frame for 2x 2.5" SATA HDDs/SSDs.

The internal 2.5" HDDs/SSDs are not accessible from the outside. The internal SATA HDDs/SSDs are installed (always factory installed) into the system by use of a mounting frame.

The 2.5" drive bays (DRIVE 1 and DRIVE 2) for removable HDDs/SSDs are accessible from the front side (Fig. 58) of the system (refer to Fig. 25, Fig. 26 and Fig. 27).

The drives support following drive speeds:

- ❑ DRIVE 1: up to SATA 6 Gb/s.
- ❑ DRIVE 2: up to SATA 3 Gb/s.



If the KBox C-101-2 configuration with internal 2.5" SATA HDDs/SSDs was ordered, the "DRIVE 1" and "DRIVE 2" for removable SATA HDDs/SSDs are not available (refer to Fig. 9).

If the KBox C-101-2 configuration with removable 2.5" SATA HDDs/SSDs was ordered, no installation of any internal SATA HDD/SSD (with mounting frame) is possible.

Refer also to the area marked "D" in section 7.4.



Fig. 25: Drive 1 and Drive 2 for removable 2.5" SATA HDD/SSD (option); closed drive bays

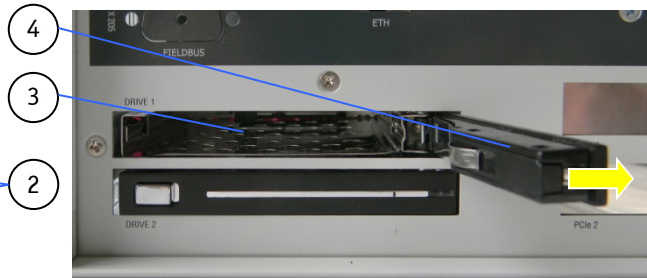

Fig. 26: Drive bay 1 with opened drive bay cover

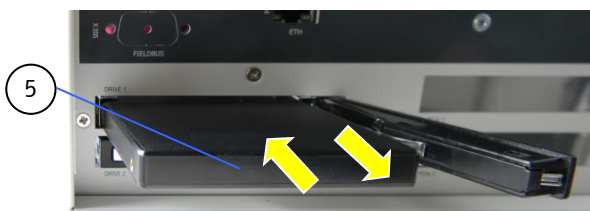

Fig. 27: Inserting/removing a 2.5" removable SSD



This SATA interface supports hot-swapping. To prevent data loss, don't remove the HDD during read/write activity [while the "DRIVE LED" (Fig. 22) is flashing green].

Legend for Fig. 25, Fig. 26 and Fig. 27:

- | | |
|---|---|
| 1 Slide button to release the drive bay cover | 4 Opened drive bay cover |
| 2 Cover of the drive bay | 5 Inserting or removing a 2.5" removable SATA HDD/SSD |
| 3 Drive bay for 2.5" removable SATA HDD/SSD | |



Please observe that the KBox C-101-1 system configuration can be equipped with only one internal or removable 2.5" SATA HDD/SSD. Refer to chapter 15 "KBox C-101-1 Variant" and subsection 15.1.2 "Internal or Removable 2.5" SATA HDD/SSD".

The KBox C-101-0 can be equipped with only one internal 2.5" SATA HDD/SSD. Refer to chapter 16 "KBox C-101-0 Variant" and subsection 16.1.1 "Internal 2.5" SATA Drive".

Refer also to the area marked "D" in section 7.4.

7.4.13.1. Installing/Removing the removable HDD/SSD

To install/remove a removable drive, please perform the following steps:

1. Slide the button (Fig. 25, pos. 1) of the drive cover (Fig. 25, pos. 2) to the right (this movement is upwards, on the system in vertical position) and release it. The drive bay cover will spring up.
2. Pull the drive cover up.
3. Insert/remove the drive into/out from the bay receptacle.
4. Close the cover.

7.5. Left and Right Side View

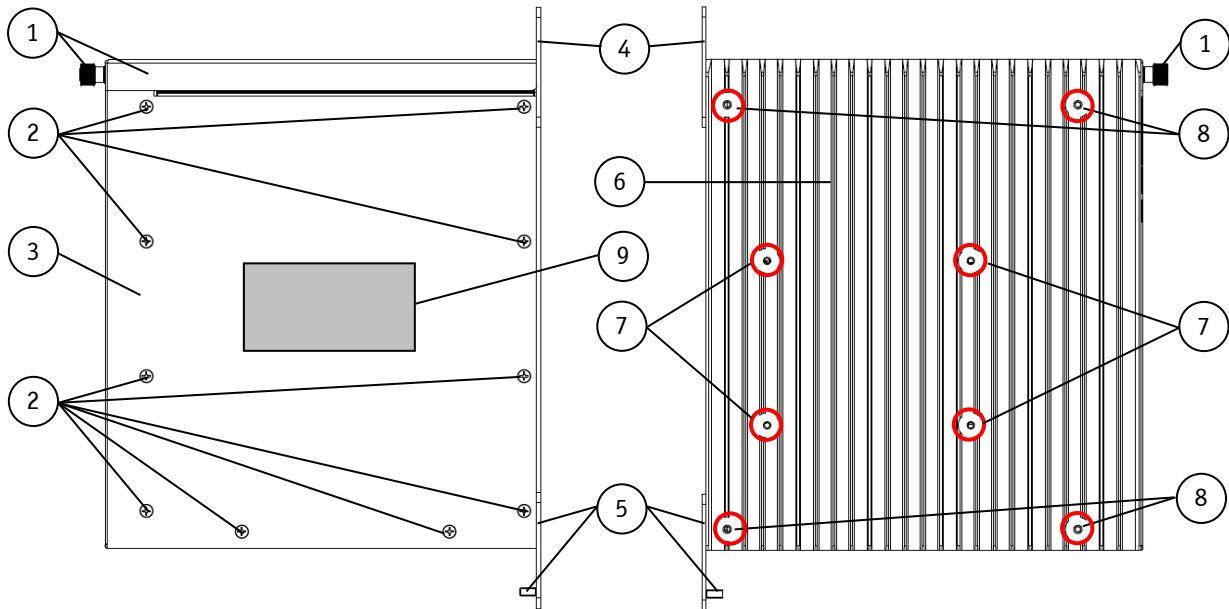

Fig. 28: Right side of the KBox C-101 system

Fig. 29: Left side of the KBox C-101 system

Legend for Fig. 28, Fig. 29, Fig. 30 and Fig. 31:

- | | |
|--|--|
| 1 Top side access cover with knurled screws | 7 Screws that secure the COMExpress® module |
| 2 10x screws that secure the right side access cover | 8 Screws that secure the cooling fins to the chassis |
| 3 Right side access cover | 9 Type label |
| 4 Upper mounting bracket with key holes | 10 Hole for further system fan tray extension |
| 5 Lower mounting bracket with M4 ground stud and key holes | 11 Air intake openings on the bottom cover |
| 6 Cooling fins of the chassis | 12 Air exhaust openings on the top cover |

Please do not remove the red marked screws (see Fig. 29, pos. 7 and pos. 8).

7.6. Top and Bottom Side View

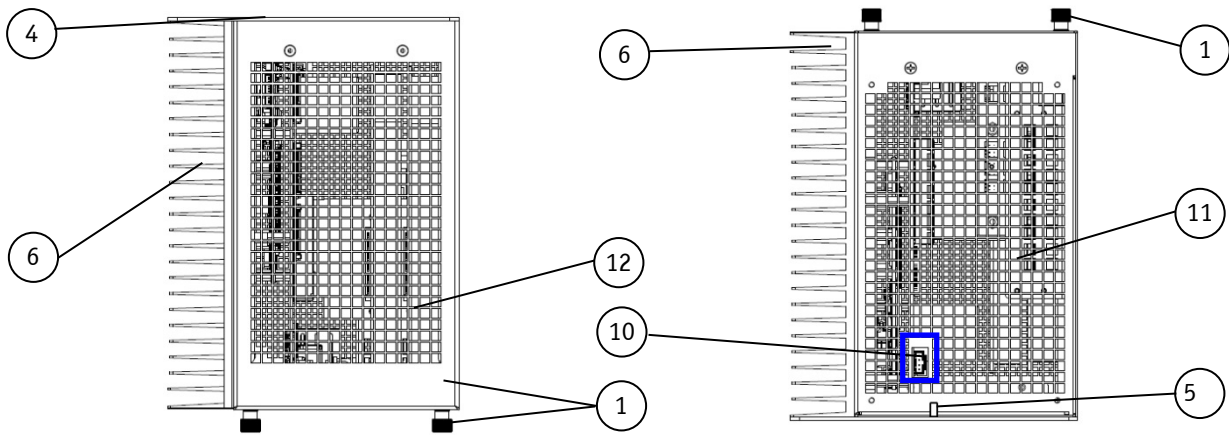

Fig. 30: Top side of the KBox C-101 system

Fig. 31: Bottom side of the KBox C-101 system

When powering on the KBox C-101, make sure that the air intake and exhaust openings are not obstructed. To provide sufficient heat dissipation for the cooling of the KBox C-101 system, never cover the cooling fins of the chassis. Do not place any objects onto the device.

7.7. Rear Side View

The KBox C-101 is designed for wall mounting, in vertical position inside of a control cabinet.



Please do not remove the red marked screws (see Fig. 32, pos. 2 and pos. 4).

Please observe the mounting instructions included in chapter 11 "Installation Instructions", and the outline dimensions in subsection 17.1 "Mechanical Specifications".

For the dimensions of the KBox C-101 versions with the optional fan expansion, refer to subsection 17.1.2 "Mechanical Specifications of the KBox C-101-2 with Fan Tray Option" and 17.1.4 "Mechanical Specifications of the KBox C-101-1 with Fan Tray Option".

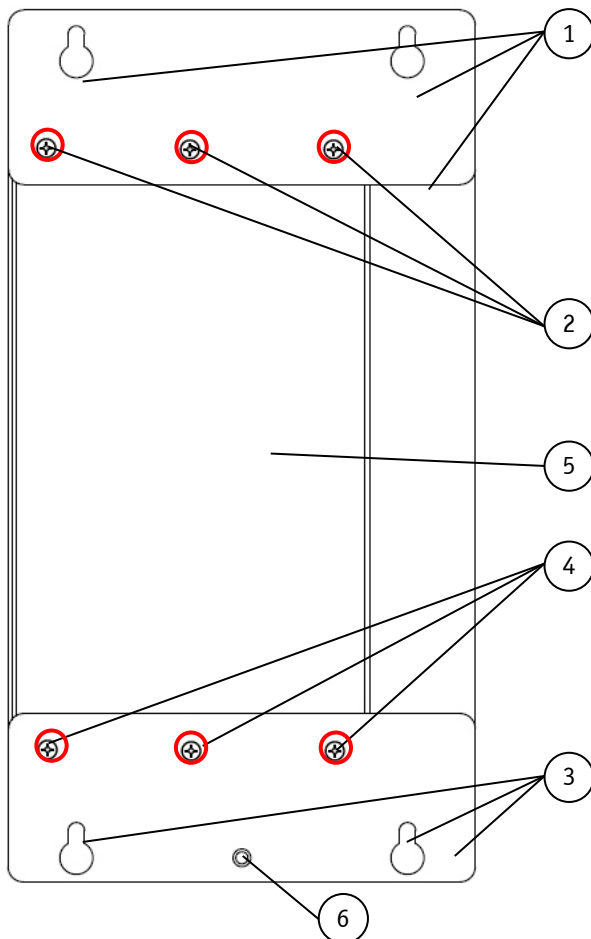

- 1 Key holes on the upper mounting bracket
- 2 Screws that secure the upper mounting bracket of the KBox C-101-2 and KBox C-101-1 (KBox C-101-0 has only 2 screws)
- 3 Key holes on the lower mounting bracket
- 4 Screws that secure the lower mounting bracket of the KBox C-101-2 and KBox C-101-1 (KBox C-101-0 has only 2 screws)
- 5 Chassis rear
- 6 Functional Earth stud

Fig. 32: Rear side of the KBox C-101-2 system

7.8. Functional Earth Stud

There is an M4 functional earth terminal on the lower mounting bracket of the KBox C-101 (Fig. 32, pos. 6). This terminal may be connected as required.



The KBox C-101 with the stud marked with a "Functional Earth" symbol (Fig. 32) has to be grounded to an appropriate "common earth" connection point.

8. System Extensions

Optional your KBox C-101 can be equipped by factory only, with following ports and additional components:

- ❑ Serial port RS232 or RS422 via an adapter module
- ❑ CAN port: via an adapter module
- ❑ DVI-D or DisplayPort: via corresponding adapter module
- ❑ Fan tray: an additional component connected to the KBox C-101-2 and KBox C-101-1

You have to order these components separately, in order to extend your KBox C-101 at the factory.
Example of system configuration, see below:

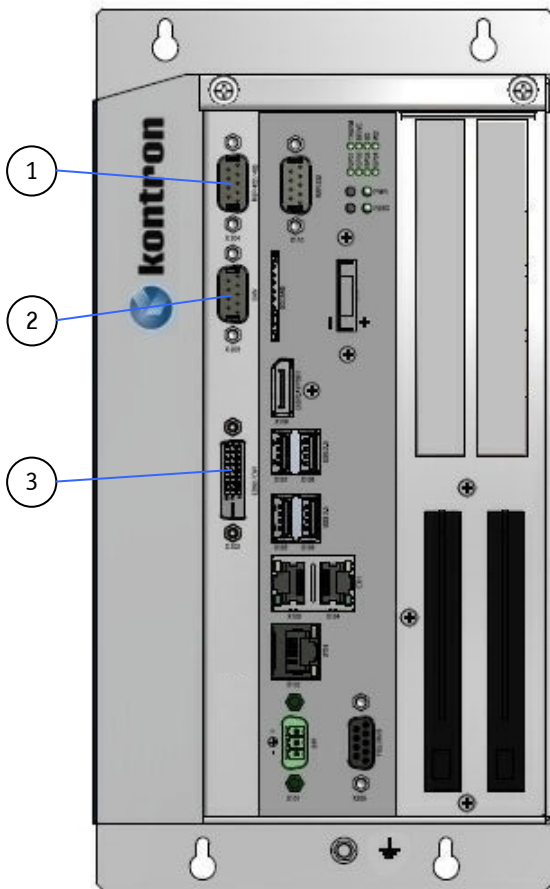

Fig. 33: KBox C-101-2 shown with optional interfaces and with removable drive bays

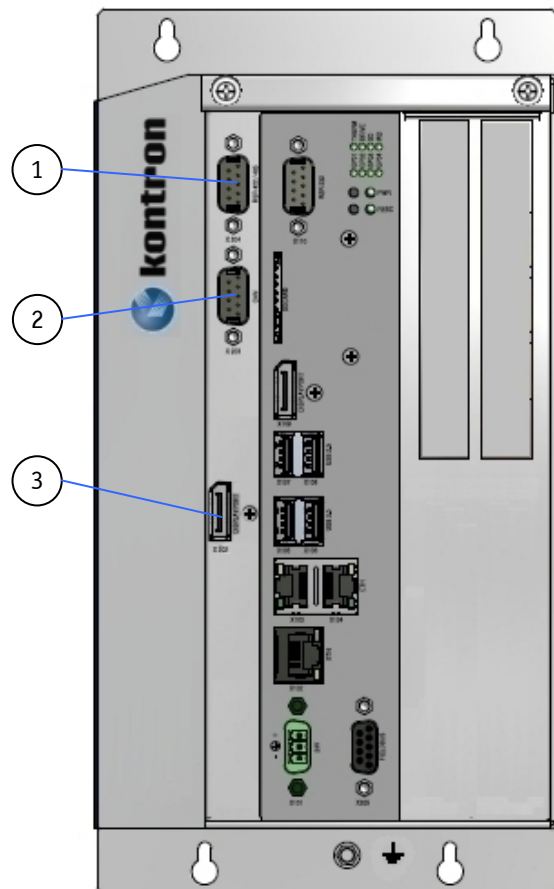

Fig. 34: KBox C-101-2 shown with optional interfaces and without removable drive bays

Legend for Fig. 33 and Fig. 34:

- 1 Serial port RS232/RS422
- 2 CAN port
- 3 DVI-D (Single Link) port or DisplayPort (DP 2)
(depending on the ordered option)

8.1. (X 204) - Serial Port RS232/RS422



This port can be only factory installed and configured.

When you order the KBox C-101 with this extended interface via RS232/422 adapter module, you have to specify in your ordering:

- the needed configuration of this port as RS232 or RS422 and
- for RS422 configuration: if the onboard termination resistor (120 Ω) should be enabled or disabled.

Your KBox C-101 can be extended, via an adapter module, with an additional serial interface RS232/RS422. This serial port (Fig. 33, Fig. 34, pos. 1) is available as 9-pin D-SUB connector (male), marked as "SERIAL" on the front side of the system. It must be factory configured as RS232 or RS422 corresponding to your ordered port configuration. The serial port will be configured via an on-board DIP switch (SW1) for RS232 or RS422 serial communication.

Your system order with RS422 port must also contain the specification about the termination resistor (120 Ω). If your application requires the termination resistor, it must be enabled at factory only. The corresponding DIP switch is not accessible for end user. For pin assignment refer to subsection 18.2.3.

8.2. (X 203) - CAN Port

Your KBox C-101 can be extended via an adapter module with a CAN port, that allows you CAN Bus communication. The optional CAN port (Fig. 33, Fig. 34, pos. 2) is implemented as a sub-D 9 pin connector (male). This port is galvanically isolated (500 V).

For pin assignment refer to section 18.2.4.



If a termination resistor (120 Ω) is required, you have to make a connection (bridge) between pin 1 and 2, respectively pin 7 and pin 8, in order to enable the onboard termination resistor (120 Ω).

8.3. (X 202) - DVI-D Interface Connector or DP 2 DisplayPort

Your KBox C-101 can optionally be extended with a DVI-D interface or a second DisplayPort (DP 2).



Only one of these two interfaces (DVI-D and DP 2) can be ordered as optional extension of your KBox C-101 system.

The DVI-D port (Single Link) (Fig. 33, pos. 3) marked "DVI" supports digital connections. Digital devices can be connected directly to this interface of the KBox C-101.

For pin assignment refer to subsection 18.2.1.

The DP 2 port is a DisplayPort compliant interface realised using a standard DisplayPort connector. An external (digital) display can be connected to the DisplayPort connector (DP 2) (Fig. 34, pos. 3).

For pin assignment refer to subsection 18.1.3.

8.4. Optional Versions with Fan Tray - KBox C-101-2/-1

By using a fan tray, the KBox C-101-2/-1 can be operated in a control cabinet with extended ambient temperature; refer to the specified values in section 17.2 "Environmental Specifications" and chapter 10 "Thermal Considerations".



All chapters of this manual are valid for the KBox C-101-2 and KBox C-101-1 with fan tray under consideration of the mechanical differences and the description in this section. Please refer also to subsection 17.1.2 "Mechanical Specifications of the KBox C-101-2 with Fan Tray Option", and subsection 17.1.4 "Mechanical Specifications of the KBox C-101-1 with Fan Tray Option".

The KBox C-101 with fan tray chassis extension is designed to provide a better airflow through the system chassis. The KBox C-101-2/-1 can be only factory equipped with the optional fan tray (Fig. 35). The fan tray slot is externally mounted to the bottom side of the KBox C-101-2/-1 chassis and comprises a fan tray (Fig. 35, pos. 1) with one fan as well as the air filter.

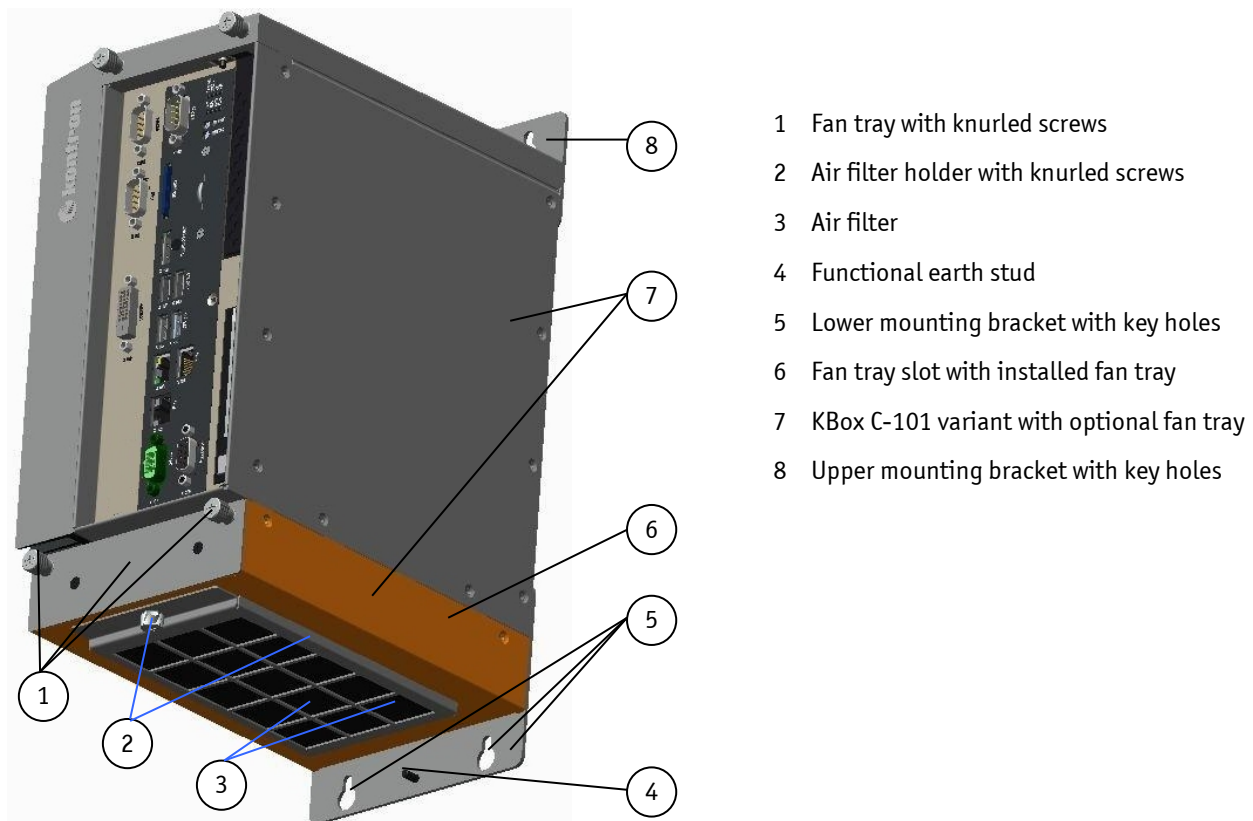

- 1 Fan tray with knurled screws
- 2 Air filter holder with knurled screws
- 3 Air filter
- 4 Functional earth stud
- 5 Lower mounting bracket with key holes
- 6 Fan tray slot with installed fan tray
- 7 KBox C-101 variant with optional fan tray
- 8 Upper mounting bracket with key holes

Fig. 35: KBox C-101-1 equipped with the optional fan tray

The fan is integrated in a user-friendly, replaceable fan tray (hot-swapping). The fan tray is designed to be inserted into the fan tray slot (Fig. 35, pos. 6) on the bottom side of the KBox C-101-2/-1. The fan tray simplifies the installation and removal of this component, even during operation.

The fan rotation speed is temperature controlled in dependence on the CPU temperature. Thus, a reliable air circulation for optimal active cooling of the KBox C-101-2/-1 is ensured.

The temperature conditions of the system (depending on the environmental temperature and the system load) are detected by the CPU temperature sensor.

In order to ensure a clean air circulation through the system, the fan tray slot provides an installed air filter (Fig. 35, pos. 3).

The air filter, which protects your system against dust and dirt, is washable and may be replaced during operation; refer to subsection 13.4 "Cleaning the Air Filter".

8.4.1. Fan Tray (only for KBox C-101-1 and KBox C-101-2)

**Important Instructions!**

The fan tray can be replaced during operation. This should only be carried-out by qualified personnel, aware of the associated dangers (see subsection 13.3 "Replacing the Fan Tray").

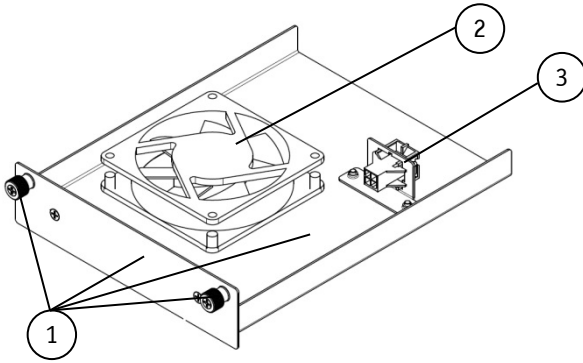

- 1 Fan tray with knurled screws
- 2 Fan (temperature-controlled)
- 3 Connector for fan power and control



*Fig. 36: Fan tray components of the KBox C-101-1/-2
(cable connections between fan and fan connector are included in this assembly)*

9. Accessing Internal Components

This chapter contains important information that you must read before accessing the internal components. You must follow these procedures properly when installing, removing or handling any system component.

It is recommended to expand your system with additional PCI/PCIe/PCIe mini cards before it is installed into an industrial control cabinet. Please consider following instructions when you install or remove expansion cards.

Before installing/removing an expansion card, please pay attention to the following information:

	<p>Please observe the “General Safety Instructions for IT-Equipment” provided with the system (refer also to chapter 4) and the installation instructions contained in this manual. The KBox C-101 system shall be mounted into a control cabinet.</p> <p>Only personnel with appropriate qualifications, trainings and authorization are permitted to install and work with the KBox C-101 system.</p> <p>The installation/removal of HDDs/SSDs and/or expansion cards may only be performed by a qualified person, according to the description in this manual.</p> <p>Before removing the cover of the device, make sure that the device is powered off and disconnected from the power supply.</p> <p>Before you upgrade the KBox C-101 with expansion cards, pay attention to the power specifications in chapter 17 “Technical Specifications” and make sure that the power consumption of the expansion cards does not exceed 15 W per card.</p>
	<p>Please follow the safety instructions for components that are sensitive to electrostatic discharge (ESD). Failure to observe this warning notice may result in damage to the device or/and internal components.</p>
	<p>Please pay attention to the manufacturer’s instructions before installing/removing an expansion card.</p>

9.1. Top Cover



The pictures in this section correspond to a KBox C-101-2 system.
The cover description can be applied to all system variants, under consideration of the different mechanical specifications of the KBox C-101; refer to section 17.1 "Mechanical Specifications".



When used as intended the KBox C-101 is to operate only in closed condition.
Only when the right side cover is fixed with the screws (Fig. 28, pos. 2) and top cover is properly installed and secured with the knurled screws (Fig. 58, pos. 2) on the front side, it is ensured that the user doesn't have access to the internal components of the KBox C-101 during operation.

The cover will be fixed to the chassis using the centering bracket at the rear side of the cover (Fig. 37, pos. 3) and the fixing bracket with captive knurled screws at the front side of the cover (Fig. 37, pos. 5).

Make sure the following requirements are met before inserting the cover:

- ❑ At the rear the centering bracket (Fig. 37, pos. 3) is inserted properly into the corresponding cover retaining bracket of the chassis (Fig. 42, pos. 13).
- ❑ At the front side the fixing bracket with captive knurled screws of the cover (Fig. 37, pos. 5), is matching properly over the cover retaining bracket on the front side (Fig. 42, pos. 1).

The fixing bracket with captive knurled screws (Fig. 37, pos. 5) secures the top cover on the front side (Fig. 58, pos. 2).

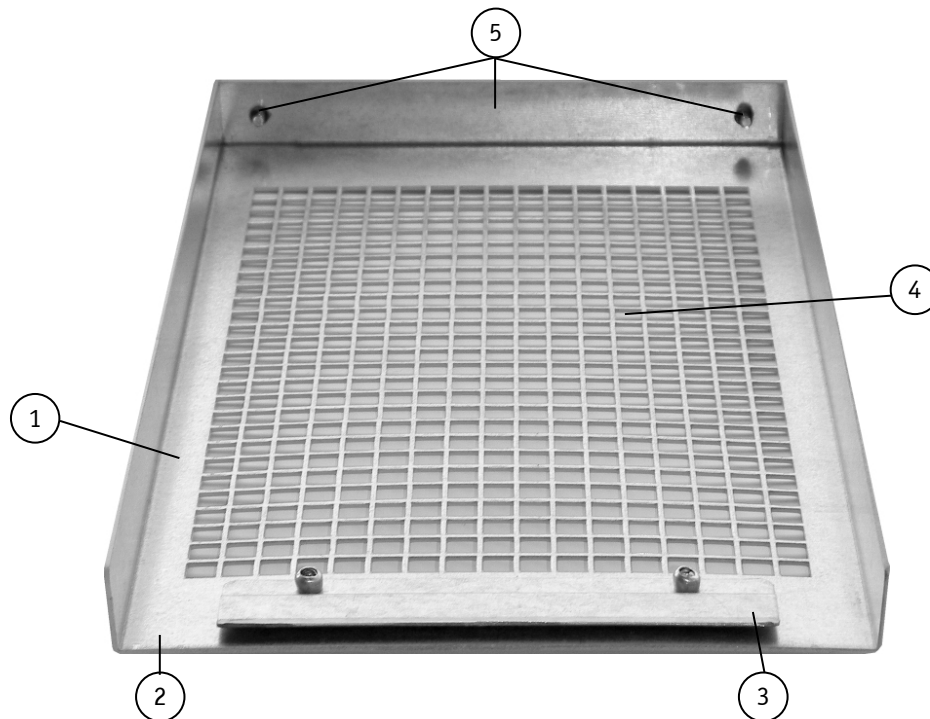

Fig. 37: Inside of the top cover with centering and fixing brackets

- | | |
|------------------------------|--|
| 1 Inside of the top cover | 3 Centering bracket (on the rear side) |
| 2 Rear part of the top cover | 4 Air exhaust openings |
| | 5 Fixing bracket with knurled screws on the front side |

9.2. Opening and Closing the KBox C-101



The pictures in this section correspond to a KBox C-101-2 system.

The "opening/closing" procedure description can be applied to all system variants, under consideration of the different mechanical specifications of the KBox C-101; refer to section 17.1 "Mechanical Specifications".

For opening/closing the KBox C-101, please perform the following steps:



The system must be powered off and disconnected from the mains power supply, before you attempt to open the KBox C-101. Ensure that you have a clean, flat and ESD-safe surface to work on. Also disconnect all peripheral devices from the KBox C-101. Please observe the instructions contained in chapter 11 "Installation Instructions".

1. Close all applications. Shut down the system properly and disconnect the connection to the power source. Disconnect all peripherals.
2. The KBox C-101 should lay on a flat, clean surface with the top side facing upwards.
3. Loosen the knurled screws, which secure the top cover on the front of the system (see Fig. 58/Fig. 60/Fig. 63, pos. 2 and Fig. 38).
4. Pull the cover out a little bit, as shown in Fig. 38, to release the cover centering and fixing brackets.



Fig. 38: This movement allows you to remove the centering and fixing bracket of the top cover (detail of the KBox C-101-2)

5. Lift the top cover up (on the front edge) and remove it (Fig. 39). Now you have access to the internal sockets (PCI/PCIe/Mini PCIe and mSATA) or to the corresponding cards/devices, in order to install or remove internal hardware components.



Fig. 39: Removing the cover (detail of the KBox C-101-2)

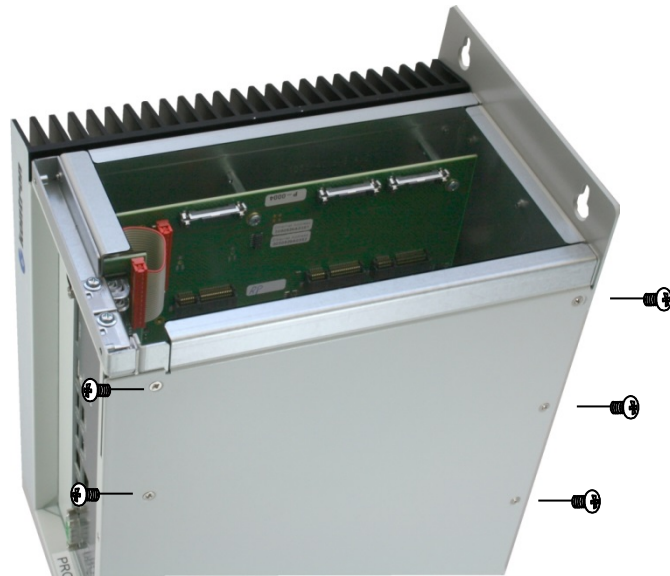

Fig. 40: KBox C-101-2 - removing the right side cover

6. For a better accessibility of the internal sockets (PCI/PCIe/Mini PCIe and mSATA SSD), you may also remove the right side cover of the KBox C-101 (Fig. 41). Loosen the externally accessible fastening screws (Fig. 28, pos. 2) that secure the right side cover (Fig. 40 and Fig. 28, pos. 3). Pull the right side cover out, to detach it from the sideways mounted bolts. Put the right side cover and the screws aside for later use.

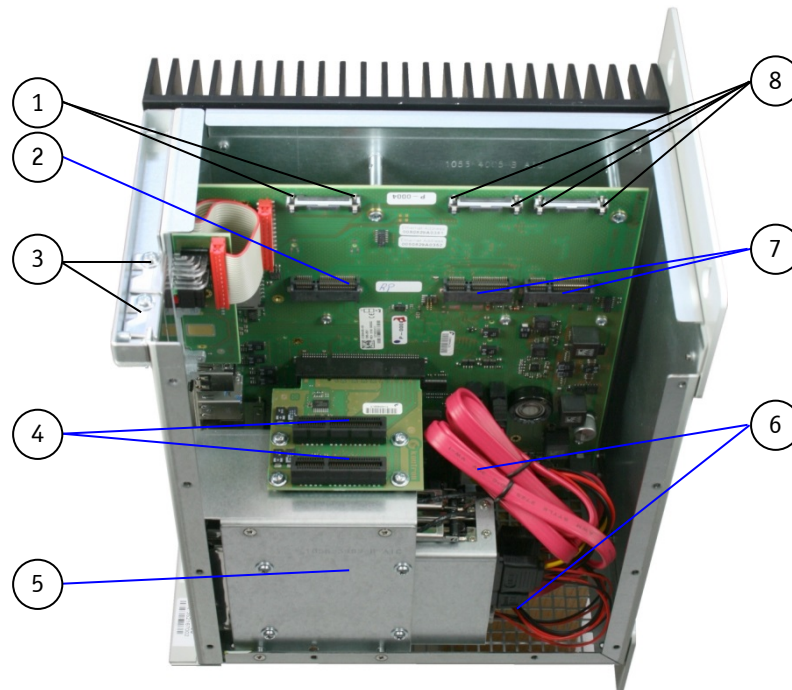

Fig. 41: KBox C-101-2 without top and right side cover (shown with a PCIe riser card)

- | | |
|---|--|
| 1 Fixing clips to secure the PCIe mini card | 5 Mounting frame for up to two removable 2.5" SATA HDD/SSD |
| 2 1x Mini PCIe socket for PCIe mini card | 6 SATA cable connections (power and data) |
| 3 Screws to fix the PCIe slot bracket or the I/O bracket of the PCIe card | 7 2x mSATA sockets |
| 4 Riser card with 2x PCIe x4 sockets | 8 Fixing clips to secure the 2x mSATA SSDs |

9.3. Internal View

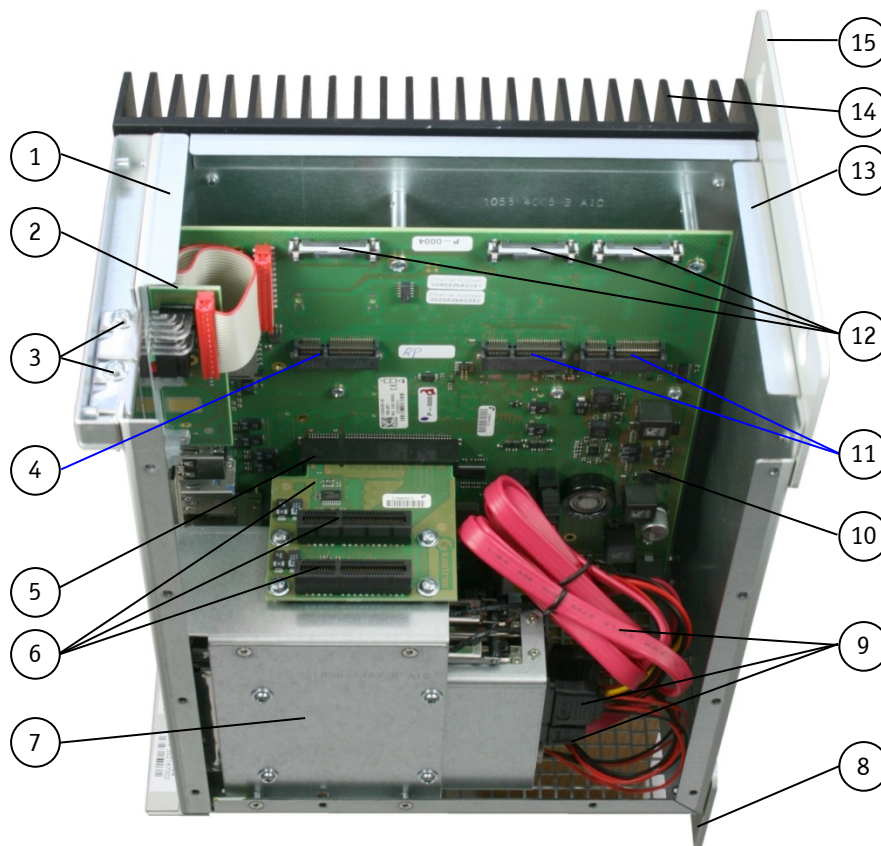

Fig. 42: KBox C-101-2 - internal view (shown with a PCIe riser card and removable HDD/SSD drive bay)

- | | |
|--|--|
| 1 Cover retaining bracket on the front side | 9 SATA cable connections (power and data) |
| 2 LED indicators circuit | 10 Baseboard |
| 3 Screws that secure the PCIe slot brackets | 11 2x mSATA sockets |
| 4 1x Mini PCIe socket for PCIe mini card (please observe the note below) | 12 Mechanical fixing assemblies for:
2x 2.5" mSATA SSD and 1x PCIe mini card (two fixing bolts for each mSATA SSD and PCIe mini card) (please observe the note below) |
| 5 PCI x8 socket of the baseboard | 13 Cover retaining bracket on the rear side |
| 6 Riser card with 2x PCIe x4 sockets | 14 Cooling fins |
| 7 Mounting frame for 2.5" drive bays of the removable HDDs/SSDs | 15 Upper mounting bracket with key holes |
| 8 Lower mounting bracket with key holes | |



The KBox C-101 provides two internal Mini PCIe sockets. You can see one of them in Fig. 42, pos. 4. The second Mini PCIe socket is on the bottom side of the baseboard and can be only at factory equipped with an expansion card.

9.3.1. Integrated COMe Module

Depending on the ordered system configuration, your KBox C-101 accommodates a baseboard with either a COMe-bHL6 i5-4402E or a COMe-bHL6 i7-4700EQ module.

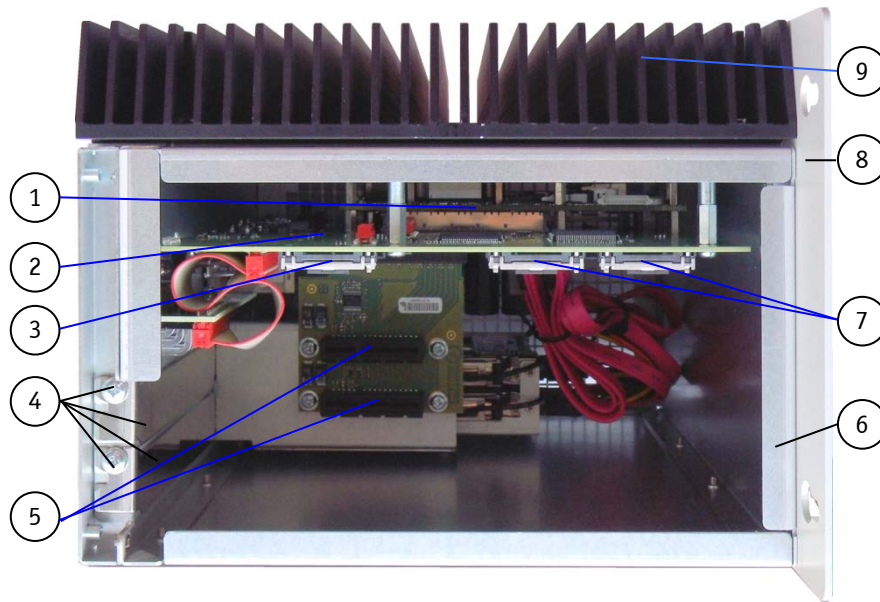

Fig. 43: KBox C-101-2 - internal view with COMExpress® module and with PCIe riser card

- | | |
|---|--|
| 1 COMExpress® module | 6 Cover retaining plate on the rear side |
| 2 Baseboard | 7 Mechanical fixing assemblies for 2x 2.5" mSATA SSD (two fixing clips for each mSATA SSD) |
| 3 Mechanical fixing assemblies for 1x PCIe mini card (two fixing clips for each PCIe mini card) | 8 Upper mounting bracket with key holes |
| 4 Screws that secure the PCIe slot brackets | 9 Cooling fins |
| 5 Riser card with 2x PCIe x4 sockets | |



Refer to the information and technical data included in the user manual of the installed COMe-BHL6 2002E, COMe-bHL6 i5-4402E-or a COMe-bHL6 i7-4700EQ module.

The user manual of the installed COMe module can be downloaded from our web page www.kontron.com . Search for the name of the installed module.

9.3.2. mSATA Socket

Depending on the system configuration ordered your KBox C-101 can be extended with up to two mSATA SSDs.

For installation/removing of the mSATA SSD refer to subsection 9.3.7 "Installing/Removing an mSATA SSD".

9.3.3. Expansion Socket for PCIe Mini Cards

Depending on the system configuration ordered, your KBox C-101 can be extended with up to two PCIe mini cards.



The KBox C-101 provides two internal Mini PCIe sockets for PCIe mini cards. One of them is internally accessible (Fig. 42, pos. 4). The second Mini PCIe socket is on the bottom side of the baseboard and can be only at factory equipped with an expansion card.

For installation/removing of the PCIe mini card (Fig. 42, pos. 4), please refer to subsection 9.3.6 "Installing/Removing the PCIe Mini Card".

9.3.4. Riser Cards Expansion Sockets for PCI/PCIe Cards

Depending on the system configuration ordered, your KBox C-101 can be extended with 1x PCI (32 bit) card and up to two PCIe x4/PCIe x1 cards (full-height, half-length form factor) via corresponding riser cards.

For installation/removing of PCI/PCIe cards into/from the corresponding socket

(Fig. 44, pos. 5 and pos. 6) / (Fig. 45, pos. 5 and pos. 8) and (Fig. 62, pos. 12).

Please refer to subsection 9.3.5 "Installing/Removing the PCI/PCIe Expansion Cards".



To expand your system with expansion cards, please observe the power consumption specified in the chapter 17 "Technical Specifications".

The power consumption of each expansion card does not exceed 15 W.



Please observe that:

KBox C-101-2: supports up to:

2x PCIe x4/PCIe x1 expansion cards **or**

1x PCIe x4/PCIe x1 and 1x PCI (32 bit) expansion cards.

For system configuration refer to Fig. 58, Fig. 59 and for expansion cards installation refer to subsection 9.3.5 "Installing/Removing the PCI/PCIe Expansion Cards".

KBox C-101-1: supports 1x PCIe x4/PCIe x1 expansion card.

For system configuration refer to Fig. 60, Fig. 61 and for expansion card installation refer to subsection 15.1.1 "PCIe Expansion Slot 1".

KBox C-101-0: can't be equipped with PCI/PCIe expansion cards.

Refer also to the area marked "C" in section 7.4.

9.3.5. Installing/Removing the PCI/PCIe Expansion Cards (for KBox C-101-2/-1 only)

The PCI/PCIe expansion cards can be installed into the slots on the front side of the system (Fig. 58/Fig. 60). The slots are marked with “PCIe 1” and “PCIe 2”. It is recommended to expand your KBox C-101 with PCI/PCIe cards before it is installed on a wall into a control cabinet.

1. Close all applications; shut down the system properly and disconnect the connection to the power source. Disconnect all peripherals.
2. To have access to the PCI/PCIe x4 sockets you have to open the KBox C-101-2/-1 as described in section 9.2 “Opening and Closing the KBox C-101” (step 1-6).
3. To remove/install an expansion card, you have to remove the corresponding card/slot bracket (refer to Fig. 58/Fig. 60 and Fig. 44/Fig. 45). Loosen the corresponding fastening screw on the internal side, which secures the slot/card bracket and remove it. Retain the screw for later use (refer to Fig. 44/Fig. 45, pos. 2).

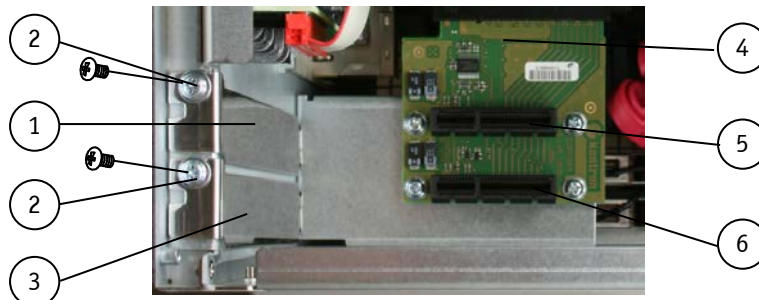

Fig. 44: Detail of the KBox C-101-2 with PCIe riser card with 2x PCIe x4 sockets

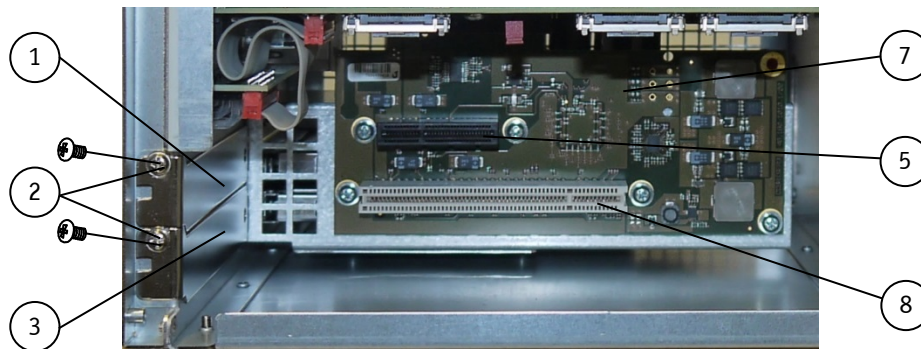

Fig. 45: Detail of the KBox C-101-2 with PCI-PCIe riser card with 1x PCI (32 bit) and 1x PCIe x4 sockets

Legend for Fig. 44 and Fig. 45:

- | | |
|--|---|
| 1 Slot bracket for the for the PCIe 1 expansion slot | 5 Free PCIe x4 socket (for PCIe 1 slot) |
| 2 Screws to secure the expansion slot/cards brackets | 6 Free PCIe x4 socket (for PCIe 2 slot) |
| 3 Slot bracket for the for the PCIe 2 expansion slot | 7 Riser card with 1x PCI and 1x PCIe x4 expansion sockets |
| 4 Riser card with 2x PCIe x4 expansion sockets | 8 Free 1x PCI (32 bit) (for PCIe 2 slot) |

4. Insert/remove the expansion card into/from the corresponding PCI/PCIe x4 socket of the corresponding riser card (Fig. 44, pos. 5, pos. 6 or Fig. 45, pos. 5, pos. 8).
5. If you have removed an expansion card, re-insert the slot bracket.
6. Secure the card or slot bracket to the chassis with the retained fastening screw.
7. In order to close the KBox C-101-2, proceed in reverse order (step 6 to 1 in section 9.2).

9.3.6. Installing/Removing the PCIe Mini Card

To install a PCIe mini card please proceed according to the steps described:

1. Close all applications; shut down the system properly and disconnect the connection to the power source. Disconnect all peripherals.
2. Open the device as described in section 9.2 "Opening and Closing the KBox C-101" (step 1-6).
3. Locate the PCIe mini card socket and the corresponding fixing clips (Fig. 41, pos. 1).
4. Insert the PCIe mini card into the socket (Fig. 41, pos. 2) at an angle of approx. 45° and push it down until the fixing holes of the card are aligned with the fixing clips.
5. Press the PCIe mini card down (on the side with the fixing holes) until the card snaps in the fixing clips.
6. In order to close the KBox C-101, proceed in reverse order (step 6 to 1 of section 9.2).

To remove a PCIe mini card please proceed according to the steps described:

1. Close all applications; shut down the system properly and disconnect the connection to the power source. Disconnect all peripherals.
2. Open the device as described in subsection 9.2 "Opening and Closing the KBox C-101" (step 1-6).
3. Locate the PCIe mini card installed into your system.
4. Slide outwards the fixing clips in order to release the PCIe mini card. It will spring up at an angle of approx. 45° on the fixing clips side.
5. Gently pull the PCIe mini card out.
6. In order to close the KBox C-101, proceed in reverse order (step 6 to 1 of section 9.2).

9.3.7. Installing/Removing an mSATA SSD

To install an mSATA SSD please proceed according to the steps described:

1. Close all applications; shut down the system properly and disconnect the connection to the power source. Disconnect all peripherals.
2. Open the device as described in subsection 9.2 "Opening and Closing the KBox C-101" (step 1-6).
3. Locate the mSATA sockets and the corresponding fixing clips. (Fig. 41 and 8).
4. Insert the mSATA SSD card into the corresponding socket (Fig. 41, pos. 7) at an angle of approx. 45° and push it down until the fixing holes of the card are aligned with the fixing clips.
5. Press the mSATA SSD down (on the side with the fixing holes) until the mSATA SSD snaps in the fixing clips.
6. In order to close the KBox C-101, proceed in reverse order (step 6 to 1 of section 9.2).

To remove an mSATA SSD please proceed according to the steps described:

1. Close all applications; shut down the system properly and disconnect the connection to the power source. Disconnect all peripherals.
2. Open the device as described in subsection 9.2 "Opening and Closing the KBox C-101" (step 1-6).
3. Locate the mSATA SSD card installed into your system.
4. Slide outwards the fixing clips in order to release the mSATA SSD. It will spring up at an angle of approx. 45° on the fixing clips side.
5. Gently pull the mSATA SSD card out.
6. In order to close the KBox C-101, proceed in reverse order (step 6 to 1 of section 9.2).



Preventive Maintenance for SSD drive:

Because of the limited predetermined lifespan of SSDs, we recommend to check the condition of your installed SSD drives via S.M.A.R.T. regularly.

Pay attention to the manufacturer specifications for lifespan.

10. Thermal Considerations

10.1. Available Processors

Please refer to chapter 17 “Technical Specifications”.



The list of processors is not complete and may be extended over the product lifetime.

10.2. Convection Cooling

The KBox C-101 is designed for convection cooling within the specified ambient air temperature ranges. Therefore it is imperative that air flow to and from the unit is guaranteed.

In addition, implementers must empirically verify the cooling concept for the KBox C-101 including optionally installed devices prior implementing the unit in the intended application.

10.3. Active Cooling via the optional Fan Tray

For applications where convection cooling is not sufficient, there is the possibility to use the optional fan tray (externally mounted to the KBox C-101-2 and KBox C-101-1). The optional fan tray extension allows to operate the system at higher ambient temperature conditions and provides a higher air flow through the chassis providing a better cooling of the system internal components.

10.4. Minimum System Clearance

To provide a maximum of airflow through and around the box, minimum distances to surrounding parts must be observed (please refer to subsection 11.1 “Control Cabinet Mounting” and Fig. 46 to Fig. 50).

10.5. Maximum Temperatures

As the Intel® processors provide only certain settings for maximal power consumption some typically are used for the following table. This table can be seen as a guideline.

Processor Power Consumption	KBox C-101 without Fan Tray		KBox C-101 with Fan Tray	
	Max. ambient Temperature [°C]	Approx. System internal Temp. Rise [°C]	Max. ambient Temperature [°C]	Approx. System internal Temp. Rise [°C]
25 W	65	5	70	2
37 W	59	5	65	2
47 W	50	5	55	2



The maximum system ambient temperature depends mostly on the power consumption of the processor and the chipset.

For the temperature evaluation a specialized tool from Intel® was used to set the processor to a defined workload. Depending on the power consumption one or more cores were set to 75 % workload. This includes the graphics core. The tool also handles the usage of the "Turbo Mode" of certain processor types.



The processor utilization depends highly on the software used. Software using multicore feature will run on several cores whereas standard software will only utilise one core. In this case the processor will use the "Turbo Mode" to increase the clock for the core with the highest workload, as long as the temperature is within limits.

10.6. Third Party Components

When the KBox C-101 is extended and configured with third party components like PCIe extension cards and hard drives (HDD or SSD), it has to be taken into account that the air temperature inside the system is higher than the ambient temperature. An approximately internal temperature rise is given.

10.7. Processor Thermal Monitoring

The processor used with the KBox C-101 system provides internal thermal monitoring. Every core of the processor comprises a temperature sensor.

To allow an optimal operation and long-term reliability, the processor must operate in the specified temperature range. To avoid overheating the processor performs an automatic thermal management, which intends to keep the processor temperature below the highest value of the temperature range. This behavior is a CPU standard feature.

10.8. Processor Thermal Trip Feature

The Processor Thermal Trip feature protects the processor from catastrophic overheating. The Thermal Trip Tensor threshold is set well above the normal operating temperature to ensure that there are no false trips. The processor will stop all executions when the junction temperature exceeds approximately 125 °C. This event will be indicated by the red blinking "Thermal" LED on the front panel. This behavior cannot be altered. Once activated, the event remains latched until power is cycled.

11. Installation Instructions

The KBox C-101 comes with attached wall mount brackets. The available mounting key holes (Fig. 32, pos. 1 and pos. 3) of the wall mounting brackets allow the unit attaching to a wall of a fire resistant enclosure.

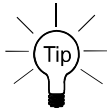

Expansion card installation should be performed before installing the KBox C-101 into the control cabinet.



Whenever possible, unpack or pack this product only at EOS/ESD safe work stations. Where a safe work station is not guaranteed, it is important for the user to be electrically discharged before touching the product with his/her hands or tools. This is most easily done by touching a metal part of the system chassis.

Do not handle this product out of its protective enclosure while it is not used for operational purposes unless it is otherwise protected.

Prior any installation work ensure that there are no live wires on the installation site

Do not handle the device if there is any damage visible.

Do not operate the KBox C-101 with foreign objects inside the chassis.

Further do not insert any retrieval device into the device while it is connected to power.

Kontron rejects all liability for any and all damages resulting from operation of the unit with foreign objects inside the chassis.

The KBox C-101 has to be installed and operated only by trained and qualified personnel.

The KBox C-101 system is designed for usage within control cabinets only.

Only personnel with appropriate qualifications, trainings and authorization are permitted to install and work with the Kontron KBox C-101.

This device shall only be installed in or connected to systems that fulfill all necessary technical and specific environmental requirements.

The KBox C-101 system is designed to be operated in vertical position with attached mounting brackets as shown in Fig. 8 and Fig. 9. It is not allowed to install the KBox C-101 as a stand-alone (desktop) device.

Do not remove the wall mounting brackets.

The unit must be placed such that there is sufficient space in front of it for connecting the cables to the I/O interface connectors and for operating the power button.

Leave sufficient free space around the unit to prevent the device from possibly overheating!

To ensure proper operation, we recommended free space as specified below:

- above and below: 100 mm (3.937")
- left and right: 50 mm (1.96")

See also Fig. 46 to Fig. 50 section 17.1 "Mechanical Specifications".

It must be observed that all ventilation openings are not covered/obstructed by objects.

The KBox C-101 must be firmly attached to a clean flat and solid mounting surface. Use proper fastening materials suitable for the mounting surface. Ensure that the mounting surface type and the used mounting solution safely support the load of the KBox C-101 and the attached components.

Please follow the local/national regulations for grounding.

The voltage feeds must not be overloaded. Adjust the cabling and the overcurrent protection to correspond with the electrical figures indicated on the type label.

The type label is located on the right side of the system.

It is recommended that the last cable attached to the system should be the power cable! Refer to section 11.2 "DC Power Plug Terminal" and chapter 12 "Starting Up".

11.1. Control Cabinet Mounting



Please observe the “General Safety Instructions for IT Equipment” (included) and the installation instructions (refer to chapters 4 and 11).

Your KBox C-101 is supplied with assembled mounting brackets. The key holes of the upper and lower mounting brackets (Fig. 32, pos. 1 and pos. 3) allow you to mount the KBox C-101 to a mounting side of the control cabinet in vertical position. This is the only permitted operating position.



For a sufficient air circulation around the device, we recommend not to place (mount) or operate any other devices within the “keep out area”. The clearances of “50mm” and “100mm” around the KBox C-101 must be observed; refer to the marked areas in Fig. 46 to Fig. 50.

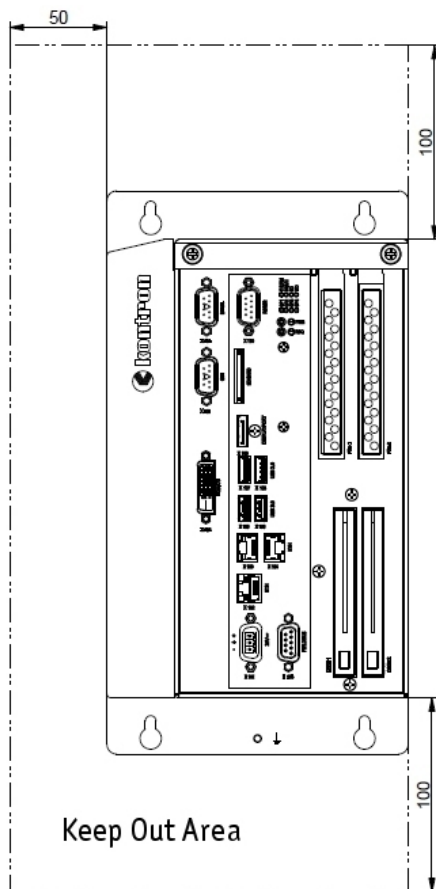

Fig. 46: Keep out area for mounting around KBox C-101-2
(front side view without fan tray)

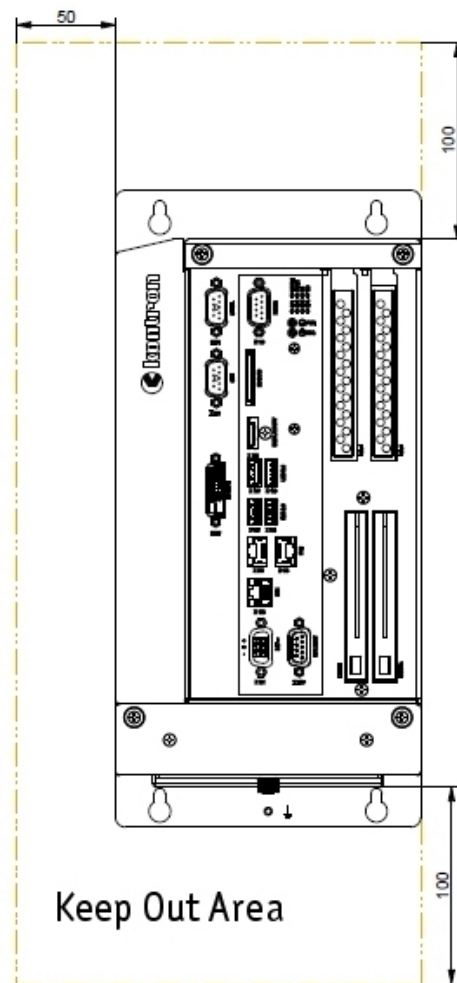

Fig. 47: Keep out area for mounting around KBox C-101-2
(front side view with optional fan tray)

Prepare the mounting surface with four screws and if necessary anchors corresponding to the mounting surface type (fire-resistant material). Please refer to the information for mounting to section 17.1, “Mechanical Specifications of the KBox C-101”, and subsections 17.1.1 / 17.1.2 / 17.1.3 / 17.1.4 and 17.1.5, or refer to the drawings for KBox C-101 on our web site. The drawings can be downloaded from our web site www.kontron.com by selecting the product.

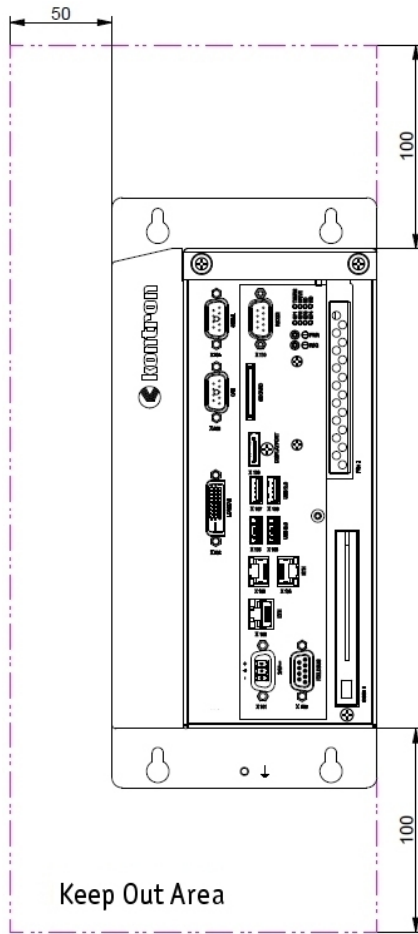

Fig. 48: Keep out area for mounting around KBox C-101-1 (front side view without fan tray)

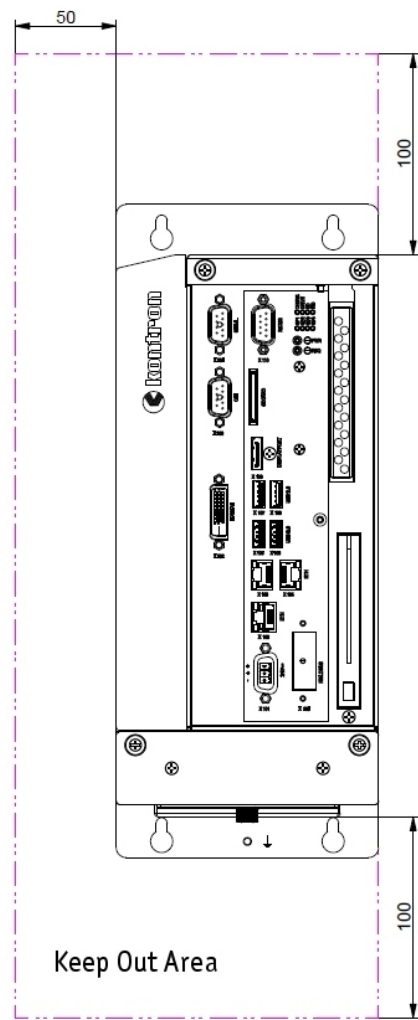

Fig. 49: Keep out area for mounting around KBox C-101-1 (front side view with optional fan tray)

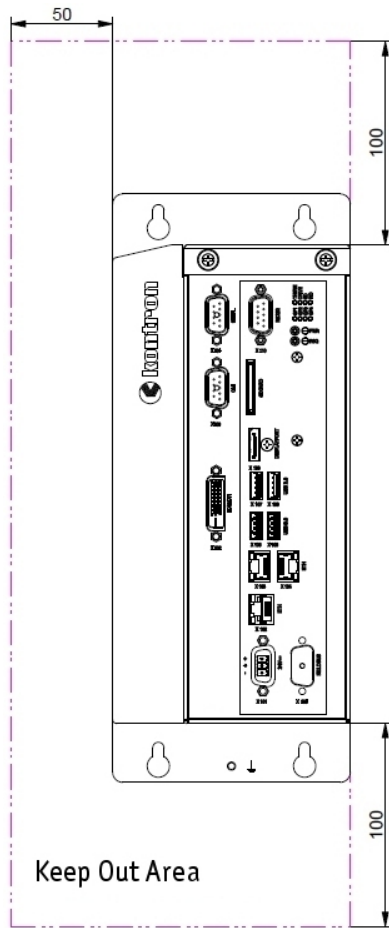

Fig. 50: Keep out area for mounting around KBox C-101-0

11.2. DC Power Plug Terminal

The KBox C-101 is connected by a Phoenix connector to a DC power source via a DC power supply wiring (only the Phoenix power plug terminal is included).

The KBox C-101 is delivered with a DC power plug terminal (3-pin Phoenix connector). For DC connection, prepare the connecting wires using the supplied Phoenix plug terminal: PSC 1,5/ 3-F.

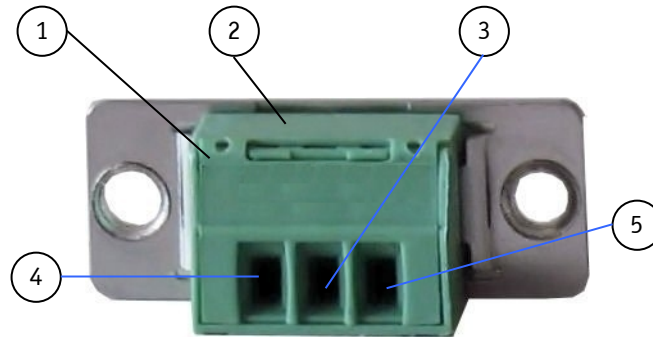

Fig. 51: Phoenix power plug terminal

- | | |
|--|--|
| 1 3-pin Phoenix plug terminal | 4 Location for inserting the "24 V" wire |
| 2 Cover over the slotted pan head screws | 5 Location for inserting the "0 V" wire |
| 3 Location for inserting the functional earth wire | |

11.2.1. Cabling

For the pin assignment Phoenix power plug terminal refer to subsection 7.4.1 "X 101 - Power Input Connector".

1. Cut the required length three isolated wires (1 mm²) AWG18 and strip each end 5 –7 mm.
2. Twist the striped wire-ends and provide them with ferrules.
3. Open the cover (Fig. 51, pos. 2) to have access to the slotted pan head screws.
4. Loosen the slotted pan head screws of the DC plug terminal far enough so that you can insert the end of the prepared wires.
5. Insert the wires into the corresponding clamp of the Phoenix plug terminal. Make sure that you have the right polarity of the connection [refer to Fig. 51, Fig. 18 or subsection 18.1.1, "(X 101) Power Input Connector"].
6. Fasten the screws to secure the wires into the clamps of the plug terminal.
7. Close the cover (Fig. 51, pos. 2).

12. Starting Up



The KBox C-101 must be operated only with the nominal voltage of 24 V DC of type SELV. For details refer to chapter 17 "Technical Specifications".

12.1. Connecting to DC Main Power Supply

The DC input connector (Fig. 58 and Fig. 18 marked X 101) is located on the front side of the KBox C-101. The KBox C-101 will be connected to a DC main power supply via the supplied Phoenix power plug terminal (see Fig. 51) and corresponding power wires (prepared as described in subsection 11.2.1 "Cabling").

	<p>Before using your system, become familiar with the system components and check that everything is properly connected. Following a proper cabling procedure will prevent a false power-on condition, which could result in unit operational failure.</p> <p>When you install/disconnect the unit, the functional earth connection must always be made first and disconnected last.</p> <p>Also, it is recommended that the last connections attached to the system should be the power wires!</p>
	<p>The KBox C-101 must be connected DC mains power supply complying with the SELV (Safety Extra Low Voltage) requirements of EN 60950-1 standard. It must be observed that wiring and short-circuit/overcurrent protection is performed according to the applicable standards, regulations and respect to the electrical specification of the KBox C-101.</p> <p>Even when the system is turned off via the power button (Fig. 58/Fig. 60/Fig. 63 and Fig. 21, marked PWR) parts of the system are still energized.</p> <p>The disconnecting device (fuse/circuit breaker) rating must be in accordance with the wire cross-section and the rated current of the KBox C-101.</p>



The wires used for power connections must be clearly marked (+/-/functional earth) to ensure that they will be properly connected to the DC IN connector of the KBox C-101 and to the main power source, corresponding to signals marked; refer to Fig. 18 and Fig. 51.

In addition, the cables must have some form of support so as to minimize the strain on the unit's connectors.

To connect the KBox C-101 to a corresponding DC main power supply, please perform the following steps:

1. Ensure that the DC power source is switched off via a disconnecting device (circuit breaker), in order to ensure that no power is flowing from the external DC power source during the connection procedure.
2. Connect at first the wire for "Functional Earth stud" (Fig. 32, pos. 6) to an appropriate "common earth" connection point.
3. Connect the Phoenix power terminal prepared as described in subsection 11.2.1 "Cabling" to the DC input connector (Fig. 58/Fig. 60/Fig. 63 and Fig. 18 marked X 101) of the KBox C-101. The DC input connector is located on the front side and is marked "24 VDC".
4. Connect the other ends of the DC power wires to the connections of the DC main power supply. Pay attention to the polarity of the connections.
5. Switch on the disconnecting device (circuit breaker) in order to apply voltage to the terminals of the power wires.

12.2. Power OFF/ON Procedure

As the KBox C-101 is equipped with an internal hold-up buffer, it can't be powered off/on immediately. The buffer time depends on the power consumption and load on the KBox C-101 processor and peripherals. Therefore the following procedure must be observed.

1. Close your applications and perform an orderly shutdown (graceful shutdown).
2. Remove power from the system.
3. Wait until the green power LED (Fig. 21, pos. 2) stops blinking.
4. Wait at least 3 seconds.
5. Reapply power.

Refer also to subsection 7.4.8 "POWER Button and PWR LED".



Caution!

Do not disconnect the power from your system while it is powered up!
Performing a forced shutdown can lead to loss of data or other undesirable effects!

12.3. Operating System and Hardware Component Drivers

Your system can be supplied optionally with a pre-installed operating system.

If you have ordered your KBox C-101 with a pre-installed operating system, all drivers are installed in accordance with the system configuration ordered (optional hardware components). Your system is fully operational when you power it on for the first time. Please pay attention to the following note.



Important information on the use of the pre-installed "WINDOWS 7 ULTIMATE FOR EMBEDDED SYSTEMS" or "WINDOWS 7 PROFESSIONAL FOR EMBEDDED SYSTEMS" or "WINDOWS EMBEDDED 8.1 INDUSTRY PRO " or "WINDOWS EMBEDDED 8.1 INDUSTRY PRO RETAIL" operating systems:

The terms and conditions for the use of the pre-installed operating systems are specified in the document "MICROSOFT SOFTWARE LICENSE TERMS".

You can download this document from our web site www.kontron.com by selecting Product/ Downloads tab/Windows.

If you have ordered The KBox C-101 without a pre-installed operating system, you will need to install the operating system and the appropriate drivers for the system configuration you have ordered (optional hardware components) yourself.



You can download the relevant drivers for the installed hardware from our web site at www.kontron.com by selecting the product.

Pay attention to the manufacturer specifications of the operating system and the integrated hardware components.

13. Maintenance and Cleaning

Equipment from Kontron requires only minimum servicing and maintenance for proper operation.

- ❑ For light soiling, clean the KBox C-101 with a dry cloth.
Carefully remove dust from the surface of the cooling fins of the chassis using a clean, soft brush.
- ❑ Stubborn dirt should be removed using a mild detergent and a soft cloth.



Do not use steel wool, metallic threads or solvents like abrasives, alcohol, acetone or benzene for cleaning the KBox C-101.

13.1. Replacing the Lithium Battery

If your KBox C-101 is equipped with the optional lithium battery (externally accessible), and you have to replace it, please proceed as follows:

1. Unscrew the screw (Fig. 4, pos. 2), that secure the battery protective cover (Fig. 4, pos. 1) to the chassis.
2. Remove the screw and the cover to have access to the battery (Fig. 5, pos.3). Retain them for later use.
3. Remove the lithium battery from the holder by pulling it outwards.
4. Place a new lithium battery in the battery holder.
5. Pay attention to the polarity of the battery (as shown in Fig. 52).
6. The lithium battery must only be replaced with the same type of battery or with a type of battery recommended by Kontron Europe.
7. Replace the protective cover over the battery and secure the cover with the retained screw.



Please note that only the Philips countersunk head screw M2.5x10 DIN965 (removed in step 2) may be used to secure the protective cover. Longer screws than M2.5x14 could damage internal components of the system.

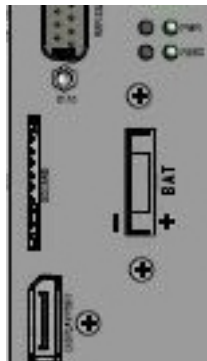

Fig. 52: Lithium battery polarity

	<p>Caution</p> <p>Danger of explosion when replacing with wrong type of battery. Replace only with the same or equivalent type recommended by the manufacturer. The lithium battery type must be UL recognised.</p>
	<p>Do not dispose of lithium batteries in general trash collection. Dispose of the battery according to the local regulations dealing with the disposal of these special materials, (e.g. to the collecting points for dispose of batteries).</p>

13.2. Preventive Maintenance for SSD Drives

This section applies to all mSATA and SSD devices installed into the KBox C-101 system.



Because of the limited predetermined lifespan of the mSATA/SATA SSD devices, we recommend to check the condition of your installed SSD drives via S.M.A.R.T. regularly.

Pay attention to the manufacturer specifications for lifespan.

For replacing of these devices refer to sections: 7.4.13 and 9.3.7.

13.3. Replacing the Fan Tray



The operation of the KBox C-101 versions with fan tray extension is permitted only with a functional fan tray!

Defective components may only be replaced by Kontron original spare parts:

- Part number of the fan tray: 1055-4009 for KBox C-101-2
- Part number of the fan tray: 1056-7503 for KBox C-101-1

The fan tray can be replaced during operation. This should only be carried-out by qualified personnel aware of the associated dangers.

The fan will not stop immediately when the fan tray is removed during operation. Pull out the fan tray only a few centimeters and wait until the fan comes to stop.

To replace fan tray, proceed as follows:

1. Ensure to have access to the bottom side of the KBox C-101-2/-1. The fan tray (Fig. 53, pos. 1 and Fig. 54, pos. 2) may be replaced without removing the air filter holder (Fig. 53, pos. 4).
2. Loosen the two knurled screws (Fig. 53, pos. 2) of the fan tray.
3. Pull the fan tray (Fig. 54, pos. 2) out of the fan tray slot (Fig. 54, pos. 3) in order to disconnect the connector for fan power and control (Fig. 36, pos. 3) from the internal fan control socket (Fig. 54, pos. 10).
4. Pull the fan tray completely out of the fan tray slot (Fig. 54, pos. 3).
5. Replace the defective fan tray with a new one.
6. Insert the functional fan tray (Fig. 54, pos. 2) into the fan tray slot (Fig. 54, pos. 3).
7. Secure the fan tray by fastening the knurled screws (Fig. 53, pos. 2). By fastening of the knurled screws the proper insertion of the fan tray into the internal socket (Fig. 54, pos. 10) is ensured.

13.4. Cleaning the Air Filter

The air filter is inserted in the holder (Fig. 35, pos. 2) at the bottom side of the fan tray slot (Fig. 35, pos. 6). The soiling of the air filter (Fig. 35, pos. 3) is caused by the pollution of the operating environment. A heavily soiled air filter can cause excessive heating of the device. For this reason we recommend to clean the air filter as often as necessary. The air filter can be changed during operation of the system.

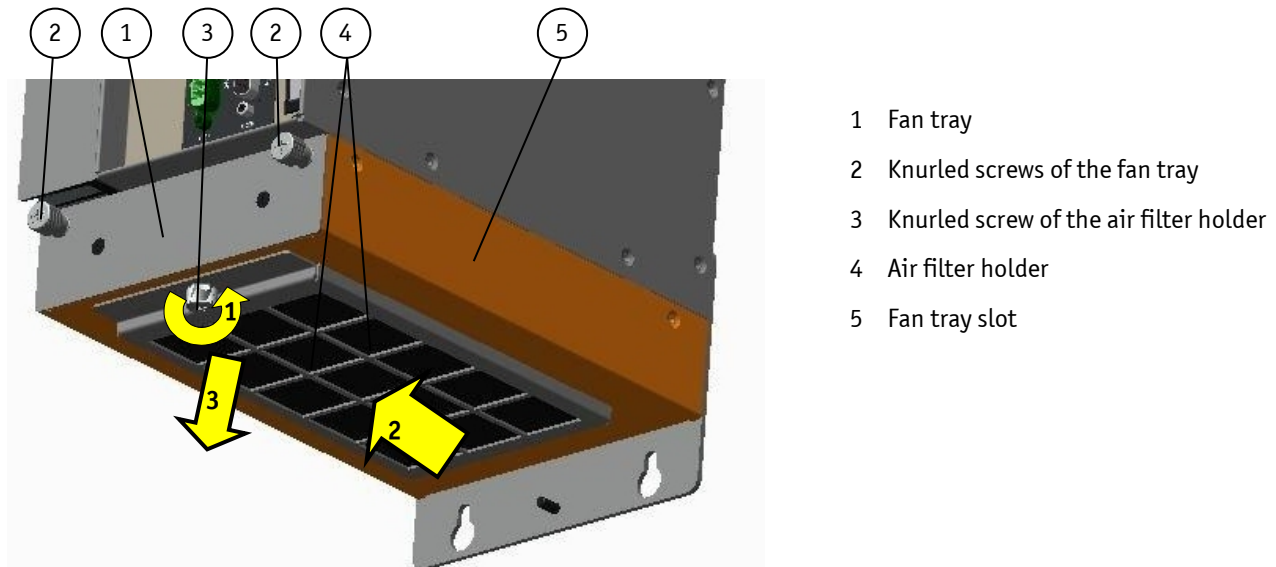

Fig. 53: Fan tray extension (detail: shown as KBox C-101-1)

To replace the air filter, proceed as follows:

1. Ensure to have access to the bottom side of the KBox C-101-2/-1. The air filter may be replaced without removing the fan tray (Fig. 53, pos. 1).
2. Loosen the knurled screw (Fig. 53, pos. 3) that secures the air filter holder (Fig. 53, pos. 4) to the fan tray slot (Fig. 53, pos. 5); refer to step 1 in Fig. 53.
3. Pull the air filter holder out of the positioning holes, (Fig. 54, pos. 9) into the marked direction (see Fig. 53) and pull it down. Put the air filter holder aside for later reassembly; refer to step 2 and 3 in Fig. 53.
4. Remove the soiled air filter (Fig. 53, pos. 3 and Fig. 54, pos. 6).
5. Clean the air filter as follows:
 - Rinse in water (up to approx. 40°C; possibly with the addition of a standard mild detergent).
 - It is possible to clean the air filter with compressed air.
 - For dirt that contains grease/oil, the air filter should be rinsed with warm water with the addition of a degreaser. Air filter should not be cleaned with powerful water jets or wrung out.
6. After cleaning and drying the air filter, place it in the air filter holder.
7. Reattach the air filter holder to the bottom side of the fan tray slot by inserting the positioning latches (Fig. 54, pos. 8) into the positioning holes (Fig. 54, pos. 9).
8. Secure the air filter holder by tightening the knurled screw to the tapped hole (Fig. 54, pos. 4) of the fan tray slot (Fig. 53, pos. 5 or Fig. 54, pos. 3).



Defective components may only be replaced by Kontron original spare parts.

- Air filter: part number: 1055-4670 (for KBox C-101-2)
- Air filter: part number: 1056-7507 (for KBox C-101-1)



The pictures in this section correspond to a KBox C-101-2 system. The description of the procedure for cleaning the air filter can be applied to both KBox C-101-2/-1 variants, under consideration of the different mechanical specifications.

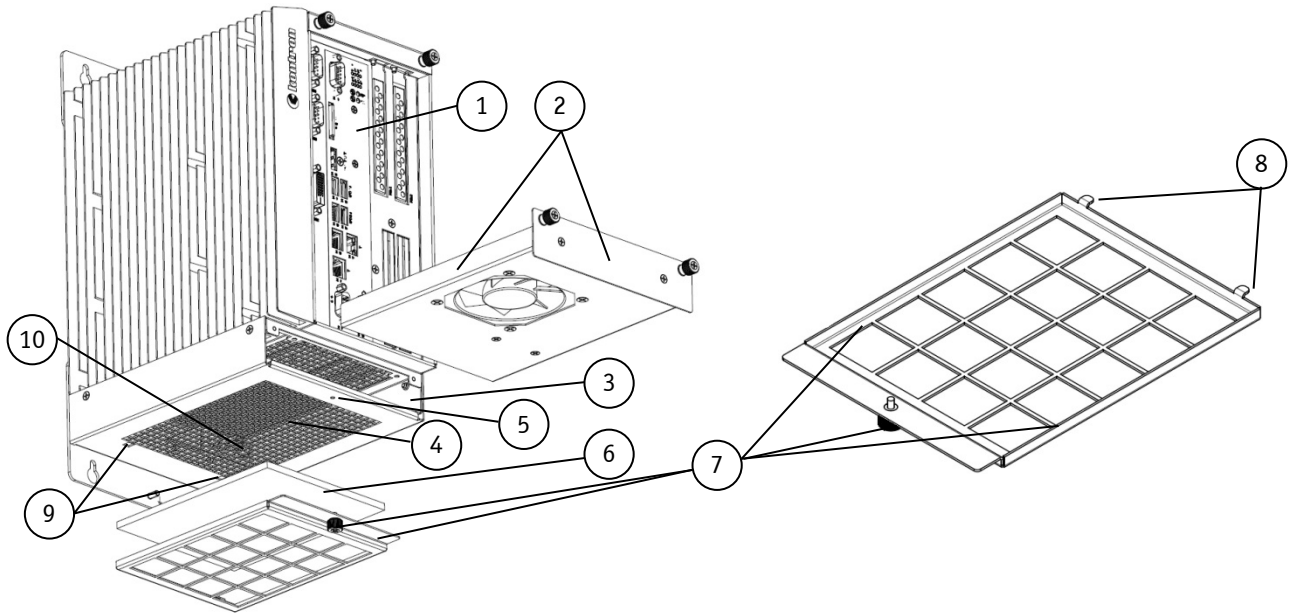

Fig. 54: KBox C-101-2 with removed fan tray and removed air filter

Fig. 55: Holder without air filter

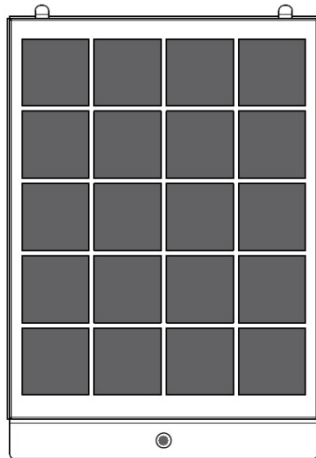

Fig. 56: Holder (shown for a KBox C-101-2) with air filter

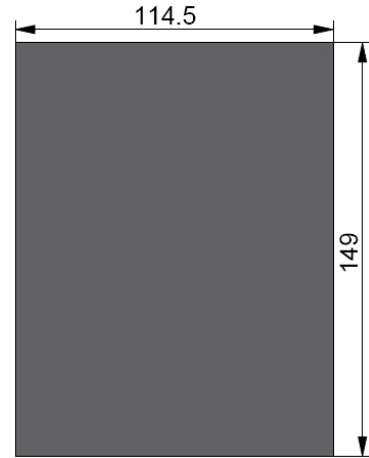

Fig. 57: Air filter (shown for a KBox C-101-2)

Legend for Fig. 54 and Fig. 55:

- | | |
|--|--|
| 1 KBox C-101 assembled with the optional fan tray slot | 6 Removed air filter |
| 2 Removed fan tray | 7 Air filter holder with knurled screw |
| 3 Fan tray slot without inserted fan tray | 8 Positioning latches of the air filter holder |
| 4 Air intake openings at the bottom side of the fan tray slot | 9 Positioning holes for the air filter holder |
| 5 Tapped hole to secure the knurled screw of the air filter holder | 10 Socket for fan power and control (on internal rear side of the fan tray slot) |

14. KBox C-101-2 Variant

Please refer to the description in this manual for KBox C-101 and chapter 17 “Technical Specifications”.

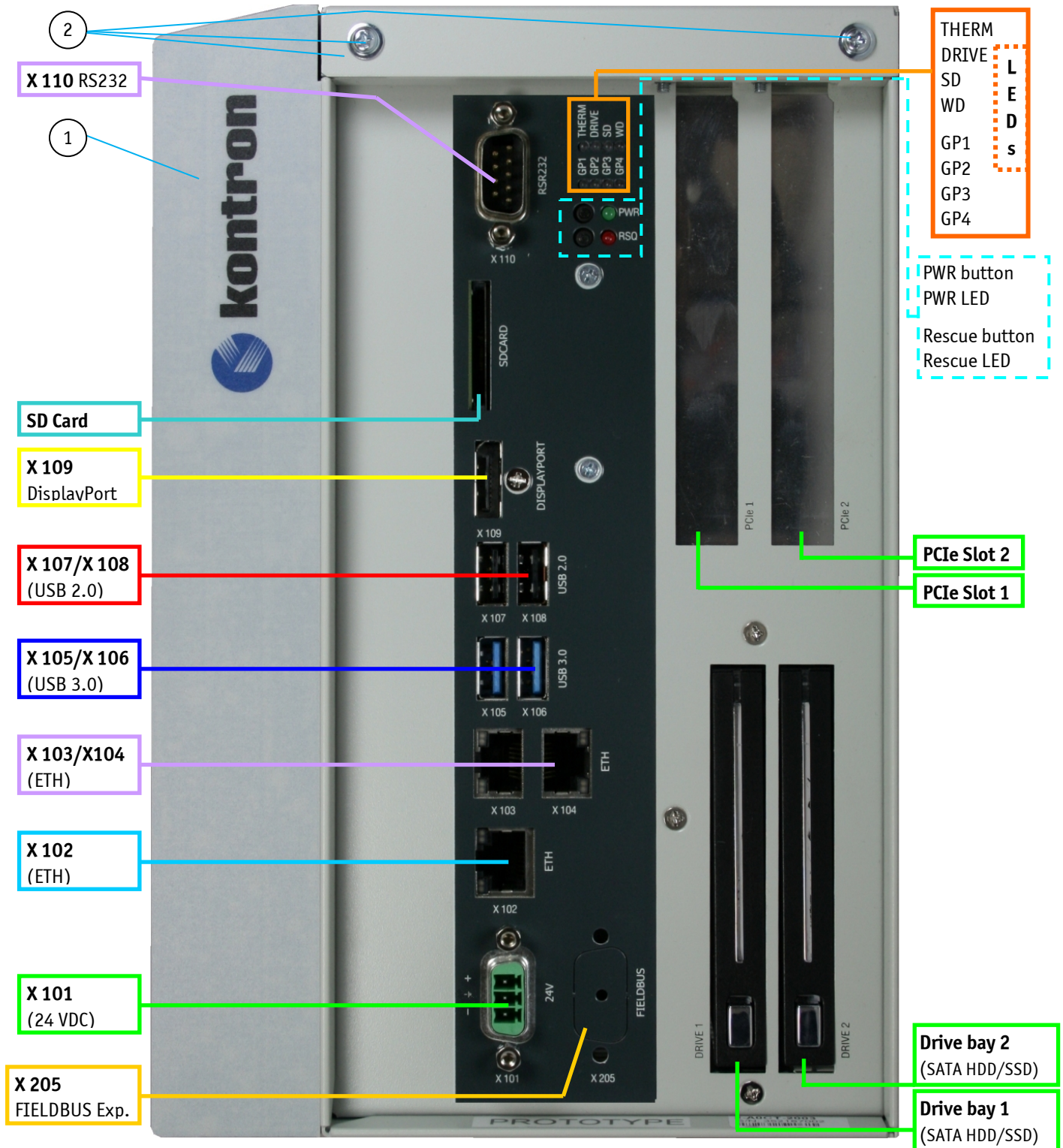

Fig. 58: KBox C-101-2 - front view (shown with removable drive bays and without mounting brackets)

- 1 Side of KBox C-101-2 with cooling fins
- 2 Top side cover with knurled screws

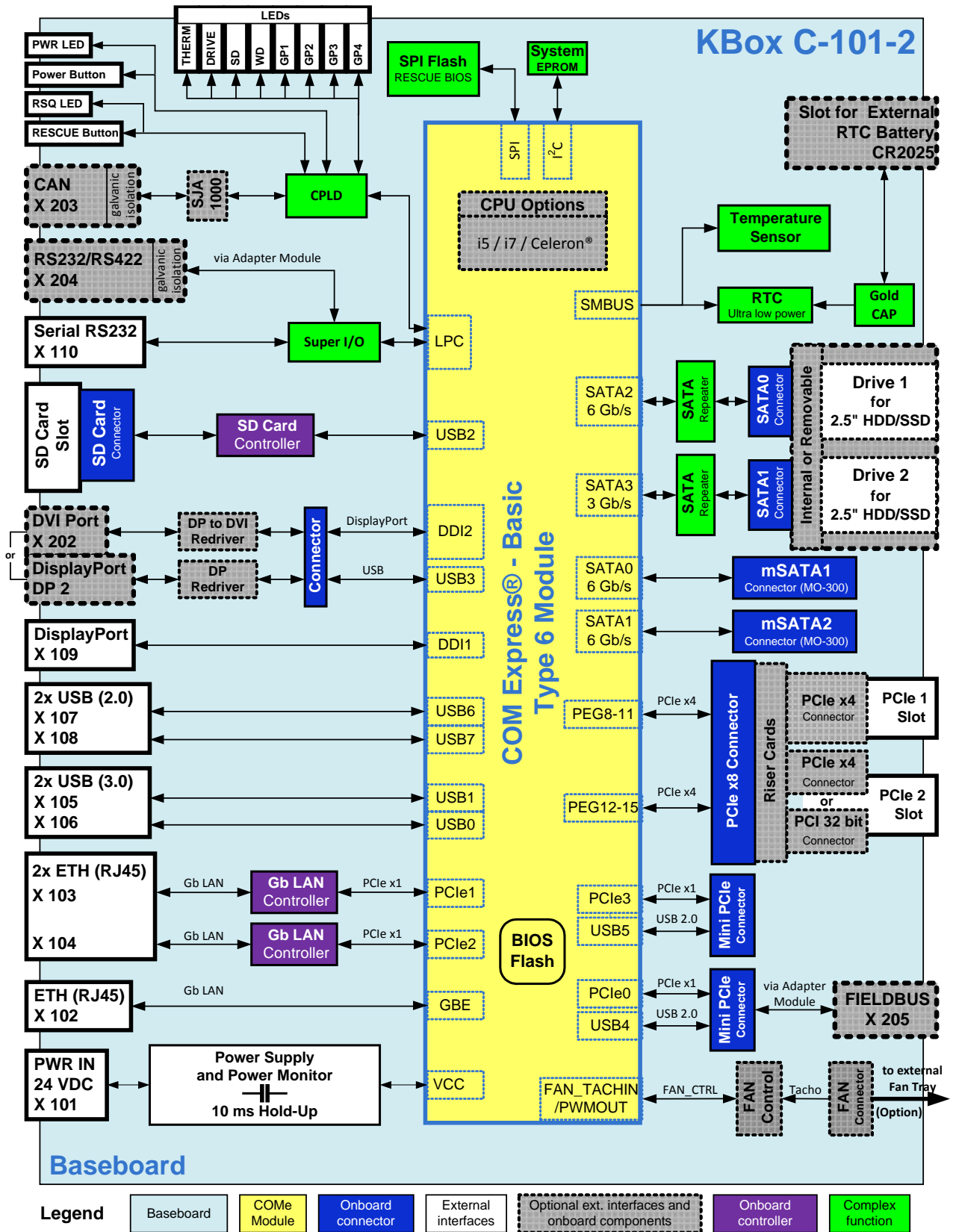

Fig. 59: Block Diagram - KBox C-101-2

15. KBox C-101-1 Variant

Please refer to the description in this manual for KBox C-101 and chapter 17 “Technical Specifications”.

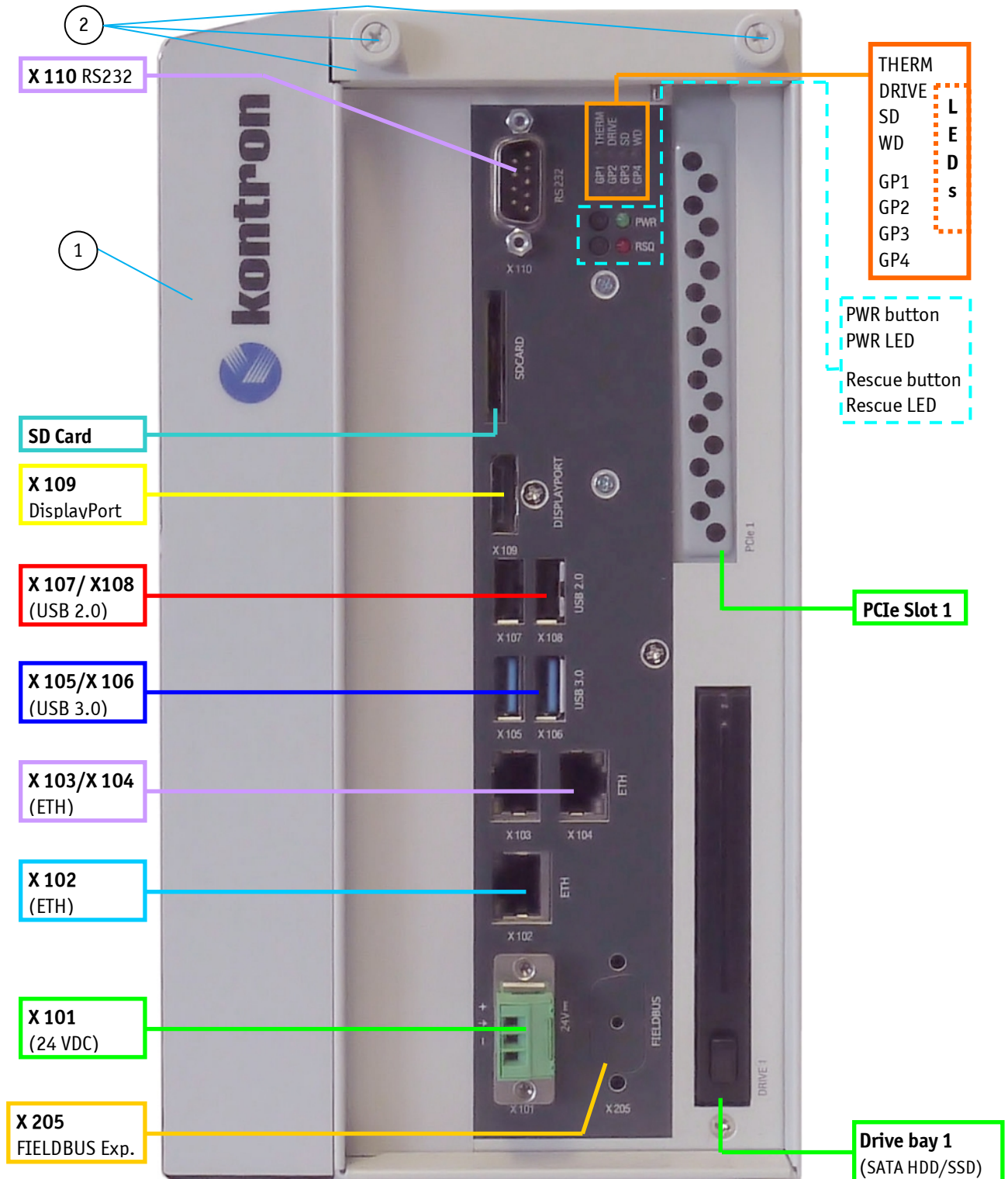
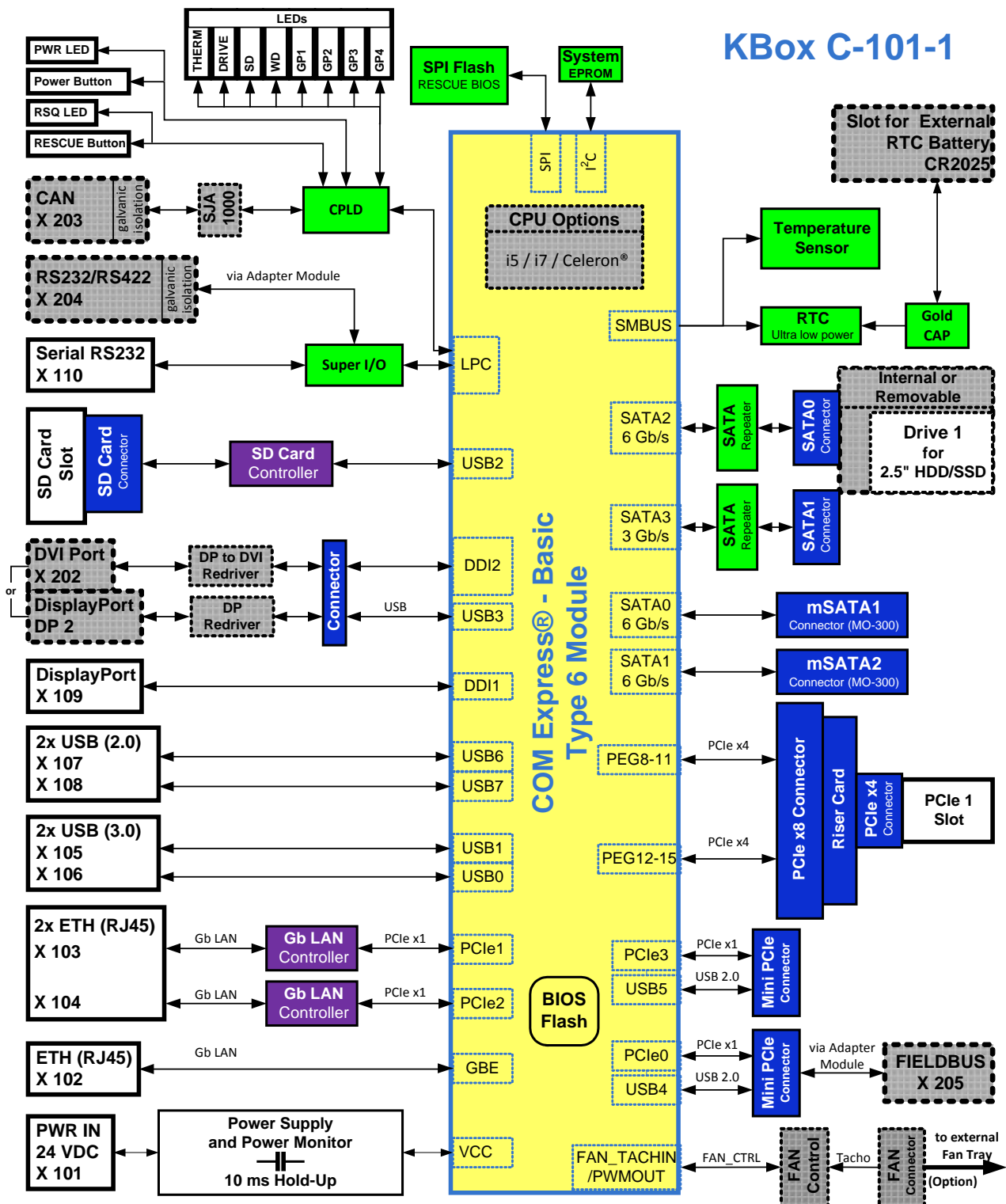

Fig. 60: KBox C-101-1 - front view (shown with removable drive bay without mounting brackets)

- 1 Side of KBox C-101-1 with cooling fins
- 2 Top side cover with knurled screws

KBox C-101-1



Baseboard

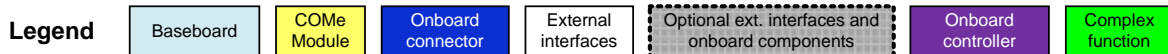

Fig. 61: Block Diagram - KBox C-101-1

15.1. KBox C-101-1 - System Expansion Capabilities



Please observe that the KBox C-101-1 can be equipped with only one internal 2.5" SATA HDD/SSD or one removable 2.5" SATA HDD/SSD.

Only the "PCIe 1" slot for one PCIe x4/PCIe x1 expansion card is available on the front side of the system.

Refer also to subsection 7.4.

For system design refer also to Fig. Fig. 60, Fig. 61, chapter 18 "Technical Specifications" and subsection 17.1.3 and 17.1.4.

15.1.1. PCIe Expansion Slot 1

The KBox C-101-1 provides at the front side one "PCIe 1" slot (Fig. 60,). You can install a half-length PCIe x4 or PCIe x1 expansion card. To access the PCIe x4 socket in order to install or remove the PCIe expansion card you have to remove the top side access cover. For a better accessibility of the expansion socket you should remove the right side access cover (Fig. 30 and Fig. 28, pos. 1 and pos. 3) also; (the description in subsection 7.5 "Left and Right Side View" is valid also for KBox C-101-1).

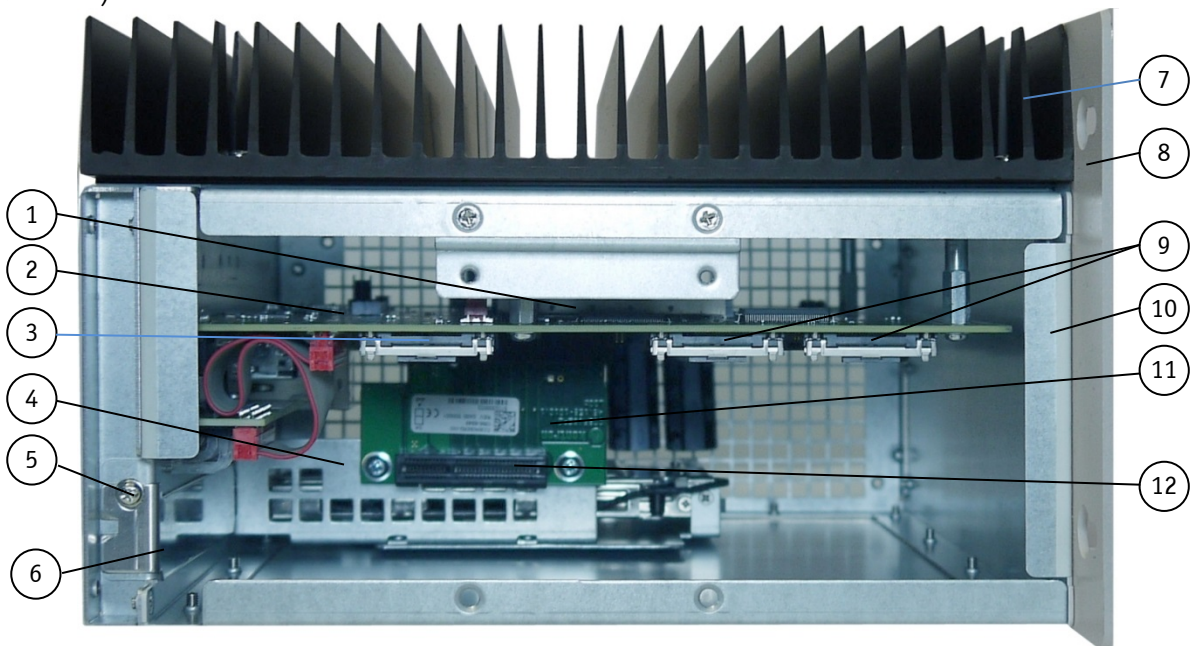

Fig. 62: Inside of the KBox C-101-1 (shown with a removable HDD)

- | | |
|---|---|
| 1 COM Express module | 7 Cooling fins |
| 2 Baseboard | 8 Upper mounting bracket with key holes |
| 3 Mechanical fixing assemblies for 1x PCIe mini card;
(two fixing bolts for each PCIe mini card) | 9 Mechanical fixing assemblies for 2x 2.5" mSATA SSD
(two fixing bolts for each mSATA SSD) |
| 4 Installed removable 2.5" drive bay (not included) | 10 Cover retaining plate on the rear side |
| 5 Screw to secure the expansion slot/card bracket | 11 Riser card with 1x PCIe x4 expansion socket |
| 6 Slot bracket for the for the PCIe 1 expansion slot | 12 Free PCIe x4 socket (for PCIe 1 slot) |

For installation/removing of the PCIe expansion card (installed into the "PCIe 1" slot) refer to subsection 9.3.5 "Installing/Removing the PCI/PCIe Expansion Cards", with observation that only one PCIe slot is available ("PCIe 1").



Please observe that for KBox C-101-1 only one PCIex4/PCIe x1 expansion card can be installed into the available PCIe x4 socket of the riser card (Fig. 62, pos. 11 and pos. 12).

15.1.2. Internal or Removable 2.5" SATA HDD/SSD

Depending on the ordered system configuration, your KBox C-101-1 can be equipped with one 2.5" SATA removable drive bay (refer to Fig. 60, "DRIVE 1") or one internal mounting frame for 2.5" SATA HDD/SSD.

The internal 2.5" HDD/SSD is not accessible from the outside. The internal SATA HDD/SSD is installed (always factory installed) into the system by the use of a mounting frame.

The drive bay (DRIVE 1) for removable 2.5" SATA HDD/SSD is accessible from the front side of the system.

This interface of the KBox C-101-1 system (if internal or external accessible) supports speeds of up to SATA 6 Gb/s.



This SATA interface supports hot-swapping.

To prevent data loss, don't remove the HDD/SSD during read/write activity [while the "DRIVE LED" (Fig. 22) is flashing green].



Your KBox C-101-1 can be equipped with one drive bay for a removable HDD/SSD (refer to Fig. 60, "DRIVE 1") or one internal mounting frame for a 2.5" SATA HDD/SSD.

If the KBox C-101-1 configuration with internal 2.5" SATA HDD/SSD was ordered, the "DRIVE 1" for removable 2.5" SATA SATA HDD/SSD is not available on the front side of the system; refer to Fig. 9, under consideration of the system design (Fig. 60, Fig. 61) and mechanical differences (see 17.1.3 and 17.1.4).

Refer also to the area marked "D" in section 7.4.

This page has been intentionally left blank.

16. KBox C-101-0 Variant

Please refer to the description in this manual for KBox C-101 and chapter 17 “Technical Specifications”.

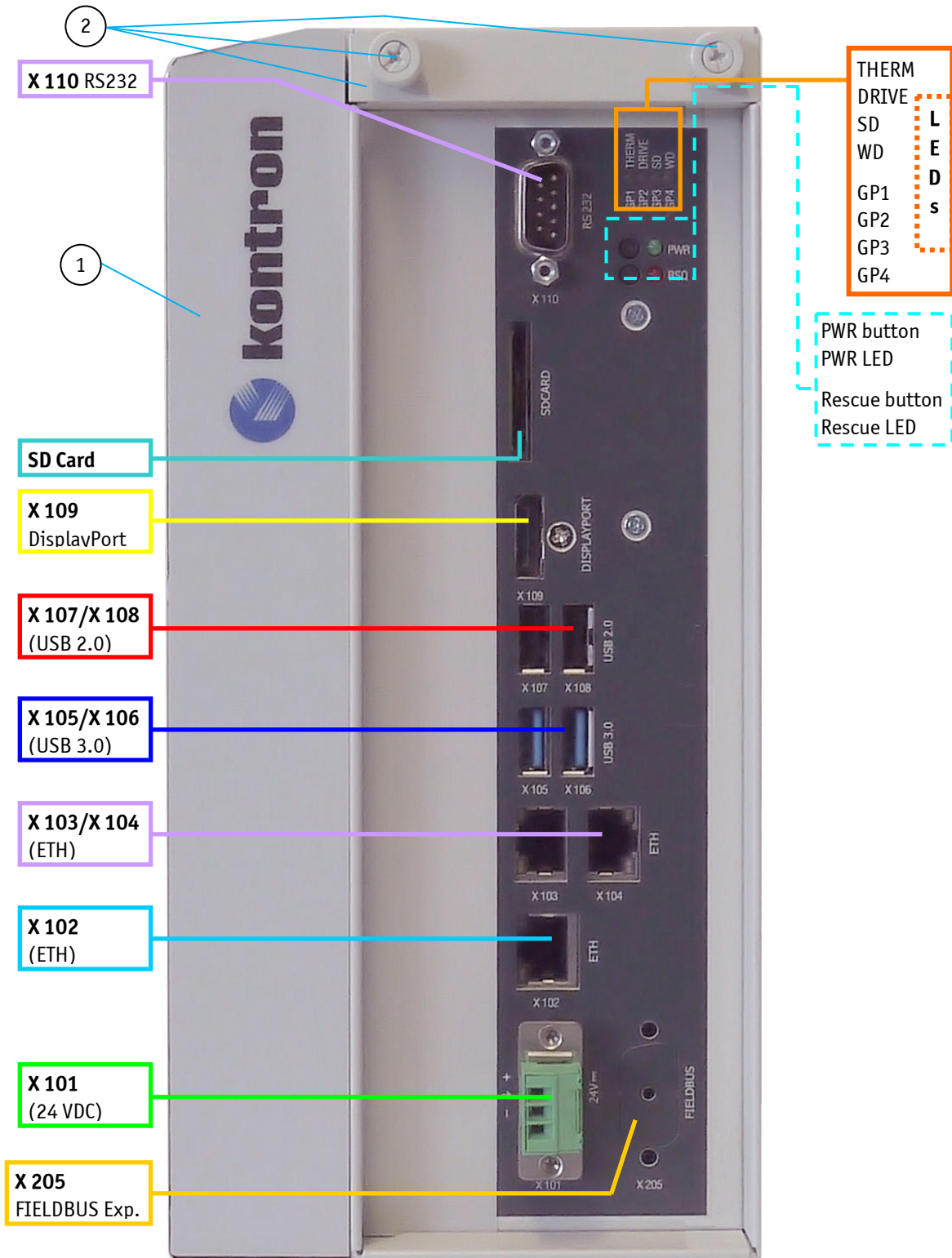

Fig. 63: KBox C-101-0 - front view (shown without mounting brackets)

- 1 Side of KBox C-101-0 with cooling fins
- 2 Top side cover with knurled screws

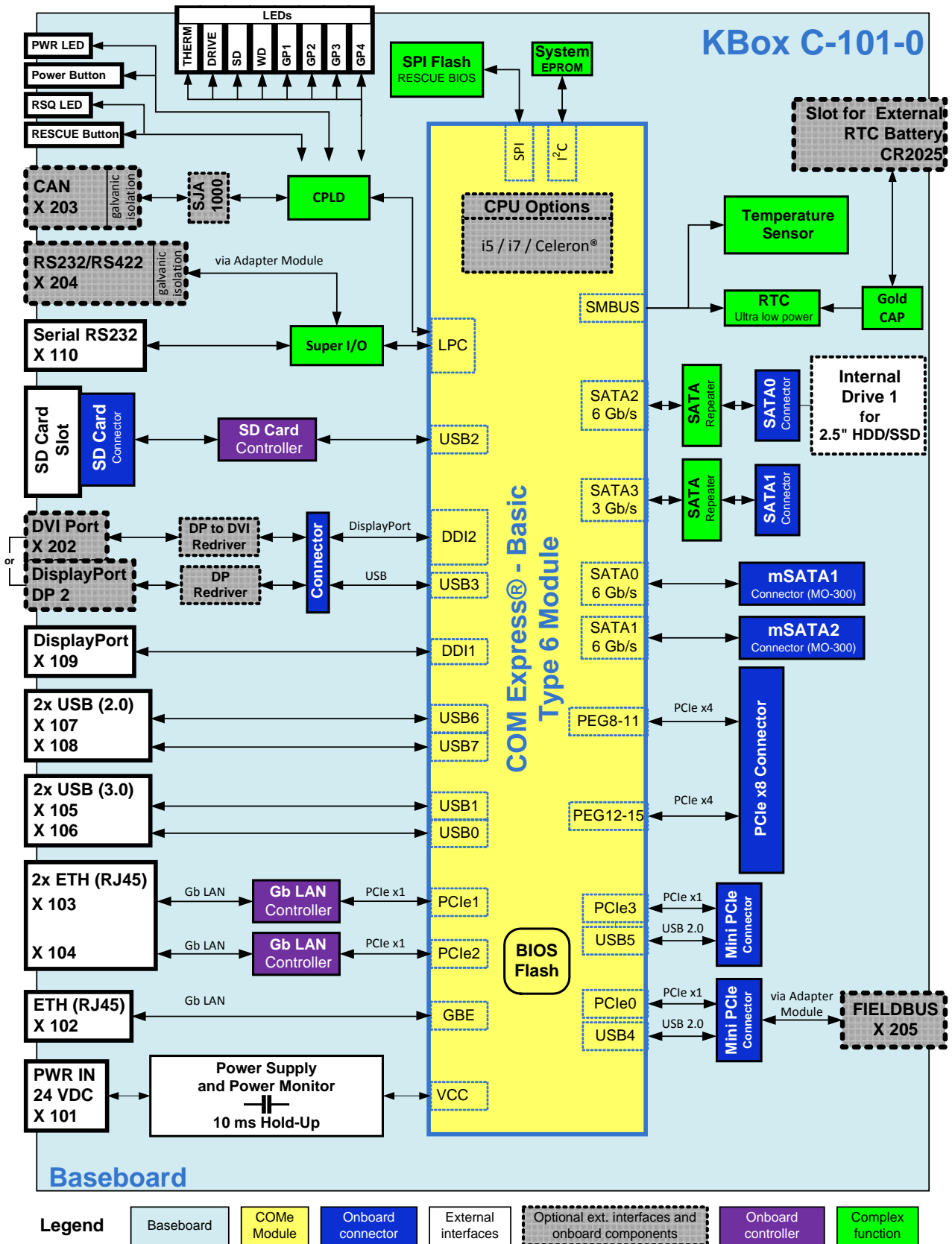

Fig. 64: Block Diagram - KBox C-101-0

16.1. KBox C-101-0 - System Expansion Capabilities



Please observe that the KBox C-101-0 can be equipped with only one internal 2.5" SATA HDD/SSD. No external accessible removable drive bay and PCIe slot are available on the front side. Refer also to subsection 7.4.

For system design refer also to Fig. 63, Fig. 64, chapter 17 "Technical Specifications" and subsection 17.1.5 "Mechanical Specifications of the KBox C-101-0".

16.1.1. Internal 2.5" SATA Drive

The KBox C-101-0 can be equipped with only one internal 2.5" SATA HDD/SSD (always factory installed). The picture below shows the KBox C-101-0 configuration with the internal 2.5" SATA SSD (installed into the mounting frame).

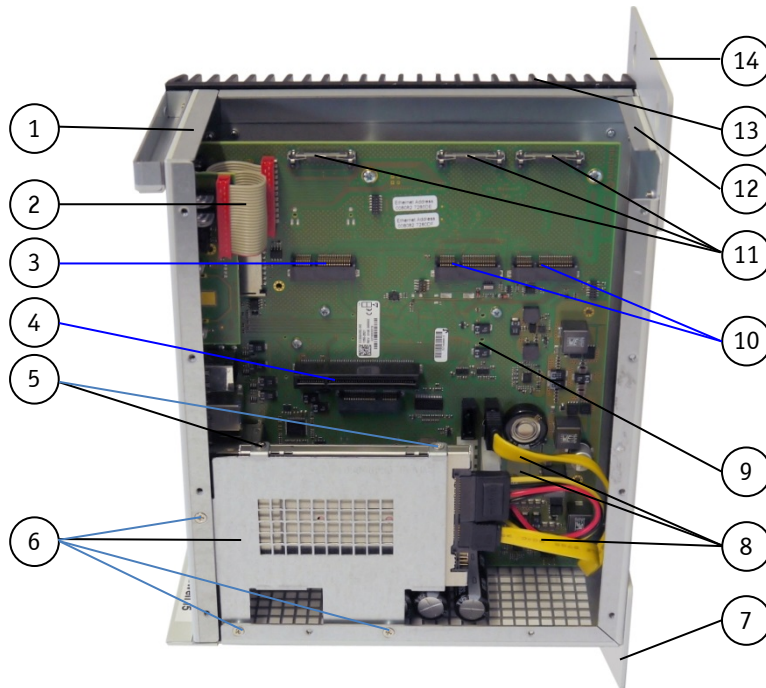

Fig. 65: KBox C-101-0 - internal view with the internal HDD/SSD drive

- | | |
|---|--|
| 1 Cover retaining bracket on the front side | 8 1x SATA cable connections (power and data) |
| 2 LED indicators circuit | 9 Baseboard |
| 3 1x Mini PCIe socket for PCIe mini card (please observe the note below) | 10 2x mSATA sockets |
| 4 PCI x8 socket (not used in this configuration) | 11 Mechanical fixing assemblies for:
2x 2.5" mSATA SSD and 1x PCIe mini card (two fixing bolts for each mSATA SSD and PCIe mini card) (please observe the note below) |
| 5 Screws that secure the internal 2.5" SATA HDD/SSD into the mounting frame | 12 Cover retaining bracket on the rear side |
| 6 Mounting frame for the 1x internal 2.5" SATA HDD/SSD and screws that secure it to the chassis | 13 Cooling fins |
| 7 Lower mounting bracket with key holes | 14 Upper mounting bracket with key holes |



The KBox C-101 provides two internal Mini PCIe sockets. You can see one of them in Fig. 42, pos. 4. The second Mini PCIe socket is on the bottom side of the baseboard and can be only at factory equipped with an expansion card.

17. Technical Specifications

KBox C-101 Family			
Installed COM Express Module and Baseboard	Baseboard with COMe-bHL6 i5-4402E or Baseboard with COMe-bHL6 i7-4700EQ or Baseboard with COMe-bHL6 Celeron® 2002E		
Processor	i5-4402E: Dual-Core 1.6 GHz, 3MB cache, 25 W max. power consumption, i7-4700EQ: Quad-Core 2.4 GHz, 6MB cache, 47 W max. power consumption, Celeron® 2002E, Dual-Core 1.5 GHz, 2MB cache, 25 W max. power consumption		
RAM	Up to 16 GB		
BIOS	Phoenix uEFI		
Controls (at the front side)	Power button (PWR) RESCUE button (RSQ)		
Indicators (at the front side)	PWR (Power LED) RSQ (Rescue LED) THERM (Thermal LED) DRIVE (HDD/SSD status LED) SD (SD card status LED) WD (Watchdog status LED) GP1 ... GP4 (General Purpose LEDs)		
Interfaces (front side accessible)	3x Ethernet (10/100/1000 Mbit/s) 2x USB 3.0 2x USB 2.0 1x DisplayPort 1x SD card slot 1x RS232 Optional: 1x FIELDBUS (PROFIBUS or CAN BUS)	Options: 1x Serial port (RS232/RS422) 1x CAN 1x DVI-D or 1x DisplayPort (DP 2)	
DC IN Connector (at the front side)	3-pin DC input connector		
Protection Class	IP20		
Lithium Battery (Option) (front side accessible)	CR 2025, 3 V		
Rated Voltage (tolerance)	24 VDC (+20%/-15%), 10ms hold-up		
System power consumption	144 W maximum permitted load including all optional/peripheral devices (SSD/HDDs, PCIe expansion cards)		
	KBox C-101-2	KBox C-101-1	KBox C-101-0
Options for Storage Media	2x 2.5" SATA HDD/SSD non-removable or 2x 2.5" removable SATA HDD/SSD for: • DRIVE 1: SATA 6 Gb/s. • DRIVE 2: SATA 3 Gb/s. Up to 2x mSATA 1x SD card	1x 2.5" SATA HDD/SSD non-removable or 1x 2.5" removable SATA HDD/SSD for: • DRIVE 1: SATA 6 Gb/s. Up to 2x mSATA 1x SD card	1x 2.5" SATA HDD/SSD non-removable Up to 2x mSATA 1x SD card
Free Expansions Sockets (internal)	2x full size Mini PCIe x1 2x PCIe x4 or 1x PCI (32 bit) and 1x PCIe x4 (via corresponding riser card) (power consumption less than 15 W is allowed)	2x full size Mini PCIe x1 1x PCIe x4 (via corresponding riser card) (power consumption less than 15 W is allowed)	2x full size Mini PCIe x1
Fan Tray (Option)	yes	yes	no

17.1. Mechanical Specifications of the KBox C-101

17.1.1. Mechanical Specifications of the KBox C-101-2

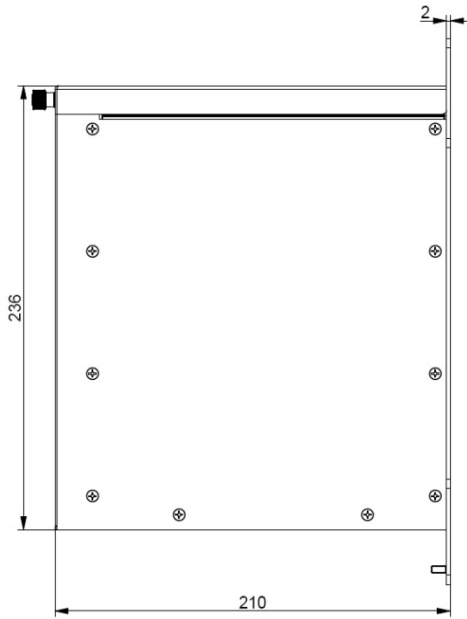

Fig. 66: Dimensions: Right side (KBox C-101-2)

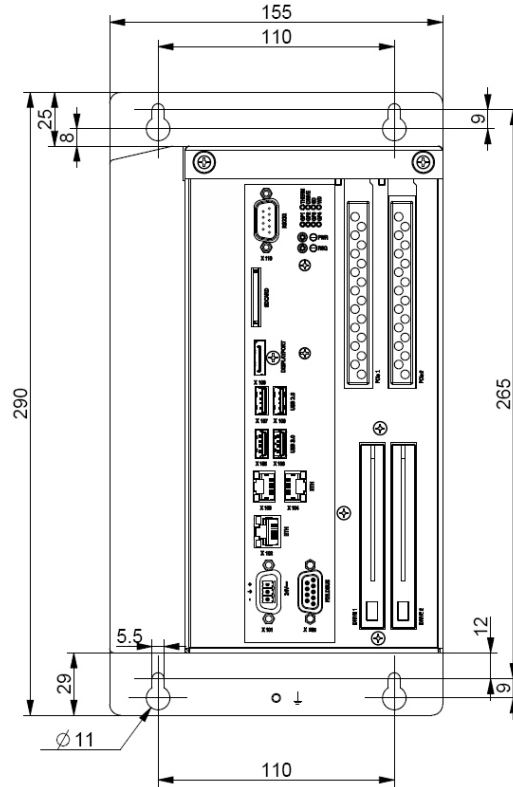

Fig. 67: Dimensions: Front side with keyholes (KBox C-101-2)

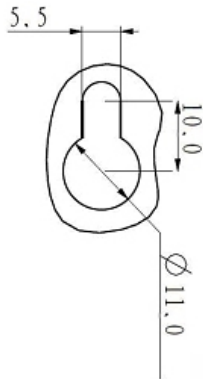

Fig. 68: Dimensions: Keyhole in detail (KBox C-101-2)

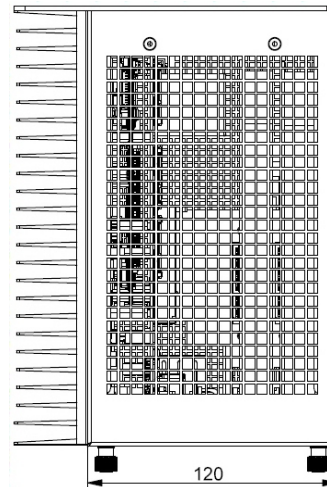

Fig. 69: Dimensions: top side (KBox C-101-2)

17.1.2. Mechanical Specifications of the KBox C-101-2 with Fan Tray Option

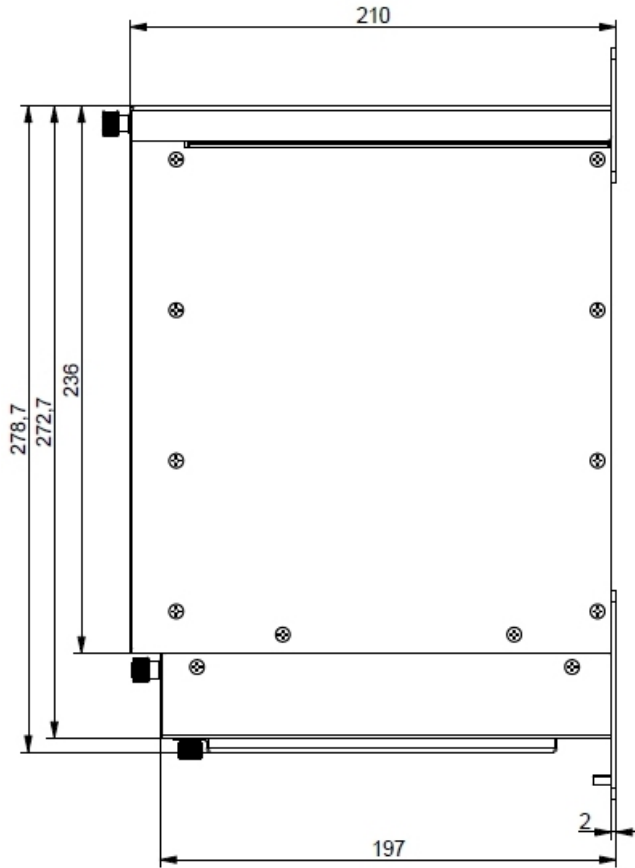

Fig. 70: Dimensions: Right side (KBox C-101-2 with fan tray option)

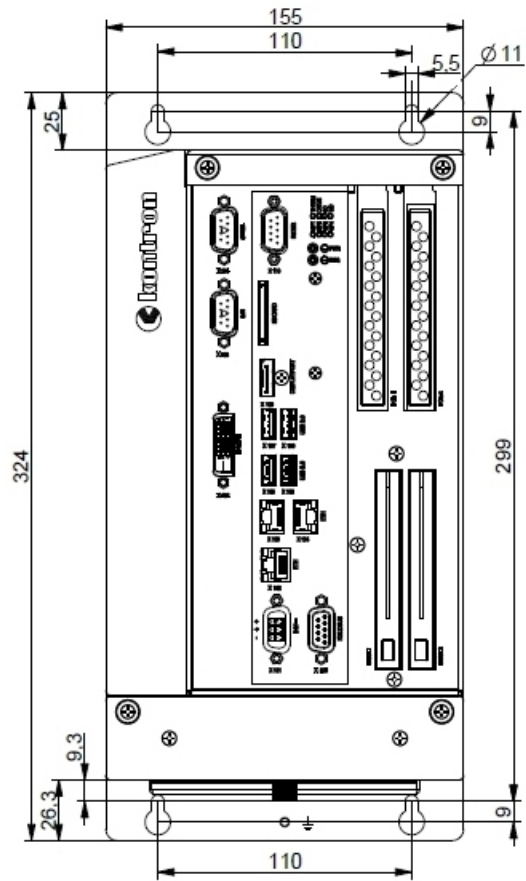

Fig. 71: Dimensions: Front side with keyholes (KBox C-101-2 with fan tray option)

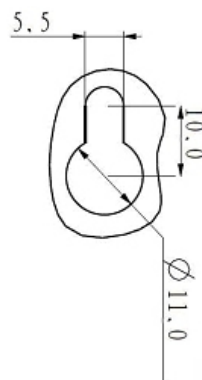

Fig. 72: Dimensions: Keyhole in detail (KBox C-101-2 with fan tray option)

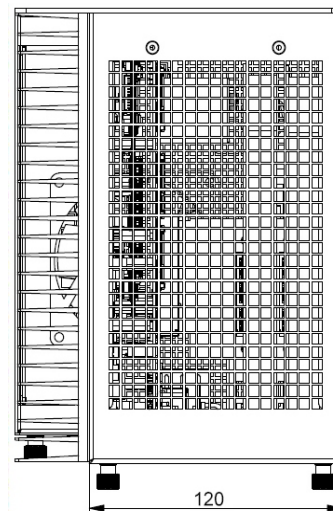

Fig. 73: Dimensions: Top side (KBox C-101-2 with fan tray option)

Dimensions	KBox C-101-2 (Standard Version)	KBox C-101-2 (with optional Fan Tray)
Height	with mounting brackets: 290 mm (11.42")	with mounting brackets: 324 mm (12.756")
Width	155 mm (6.10")	155 mm (6.10")
Depth	with mounting brackets: 210 mm (8.26")	with mounting brackets: 210 mm (8.26")
Weight (without packaging, without expansions)	Approx. 4.75 kg (10.47 lbs.)	Approx. 6.00 kg (13.22 lbs.)
Chassis	Cooling fins, black Chassis: Steel sheet, light grey (RAL 7035) Side with external interfaces : Trim strips, traffic grey (RAL 7043)	

17.1.3. Mechanical Specifications of the KBox C-101-1

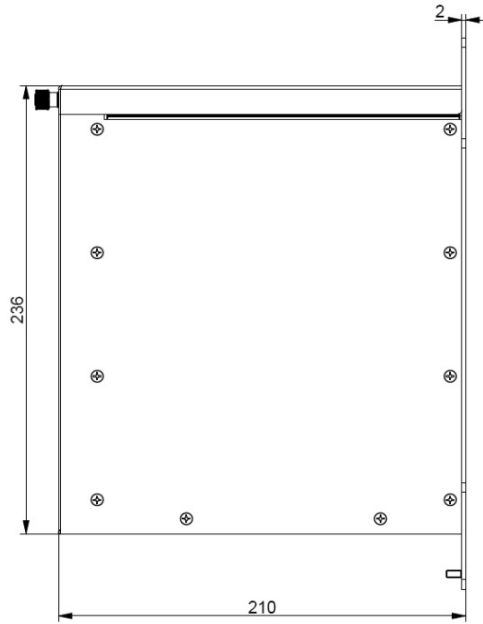

Fig. 74: Dimensions: right side (KBox C-101-1)

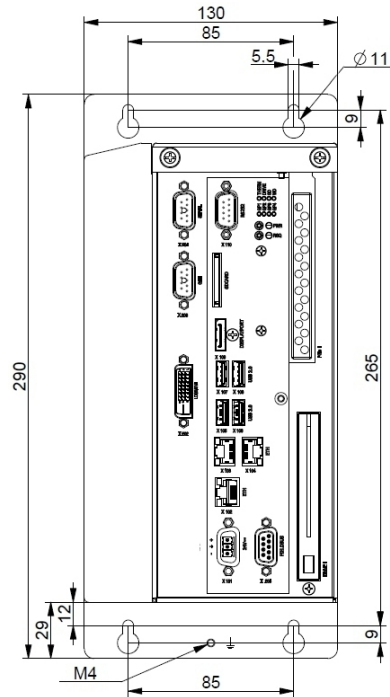

Fig. 75: Dimensions: Front side with keyholes (KBox C-101-1)

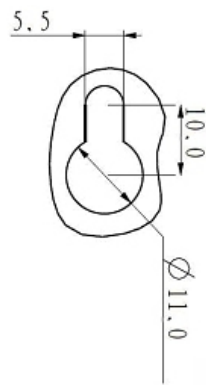

Fig. 76: Dimensions: Keyhole in detail (KBox C-101-1)

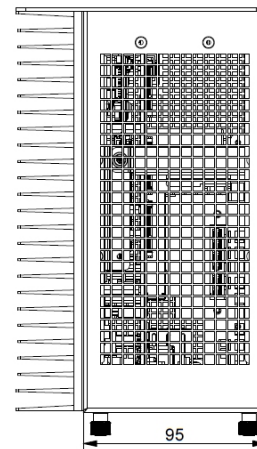

Fig. 77: Dimensions: Top side (KBox C-101-1)

17.1.4. Mechanical Specifications of the KBox C-101-1 with Fan Tray Option

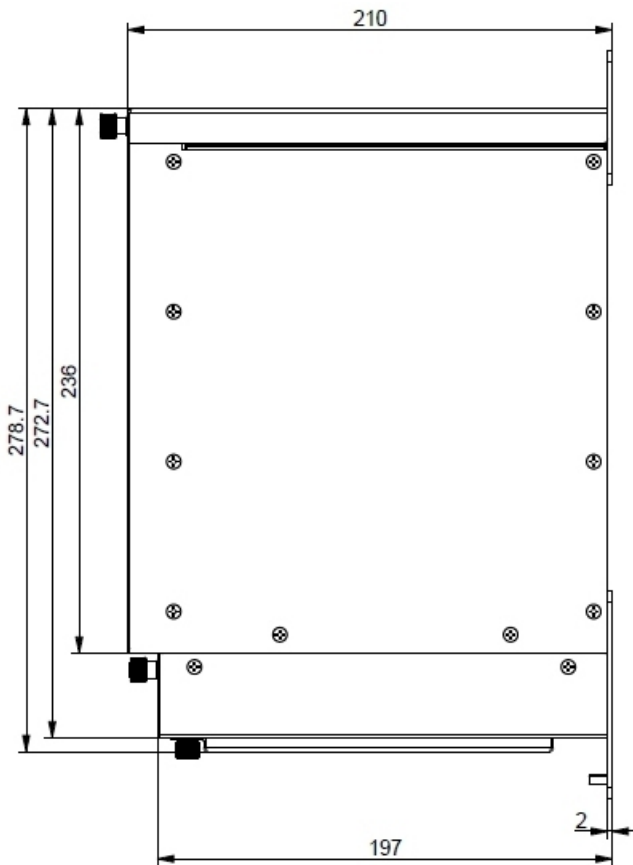

Fig. 78: Dimensions: Right side (KBox C-101-1 with fan tray option)

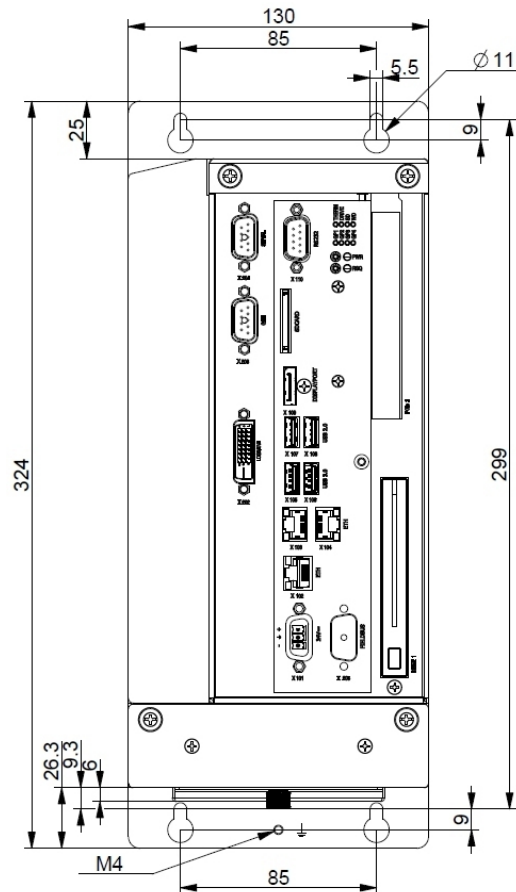

Fig. 79: Dimensions: Front side with keyholes (KBox C-101-1 with fan tray option)

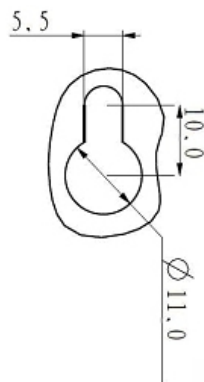

Fig. 80: Dimensions: Keyhole in detail (KBox C-101-1 with fan tray option)

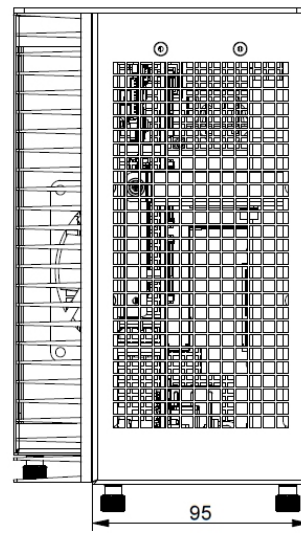

Fig. 81: Dimensions: Top side (KBox C-101-1 with fan tray option)

Dimensions	KBox C-101-1 (Standard Version)	KBox C-101-1 (with optional Fan Tray)
Height	with mounting brackets: 290 mm (11.42")	with mounting brackets: 324 mm (12.756")
Width	130 mm (5.12")	130 mm (5.12")
Depth	with mounting brackets: 210 mm (8.26 ")	with mounting brackets: 210 mm (8.26 ")
Weight (without packaging, without expansions)	Approx. 4.6 kg (10.14 lbs.)	Approx. 5.6 kg (12.34 lbs.)
Chassis	Cooling fins, black Chassis: Steel sheet, light grey (RAL 7035) Side with external interfaces : Trim strips, traffic grey (RAL 7043)	

17.1.5. Mechanical Specifications of the KBox C-101-0

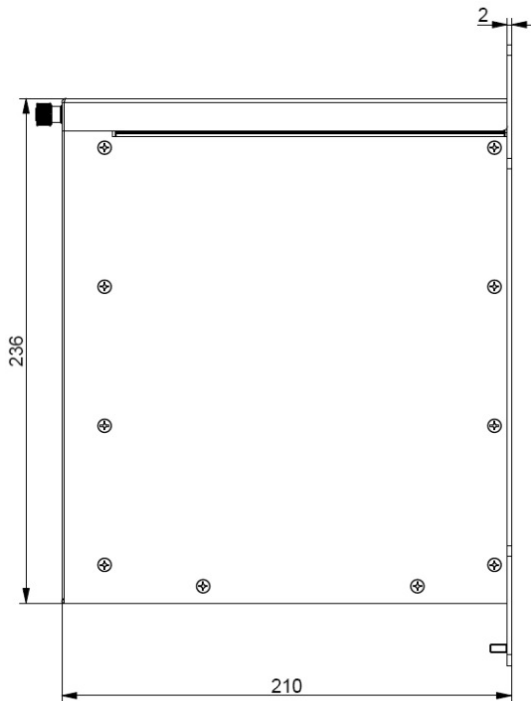

Fig. 82: Dimensions: Right side (KBox C-101-0)

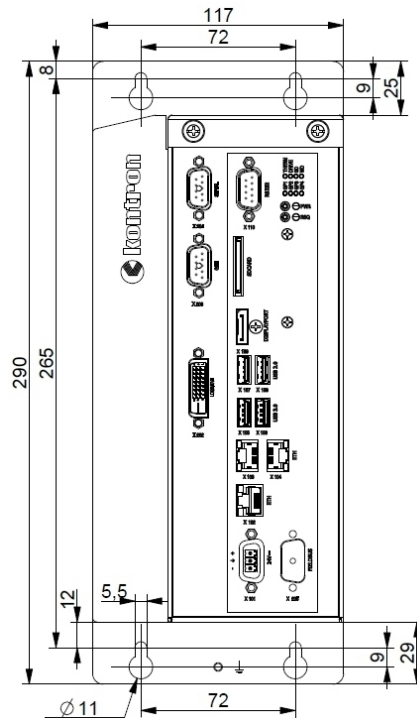

Fig. 83: Dimensions: Front side with keyholes (KBox C-101-0)

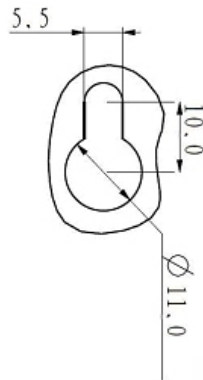

Fig. 84: Dimensions: Keyhole in Detail(KBox C-101-0)

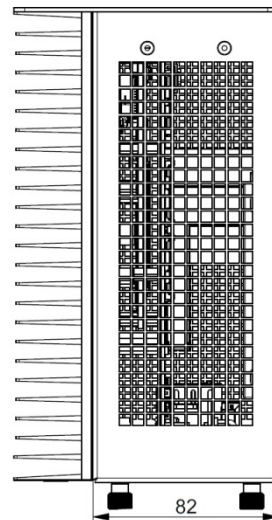

Fig. 85: Dimensions: top side (KBox C-101-0)

Dimensions	KBox C-101-0 (Standard Version)
Height	with mounting brackets: 290 mm (11.42")
Width	117 mm (4.61")
Depth	with mounting brackets: 210 mm (8.26 ")
Weight (without packaging, without expansions)	Approx. 3.8 kg (8.37 lbs.)
Chassis	Cooling fins, black Chassis: Steel sheet, light grey (RAL 7035) Side with external interfaces : Trim strips, traffic grey (RAL 7043)

17.2. Environmental Specifications

	KBox C-101	
Thermal management	Convection cooling	
Operating temperature	with Core™ i5-4402E:	0 °C to +65 °C (32 °F to 149 °F)
	with Core™ i7-4700EQ:	0 °C to +50 °C (32 °F to 122 °F)
Storage/transit temperature (for system config. without ext. CMOS battery)	-40°C ... +85°C (-40°F ... +185°F)	
Storage/transit temperature (for system config. with ext. CMOS battery)	with SSD:	-20 °C to +80 °C (-4 °F to +176 °F)
	with HDD:	-20 °C to +70 °C (-4 °F to 158 °F)
Relative humidity (operating)	93 % @ 40 °C (non condensing) acc. to IEC 60068-2-78	
Max. operation altitude	2,000 m (6,560 ft.)	
Max. storage/transit altitude	10,000 m (32,810 ft.)	
Operating shock	15 G, 11 ms, half sine, acc. to IEC 60068-2-27:2010-2	
Operating vibration	5 Hz to 57.6 Hz, 0.075mm amplitude 57.6 Hz to 150 Hz, 1 G acc. to IEC 60068-2-6:2008-10	

17.3. CE-Directives, Standards and Approvals

CE Directive	
Elektrical Safety	General Product Safety Directive (GPSD) 2001/95/EC Low Voltage Directive (LVD) 2006/95/EC
Electromagnetic Compatibility (EMC)	EMC Directive 2004/108/EC
CE Marking	CE Directive 93/68/EEC
RoHS II Directives	2011/65/EU

Elektrical Safety	Harmonised Standards
EUROPE	Information technology equipment - Safety - Part 1: General requirements EN 60950-1:2006+A11:2009+A12:2011+A1:2010+AC:2011
U.S.A. / CANADA	Conform UL STD 60950-1 Conform UL STD 508 Certified to CAN/CSA C22.2 No. 60950-1/UL 60950-1 Tested according UL 508
CB Report	IEC 60950-1(ed.2);am1, am2
Listed Mark	ETL

EMC	Harmonised Standards
EU	Generic standards - Emission standard for industrial environments (Emission): EN 55011, Class B (conducted emission) EN 55022, Class B EN 61000-6-4 Generic standards - Immunity for industrial environments (Immunity): EN 55024, EN 61000-6-2, EN 61000-4-3 EN61131-2 (Standard for programmable controllers, part 2 equipment requirements and tests)

18. Standard Interfaces – Pin Assignments

Low-active signals are indicated by a minus sign.

18.1.1. (X 101) Power Input Connector

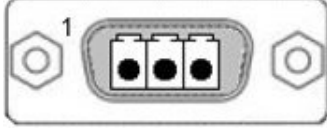
Pin	Signal Name	3-pin POWER SUBCON (male)
1	+24 VDC (input)	
2	Functional Earth	
3	0 V (input)	

18.1.2. (X 110) Serial Interface RS232

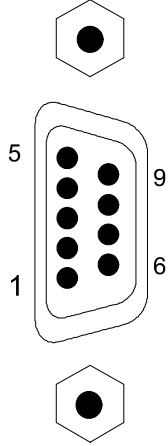
Pin	Signal Name	9-pin D-SUB Connector
1	DCD (Data Carrier Detect)	
2	RXD (Receive Data)	
3	TXD (Transmit Data)	
4	DTR (Data Terminal Ready)	
5	GND (Signal Ground)	
6	DSR (Data Set Ready)	
7	RTS (Request to Send)	
8	CTS (Clear to Send)	
9	RI (Ring Indicator)	

18.1.3. (X 109) DisplayPort

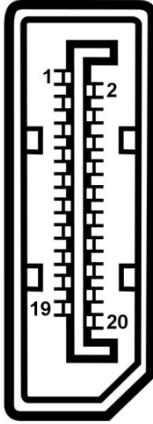
Pin#	Signal Name	DisplayPort	Signal Name	Pin#
1	ML Lane 0 (p)		GND (ML Lane 0)	2
3	ML Lane 0 (n)		Lane 1 (p)	4
5	GND (ML Lane 1)		Lane 1 (n)	6
7	Lane 2 (p)		GND (ML Lane 2)	8
9	Lane 2 (n)		Lane 3 (p)	10
11	GND (ML Lane 3)		Lane 3 (n)	12
13	AUX SEL#		Pull-down to GND	14
15	AUX CH (p)		GND (AUX CH)	16
17	AUX CH (n)		Hot Plug	18
19	GND (GND_DDC)		3.3V (DDC EEPROM power 500 mA fused)	20

18.1.4. (X 107, X 108) USB 2.0 Port

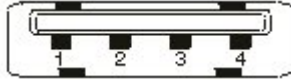
Pin	Signal Name	4-pin USB Connector Typ A Version 2.0
1	VCC	
2	Data-	
3	Data+	
4	GND	

18.1.5. (X 105, X 105) USB3.0 Port

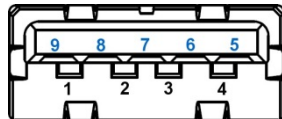
Pin		Signal Name	9-pin USB Connector Type A Version 3.0/2.0
USB 2.0 contact pins	USB 3.0 contact pins		
1	VCC, fused (900 mA max.)	5 StdA_SSRX-	
2	Data-	6 StdA_SSRX+	
3	Data+	7 GND_DRAIN	
4	GND	8 StdA_SSTX-	
		9 StdA_SSTX+	

18.1.6. (X 102, X 103, X 104) Ethernet Connectors

Pin#	Signal Name	3x ETH (RJ45 female)
1	MDIO+	
2	MDIO-	
3	MDI1+	
4	MDI2+	
5	MDI2-	
6	MDI1-	
7	MDI3+	
8	MDI3-	

Speed (Mbps)		LINK/ACT	
		LINK	ACTIVE
10	off	on	orange on (blinking)
100	green	on	orange on (blinking)
1000	orange	on	orange on (blinking)

18.2. Optional Interfaces via Adapter Modules

18.2.1. (X 202) DVI-D (Single Link)

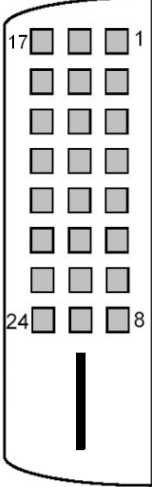
Pin	Signal Name	Description	DVI-D Connector (female)
1	TMDS2-	Differential TMDS Data 2-	
2	TMDS2+	Differential TMDS Data 2+	
3	GND	TMDS Shield	
4-5	NC		
6	DVI_SCL	DDC EDID data clock	
7	DVI_SDA	DDC EDID data	
8	NC		
9	TMDS1-	Differential TMDS Data 1-	
10	TMDS1+	Differential TMDS Data 1+	
11	GND	TMDS Shield	
12-13	NC		
14	DVI_5V	5V / 100mA Power Supply	
15	GND	Ground	
16	DISPDET	Hot Plug Detection	
17	TMDS0-	Differential TMDS Data 0-	
18	TMDS0+	Differential TMDS Data 0+	
19	GND	TMDS Shield	
20-21	NC		
22	GND	TMDS Shield	
23	TMDSSCL+	Differential TMDS Clock+	
24	TMDSSCL-	Differential TMDS Clock -	

18.2.2. (X 202) DP 2 - DisplayPort

For Pin assignment refer to 18.1.3.

18.2.3. (X 204) Serial Port RS232/RS422



This port must be factory installed and configured only. When you order the KBox C-101 with this extended interface via RS232/422 adapter module, you have to specify in your ordering:

- the needed configuration of this port as RS232 or RS422 and
- for RS422 configuration: if the onboard termination resistor (120 Ω) should be enabled or disabled.

18.2.3.1. Serial Port RS232/RS422 configured as RS232

Pin	Signal Name	9-pin D-SUB Plug (male)
1	DCD (Data Carrier Detect)	
2	RxD (Receive Data)	
3	TxD (Transmit Data)	
4	DTR (Data Terminal Ready)	
5	GND (Signal Ground)	
6	DSR (Data Set Ready)	
7	RTS (Request to Send)	
8	CTS (Clear to Send)	
9	RI (Ring Indicator)	

18.2.3.2. Serial Port RS232/RS422 configured as RS422

Pin	Signal Name	9-pin D-SUB Connector (female)
1	NC	
2	RxD- (Receive Data-)	
3	TxD- (Transmit Data-)	
4	NC	
5	GND (Signal Ground)	
6	NC	
7	TxD+ (Transmit Data+)	
8	RxD (Receive Data+)	
9	NC	

18.2.4. (X 203) CAN Bus Port



If a termination resistor (120 Ω) is required, you have to make a connection (bridge) between pin 1 and 2, respectively pin 7 and 8, in order to enable the onboard termination resistor (120 Ω).

Pin	Signal Name	9-pin D-SUB Plug (male)
[1	TERM L	
	CAN_L	
	CAN_GND	
4	NC (not connected)	
5	NC (not connected)	
6	NC (not connected)	
[7	CAN_H	
	TERM H	
	NC (not connected)	

19. Technical Support

For technical assistance, please contact our Technical Support department via:

e-mail: support@kontron.com or

web: <http://www.kontron.com/support-and-services>.

Ensure that your request contains the following information:

- unit part number (PN),
- serial number (SN), which can be found on the type label,
- a short description of the faulty behaviour of your system.

For information about Kontron products and services, please visit www.kontron.com.

19.1. Returning Defective Merchandise

Please follow these steps before you return any merchandise to Kontron:

1. Download the corresponding form for returning a device with an RMA No. [RMA (Return of Material Authorization)] from our website <http://www.kontron.com/support-and-services>/RMA Information; contact our Customer department to obtain an RMA No.
e-mail: support@kontron.com
2. Ensure that you have received an RMA number from Kontron Customer Services before returning any device. Write this number clearly on the outside of the package.
3. Describe the fault that has occurred.
4. Please provide the name and telephone number of a person we can contact to obtain more information, where necessary. Where possible, please enclose all the necessary customs documents and invoices.
5. When returning a device:
 - Pack it securely in its original packaging.
 - Enclose a copy of the RMA form with the consignment.

Corporate Offices

Europe, Middle East & Africa	North America	Asia Pacific
Lise-Meitner-Str. 3-5 86156 Augsburg Germany Tel.: +49 (0) 821/0 Fax: +49 (0) 821/111 info@kontron.com	14118 Stowe Drive Poway, CA 92064-7147 USA Tel.: +1 888 294 4558 Fax: +1 858 677 0898 info@us.kontron.com	17 Building,Block #1,ABP. 188 Southern West 4th Ring Beijing 100070, P.R.China Tel.: + 86 10 63751188 Fax: + 86 10 83682438 info@us.kontron.cn

