

» Kontron User's Guide «



KISS 2U V2

User's Guide (Version 1.00)
0-0096-6882

This page is intentionally left blank.

1. Table of Contents

1. Table of Contents	1
1.1. Table of Figures	2
2. Introduction	5
2.1. Symbols used in this Manual	6
3. Important Instructions	7
3.1. Warranty Note	7
3.2. Exclusion of Accident Liability Obligation	7
3.3. Liability Limitation / Exemption from the Warranty Obligation	7
4. Safety Instructions	8
4.1. Operation of Laser Source Devices	8
4.2. Electrostatic Discharge (ESD)	9
4.2.1. Grounding Methods	9
4.3. Instructions for the Lithium Battery	9
5. Electromagnetic Compatibility (Class A Device)	10
5.1. Electromagnetic Compatibility (EU)	10
5.2. FCC Statement (USA)	10
5.3. EMC Compliance (Canada)	10
6. Scope of Delivery	11
6.1. Type Label and Product Identification	11
7. Product Description	12
7.1. Front Side	14
7.1.1. Power Button	15
7.1.2. LED Indicators	16
7.1.3. Ports on the Front Side	16
7.1.4. Front Access Panel	16
7.1.5. Cover fastening screw on the front side	17
7.1.6. Filter Mat and Filter Mat Holder	17
7.1.7. Fan Slide-in Module	17
7.1.8. Drive Bays	17
7.2. Rear Side	18
7.2.1. System Configurations with SBC Cards	18
7.2.2. System Configuration with Motherboard	20
7.2.3. System Configuration with Motherboard and Low Profile Cards	20
7.2.4. Power Supply Version and ON/OFF Switch of the PSU	22
7.2.5. Grounding Stud	23
7.2.6. Fan Slide-In Module and Temperature Sensor	23
7.3. Side View	23
7.4. Installed Motherboard / SBC Card	24
7.5. System Configurations with SBC	24
7.6. System Configuration with Motherboard	25
7.6.1. Riser Card and/or Backplane and available Bays	27
8. Installation and Removal	28
8.1. Attaching the Rubber Feet	28

8.2. Cover	29
8.3. Accessing Internal Components	30
8.3.1. Installing /Removing Expansion Cards	30
8.4. Installation in a 19" Industrial Cabinet	33
9. Starting Up.....	34
9.1. AC Power Connection	34
9.2. DC Power Connection	35
9.2.1. Attaching the Ferrite Core	35
9.2.2. DC Power Cord Connection	36
9.3. Operating System and Hardware Component Drivers	36
10. Maintenance and Prevention.....	37
10.1. Replacing System Fans	37
10.2. Cleaning the Filter Mat	39
10.3. Replacing the Lithium Battery	41
11. Slide Rails (Option)	42
12. Technical Data.....	43
12.1. Electrical Specifications	44
12.2. Mechanical Specifications	44
12.3. Environmental Specifications	44
12.4. Directives and Standards	45
13. Standard Interfaces – Pin Assignments	46
13.1.1. Serial Interface (RS232)	46
13.1.2. VGA Port	46
13.1.3. USB Port	47
13.1.4. PS/2 Keyboard Connector	47
13.1.5. PS/2 Mouse Connector.....	47
14. Technical Support.....	48
14.1. Returning Defective Merchandise	48

1.1. Table of Figures

Fig. 1: Laser radiation warning label	8
Fig. 2: Rackmount version with closed access panel	12
Fig. 3: Desktop version with closed access panel	12
Fig. 4: Rackmount version with opened access panel.....	12
Fig. 5: Desktop version with opened access panel.....	12
Fig. 6: KISS 2U V2 platform	13
Fig. 7: Front (rackmount version) with the front access panel closed.....	14
<i>Fig. 8: 19" bracket with fixing screws</i>	<i>14</i>
Fig. 9: Front (rackmount version) with the front access panel open	15
Fig. 10: Power button on the front	15
Fig. 11: LED indicators	16

Fig. 12: USB ports on the front side.....	16
Fig. 13: Rear side of the KISS 2U V2 with an SBC card (shown with aPCI-760 and a redundant PSU).....	18
Fig. 14: Rear side of the KISS 2U V2 with an SBC card (shown with a PCI-761 and a redundant PSU).....	18
Fig. 15: External ports of PCI-760 SBC card.....	19
Fig. 16: External ports of PCI-761 SBC card.....	19
Fig. 17: Rear side of the KISS 2U V2 with a KTQ45/Flex (here with a wide range power supply).....	20
Fig. 18: Rear side of the KISS 2U V2 with a KTQ67/Flex (shown as a configuration for low profile expansion cards).....	20
Fig. 19: External ports of the KTQ45/Flex motherboard.....	21
Fig. 20: External ports of the KTQ67/Flex motherboard.....	21
Fig. 21: Detail: AC redundant Wide Rang PSU.....	22
Fig. 22: Detail: AC Wide Rang PSU.....	22
Fig. 23: Detail: +24VDC PSU.....	22
Fig. 24: Detail: -48VDC PSU.....	22
Fig. 25: Grounding stud marked with PE symbol.....	23
Fig. 26: Unmarked grounding stud.....	23
Fig. 27: KISS 2U V2 - side view.....	23
Fig. 28: KISS 2U V2 Configuration with PCI 760-SBC (Single Board Computer).....	24
Fig. 29: KISS 2U V2 - Configuration with KTQ45/Flex motherboard.....	25
Fig. 30: KISS 2U V2 - Configuration with KTQ67/Flex motherboard (shown as a config. for low-profile expansion cards). ..	26
Fig. 31: Inside of the cover with fixing brackets.....	29
Fig. 32: Loosen the cover fastening knurled screw on the front side.....	30
Fig. 33: Loosen the knurled screw on the rear side.....	30
Fig. 34: This movment allow you to remove the centring and fixing bracket of the cover from the retaining plate of the chassis.....	31
Fig. 35: Removing the cover.....	31
Fig. 36: Pulled-out card cage for configurations with SBC and motherboard, but not for configurations with motherboard for low profile cards (shownas a KISS 2U V2 system configuration with SBC).....	31
Fig. 37: Opened ferite core with wires.....	35
Fig. 38: Detail: removing the fan slide-in module.....	37
Fig. 39: Detail: Fan compartment (without fan slide-in module).....	37
Fig. 40: Fan slide-in module without filtermat holder.....	38
Fig. 41:Rear view of the fan slide-in module.....	38
Fig. 42: Fan slide-in module with mounted filter mat holder.....	38
Fig. 43: Side view of the fan slide-in module.....	38
Fig. 44: Detail with filter mat holder on the fron side of the KISS 2U V2 platform.....	39
Fig. 45: Detail without filter mat holder on the front side.....	40
Fig. 46: Filter mat holder without filter mat.....	40

Fig. 47: Filtermatholder with filter mat.....40

Fig. 48: Filter mat40

Fig. 49: Attached inner part of the slide rail (shown left side view of the KISS 2U V2 system)42

Fig. 50: KISS 2U V2 platform with slide rail in pulled-out position42

Fig. 51: KISS 2U V2 platform with slide rail in pushed-in position42

2. Introduction

Kontron Europe GmbH would like to point out that the information contained in this manual may be subject to technical alteration, particularly as a result of the constant upgrading of Kontron Europe products. The attached documentation does not entail any guarantee on the part of Kontron Europe with respect to technical processes described in the manual or any product characteristics set out in the manual. Kontron Europe does not accept any liability for any printing errors or other inaccuracies in the manual unless it can be proven that Kontron Europe is aware of such errors or inaccuracies or that Kontron Europe is unaware of these as a result of gross negligence and Kontron Europe has failed to eliminate these errors or inaccuracies for this reason. Kontron Europe expressly informs the user that this manual only contains a general description of technical processes and instructions which may not be applicable in every individual case. In cases of doubt, please contact Kontron Europe.





This manual is protected by copyright. All rights are reserved by Kontron Europe. Copies of all or part of this manual or translations into a different language may only be made with the prior written consent of Kontron Europe. Kontron Europe points out that the information contained in this manual is constantly being updated in line with the technical alterations and improvements made by Kontron Europe to the products and thus this manual only reflects the technical status of the products by Kontron Europe at the time of printing.

© 2012 by Kontron Europe GmbH

Printing and duplication, even of sections, is only permissible with the express approval of

Kontron Europe GmbH
Site: Eching
Oskar-von-Miller-Str. 1
85386 Eching
Germany

2.1. Symbols used in this Manual

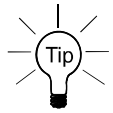
Symbol	Meaning
	This symbol indicates the danger of injury to the user or the risk of damage to the product if the corresponding warning notices are not observed.
	This symbol indicates that the product or parts thereof may be damaged if the corresponding warning notices are not observed.
	This symbol indicates general information about the product and the user manual.
	This symbol indicates detail information about the specific product configuration.
	This symbol precedes helpful hints and tips for daily use.

3. Important Instructions

This manual provides important information required for the proper operation of the KISS 2U V2 platform!

This chapter contains instructions which must be observed when working with the KISS 2U V2 platform.

3.1. Warranty Note

Due to their limited service life, parts which by their nature are subject to a particularly high degree of wear (wearing parts) are excluded from the warranty beyond that provided by law. This applies to batteries, for example.

3.2. Exclusion of Accident Liability Obligation

Kontron Europe shall be exempted from the statutory accident liability obligation if the user fails to observe the included document: "General Safety Instructions for IT Equipment" the hints in this manual or eventually the warning signs label on the device.

3.3. Liability Limitation / Exemption from the Warranty Obligation

In the event of damage to the device caused by failure to observe the included document "General Safety Instructions for IT Equipment", the hints in this manual or eventually the warning signs label on the device, Kontron Europe shall not be required to honor the warranty even during the warranty period and shall be exempted from the statutory accident liability obligation.

4. Safety Instructions



Please consider the instructions described in the included “General Safety Instructions for IT Equipment”.

Caution:

Energy hazards > 240 VA are present inside the chassis!

Activities such as system expansion with expansion cards, or maintenance have to be carried-out by qualified personnel familiar with the associated dangers!

The installation instructions for the KISS 2U V2 Platform is the responsibility of the distributor.

When used as intended the KISS 2U V2 platform is to operate only closed and locked.

Only when the cover is properly installed, secured with the knurled screws on the rear and the cover fastening screw on the front, and the access panel is locked with the key, it is ensured that the user doesn't have access to the internal parts of the KISS 2U V2 platform, loaded with hazardous energy.

4.1. Operation of Laser Source Devices

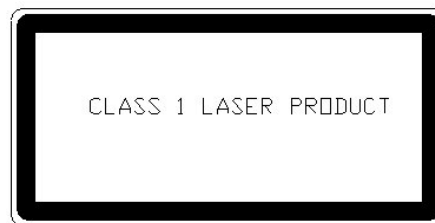

Fig. 1: Laser radiation warning label

The optional CD ROM and DVD drives contain light-emitting diodes (classified in accordance with IEC 825-1:1993: LASER CLASS 1) and therefore must not be opened.

If the enclosure of such a drive is opened, invisible laser radiation is emitted. Do not allow yourself to be exposed to this radiation.

The laser system meets the code of Federal Regulations 21 CFR, 1040 for the USA and the Canadian Radiation Emitting Devices Act, REDR C 1370.



4.2. Electrostatic Discharge (ESD)

A sudden discharge of electrostatic electricity can destroy static-sensitive devices or micro-circuitry. Proper packaging and grounding techniques are necessary precautions to prevent damage. Always take the following precautions:

1. Transport boards in static-safe containers such as boxes or bags.
2. Keep electrostatic sensitive parts in their containers until they arrive at the ESD-safe workplace.
3. Always be properly grounded when touching a sensitive board, component, or assembly.
4. Store electrostatic-sensitive boards in protective packaging or on antistatic mats.

4.2.1. Grounding Methods

The following measures help to avoid electrostatic damages to the device:

1. Cover workstations with approved antistatic material. Always wear a wrist strap connected to workplace as well as properly grounded tools and equipment.
2. Use anti-static mats, heel straps, or air ionizers to give added protection.
3. Always handle electrostatic sensitive components by their edge or by their casing.
4. Avoid contact with pins, leads, or circuitry.
5. Turn off power and input signals before inserting and removing connectors or connecting test equipment.
6. Keep work area free of non-conductive materials such as ordinary plastic assembly aids and styrofoam.
7. Use field service tools such as cutters, screwdrivers, and vacuum cleaners which are conductive.
8. Always place drives and boards PCB-assembly-side down on the foam.

4.3. Instructions for the Lithium Battery

The installed CPU board is equipped with a Lithium battery. When replacing the lithium battery, please follow the corresponding instructions in the section 10.3 "Replacing the Lithium Battery".



Caution

Danger of explosion when replacing with wrong type of battery. Replace only with the same or equivalent type recommended by the manufacturer. The lithium battery type must be UL recognized.



Do not dispose of lithium batteries in general trash collection. Dispose of the battery according to the local regulations dealing with the disposal of these special materials, (e.g. to the collecting points for dispose of batteries).

5. Electromagnetic Compatibility (Class A Device)

5.1. Electromagnetic Compatibility (EU)

This product is intended only for use in industrial areas. The most recent version of the EMC guidelines (EMC Directive 2004/108/EC) and/or the German EMC laws apply. If the user modifies and/or adds to the equipment (e.g. installation of add-on cards) the prerequisites for the CE conformity declaration (safety requirements) may no longer apply.

Warning!

This is a class A product. In domestic environment this product may cause radio interference in which case the user may be required to take adequate measures.

5.2. FCC Statement (USA)

This equipment has been tested and found to comply with the limits for a Class A digital device, pursuant to Part 15 of the FCC Rules. These limits are designed to provide reasonable protection against harmful interference when the equipment is operated in commercial environment. This equipment generates, uses, and can radiate radio frequency energy and, if not installed and used in accordance with the instruction manual, may cause harmful interference to radio communications. Operation of this equipment in residential area is likely to cause harmful interference in which case the user will be required to correct the interference at his own expense.

5.3. EMC Compliance (Canada)

The method of compliance is self-declaration to Canadian standard ICES-003:

(English): This Class A digital apparatus complies with the Canadian ICES-003.

(French): Cet appareil numérique de la class A est conforme à la norme NMB-003 du Canada.

6. Scope of Delivery

- KISS 2U V2 platform (system configuration ordered)
- 2x key for the front access panel lock
- 1x Ferrite core (for DC system configuration)
- 1x AC power cable (for AC system configuration)
- 2x AC power cable (for AC system configuration with redundant PSU)
- Rubber feet (self-adhesive)
- Instruction for attaching the ferrite core
- General Safety Instruction for IT Equipment

Optional Parts

- Slide Rails (PN: 1016-5807)
- Rack Slide Rails Kit for KISS 1U and KISS 2U/4U V2 (PN: 1051-7200)

6.1. Type Label and Product Identification

The type label (product designation, serial number) and the inspection status label of your KISS 2U V2 platform are located on the right side of the device.

System Type	Product Name	Product Identification
KISS 2U V2	KISS 2U V2 xxxxxxxx-y	<p>KISS 2U V2 = System Type</p> <p>The "xxxxxxx" group is replaced by up to a max. 8-digit combination of numbers, letter or space, and represents the installed CPU board</p> <p>The "y" is replaced by a single letter (A through Z) representing the power supply installed into the system.</p>

Note:

- A:** corresponds to the systems with a wide range AC power supply
- B:** corresponds to the systems with a redundant wide range AC power supply
- C:** corresponds to the system configuration with +24 VDC power supply
- D:** corresponds to the system configuration with -48 VDC power supply

7. Product Description

The KISS 2U V2 platform expands the Kontron KISS computer line. KISS 2U V2 is a scalable 2U (19") platform, equipped with a motherboard or a SBC (Single Board Computer) board, supporting various system configurations (refer to "KISS 2U V2 Systems - Configuration Guides" on our website). The flexible customer-specific hardware system configuration and the robust construction with excellent mechanical stability of the KISS 2U V2 platform offer the superior qualities of a computer designed for operation in harsh industrial environment.

The KISS 2U V2 platform is designed to be installed in 19" racks. It may be also installed as a desktop unit.

Versions of the KISS 2U V2 platform:



The system can be equipped with up to two drive bays (depending on the system configuration):

- L1:** one 5:25" front accessible drive bay
- L2:** one 3.5" internal drive bay or an front accessible slim drive



For customized versions and system configurations, please observe the corresponding "KISS 2U V2 System - Configuration Guides" for KISS 2U V2 on our web site www.kontron.com.

The device can be fitted with an AC wide range, an AC redundant, a +24VDC or a -48VDC power supply (depending on the system configuration ordered).

The controls of the KISS 2U V2 platform are located behind the front access panel and consist, as standard, of a power button, a power and HDD LED.

Two system fans are installed at the front side of the unit. These are attached to the system by a fan slide-in module. The fan slide-in module simplifies the installation and removal of these components, even during operation.

The washable filter mat, which protects your system against dust and dirt, is located on the front side of the system. This filter mat can be replaced during operation.

Depending on the integrated CPU board [motherboard or SBC (Single Board Computer)] your system can be expanded with different expansion cards.

The type label is located on the right hand side of the device.



Fig. 6: KISS 2U V2 platform



The KISS 2U V2 platform may be operated in horizontal as well as in vertical position.

When powering on the KISS 2U V2 platform, make sure that the air intake and exhaust openings are not obstructed by objects.

7.1. Front Side

The KISS 2U V2 platform is available as a rackmount version.

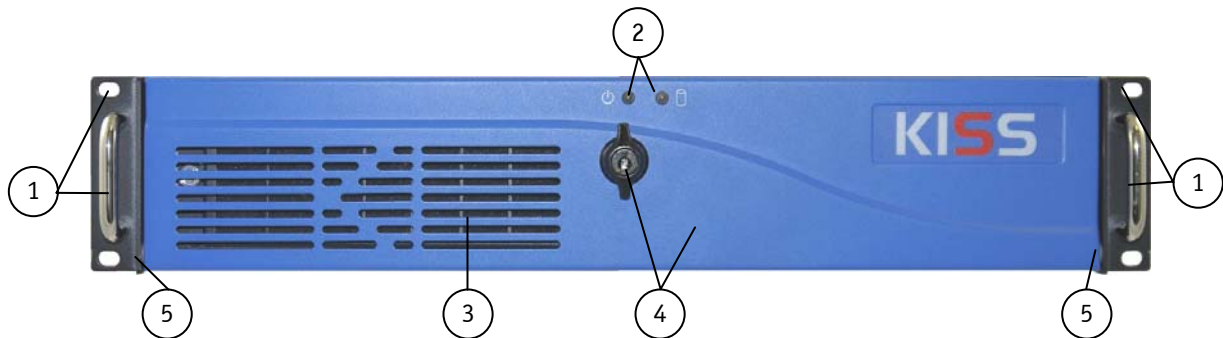

Fig. 7: Front (rackmount version) with the front access panel closed

- | | |
|--|--|
| 1 19" bracket with handle | 3 Ventilation grille on the front access panel |
| 2 Light diffusers for HDD and power LEDs | 4 Front access panel with a locking mechanism |
| | 5 Plastic washer |

You can easily convert your system to a desktop version. Unscrew the left and right hand 19" brackets from the device. To attach the rubber feet (included), please follow the instructions in the section 8.1 "Attaching the Rubber Feet".

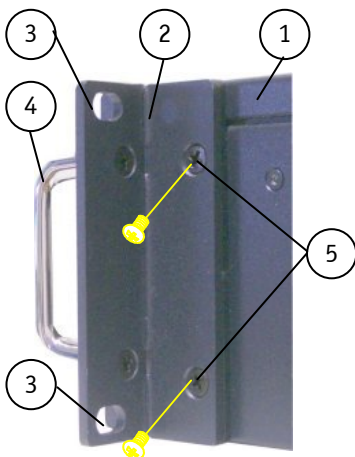

Fig. 8: 19" bracket with fixing screws

- | |
|--|
| 1 KISS 2U V2 platform chassis |
| 2 19" bracket with handle |
| 3 Holes for rack mounting |
| 4 Handle |
| 5 Screws for attaching the 19" bracket |

The Power button, the USB ports and the integrated 5.25" drive are located on the front side (Fig. 9) of the KISS 2U V2 platform, behind the front access panel.

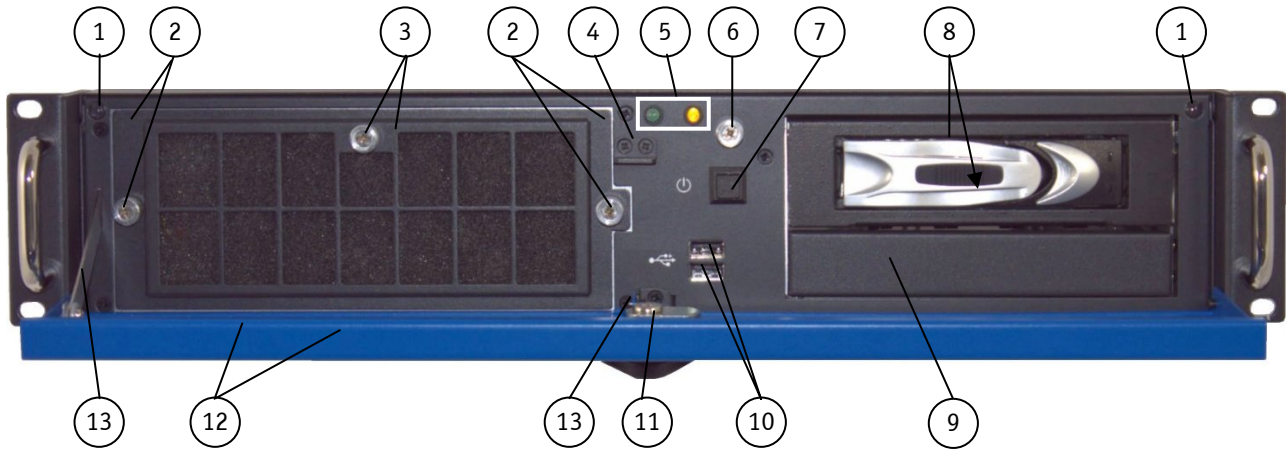

Fig. 9: Front (rackmount version) with the front access panel open

- | | |
|---|--|
| 1 Bump stop for the front access panel | 8 L1: 1x 5.25" externally accessible drive bay (shown with 1x 3.5" removable HDD) |
| 2 Fan slide-in module with knurled screws | 9 L2: 1x internal 3.5" drive bay or 1x external accessible slim drive |
| 3 Filter mat holder with fixing screw | 10 2x USB (2.0) ports |
| 4 Slot for the locking mechanism | 11 Locking mechanism |
| 5 Indicators (power and HDD LED) | 12 Front access panel with ventilation grille |
| 6 Cover fastening screw on the front side | 13 Holders for the front access panel |
| 7 Power button | |

7.1.1. Power Button



Fig. 10: Power button on the front

The power button (refer to Fig. 10, and Fig. 9, pos. 7) is located at the front side of the platform, behind the front access panel and allows to power ON/OFF the system. Please observe the settings option for "Restore on AC Power Loss" in the BIOS Setup.

Setting options: Power On/Power Off/Last State.



Warning!

Turning the power off using the power button (refer to Fig. 9, pos. 7) does not disconnect the KISS 2U V2 platform from the AC/DC power source.

For system configuration with:

AC wide range PSU: Please observe that the ON/OFF switch of this PSU (see Fig. 27) does not disconnect the KISS 2U V2 from the AC power source. Even you turn off the system using the power button (Fig. 9, pos. 7), and the ON/OFF switch of this PSU, there is still a standby-voltage of 5 Vsb on the motherboard or SBC (refer also to the hint in the subsection 7.2.4).

AC wide range and AC redundant PSU: The unit is completely disconnected from the mains, only when the power cord is disconnected either from the mains or the unit. Therefore, the power cord and its connectors must always remain easily accessible.

+24VDC-bzw. -48VDC-Netzteil: The ON/OFF switch of the DC power supplies (Fig. 23 and Fig. 24) does not disconnect the KISS 2U V2 platform from the DC power source.

7.1.2. LED Indicators

The LED indicators (refer to Fig. 9, pos. 5 and Fig. 11) of the KISS 2U V2 are located at the front of the device, behind the front access panel.

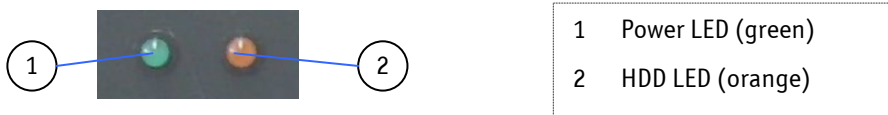



Fig. 11: LED indicators

Power LED (green)	This LED (Fig. 11. pos. 1) is green when the system is switched on using the Power On/Off button. Requirement: The system must be connected to the corresponding power source, using the power cable. The power supply ON/OFF switch (if available), on the rear of the system must be set to “ON”.
HDD LED (orange)	This LED (Fig. 11. pos. 2) is orange when the hard disk is accessed.
	Do not press the eject button, while the drive LED is lit or flashing.

7.1.3. Ports on the Front Side

7.1.3.1. USB Ports

KISS 2U V2 is equipped with two USB (2.0) ports on the front (Fig. 9, pos. 10 and Fig. 12). You can connect various USB devices to these two USB 2.0 interface connectors.



Fig. 12: USB ports on the front side

7.1.4. Front Access Panel

The securing lock mechanism (Fig. 7, pos. 4) located at the access panel allows you, if required, to protect your system from unauthorized use. When the access panel is locked, the cover of the KISS 2U V2 system can not be removed, and the drives, filter mat holder and power button are not accessible.



If USB devices are connected to the USB ports on the front of the device, the front access panel can not be closed and locked.

The key should be kept somewhere where it is not accessible to unauthorized persons.

7.1.5. Cover fastening screw on the front side

The cover fastening screw (Fig. 9, pos. 6) secures the cover to the chassis on the front side.



To remove the cover of the KISS 2U V2 platform, the following knurled screws have to be loosened:

- The cover fastening screw (Fig. 9, pos. 6) on the front side
- The knurled screws (Fig. 13/ Fig. 15 pos. 3 and Fig. 19, pos. 6) on the rear side.

The chassis of the KISS 2U V2 platform is properly closed only if the cover is attached and the above mentioned screws are fastened.

7.1.6. Filter Mat and Filter Mat Holder

The filter mat and the filter mat holder (Fig. 9, pos. 3) are located behind the air grilles of the front access door (Fig. 7, pos. 3). The filter mat holder is fastened to the fan slide-in module (Fig. 46, pos. 4) by a knurled screw (Fig. 46, pos. 5). The filter mat is inserted in the filter mat holder (Fig. 42). This filter mat protects your system against dust and dirt (see section 10.2 "Cleaning the Filter Mat").

7.1.7. Fan Slide-in Module

The two system fans are integrated in a user-friendly, replaceable fan slide-in module (hot-swap) (see subsection 7.2.6 "Fan Slide-In Module and Temperature Sensor"). The fan slide-in module (Fig. 9, pos. 2) can be replaced during operation (see section 10.1 "Replacing System Fans").

7.1.8. Drive Bays

Depending on the ordered system configuration, your KISS 2U V2 can be equipped with up to two drive bays (see (Fig. 9, pos. 8 and 9; configuration with an internal HDD):

Drive Bay	Description (refer to Fig. 9)
L1	<input type="checkbox"/> one externally accessible 5.25" drive bay (shown with 1x 3.5" removable HDD installed)
L2	<input type="checkbox"/> one internal 3.5" drive bay for a SATA HDD (shown with an internal, not externally accessible HDD installed) or <input type="checkbox"/> a front accessible 5.25" slim-line drive bay or <input type="checkbox"/> a CF Reader



For KISS 2U V2 system configurations with a disk subsystem KISS DA 235CF, the drive bays L1 and L2 are occupied by this subsystem with removable HDDs.

For customer-specific versions and system configurations, please refer to the corresponding "KISS 2U V2 Systems - Configuration Guides" on our website www.kontron.com.

The KISS Hot Swap disk subsystems allow replacing of the SATA HDDs during operation.

7.2. Rear Side

On the rear side, depending on the ordered KISS 2U V2 platform configuration, are available the external interfaces of the integrated motherboard or SBC card, the additional interfaces, the power supply unit and the air exhaust openings.



The order or the number of the KISS 2U V2 platform interfaces can be different depending on the device configuration.

7.2.1. System Configurations with SBC Cards

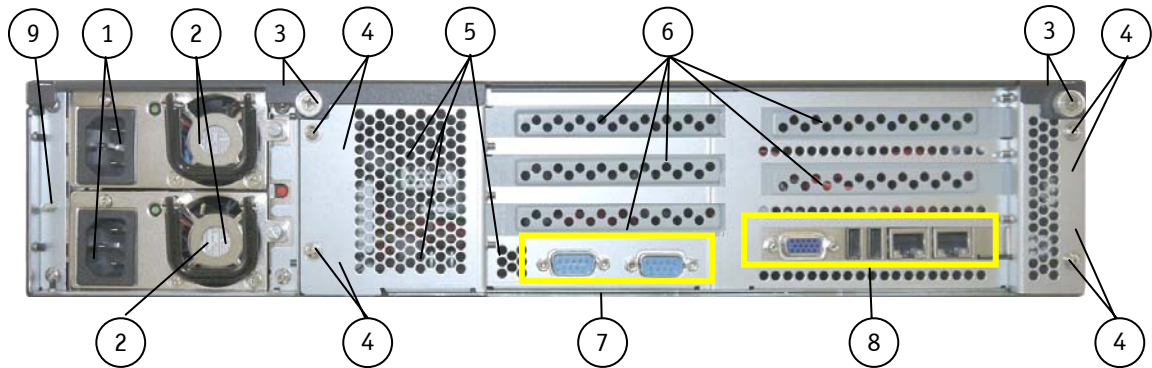

Fig. 13: Rear side of the KISS 2U V2 with an SBC card (shown with a PCI-760 and a redundant PSU)

Legend for Fig. 13 and Fig. 14:

- | | |
|--|---|
| 1 AC inlet connector | 5 Air exhaust openings |
| 2 Fans of the redundant PSU | 6 Free slots for expansion cards |
| 3 Rear side of the cover with captive knurled screws | 7 Onboard interfaces routed to the rear side |
| 4 Card cage (for SBC and expansion cards) with fixing screws | 8 Interfaces of the SBC card
[PCI-760 (Fig. 13) / PCI-761 (Fig. 14)] |
| | 9 Ground stud |

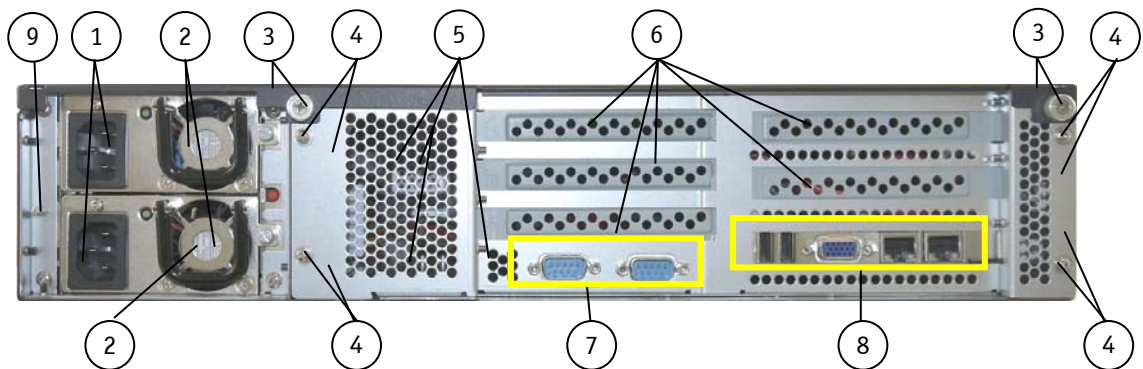

Fig. 14: Rear side of the KISS 2U V2 with an SBC card (shown with a PCI-761 and a redundant PSU)

7.2.1.1. External Ports of the SBC Cards



A detailed ports description can be found in the manual for the PCI-760 or PCI-761 SBC board. You can download the corresponding manual from our web site www.kontron.com by selecting the product.

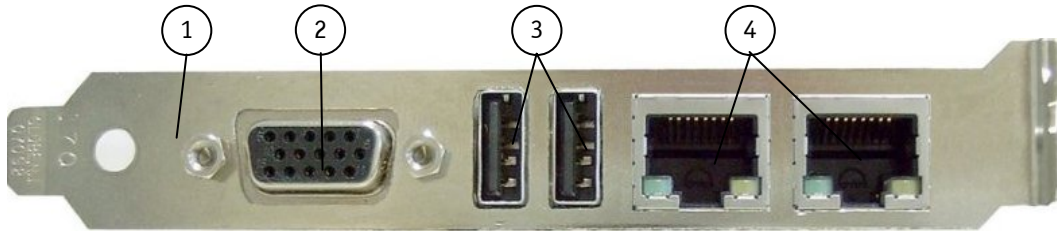

Fig. 15: External ports of PCI-760 SBC card

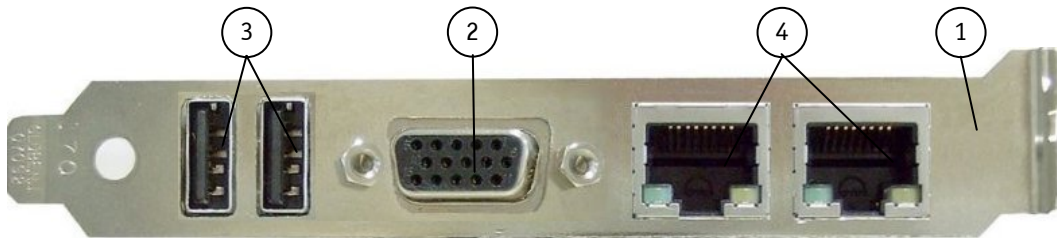

Fig. 16: External ports of PCI-761 SBC card

Legend for Fig. 15 and Fig. 17:

- | | | | |
|---|------------------------------|---|-----------------------------------|
| 1 | PCI-760/PCI-761 slot bracket | 3 | 2x USB (2.0) ports |
| 2 | VGA port | 4 | 2x LAN ports with integrated LEDs |

7.2.2. System Configuration with Motherboard

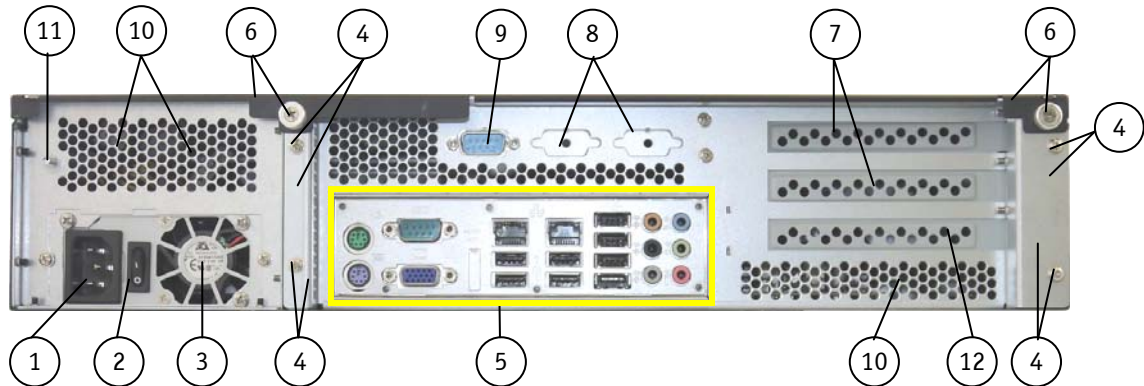

Fig. 17: Rear side of the KISS 2U V2 with a KTQ45/Flex (here with a wide range power supply)

- | | |
|--|--|
| 1 AC inlet connector | 7 Slot brackets for expansion cards |
| 2 On/Off power switch of the PSU | 8 Cut-outs for optional (customer-specific) interfaces routed to the rear (9-pin D-SUB type) |
| 3 Fan of the Power Supply Unit (PSU) | 9 Additional serial port (RS232) |
| 4 Card cage (for motherboard and expansion cards) with fixing screws | 10 Air exhaust openings |
| 5 External interfaces of the KTQ45/Flex motherboard | 11 Ground stud |
| 6 Rear side of the cover with captive knurled screws | 12 Mechanical slot |

7.2.3. System Configuration with Motherboard and Low Profile Cards

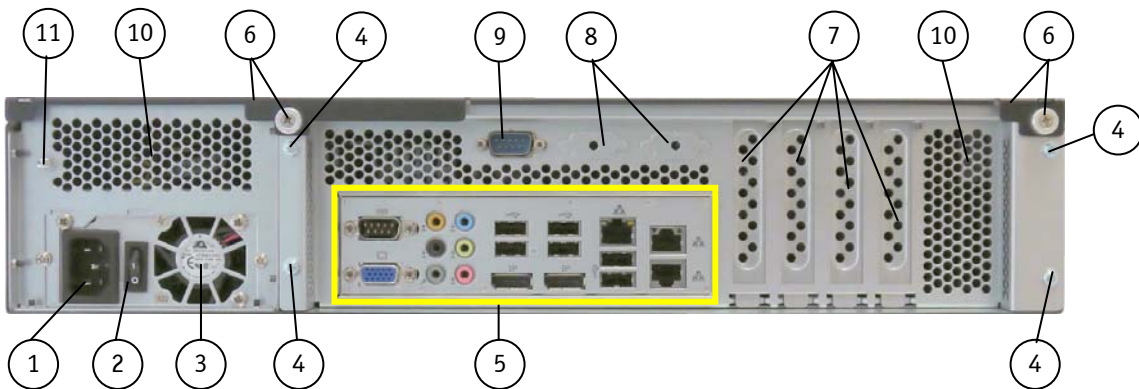

Fig. 18: Rear side of the KISS 2U V2 with a KTQ67/Flex (shown as a configuration for low profile expansion cards)

- | | |
|--|--|
| 1 AC inlet connector | 6 Rear side of the cover with captive knurled screws |
| 2 On/Off power switch of the PSU (only for wide range PSU) | 7 Slot brackets for expansion cards |
| 3 Fan of the Power Supply Unit (PSU) | 8 Cut-outs for optional (customer-specific) interfaces routed to the rear (9-pin D-SUB type) |
| 4 Card cage (for motherboard and expansion cards) with fixing screws | 9 Additional serial ports (RS232) |
| 5 External interfaces of the KTQ67/Flex motherboard | 10 Air exhaust openings |
| | 11 Ground stud |

7.2.3.1. External Interfaces of the KTQ45/Flex Motherboard



A detailed ports description can be found in the manual of the installed motherboard. You can download the corresponding manual from our web site www.kontron.com by selecting the product.

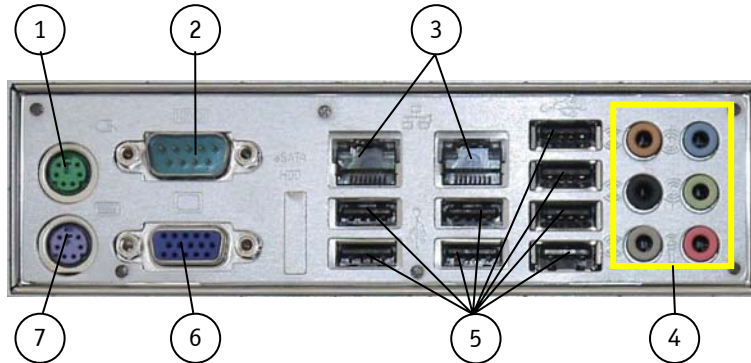

Fig. 19: External ports of the KTQ45/Flex motherboard

- | | |
|---|--------------------------|
| 1 PS/2 mouse port (green) | 4 Audio connectors (6.1) |
| 2 Serial port (RS232) | 5 6x USB(2.0) ports |
| 3 2x Ethernet ports (RJ45),
(10/100/1000 Mbps) | 6 VGA port |
| 7 PS/2 keyboard port (purple) | |

7.2.3.2. External Interfaces of the KTQ67/Flex Motherboard



A detailed ports description can be found in the manual of the installed motherboard. You can download the corresponding manual from our web site www.kontron.com by selecting the product.

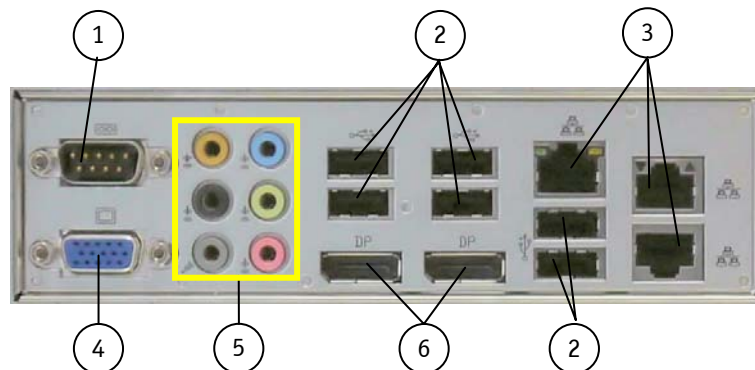

Fig. 20: External ports of the KTQ67/Flex motherboard

- | | |
|--|--------------------------|
| 1 Serial port (RS232) | 4 VGA port |
| 2 6x USB (2.0) ports | 5 Audio connectors (6.1) |
| 3 3x Ethernetport (RJ45),
(10/100/1000Mbps) | 6 Display Port (DP) |

7.2.3.3. Additional Ports

Depending on the installed CPU card (motherboard or SBC), your system can be equipped with on-board interfaces (e.g. serial interface) routed to the rear panel (refer to Fig. 14, pos. 7 and Fig. 17, pos. 9). These ports allow you to connect different peripherals.



Information and technical data can be found in the corresponding board manual of the installed motherboard or SBC card.

You can download the relevant board manual for your system configuration from our web site at www.kontron.com by selecting the product name.

Refer also to the "KISS 2U V2 Systems - Configuration Guides" on our web site.

7.2.4. Power Supply Version and ON/OFF Switch of the PSU

The power supply is located on the rear side of the KISS 2U V2 platform.

On request, the KISS 2U V2 platform can optionally be equipped with either an AC wide range or an AC redundant wide range, a +24VDC or a -48VDC power supply unit. The respective power supply version and the corresponding nominal voltage range can be found on the type label on the right side of the system.

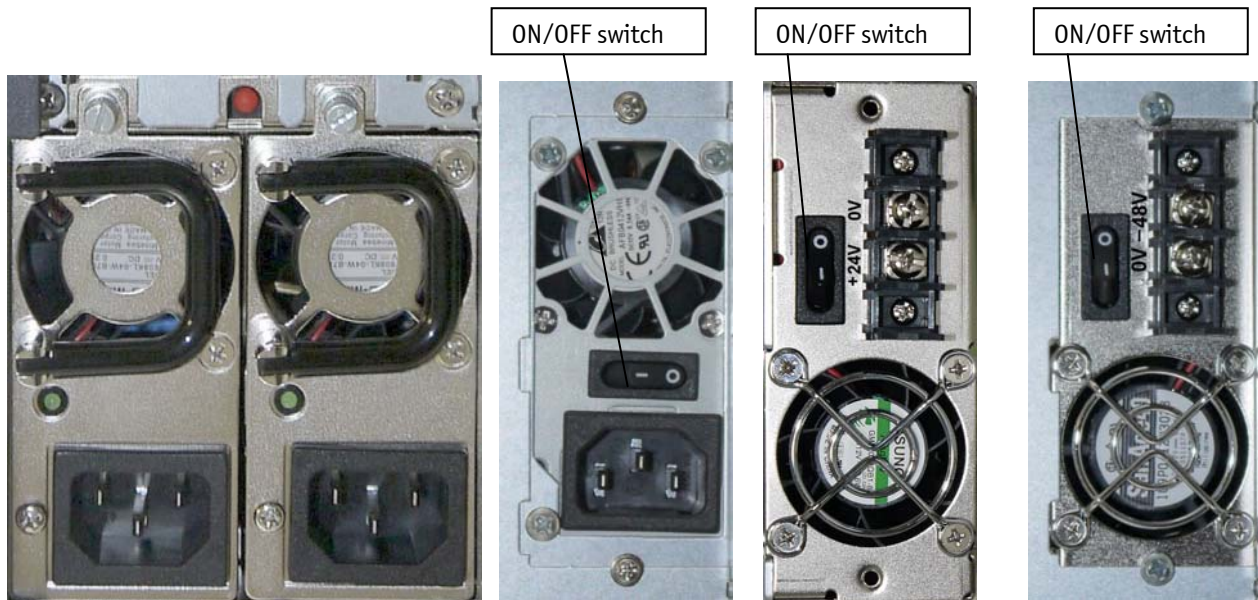

Fig. 21: Detail: AC redundant Wide Rang PSU

Fig. 22: Detail:
AC Wide Rang PSU

Fig. 23: Detail:
+24VDC PSU

Fig. 24: Detail:
-48VDC PSU



After attaching the cables to the terminals of the DC power supplies, always operate the KISS 2U V2 systems with the protective cover available.

Please observe that the ON/OFF switch of the AC wide range PSU (Fig. 22) does not disconnect the KISS 2U V2 platform from the main power source. Even you turn off the system using the power button (Fig. 9, pos. 7) or the ON/OFF switch of this PSU, there is still a standby-voltage of 5 VSb on the motherboard or SBC.



Hint for the ON/OFF switch of the AC Wide Range PSU (Fig. 22) for KISS 2U V2 PCI760-A only:

This switch is factory-set to "ON" and secured in this position by a bracket.

Don't switch OFF the PSU ON/OFF switch (Fig. 22) during operation. Please observe the hint on the attached label. Don't remove this label.

7.2.5. Grounding Stud

The grounding stud is located on the rear side of the KISS 2U V2 platform (see Fig. 13, pos. 9 and Fig. 14, pos. 11).



The KISS 2U V2 systems with grounding studs marked with a PE symbol (Fig. 25) have to be grounded by establishing a large-area contact between the grounding stud and an appropriate grounding connection point.



Fig. 25: Grounding stud marked with PE symbol



Fig. 26: Unmarked grounding stud

7.2.6. Fan Slide-In Module and Temperature Sensor

The three system fans are securely installed in a user-friendly, interchangeable fan-slide-in module (Hot-Swap). The fan slide-in module is mounted in the fan compartment on the front of the device.

The systems fans are temperature-controlled via the temperature sensors which are built in the system. Thus sufficient airflow is ensured for an optimal, active cooling of the system.



The operation of the KISS 2U V2 platform is permitted only with a functional fan slide-in module (refer to the "Replacing System Fans" section).

Defective components may be replaced only by Kontron original spare parts.

❑ part number of the fan slide-in module: 1050-8442

7.3. Side View

On the left and right sides of the device, there are six M4 threaded screw holes, for installing the KISS 2U V2 platform in a 19" industrial cabinet using slide rails [not included; refer also to the chapter 11 "Slide Rails (Option)".]

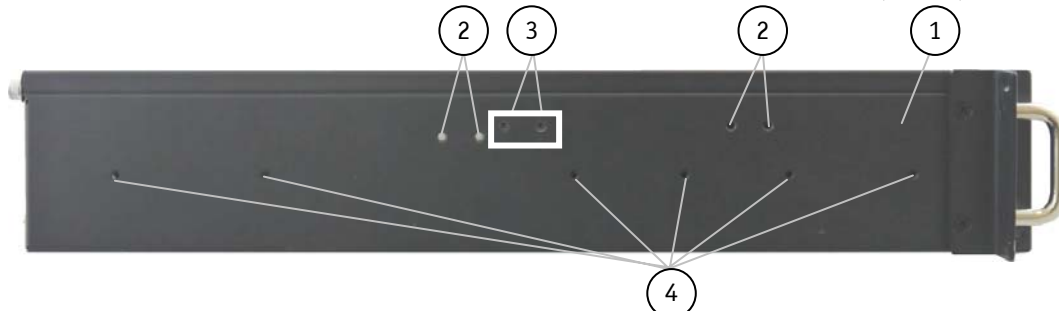

Fig. 27: KISS 2U V2 - side view

- | | | | |
|---|---|---|---|
| 1 | Side view of the KISS 2U V2 platform | 3 | Fastening screws for the card holder (the position can be different ; see pos. 2) |
| 2 | 3x two M3 threaded screw holes used for mounting of card holder | 4 | 4x M4 threaded screw holes (on both sides) |

7.4. Installed Motherboard / SBC Card

Depending on the KISS 2U V2 platform configuration ordered, your system may be equipped with a motherboard or an SBC card (Single Board Computer).



For KISS 2U V2 versions and system configurations, please refer to the corresponding “KISS 2U V2 Systems - Configuration Guides” on our website www.kontron.com. More information and technical data can be found in the corresponding board manual (motherboard or SBC, depending on the system configuration ordered). You can download the manual from our web site at www.kontron.com by selecting the product.

7.5. System Configurations with SBC

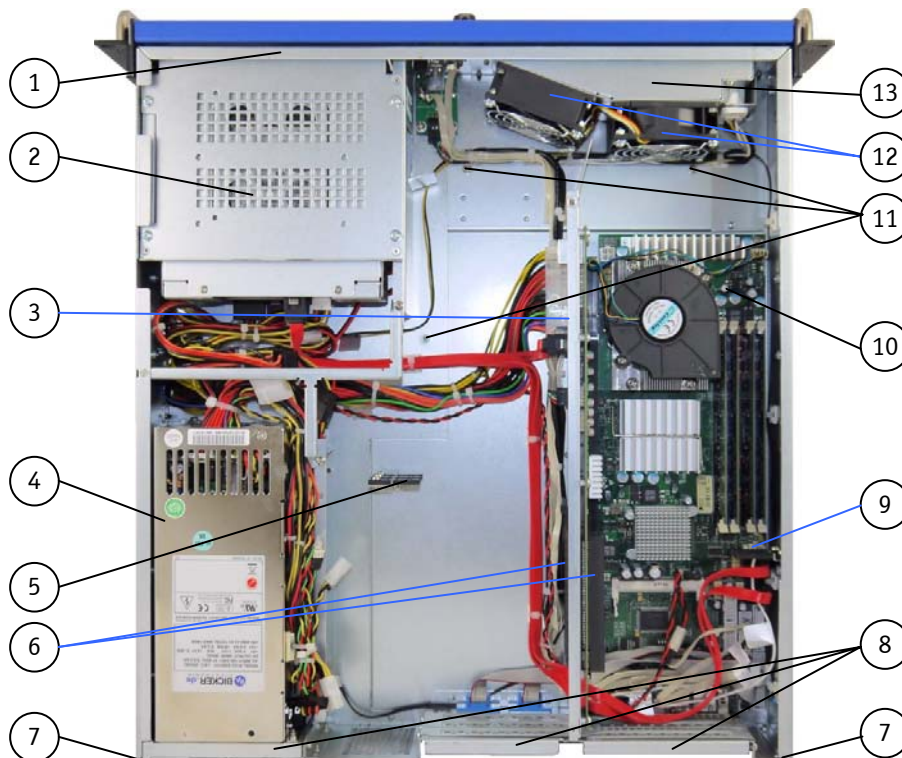

Fig. 28: KISS 2U V2 Configuration with PCI 760-SBC (Single Board Computer)

- | | |
|---|--|
| 1 Cover retaining plate on the front side | 8 Cover retaining plates on the rear side |
| 2 L1 and L2 : drives bays (stacked one above the other into a drive cage) | 9 Card hold down bracket (adjustable for long or short expansion cards; see Fig. 27, pos. 3) |
| 3 Retaining bracket for the butterfly-backplane (not provided at system configuration with low profile cards) | 10 SBC card |
| 4 Power Supply Unit (PSU) | 11 Fastening screws for the card cage (expansion cards) |
| 5 Card holder | 12 Fans (of the fan slide-in-module) |
| 6 Butterfly-backplane for SBC cards | 13 Fan slide-in-module with two fans |
| 7 Centring latches for the cover at the rear side | |

7.6. System Configuration with Motherboard

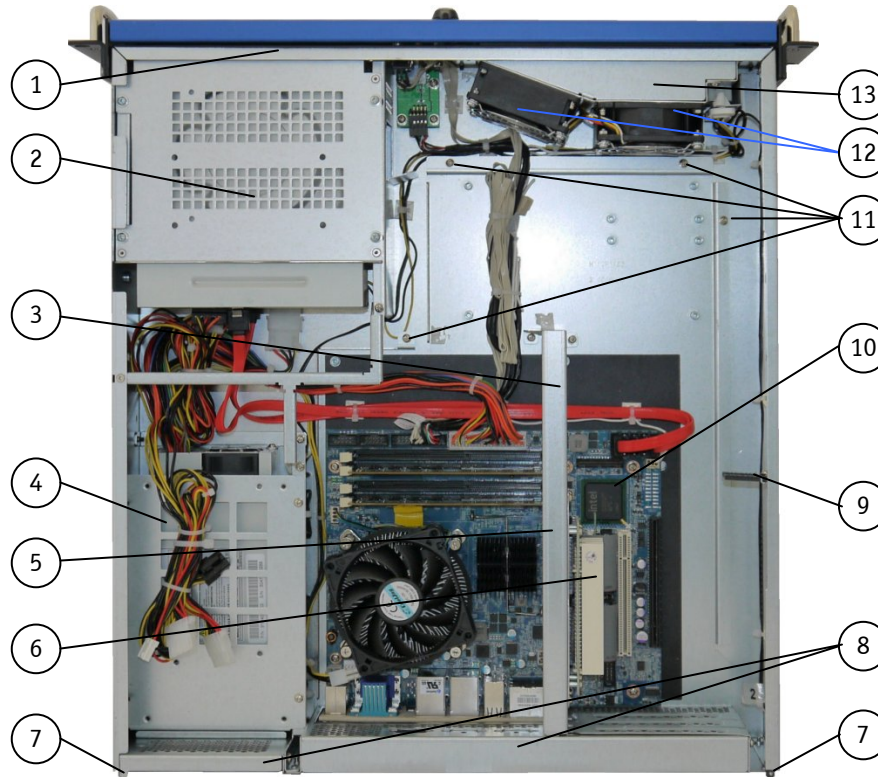

Fig. 29: KISS 2U V2 - Configuration with KTQ45/Flex motherboard

- | | | | |
|---|---|----|--|
| 1 | Cover retaining plate on the front side | 7 | Centring latches for the cover at the rear side |
| 2 | L1 and L2 : drives bays (stacked one above the other into a drive cage) | 8 | Cover retaining plate on the rear side |
| 3 | Retaining bracket for the butterfly-backplane (not provided at system configuration with low profile cards) | 9 | Card hold down bracket (adjustable for long or short expansion cards; see Fig. 27, pos. 3) |
| 4 | Power Supply Unit (PSU) | 10 | Motherboard |
| 5 | Retaining bracket for the riser card (not provided at system configuration with low profile cards) | 11 | Cage for motherboard and expansion cards |
| 6 | Riser card for expansion cards | 12 | Fans (of the fan slide-in-module) |
| | | 13 | Fan slide-in-module with two fans |

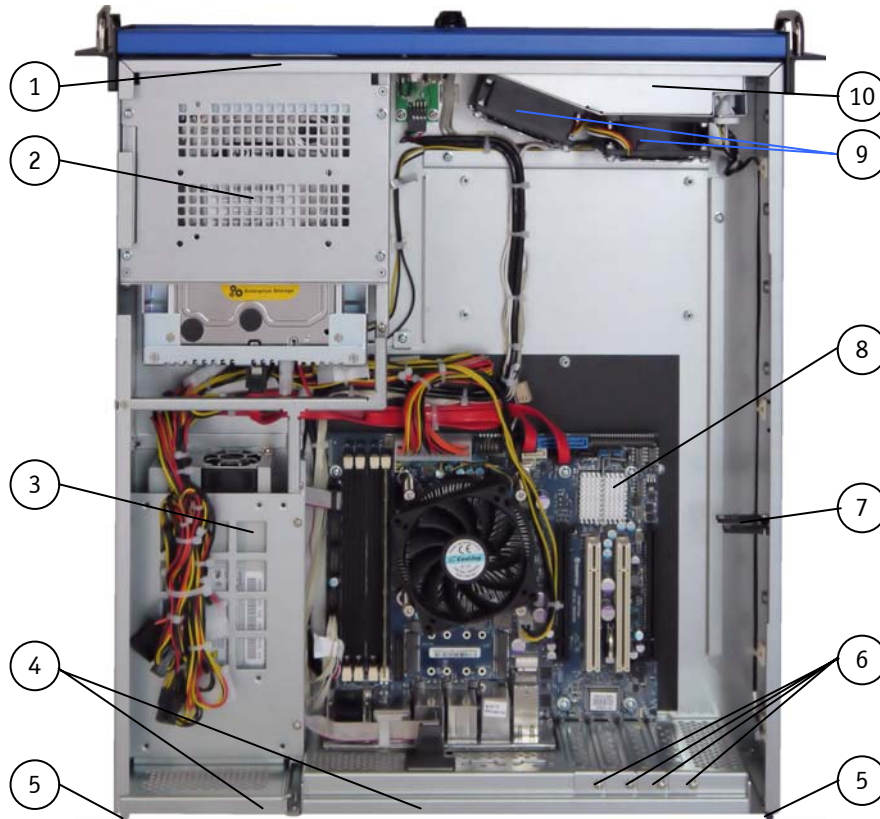

Fig. 30: KISS 2U V2 - Configuration with KTQ67/Flex motherboard (shown as a config. for low-profile expansion cards)

- | | | | |
|---|---|----|--|
| 1 | Cover retaining plate on the front side | 6 | Fastening screws for the slot brackets or expansion card slot brackets |
| 2 | L1 and L2 : drives bays (stacked one above the other into a drive cage) | 7 | Card hold down bracket (adjustable for long or short expansion cards; see Fig. 27, pos. 3) |
| 3 | Power Supply Unit (PSU) | 8 | Motherboard |
| 4 | Cover retaining plates on the rear side | 9 | Fans (of the fan slide-in-module) |
| 5 | Centring latches for the cover at the rear side | 10 | Fan slide-in-module with two fans |

7.6.1. Riser Card and/or Backplane and available Bays

Depending on the KISS 2U V2 hardware configuration ordered, you can expand your system with full size and/or half size or low-profile additional cards.

System	Installed Board	Riser Card /Backplane	Available Slots for Exoansion Cards
KISS-2U V2	Desktop Motherboard	Riser card 1	2x PCI, 32 Bit @ 33 MHz, full size
		Riser card 2	1x PCI, 32 Bit @ 33 MHz, full size 1x PCIe x16, full size
		Riser card 3	1x PCIe x16 full size 1x PCIe x4 full size
		without riser card	1x PCIe x16 (for low-profile cards only) 1x PCIe x4 (for low-profile cards only) 2x PCI, 32 Bit @ 33 MHz, (for low-profile cards only)
	Server Motherboard	without riser card	4x PCIe x8 (for low-profile cards only)
	SBC	Backplane 1	3x PCI, 32 Bit @33 MHz (1. side) 1x PCIe x16 (2. Side) 1x PCIe x4 (2. Side)
		Backplane 2	2x PCIe x4 (1. Side) 1x PCIe x4 (2. Side) 1x PCIe x16 (2. Side) 1x PCIe x8 (2. Side)

8. Installation and Removal

8.1. Attaching the Rubber Feet

If the system is to be used as a desktop version, the rubber feet supplied with the device can be attached to it.

To attach the rubber feet, proceed as follows:



Before attaching the rubber feet, ensure that your system is switched off and disconnected from the main power source.

Ensure that all components are securely installed and that the device cover has been screwed on tightly.

1. Turn the device upside down on a table or desk.
2. Remove the protective film from the rubber feet.
3. Stick the four rubber feet to the underside of the device.

8.2. Cover

The cover will be fixed to the chassis using two fixing brackets at the front side of the cover (Fig. 31, pos.3 and pos. 4), two fixing brackets with captive knurled screws at the rear side of the cover (Fig. 31, pos.7) and the cover fastening screw (Fig. 9, pos. 6) at the front side of the KISS 2U V2 platform.

When inserting the cover, make sure that:

- ❑ At the front side: the fixing brackets (Fig. 31, pos. 4) are inserted properly into the corresponding retaining bracket of the chassis (Fig. 28, Fig. 29 and Fig. 30 pos. 1).
- ❑ At the rear side: the centring latches and the cover retaining plates (Fig. 28, Fig. 29, pos. 7 and 8, and Fig. 30 pos. 4 and 5) are properly inserted into the fixing bracket and centring slots of the cover (Fig. 31, pos.5 and 6).

The centering bracket (Fig. 31, pos. 3) and the front cover fastening screw Fig. 9, pos. 6) secure the cover on the front side. The fixing brackets with knurled screws (Fig. 31, pos. 7) secure the cover on the rear side.

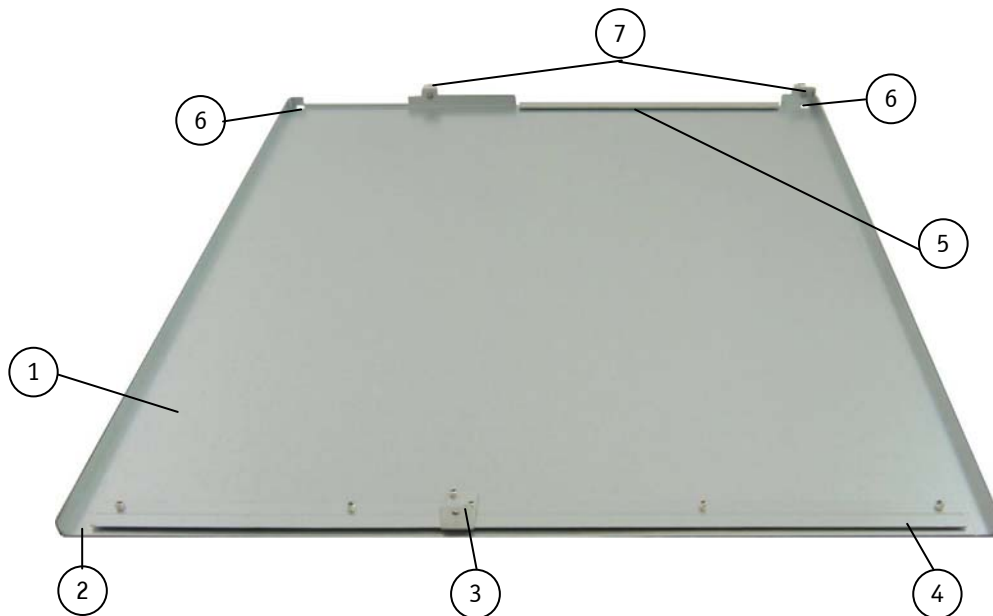

Fig. 31: Inside of the cover with fixing brackets

- | | |
|---|---------------------------------------|
| 1 Inside of the cover | 4 Fixing bracket (on the front side) |
| 2 Front part of the cover | 5 Fixing bracket (on the rear side) |
| 3 Angled centering bracket with tapped hole (on the front side) | 6 Centring slots on the cover |
| | 7 Fixing brackets with knurled screws |



In order to close the KISS 2U V2 platform chassis, ensure that the cover is properly reinstalled and secured with following screws:

- ❑ the cover fastening screw (Fig. 9, pos. 6) and Fig. 32) on the front side
- ❑ the knurled screws (Fig. 13, pos. 3, Fig. 17, pos. 6 and Fig. 33) on the rear side

8.3. Accessing Internal Components

This section contains important information that you must read before accessing the internal components. You must follow these procedures properly when handling any boards (refer also to the subsection 7.6.1 “Riser Card and/or Backplane and available Bays”).

8.3.1. Installing /Removing Expansion Cards

Please consider following instruction when you install (or remove) expansion cards.



When you install (or remove) expansion cards please consider the corresponding safety instruction of the included “General Safety Instruction for IT Equipment”.

The installation and removal of expansion cards have to be carried-out only by qualified specialist personnel in accordance with the description in this manual.

Before removing the device cover, ensure that your system is switched off and disconnected from the mains power supply.



Please refer to the ESD safety procedures for handling assemblies with static sensitive devices. Failure to take heed of this warning instruction can result in damage to the device.



Please read information provided by the manufacturer of any expansion cards before installing them or removing them from your system.

8.3.1.1. Installing /Removing Expansion Cards into KISS 2U V2 with SBC/Motherboard (not Low-Profile Cards)

To install or remove an expansion card proceed as follows:

1. Turn your system off and disconnect it from the main power source.



In order to remove the cover, unscrew the following knurled screws:

- the cover fastening screw (Fig. 9, pos. 6 and Fig. 32) at the front side
- the knurled screws (Fig. 13, pos. 3, Fig. 17, pos. 6 and Fig. 33) at the rear side

2. Loosen the knurled screws, which secure the cover on the front of the system.



Fig. 32: Loosen the cover fastening knurled screw on the front side



Fig. 33: Loosen the knurled screw on the rear side

3. Pull the cover out a little bit (Fig. 34) to release the cover centering and fixing brackets (Fig. 31, pos.3 and pos. 4) from the retaining plate of the chassis (see Fig. 28, Fig. 29, pos. 1) on the front side. At the same time the centering latches and the cover retaining plates (Fig. 28, Fig. 29, pos. 7 and 8) on the rear side will be removed from the fixing bracket and centering slots of the cover (Fig. 31, pos.5 and 6).



Fig. 34: This movement allow you to remove the centering and fixing bracket of the cover from the retaining plate of the chassis

4. Lift the cover up (on the rear edge) and remove it (Fig. 35).



Fig. 35: Removing the cover

The motherboard with the corresponding riser card (not in configuration for low-profile cards), respectively the SBC card with the corresponding butterfly-backplane are mounted on a card cage.

The card cage must be pulled-out a little bit from the chassis, in order to have access to the fastening screws of the slot bracket or expansion card slot bracket (Fig. 36).

5. For KISS 2U V2 systems with SBC, unscrew the three screws (Fig. 28, pos. 11) and the four screws on the rear side (Fig. 13 and Fig. 14, pos. 4). Retain the screws for later use.
6. For KISS 2U V2 systems with motherboard (not in configuration for low-profile cards), unscrew the four screws (Fig. 29, pos. 11) and the four screws on the rear side (Fig. 17, pos. 4). Retain the screws for later use.
7. Lift the card cage a little upwards, and slide it a little bit out.

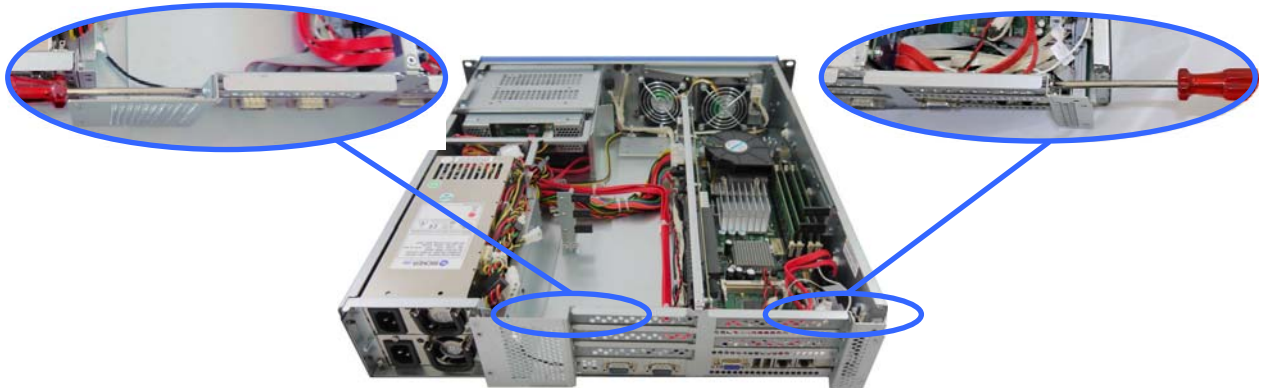

Fig. 36: Pulled-out card cage for configurations with SBC and motherboard, but not for configurations with motherboard for low profile cards (shown as a KISS 2U V2 system configuration with SBC)

8. Close the device and secure the cover with the knurled screws.
9. Insert/remove the expansion card/s in respectively out from the expansion slot/s of the motherboard, the riser card or butterfly backplanes and fix them, or the slot bracket/s to the rear of the card cage (see details of Fig. 36).
10. Close the system and secure the cover with the knurled screws as described in the section 8.2 "Cover".

For KISS 2U V2 system configuration with motherboard for low-profile expansion cards, it is not necessary to remove the card cage when installing the expansion cards.

8.3.1.2. Installing /Removing Low-Profile Expansion Cards into 2U V2 with Motherboard

To install or remove a low-profile expansion card in a system configuration with a motherboard, proceed as follows:

1. Open the system as described in subsection 8.3.1.1 (steps 1-4).
2. Unscrew the fastening screws of the slot bracket or card slot bracket (Fig. 30, pos. 6). Retain the screws for later use.
3. Insert/remove the expansion card/s respectively out from the expansion slot/s of the motherboard and fix them, or the slot bracket/s to the rear of the card cage.
4. Close the system and secure the cover with the knurled screws as described in section 8.2 "Cover".

8.4. Installation in a 19" Industrial Cabinet

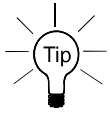

Expansion card installation should be performed before installing the KISS 2U V2-system into a 19" industrial cabinet.

Please consider the instructions described in the section 8.3 "Accessing Internal Components".

Before closing the industrial cabinet, you must connect your peripherals to the corresponding system ports.

For KISS 2U V2 versions and system configurations, please refer to the corresponding "KISS 2U V2 Systems - Configuration Guides" on our website www.kontron.com.

More information and technical data can be found in the corresponding board manual (motherboard or SBC, depending on the system configuration ordered).

You can download the manual from our web site at www.kontron.com by selecting the product.



Caution:

Energy hazards > 240 VA are present inside the chassis!

The system has to be mounted and installed only by a qualified service person for this area familiar with the associated dangers.

In order to setting-up, installing / removing the KISS 2U V2 system into/from a 19" industrial cabinet, please observe the instructions described in this user's guide.

Please consider the instructions described in the included "General Safety Instructions for IT Equipment".

Please consider the hints included in the subsection 7.2.4 "Power Supply Version and ON/OFF Switch of the PSU".

The KISS 2U V2 should be installed in a 19" industrial cabinet using slide rails (PN: 1016-5807). Use for mounting the "Rack Slide Rails Kit for KISS 1U and 2U/4U" (PN: 1051-7200).

Ensure that air flow around the device is adequate when installing the KISS 2U V2.

The openings for air intake and exhaust on the device must not be obstructed by objects.

Leave at least 5 cm (approx. 2") of free space to the 19" industrial cabinet in front and behind the KISS 2U V2, to prevent the device from possibly overheating.

The 19" industrial cabinet must stand firmly in place. You can improve its stability by placing the components into it from the bottom up. Heavy components should be placed down below.

If further stabilization is necessary, then bolt the 19" industrial cabinet to the floor or anchor it on the wall.

The voltage feeds must not be overloaded.

Adjust the cabling and the external overcharge protection to correspond with the electrical data indicated on the type label.

The type label is located on right side of the unit.

9. Starting Up



Please consider the Hints included in the chapter 4 “Safety Instructions”.

When used as intended the KISS 2U V2 platform is to operate only closed and locked.

Only when the cover is properly installed, secured with the knurled screws on the rear and the cover fastening screw on the front, and the access panel is locked with the key, it is ensured that the user doesn't have access to the internal parts of the KISS 2U V2 platform, loaded with hazardous energy.



The rated voltage of the mains (AC/DC) must agree with the voltage value on the type label.

9.1. AC Power Connection

The AC mains input socket is located on the rear side of the KISS 2U V2.



Hint for system configuration with AC Wide Range PSU!

Please observe that the ON/OFF switch of the AC wide range PSU (Fig. 22) does not disconnect the KISS 2U V2 platform from the main power source.

Even you turn off the system using the power button (Fig. 9, pos. 7) or the ON/OFF switch (Fig. 22) of this PSU, there is still a standby-voltage of 5 V_{Sb} on the motherboard or SBC. The unit is completely disconnected from the mains, only when the power cord is disconnected either from the mains or the unit.

Therefore, the power cord and its connectors must always remain easily accessible.



Please observe the settings option for “Restore on AC Power Loss” in the BIOS Setup.
Setting options: Power On/Power Off/Last State.



Hint for the ON/OFF switch of the AC wide range PSU (Fig. 22) for the KISS 2U V2 PCI760-A:

This switch is factory-set to “ON” and secured in this position by a bracket.

Don't switch OFF the PSU ON/OFF switch (Fig. 22) during operation. Please observe the hint on the attached label. Don't remove this label.

To connect the power cable, proceed as follows:

1. The KISS 2U V2 systems with grounding studs marked with a PE symbol (Fig. 25) have to be grounded by establishing a large-area contact between the grounding stud and an appropriate grounding connection point (refer to the subsection 7.2.5 “Grounding Stud”, Fig. 25 and Fig. 26).
2. Connect the AC power cord to the AC input connector.
3. Connect the other end of the AC power cord to a corresponding mains outlet.



Use a power cord suitable for the mains power supply in your country.

Make sure that the mains power supply (power outlet) is properly grounded and that the power cord is in perfect condition without any visible damage. An ungrounded power supply is not permissible.

9.2. DC Power Connection

The DC version of the KISS 2U V2 platform is equipped with a +24V or -48V power supply (with a 2-pin terminal block and an ON/OFF power switch)



It must be ensured that the platform can be powered ON and OFF via an easy accessible two pole isolating switch and an overload protection. These should be incorporated in the building installation wiring. The unit is only completely disconnected from the DC power source, when:

- it is switched OFF via the ON/OFF switch of the DC PSU
- or
- the DC power cord is disconnected either from the power source or the unit. Therefore, the DC power cord and its connectors must always remain easily accessible.



Please ensure that during the DC connection procedure, there is no power flowing from the external DC power source to the KISS 2U V2 system.

9.2.1. Attaching the Ferrite Core



Before you connect the KISS 2U V2 with DC Power Supply Unit (PSU) to a DC power source, you have to attach the ferrite core (7427113, manufacturer: Würth Elektronik) to the wires that are used for the power connection:

- 2x 2x wires with a minimum cross section of 2.5 mm² for the +24VDC PSU
- 2x wires with a minimum cross section of 1.5 mm² for the -48VDC PSU

Only with the attached ferrite core are ensured the requirements of EMC standards (for emission and immunity).

Do not close the ferrite core before you have attached it to the power wires!

To attach the ferrite core, proceed as follows:

1. Open the ferrite core as much as possible.
2. Put the two wires together.
3. Lay the wires into the middle channel of the one half of the ferrite core, at 5-8 cm (2-3 in) to one end of the wires. Run the wires lengthwise, one time around the ferrite core (*see figure below*), so that the wires are running out at the other end of the ferrite core.
4. Fold the two halves of the ferrite core, without closing the ferrite case completely.
5. Check the location of the wires in the channel of the ferrite core. If the winding loop is too large, you have to reduce it, by pulling the end of the longer wires.
6. Close the ferrite core completely until the clamp snaps in place.

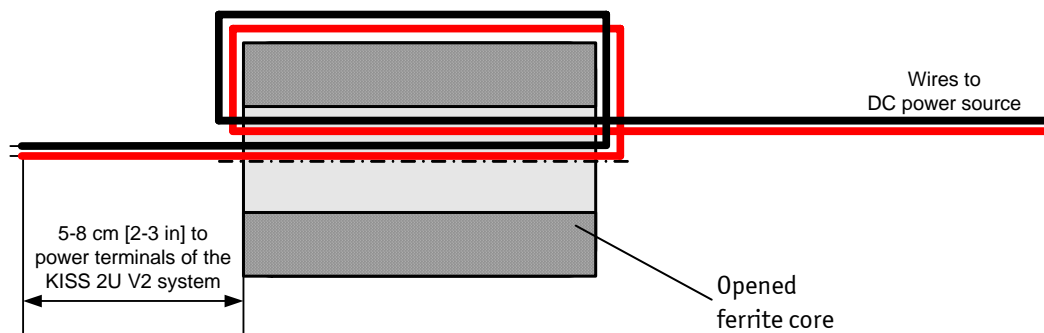

Fig. 37: Opened ferrite core with wires

9.2.2. DC Power Cord Connection



Please ensure that during the DC connection procedure, there is no power flowing from the external DC power source to the KISS 2U V2 system.

1. Prepare two isolated wires (minimum cross section of 2.5 mm² for the +24VDC PSU and minimum cross section of 1.5 mm² for the -48VDC PSU) with attached ferrite core (refer to the subsection 9.2.1 “Attaching the Ferrite Core”), according to the connectors of the screw terminal.
2. Loosen the two cross-head screws of the screw terminal so that you can insert the stripped ends of the wires. Pay attention to the polarity of the wires.
3. Fasten the cross-head screws firmly.
4. Cover the connectors of the screw terminal with the protective cover available.



After attaching the cables to the terminals of the DC PSU (+24VDC or -48VDC) always operate the DC versions of KISS 2U V2 systems with the protective cover provided.

5. Prepare the other ends of the wires according to the terminal of the DC power source.
6. Connect the wires prepared to the DC power source. Pay attention to the polarity of the connectors. The DC power source has to be switched off.
7. Switch on the DC power source.

9.3. Operating System and Hardware Component Drivers

Your computer can optionally be supplied with or without pre-installed operating system.

If you have ordered your KISS 2U V2 with pre-installed operating system, all drivers are installed, corresponding to the ordered computer configuration (optional hardware components). Your computer is fully functional when you turn it on for the first time.

If you have ordered your KISS 2U V2 without pre-installed operating system, you have to install the operating system and the corresponding drivers for the ordered computer configuration (optional hardware components).



The needed drivers can be downloaded from the web page www.kontron.com by selecting the product.



Consider the manufacturer specifications of the operating system and the integrated hardware components.

10. Maintenance and Prevention

Kontron Europe systems only require minimal maintenance and care to keep them operating correctly.

- ❑ Occasionally wipe the system with a soft dry cloth.
- ❑ Remove persistent dirt by use of a soft, slightly damp cloth (only use a mild detergent).
- ❑ Clean the air filter mat regularly (refer to the section 10.2 “Cleaning the Filter Mat”).

10.1. Replacing System Fans



The operation of the KISS 2U V2 platform is permitted only with a functional fan slide-in module. Defective components may be replaced only by Kontron original spare parts.

- ❑ part number of the fan slide-in module: 1050-8442

Important instructions!

The fan slide-in module is changeable while the system is powered-up. This maintenance may only be carried out by qualified personnel familiar with the associated dangers.

To replace the fan slide-in module, proceed as follows:

1. Remove the air filter mat as described in the section 10.2 “Cleaning the Filter Mat” (step 1 to 3) and put it aside for later use.
2. Loosen the two knurled screws of the fan slide-in module (Fig. 38, pos. 1)
3. Pull the fan slide-in module out to disconnect it from the internal fan control socket (Fig. 39, pos. 3).
4. Lift the slide-in module upwards in the arrow direction to remove it from the fan compartment (see Fig. 39).

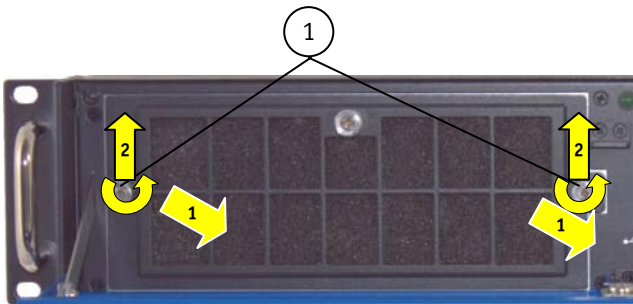

Fig. 38: Detail: removing the fan slide-in module

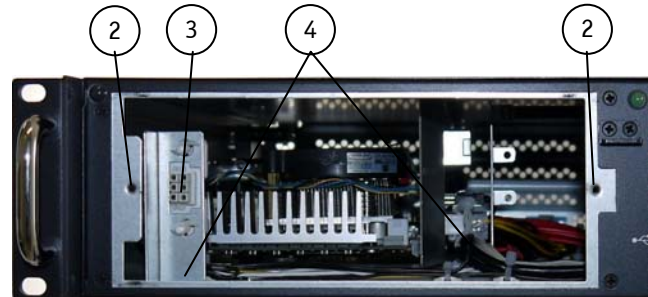

Fig. 39: Detail: Fan compartment (without fan slide-in module)

Legend for Fig. 38 and Fig. 39:

- | | |
|---|---|
| 1 Fan slide-in module with two knurled screws | 3 Socket for fan power supply and control |
| 2 Threaded holes (chassis frame) for securing the fan slide-in module | 4 Fan compartment |

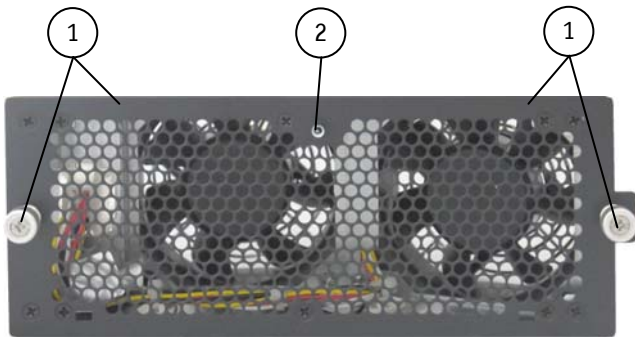

Fig. 40: Fan slide-in module without filtermat holder

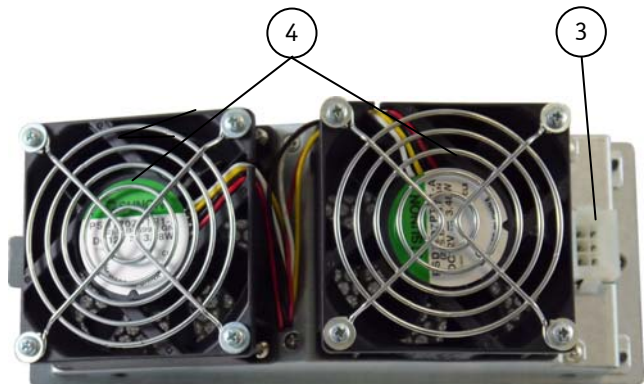

Fig. 41: Rear view of the fan slide-in module



Fig. 42: Fan slide-in module with mounted filter mat holder



Fig. 43: Side view of the fan slide-in module

Legend for Fig. 40 and Fig. 41:

- | | |
|--|--|
| 1 Fan slide-in module with two knurled screws | 3 Socket for fan power supply and control |
| 2 Bolt with tapped hole for mounting the filter mat holder | 4 2x fans (temperature controlled independently from each other) |

5. Replace the fan slide-in module with a new functional module.
6. Insert the retained filter mat holder (with filter mat) to the front side of the fan slide-in module as described in the section 10.2 "Cleaning the Filter Mat" (step 7 and step 8).
7. Slide the fan slide-in module with mounted filter mat holder (Fig. 42) into the fan compartment (Fig. 39, pos. 4).
8. Push the fan slide-in module into the fan compartment until the fan control connector (Fig. 41, pos. 2) is firmly inserted into the socket (Fig. 39, pos. 3).
9. Fasten the knurled screws of the fan slide-in module (Fig. 38, pos. 1)

10.2. Cleaning the Filter Mat

The filter mat is inserted in the filter mat holder at the front side of the fan slide-in module (Fig. 44, pos. 4). The soiling of the filter mat is caused by the pollution of the operating environment. A heavily soiled filter mat can cause excessive heating of the device. For this reason we recommend to clean the filter mat as often as necessary. The filter mat can be replaced during operation of the system.

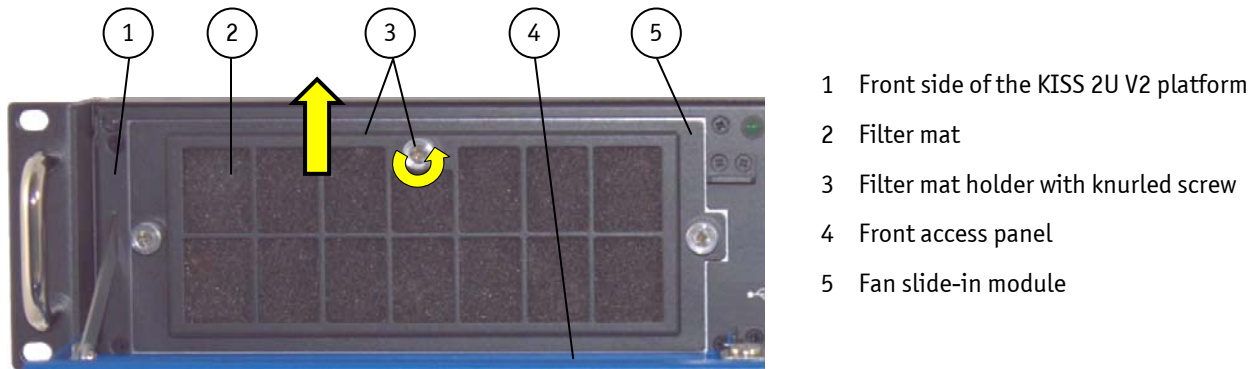

Fig. 44: Detail with filter mat holder on the front side of the KISS 2U V2 platform

To replace the filter mat, proceed as follows:

1. Open the front access panel (Fig. 44, pos. 4).
2. Loosen the knurled screw that secures the filter mat holder to the fan slide-in module (Fig. 44, pos. 3 and Fig. 46, pos. 5).
3. Pull the filter mat holder out from the positioning holes (Fig. 45, pos. 3) in the direction marked with the arrow (Fig. 44) and lift it off.
4. Remove the dirty filter mat.
5. Clean the filter mat as follows:
 - Rinse in water (up to approx. 40°C/104°F; you may add a mild commercial detergent).
 - It is also possible to beat it, suction clean it or blast it with warm compressed air.
 - If the filter is soiled with greasy dust, you should rinse it with warm water with degreaser added. Do not clean the air filter mat with a piercing jet of water or wring it out.
6. After cleaning and drying the filter pad, place it in the filter mat holder (see Fig. 47).
7. Reattach the filter mat holder to the front side of the fan slide-in module by inserting the positioning latches (Fig. 46, pos. 6) into the positioning holes (Fig. 45, pos. 3).
8. Fasten the filter mat holder by tightening the knurled screw (Fig. 46, pos. 1) to the bolt with tapped hole (Fig. 45, pos. 1) at the fan slide-in module.



Defective components may only be replaced by Kontron original spare parts.

Air filter mat: part number: 1050-8374.

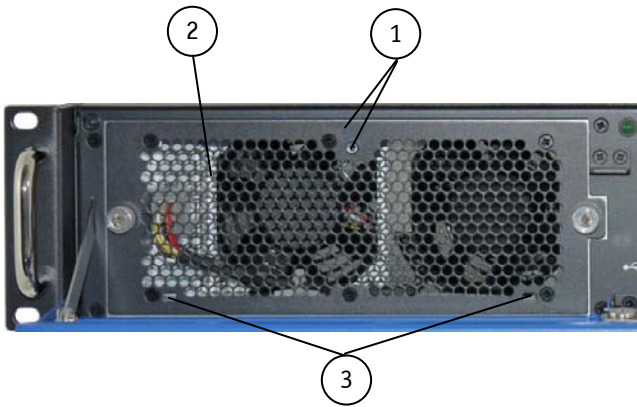

Fig. 45: Detail without filter mat holder on the front side

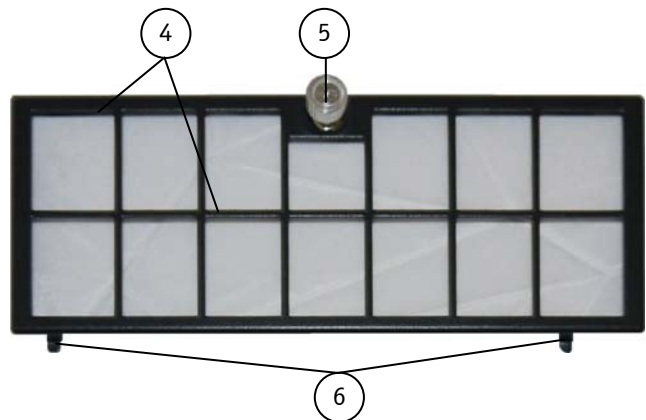

Fig. 46: Filter mat holder without filter mat



Fig. 47: Filter mat holder with filter mat

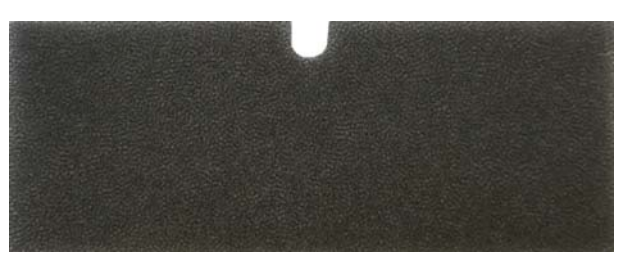

Fig. 48: Filter mat

Legende für Fig. 45 und Fig. 46:

- | | |
|--|--|
| 1 Fan slide-in module with bolt with tapped hole | 4 Filter mat holder |
| 2 Air intake openings at the front side of the fan slide-in module | 5 Knurled screw of the filter mat holder |
| 3 Positioning holes for the filter mat holder | 6 Positioning latches of the filter mat holder |

10.3. Replacing the Lithium Battery

The motherboard or SBC card for your system is equipped with a lithium battery. To replace the lithium battery, proceed as follows:

1. Open the device, as described in the subsection 8.3.1 "Installing /Removing Expansion Cards" chapter (steps 1-4).
2. If you have added expansion cards to your system, first remove the expansion cards and all corresponding connecting cables, to gain access to the lithium battery.
3. Remove the lithium battery from the holder by pulling the ejector spring outwards.
4. Place a new lithium battery in the battery holder.
5. Pay attention to the polarity of the battery.
6. The lithium battery must only be replaced with the same type of battery or with a type of battery recommended by Kontron Europe.
7. Reinstall the removed expansion cards and re-attach the connecting cables.
8. Close the device, as described in the subsection 8.3.1 "Installing /Removing Expansion Cards" chapter (step 10).



Do not dispose of lithium batteries in general trash collection. Dispose of the battery according to the local regulations dealing with the disposal of these special materials, (e.g. to the collecting points for dispose of batteries).

11. Slide Rails (Option)

Kontron provides slide rails for installing the KISS 2U V2 in a 19" industrial cabinet. These slide rails can be ordered separately.



The KISS 2U V2 systems should be installed into a 19" industrial cabinet with slide rails (PN: 1016-5807). Use therefore the rack slide rails mounting kit for KISS 1U and KISS 2U/4U V2 systems (PN: 1051-7200).

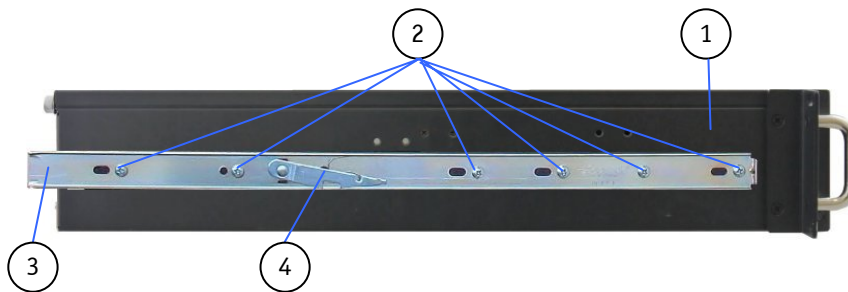

Fig. 49: Attached inner part of the slide rail (shown left side view of the KISS 2U V2 system)

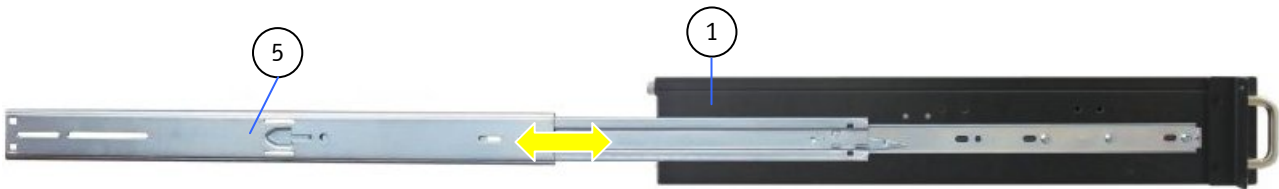

Fig. 50: KISS 2U V2 platform with slide rail in pulled-out position



Fig. 51: KISS 2U V2 platform with slide rail in pushed-in position

Legend for: Fig. 49, Fig. 50 and Fig. 51:

- | | |
|---|-------------------------------------|
| 1 Side view of the KISS 2U V2 | 4 Locking lever |
| 2 6x M4x6 Philips screw
(on each side) | 5 Slide rail in pulled-out position |
| 3 Inner part of the slide rail | 6 Slide rail in pushed-in position |



Please ensure that only the screws provided (M4x6) are used to attach the slide rails to the KISS 2U V2.

12. Technical Data

KISS 2U V2-xxxxxxx-y	
Installed CPU Card	* Refer to „KISS 2U V2 System - Configuration Guide“
Controls and Indicators (at the front side)	Power button Power LED (green) HDD LED (orange)
Operating Elements (at the rear side)	1x ON/OFF switch of the PSU: for system configuration with +24VDC or -48VDC PSU 1x N/OFF switch of the PSU: for system configuration with AC wide range PSU (doesn't disconnect the unit from the mains)
Indicators (at the rear side)	2x Power LED (green) of the redundant PSU 1x Alarm LED (red) of the redundant PSU
Interfaces (at the front side)	2x USB (2.0)
Interfaces (at the rear side)	I/O of the installed CPU card (motherboard/SBC) * refer to the manual of the installed CPU card (motherboard/SBC)
Drive Bays	Up to two drive bays * optionally equipped (depending on the system configuration ordered (refer to „KISS 2U V2 System - Configuration Guides“))
Free Expansion Slots	* optionally equipped (depending on the system configuration ordered (refer to „KISS 2U V2 System - Configuration Guides“))
Lithium Batterie	* refer to the manual of the installed CPU card (motherboard/SBC)
Equipped Power Supply Unit	<ul style="list-style-type: none"> • AC Wide Range 100-240V or • AC redundant Wide Range 100-240V or • +24 VDC or • -48VDC
Rated Voltage Range	See type label



KISS 2U V2 = System type

The “xxxxxxx” group is replaced by up to a max. 8-digit combination of numbers, letter or space, and represents the installed CPU board

The “y” is replaced by a single letter (A through Z) representing the power supply installed into the system.

The corresponding “KISS 2U V2 System - Configuration Guides” and the manual of the installed CPU card can be downloaded from our web site at www.kontron.com by selecting the product name.

12.1. Electrical Specifications

The corresponding electrical specifications of your KISS 2U V2 platform can be found on the type label.

12.2. Mechanical Specifications

Dimensions	KISS 2U V2 (Standard Version)
Height	2U (88 mm) (3.5")
Width	Front: 19"; Chassis: 430 mm (16.9")
Depth	Chassis: 472.3 mm (18.6")
Weight (without packaging)	Aprox. 10.00 kg (22.046 lbs.)
Chassis	Chassis, black (RAL 7021) Front access panel: blue (RAL 5017)

12.3. Environmental Specifications

Thermal Management	2x system fan (temperature-controlled) PSU fan CPU fan
Operating Temperature / Relative Humidity	0 ... +50 °C @5-95 % not condensing [at +55 °C (131 °F) at 10% POH per month] (32 .. 122 °F @5-95 % not condensing [+55 °C (131 °F) at 10% POH per month]
Storage / Transport Temperature / Relative Humidity	-20 ... +70 °C @ 5-95 % not condensing (-4 ... 158 °F @ 5-95 %) not condensing
Max. Operation Altitude	2,000 m (6,560 ft)
Max. Storage / Transport Altitude	10,000 m (32,810 ft)
Operating Shock	15 G, 11 ms, half sine
Storage / Transit Shock	30 G., 11 ms, half sine
Operating Vibration	10 – 500 Hz, 1.0 G
Storage / Transit Vibration	10 – 500 Hz, 2.0 G
Acoustic Noise	< 35 dB(A) (at 1 m in front of the system, full load) ~ 40 dB(A) for systems with Intel® Quad Core™ processor or redundant PSU

12.4. Directives and Standards

CE Directive	
Elektrical Safety	General Product Safety Directive (GPSD) 2001/95/EC Low Voltage Directive (LVD) 2006/95/EC
Electromagnetic Compatibility (EMC)	EMC Directive 2004/108/EC
CE Marking	CE Directive 93/68/EEC

Elektrical Safety	Harmonized Standards
EUROPE	Information technology equipment - Safety - Part 1: General requirements EN 60950-1: 2006
U.S.A. / CANADA	to meet UL60950-1:2007 / CSA C22.2- No. 60950-1-7:2007

EMC	Harmonized Standards
EU	Generic emission standard for industrial environments (Emission): EN 61000-6-4:2007 Generic standards - Immunity for industrial environments (Immunity): EN 61000-6-2:2005
U.S.A.	FCC 47 CFR Part 15, Class A
CANADA	ICES-003, Class A

13. Standard Interfaces – Pin Assignments

Low-active signals are indicated by a minus sign.

13.1.1. Serial Interface (RS232)

Pin	Signal Name	9-pin D-SUB Connector (male)
1	DCD (Data Carrier Detect)	
2	RXD (Receive Data)	
3	TXD (Transmit Data)	
4	DTR (Data Terminal Ready)	
5	GND (Signal Ground)	
6	DSR (Data Set Ready)	
7	RTS (Request to Send)	
8	CTS (Clear to Send)	
9	RI (Ring Indicator)	

13.1.2. VGA Port

Pin	Signal Name	15-pin D-SUB Connector (female)
1	Analog red output	
2	Analog green output	
3	Analog blue output	
4	N.C.	
5-8	GND	
9	+5 V (DDC)	
10	GND	
11	N.C.	
12	SDA (DDC)	
13	TTL HSync	
14	TTL VSync	
15	SCL (DDC)	

13.1.3. USB Port

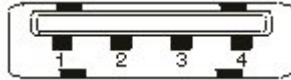
Pin	Signal Name	4-pin USB Connector Type A Version 2.0
1	VCC	
2	Data-	
3	Data+	
4	GND	

13.1.4. PS/2 Keyboard Connector

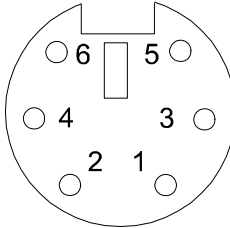
Pin	Signal Name	6-pin Mini-DIN Connector
1	Keyboard Data	
2	N.C.	
3	GND	
4	+5 V	
5	Keyboard Clock	
6	V.C.	

13.1.5. PS/2 Mouse Connector

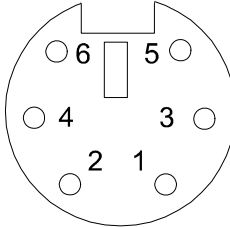
Pin	Signal Name	6-pin Mini-DIN Connector
1	Mouse Data	
2	N.C.	
3	GND	
4	+5 V	
5	Mouse Clock	
6	N.C.	

14. Technical Support

For technical support, please contact our Technical Support department:

Tel: +49 (0) 8165/77 112

e-mail: support-keu@kontron.com

Web: <http://www.kontron.com/support>

Make sure you have the following information on hand when you call:

- the unit part id number (PN),
- the serial number (SN) of the unit; the serial number can be found on the type label, placed on the right side of the system.

Be ready to explain the nature of your problem to the service technician.

If you have questions about Kontron Europe or our products and services, you can reach us by the above-mentioned telephone number and on e-mail address or at: www.kontron.com.

14.1. Returning Defective Merchandise

Please follow these steps before you return any merchandise to Kontron Europe:

1. Download the corresponding form for returning a device with an RMA No. [RMA (Return of Material Authorization)] from our website [www.kontron.com/Support/.RMA Information](http://www.kontron.com/Support/.RMA%20Information); contact our Customer Service department to obtain an RMA No.
e-mail: service@kontron.com
2. Ensure that you have received an RMA number from Kontron Customer Services before returning any device. Write this number clearly on the outside of the package.
3. Describe the fault that has occurred.
4. Please provide the name and telephone number of a person we can contact to obtain more information, where necessary. Where possible, please enclose all the necessary customs documents and invoices.
5. When returning a device:
 - Pack it securely in its original box.
 - Enclose a copy of the RMA form with the consignment.

Corporate Offices

Europe, Middle East & Africa	North America	Asia Pacific
Oskar-von-Miller-Str. 1 85386 Eching/Munich Germany Tel.: +49 (0)8165/ 77 777 Fax: +49 (0)8165/ 77 219 info@kontron.com	14118 Stowe Drive Poway, CA 92064-7147 USA Tel.: +1 888 294 4558 Fax: +1 858 677 0898 info@us.kontron.com	17 Building,Block #1,ABP. 188 Southern West 4th Ring Beijing 100070, P.R.China Tel.: + 86 10 63751188 Fax: + 86 10 83682438 info@kontron.cn

