

# User Manual

for the

## 820950 ADD2-LVDS-Dual card 820953 ADD2-LVDS-Single card



AGP Digital Display second generation card with Low Voltage Differential Signaling Transmitter  
Designed primarily for 986LCD-M family and KT965/Flex motherboards



**820950 ADD2-LVDS-Dual**



**820953 ADD2-LVDS-Single**

	ADD2-LVDS-Dual	ADD2-LVDS-Single
Part no.	820950	820953
PCB no.	30103260	30103260
Ass. no.	68600002	68400000

## Document revision history.

Revision	Date	By	Comment
D	Sept. 16 <sup>th</sup> 2008	MLA	Page 7, "PWR connector" text improved.
C	Sept. 4 <sup>th</sup> , 2007	MLA	MB specific configuration added to Installation Guide.
B	Aug. 20 <sup>th</sup> , 2007	MLA	820953 Picture added. Minor layout changes.
A	Mar. 13 <sup>th</sup> , 2007	MLA	Add ADD2-LVDS-Single
0	Jan. 19 <sup>th</sup> , 2007	MLA	Preliminary version.

### Copyright Notice:

Copyright © 2007, KONTRON Technology A/S, ALL RIGHTS RESERVED.

No part of this document may be reproduced or transmitted in any form or by any means, electronically or mechanically, for any purpose, without the express written permission of KONTRON Technology A/S.

### Trademark Acknowledgement:

Brand and product names are trademarks or registered trademarks of their respective owners.

### Disclaimer:

KONTRON Technology A/S reserves the right to make changes, without notice, to any product, including circuits and/or software described or contained in this manual in order to improve design and/or performance. Specifications listed in this manual are subject to change without notice. KONTRON Technology assumes no responsibility or liability for the use of the described product(s), conveys no license or title under any patent, copyright, or mask work rights to these products, and makes no representations or warranties that these products are free from patent, copyright, or mask work right infringement, unless otherwise specified. Applications that are described in this manual are for illustration purposes only. KONTRON Technology A/S makes no representation or warranty that such application will be suitable for the specified use without further testing or modification.



## Life Support Policy

KONTRON Technology's PRODUCTS ARE NOT FOR USE AS CRITICAL COMPONENTS IN LIFE SUPPORT DEVICES OR SYSTEMS WITHOUT EXPRESS WRITTEN APPROVAL OF THE GENERAL MANAGER OF KONTRON Technology A/S.

As used herein:

1. Life support devices or systems are devices or systems which, (a) are intended for surgical implant into body, or (b) support or sustain life and whose failure to perform, when properly used in accordance with instructions for use provided in the labeling, can be reasonably expected to result in significant injury to the user.
2. A critical component is any component of a life support device or system whose failure to perform can be reasonably expected to cause the failure of the life support device or system, or to affect its safety or effectiveness.

## KONTRON Technology Technical Support and Services

If you have questions about installing or using your KONTRON Technology Product, check this User's Manual first – you will find answers to most questions here. To obtain support, please contact your local Distributor or Field Application Engineer (FAE).

**Before Contacting Support:** Please be prepared to provide as much information as possible:

- ADD-On Board
  1. Type.
  2. Part-number (Number starting with "68").
- Configuration
  1. Motherboard Type
  2. BIOS Revision (Find the Version Info (BIOS ID) in the BIOS Setup Menu)
  3. BIOS Settings different than *Default* Settings (Display related settings).
  4. O/S Make and Version.
  5. Graphic Driver Version numbers.
  6. Attached LCD Panel(s) etc.



**Table of contents:**

<b>INTRODUCTION .....</b>	<b>5</b>
<b>MECHANICAL DRAWING .....</b>	<b>5</b>
<b>FUNCTIONAL DIAGRAM .....</b>	<b>6</b>
<b>CONNECTOR POSITION .....</b>	<b>7</b>
<b>CONNECTOR DESCRIPTION .....</b>	<b>7</b>
<b>INSTALLATION GUIDE .....</b>	<b>9</b>
<b>ELECTRICAL SPECIFICATION .....</b>	<b>10</b>
<b>APPENDIX: HOW TO REMOVE LVDS CONNECTOR .....</b>	<b>11</b>
<b>APPENDIX: THE 820971 LDI EVALUATION KIT .....</b>	<b>12</b>

## Introduction

- Single or dual LVDS Transmitter each working as Single/Dual LVDS Transmitter up to 165Mpixels/s
- Panel fitting scalar-up scale to 1600x1200
- Panel resolution up to 1920x1200 (@60Hz Frame Rate)
- The ADD2-LVDS-Dual supported by KT965 Family
- The ADD2-LVDS-Single supported by KT965 and 986LCD-M Families
- LVDS low jitter PLL accepts spread spectrum input
- LVDS 18-bit and 24-bit output
- 2D dither engine
- Panel protection and power sequencing
- High-speed SDVO1 serial (1G~2Gbps) AC-coupled differential RGB inputs
- Low voltage interface support to graphics device
- Programmable power management
- Fully programmable through serial port
- Configuration through opcodes1
- Complete Windows and DOS driver support
- 3.3/5V LCDVCC selection
- Backlight Signal inversion selection

The ADD2-LVDS cards are based on the Chronitel CH7308A LVDS transmitter. The ADD2-LVDS-Dual is equipped with two CH7308A and supports two independent displays having resolutions up to 1600x1200 (1920x1200 possible). The ADD2-LVDS-Single only has one CH7308A. The cards are designed for the PCI-Expressx16 connector which on the 986LCD-M family of motherboards and on the KT965/Flex motherboard is multiplexed PCI-Expressx16 and SDVO. When the ADD2-LVDS card is plugged into the PCI-Expressx16 connector then the motherboard automatically detects the card and select SDVO output. The card operates at pixel rates of up to 165MHz per link, supporting 1920x1200 panels at a 60Hz refresh rate. The LVDS transmitter includes a panel fitting up-scaler and a programmable dither function to support 18-bit LCD panels. Data is encoded into commonly used formats, including those specified in the OpenLDI and the SPWG specifications.

## Mechanical Drawing

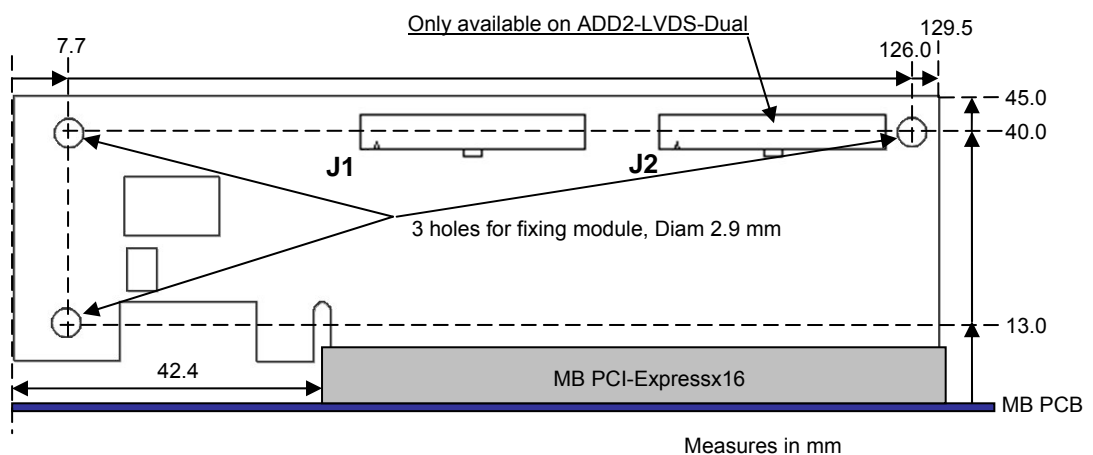

## Functional Diagram

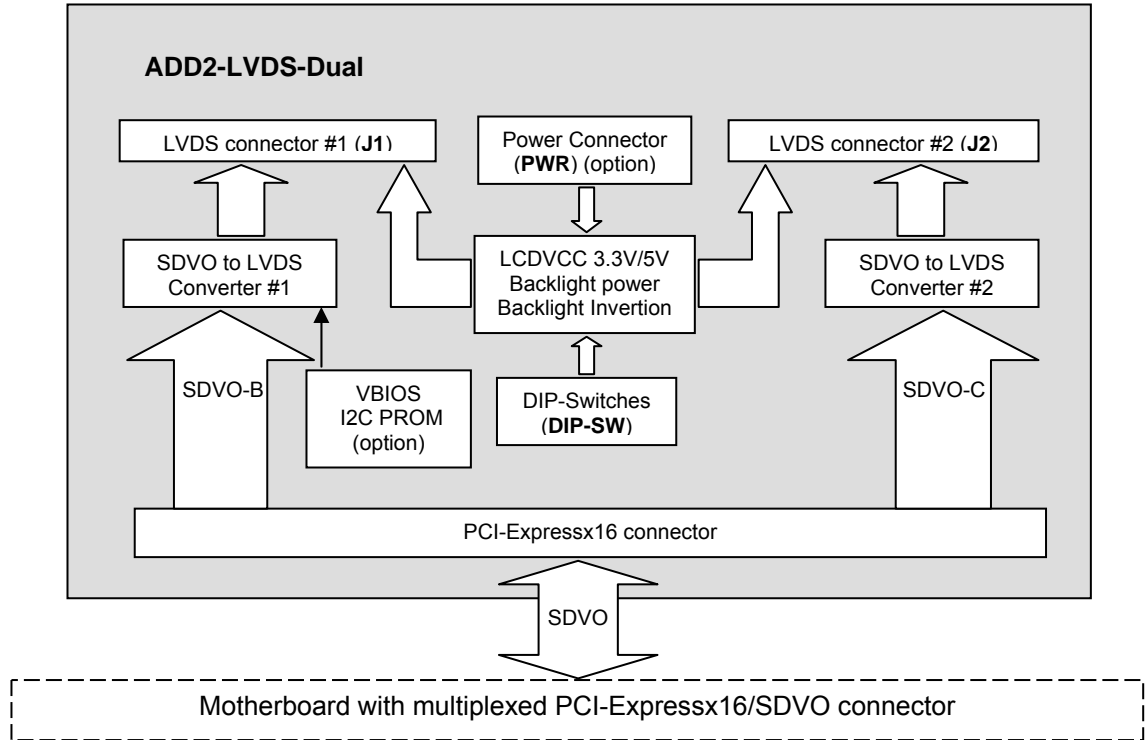

Note that VBIOS located in I2C is not used as default. The reason is that the BIOS located in the Kontron Motherboards of 986LCD-M family and in KT965/Flex are supporting the ADD2-LVDS card directly.

The “LVDS connector #2” and the “SDVO to LVDS Converter #2” circuit are only mounted on the ADD2-LVDS-Dual version.

## Connector Position

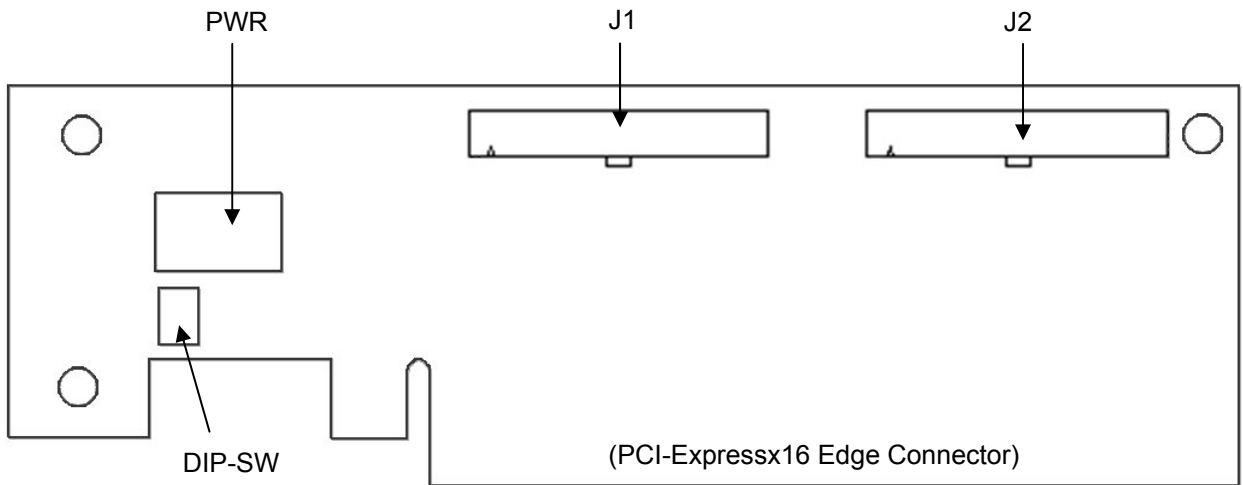

PWR = Power Connector for adding power if required

DIP-SW = DIP Switches for selecting LCDVCC and Backlight Signal Inversion

J1 = LVDS Flat Panel Connector no. 1

J2 = LVDS Flat Panel Connector no. 2 (not available on ADD2-LVDS-Single).

## Connector Description

### PWR connector (4-pole power)

Connector type is AMP 2-171826-4. A standard FDD power plug can be connected to the PWR connector.

Pin	Function	Note
1	+5V	Max 2A
2	GND	Total current on pin 2-3: Max 6A
3	GND	
4	+12V	Max 4A

It's necessary to connect the power plug if:

- a. At least one of the display/cable kits require 5V as LCDVCC
- b. If more than 4A in total is required for +12V Backlight.

### DIP-SW = DIP Switches

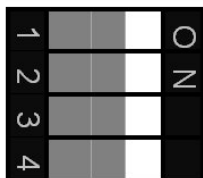

- Off/On => J1 LCDVCC power = 3.3V/5V
- Off/On => J2 LCDVCC power = 3.3V/5V
- Off/On => J1 BKLON signal active Low/High
- Off/On => J2 BKLON signal active Low/High

**WARNING:** Default position of the switches is ON-position. If connected display requires 3.3V as LCDVCC then make sure the relevant Dip-Switch (1 or 2) is in the Off position (LCDVCC = 3.3V).

## LVDS Flat Panel Connector J1 and J2.

Connector type is Don Connex C44-40-B-G-1. Mating connector can be Don Connex A32-40-C-G-B-1 (Kontron item no. 910000005).

The J1 and J2 connector are identical, but J2 is only available on the ADD2-LVDS-Dual version.

Note	Type	Signal	Pin		Signal	Type	Note
Max. 0.5A	PWR	+12V	1	2	+12V	PWR	Max. 0.5A
Max. 0.5A	PWR	+12V	3	4	+12V	PWR	Max. 0.5A
Max. 0.5A	PWR	+12V	5	6	GND	PWR	Max. 0.5A
Max. 0.5A	PWR	+3.3V	7	8	GND	PWR	Max. 0.5A
Max. 0.5A	PWR	LCDVCC	9	10	LCDVCC	PWR	Max. 0.5A
5K6Ω, LCDVCC	OT	DDC CLK	11	12	DDC DATA	OT	5K6Ω, LCDVCC
110RΩ, 3.3V	PWR	3.3V signal	13	14	VDD ENABLE	OT	3.3V level
3.3V level	OT	BKLTEN#	15	16	GND	PWR	Max. 0.5A
	LVDS	LVDS A0-	17	18	LVDS A0+	LVDS	
	LVDS	LVDS A1-	19	20	LVDS A1+	LVDS	
	LVDS	LVDS A2-	21	22	LVDS A2+	LVDS	
	LVDS	LVDS ACLK-	23	24	LVDS ACLK+	LVDS	
	LVDS	LVDS A3-	25	26	LVDS A3+	LVDS	
Max. 0.5A	PWR	GND	27	28	GND	PWR	Max. 0.5A
	LVDS	LVDS B0-	29	30	LVDS B0+	LVDS	
	LVDS	LVDS B1-	31	32	LVDS B1+	LVDS	
	LVDS	LVDS B2-	33	34	LVDS B2+	LVDS	
	LVDS	LVDS BCLK-	35	36	LVDS BCLK+	LVDS	
	LVDS	LVDS B3-	37	38	LVDS B3+	LVDS	
Max. 0.5A	PWR	GND	39	40	GND	PWR	Max. 0.5A

Signal Description – LVDS Flat Panel Connector:

Signal	Description
LVDS A0..A3	LVDS A Channel data
LVDS ACLK	LVDS A Channel clock
LVDS B0..B3	LVDS B Channel data
LVDS BCLK	LVDS B Channel clock
3.3V Signal	100Ω to 3.3V. Can be used to generate 0-3.3V by potentiometer etc. for backlight intensity control.
BKLTEN#	Backlight Enable signal, Active Low (~GND) as default. Use DIP-SW3/4 to select Active High (~3.3V).
VDD ENABLE	Output Display Enable. Active High (~3.3V).
LCDVCC	VCC supply to the flat panel. This supply includes power-on/off sequencing. The flat panel supply may be either 3.3V (default) or 5V depending on the DIP-SW1/2. If 5V is requested then PWR connector must be used. Maximum load is 1A.
DDC CLK	DDC Channel Clock. Pull-up resistor to LCDVCC.
DDC DATA	DDC Channel Data. Pull-up resistor to LCDVCC.



## Installation Guide

### Cable kit

Available Cable Kits:

821155 Open End LVDS Cable 1080mm  
 821514 Cable for Sharp LQ121S1LG41  
 821515 Open End LVDS Cable 540mm  
 821517 LVDS Cable 2x40p conn 405 mm  
 821518 Cable for AUO G121SN01  
 821520 Cable for LG.Philips LM150X8  
 820971 LDI Evaluation  
 820972 Cable Samsung LTM201U1-L01  
 820973 Cable for Sharp LQ201U1LW01

Available module:

820975 LDI Module (integrated part of 820971, 820972 and 820973)

### PWR connection/LDI use

Depending on the connected type(s) of display(s) the PWR must be connected and/or LDI(s) must be used. See tables below

PWR connected	LDI used	LCDVCC			Backlight	
		3.3V	5V	5 – 30V	12V	5 – 30V
no	no	<1A	0	0	<2.2A (*)	0
yes	no	<1A	<1A	0	<2.2A	0
no	yes	<1A	0	<4A	<2.2A (*)	<4A
yes	yes	<1A	<1A	<4A	<2.2A	<4A

(\*) Maximum 4A for both display systems

### DIP-Switch settings

Dip-SW contains 4 switches SW1 – SW4, which are used to configure LCDVCC and Backlight control signal. Remove the foil before changing the position of the Dip-Switches.

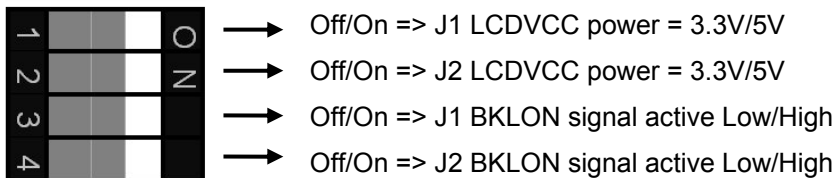

**WARNING:** Default position of the switches is ON-position. If connected display requires 3.3V as LCDVCC then make sure the relevant Dip-Switch (1 or 2) is in the Off position (LCDVCC = 3.3V).

### Mounting

The 3 holes for fixing the ADD2-LVDS card is recommend to be used.



## For KT965 motherboard in single - or dual LVDS display configuration.

The display connected to the J1 LVDS port can be activated from BIOS by selecting the [CRT+LFP] or [LFP] and the display connected to the J2 LVDS card can not be activated from BIOS, only via Intel Graphics Media Accelerator Driver. The driver for the display connected to J1 can be selected in BIOS. The driver for the display connected to J2 can not be selected; it will use the same display driver as selected for the J1 connection.

In BIOS select:

Chipset > NorthBridge Chipset Configuration > Video Function Configuration >  
Boot Type = [CRT+LFP] or [LFP] or [CRT]  
SDVO = [select display type no.]

By selecting Secure CMOS (or OEM Failsafe) it is possible to prevent Windows from changing the BIOS "Boot Type" setting. For Windows use the Intel Graphics Media Driver version 6.14.10.4859 (win2K\_xp1431.exe) or newer. Clone mode is not supported in dual LVDS application.

## For 986LCD-M motherboard in dual LVDS display configuration.

(For single LVDS display application use onboard LVDS port, no ADD2-LVDS card is required).

The display connected to the onboard LVDS port (the display 1 type) can be activated from BIOS by selecting the [CRT+LFP] or [LFP] and the display connected to the ADD2-LVDS card (the display 2 type) can not be activated from BIOS, only via Intel Graphics Media Accelerator Driver.

In BIOS select:

Chipset > NorthBridge Chipset Configuration > Video Function Configuration >  
Boot Type = [CRT+LFP] or [LFP] or [CRT]  
Backlight Signal Inversion = [Disabled] or [Enabled]  
LCDVCC Voltage = [3.3V] or [5V]  
LVDS = [select display 1 (LFP) type no.]  
SDVO = [select display 2 type no.]

By selecting Secure CMOS (or OEM Failsafe) it is possible to prevent Windows from changing the BIOS "Boot Type" setting. For Windows use the Intel Graphics Media Driver version 6.14.10.4859 (win2K\_xp1431.exe) or newer. Clone mode is not supported in dual LVDS application.

## Electrical Specification

### Power consumption:

3.3V 3.5W/1.8W max. (Dual/Single and without possible 3.3V load for display).  
Available 3.3V for display: 1A max. for each display  
Available 5V for display: 1A max. for each display when PWR connected  
Available 12V for display: 2.2A max. for each inverter (without PWR total for both inverters is 4A).

**Operating temperature:** 0-60°C

## Appendix: How to remove LVDS connector

Removing the LVDS Cable/Connector used in different types of LVDS Cable Kits like 821517, can easily damage the LVDS connector if it's not done carefully, like just pulling the cable.

The best way to remove the connector is to pull the cable, but with only light force and at the same time move the cable from side to side, meaning from 45° to 90° position compared to normally 0°. See pictures below.

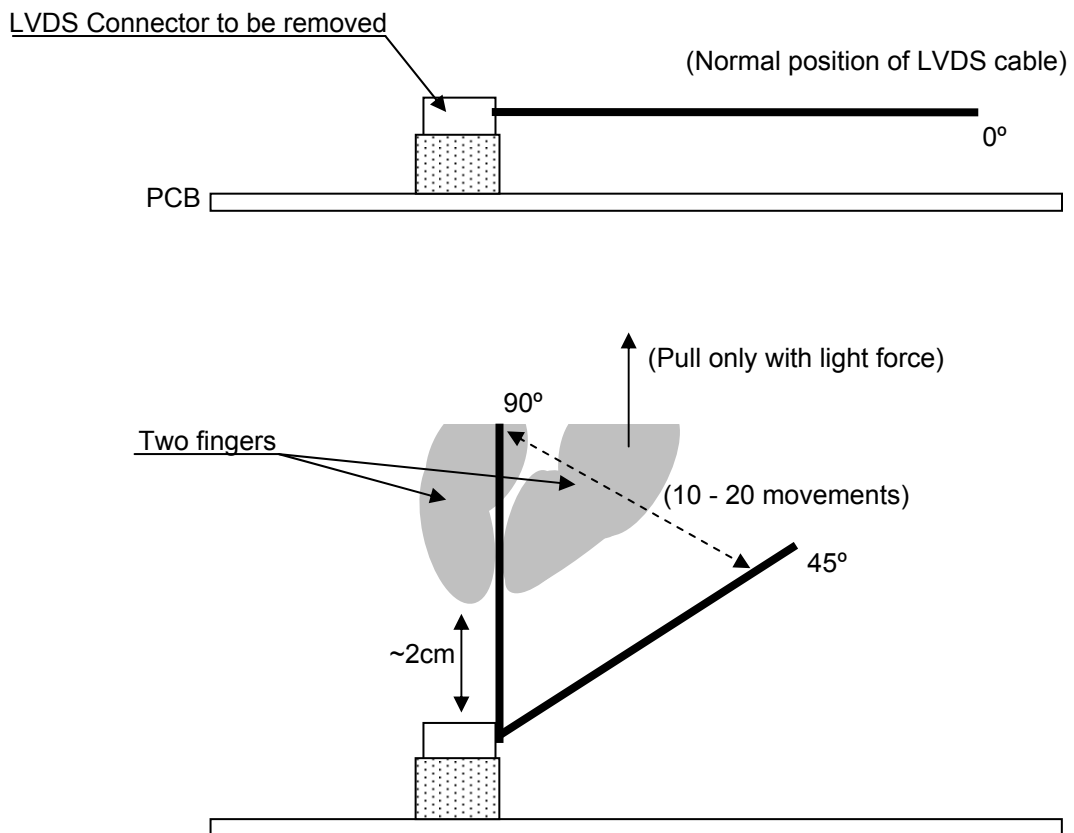

Hold the cable by 2 fingers in a position something like 2 cm from the connector and start moving the cable as described above. After something like 10-20 movements the connector will normally be released. When the connector starts to get loose be extra careful.

By this method the LVDS Cable/Connector can be disconnected hundred of times without being damaged.

## Appendix: The 820971 LDI Evaluation Kit

Consist of: 68700000 LDI (Large Display Interface) module  
 821521 Evaluation Cable Kit  
 821517 LVDS Cable 2x40p conn 405 mm

The CON1 on the 821521 is based on JAE FI-X30H display connector. As an option it is possible to replace the FI-X30H housing with a FI-E30H housing (using same terminals) and then add support for more displays. By manually moving the CON1 terminals it is possible to support many different displays.

### Items

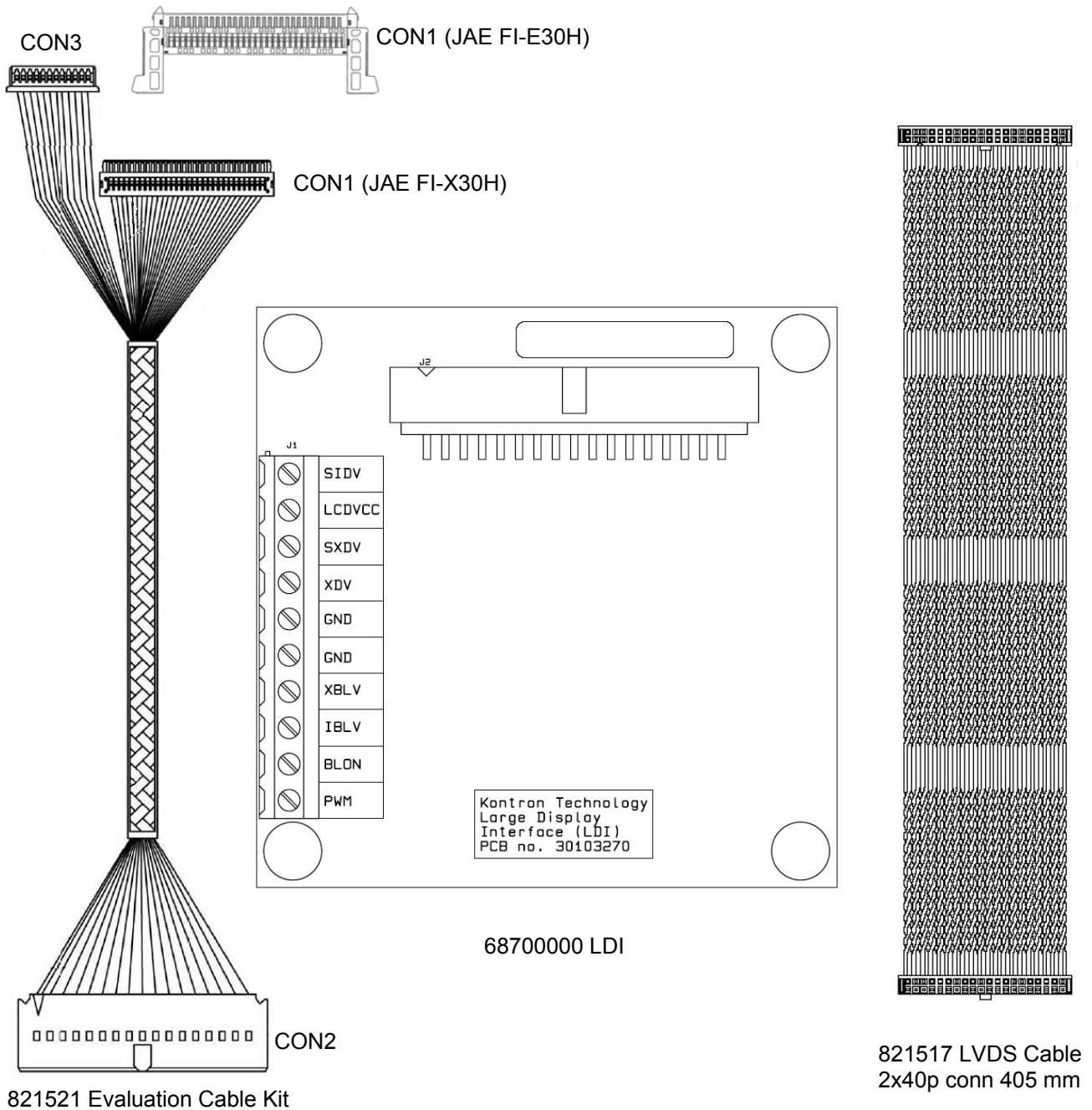



## Examples of Supported Displays and Inverters using LDI Evaluation Kit

Using JAE FI-X30H:

Display type
AUO M170EG01
AUO M190EG01
AUO M190EG02
Boe Hydis HT17E12-200
Fujitsu FLC48SXC8V-11AA
LG.Philips LM170E01
Samsung LTM170E5-L03
Samsung LTM170E6-L02
Samsung LTM181E4-L01
Sharp LQ170E1LG11
Sharp LQ190E1LW01
Samsung LTM201U1-L01
Samsung LTM170EH-L01
Samsung LTM170EU-L21
LG.Philips LM201U03
LG.Philips LM201U04

Using JAE FI-E30H:

Display type
Samsung LTA230W1-L02
Samsung LTA320W2-L01
Samsung LTA320W2-L03
Samsung LTA460H2-L02
Samsung LTA460W2-L01
Samsung LTI460WT-L13
Samsung LTI460WT-L15

## Supported Inverters

Inverter type
Samsung SIC241T
INT IT20166A
PIS AT-0170SS
Frontek FIF1942-32D
Frontek FIF1742-45A
Frontek FIF1742-57B
Green GCTT027
GH027
Frontek FIF2066-31A
Fujitsu FLCV-13
Microsemi LXM 1643 12-62
Frontek FIF1542-02A