

# » Kontron User's Guide «

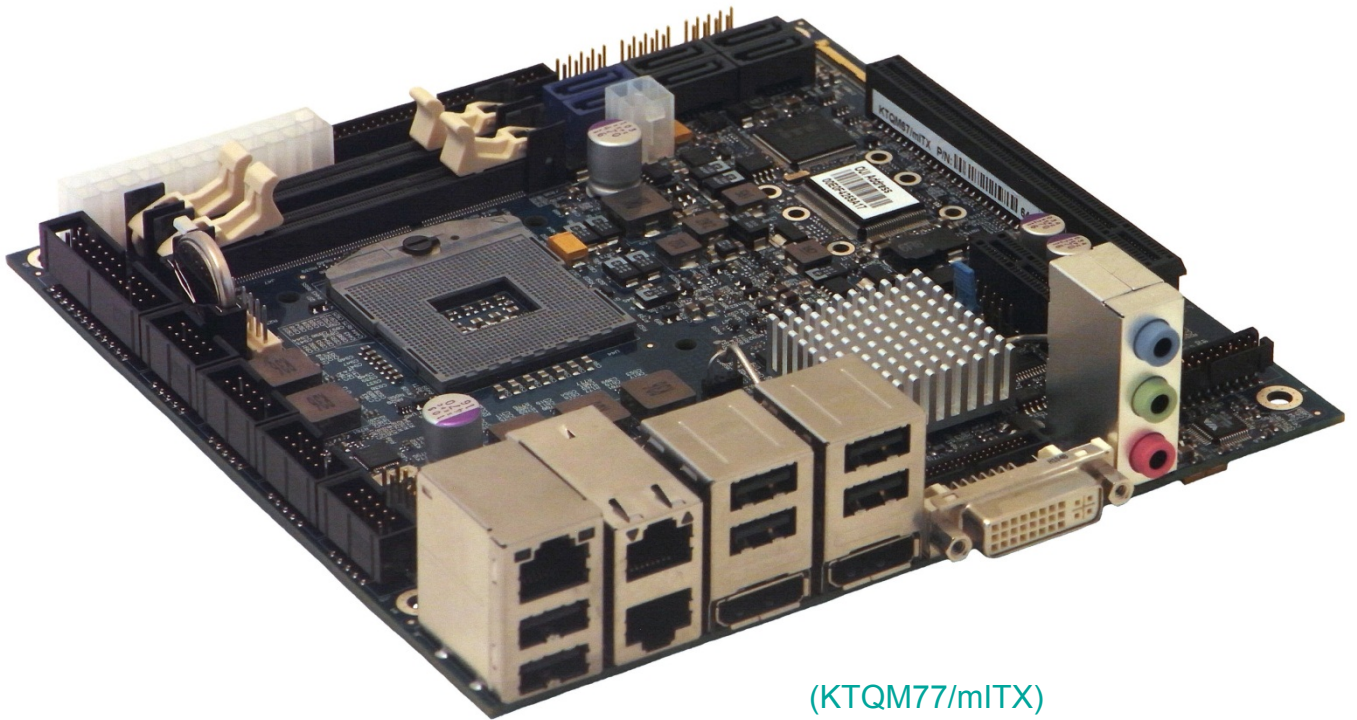

(KTQM77/mITX)

## KTQM77/mITX – KTHM76/mITX Users Guide

KTD-N0850-H

## Document revision history.

Revision	Date	By	Comment
H	04/2016	GSZ	New memory SKU
G		MLA	Chapter 7.1 Removed incorrect info. Correction of USB 5V protection info. Correction to Mic2 Line2 location. DVI pin 8 correction. EXT_BAT max. 3.47 V.
F	Jan 2 <sup>nd</sup> 2014	MLA	CPU list revised. BIOS part upgraded in according to BIOS Revision Release note (KTQM7715.bin). Added KTHM76/mITX.
E	Jun13th 2013	MLA	Minor corrections.
D	June 4 <sup>th</sup> 2013	MLA	Correction to AMT 8.0. Updated CPU list and RAM List. Several corrections.
C	May 27 <sup>th</sup> 2013	MLA	Added AMT short description. Correction to eDP and LVDS text. BIOS Recover text upgraded. Added note for PCIe2 support. BIOS information upgraded to BIOS 14.
B	Mar. 6 <sup>th</sup> 2013	MLA	Page 67 corrected function name. Added to BIOS section: System Temperature Ext Type and Fan limits. Added cable kits. Corrected PCIe1 signals. Note on OS installation via USB.
A	Feb. 19 <sup>th</sup> 2013	MLA	Removed 5V tolerance for some GPIO's. Jumper J37 info changed. 3.3V now 5% tolerance. Improved 12V only description. Updated CPU list. Revision of BIOS section. Completed System Resources.
0	July 10 <sup>th</sup> 2012	MLA	Preliminary version

## Copyright Notice:

Copyright © 2011, KONTRON Technology A/S, ALL RIGHTS RESERVED.

No part of this document may be reproduced or transmitted in any form or by any means, electronically or mechanically, for any purpose, without the express written permission of KONTRON Technology A/S.

## Trademark Acknowledgement:

Brand and product names are trademarks or registered trademarks of their respective owners.

## Disclaimer:

KONTRON Technology A/S reserves the right to make changes, without notice, to any product, including circuits and/or software described or contained in this manual in order to improve design and/or performance.

Specifications listed in this manual are subject to change without notice. KONTRON Technology assumes no responsibility or liability for the use of the described product(s), conveys no license or title under any patent, copyright, or mask work rights to these products, and makes no representations or warranties that these products are free from patent, copyright, or mask work right infringement, unless otherwise specified. Applications that are described in this manual are for illustration purposes only. KONTRON Technology A/S makes no representation or warranty that such application will be suitable for the specified use without further testing or modification.

## Life Support Policy

KONTRON Technology's PRODUCTS ARE NOT FOR USE AS CRITICAL COMPONENTS IN LIFE SUPPORT DEVICES OR SYSTEMS WITHOUT EXPRESS WRITTEN APPROVAL OF THE GENERAL MANAGER OF KONTRON Technology A/S.

As used herein:

Life support devices or systems are devices or systems which, (a) are intended for surgical implant into body, or (b) support or sustain life and whose failure to perform, when properly used in accordance with instructions for use provided in the labelling, can be reasonably expected to result in significant injury to the user.

A critical component is any component of a life support device or system whose failure to perform can be reasonably expected to cause the failure of the life support device or system, or to affect its safety or effectiveness.



# KONTRON Technology Technical Support and Services

If you have questions about installing or using your KONTRON Technology Product, check this User's Manual first – you will find answers to most questions here. To obtain support, please contact your local Distributor or Field Application Engineer (FAE).

**Before Contacting Support:** Please be prepared to provide as much information as possible:

- CPU Board
  1. Type.
  2. Part Number (find PN on label)
  3. Serial Number if available (find SN on label)
- Configuration
  1. CPU Type, Clock speed
  2. DRAM Type and Size.
  3. BIOS Revision (Find the Version Info in the BIOS Setup).
  4. BIOS Settings different than *Default* Settings (Refer to the BIOS Setup Section).
- System
  1. O/S Make and Version.
  2. Driver Version numbers (Graphics, Network, and Audio).
  3. Attached Hardware: Harddisks, CD-rom, LCD Panels etc.

## Warranty

KONTRON Technology warrants its products to be free from defects in material and workmanship during the warranty period. If a product proves to be defective in material or workmanship during the warranty period, KONTRON Technology will, at its sole option, repair or replace the product with a similar product.

Replacement Product or parts may include remanufactured or refurbished parts or components.

**The warranty does not cover:**

1. Damage, deterioration or malfunction resulting from:
  - A. Accident, misuse, neglect, fire, water, lightning, or other acts of nature, unauthorized product modification, or failure to follow instructions supplied with the product.
  - B. Repair or attempted repair by anyone not authorized by KONTRON Technology.
  - C. Causes external to the product, such as electric power fluctuations or failure.
  - D. Normal wear and tear.
  - E. Any other causes which does not relate to a product defect.
2. Removal, installation, and set-up service charges.

**Exclusion of damages:**

KONTRON TECHNOLOGY LIABILITY IS LIMITED TO THE COST OF REPAIR OR REPLACEMENT OF THE PRODUCT. KONTRON TECHNOLOGY SHALL NOT BE LIABLE FOR:

1. DAMAGE TO OTHER PROPERTY CAUSED BY ANY DEFECTS IN THE PRODUCT, DAMAGES BASED UPON INCONVENIENCE, LOSS OF USE OF THE PRODUCT, LOSS OF TIME, LOSS OF PROFITS, LOSS OF BUSINESS OPPORTUNITY, LOSS OF GOODWILL, INTERFERENCE WITH BUSINESS RELATIONSHIPS, OR OTHER COMMERCIAL LOSS, EVEN IF ADVISED OF THEIR POSSIBILITY OF SUCH DAMAGES.
2. ANY OTHER DAMAGES, WHETHER INCIDENTAL, CONSEQUENTIAL OR OTHERWISE.
3. ANY CLAIM AGAINST THE CUSTOMER BY ANY OTHER PARTY.

# Contents

## Contents

<b>Introduction</b> .....	<b>8</b>
<b>1 Installation procedure</b> .....	<b>9</b>
1.1 Installing the board .....	9
1.2 Requirement according to IEC60950 .....	10
<b>2 System Specification</b> .....	<b>11</b>
2.1 Component main data .....	11
2.2 System overview .....	15
2.3 Processor Support Table .....	17
2.4 System Memory support.....	19
2.5 Graphics Subsystem .....	20
2.5.1 Intel HD Graphics 4000 .....	20
2.5.2 Intel HD Graphics 3000 .....	20
2.5.3 LVDS and DVI .....	21
2.5.4 Graphics Adapters .....	21
2.6 Power Consumption .....	22
<b>3 Connector Locations</b> .....	<b>28</b>
3.1 Frontside .....	28
3.2 IO Bracket area .....	29
3.3 Backside .....	29
<b>4 Connector Definitions</b> .....	<b>30</b>
<b>5 IO-Area Connectors</b> .....	<b>31</b>
5.1 Display connectors (IO Area).....	31
5.1.1 DVI Connector (DVI-I) (J41) .....	31
5.1.2 DP Connectors (DP0/DP1) (J40/J39) .....	32
5.2 Ethernet Connectors .....	33
5.3 USB Connectors (IO Area) .....	34
5.3.1 USB Connector 0/1 (USB0/1) .....	35
5.3.2 USB Connector 2/3 (USB2/3) .....	36
5.3.3 USB Connector 4/5 (USB4/5) .....	36
5.4 Audio Connector (IO Area).....	37
<b>6 Internal Connectors</b> .....	<b>38</b>
6.1 Power Connector (ATX/BTXPWR) .....	38
6.2 Fan Connectors (FAN_CPU) (J28) and (FAN_SYS) (J29) .....	39
6.3 PS/2 Keyboard and Mouse connector (KBDMSE) (J27).....	40
6.4 Display connectors (Internal).....	41
6.4.1 eDP connector (EDP) (J38) .....	41
6.4.2 LVDS Flat Panel Connector (LVDS) (J20).....	42

6.5	SATA (Serial ATA) Disk interface (J21 – J26)	43
6.6	USB Connectors (USB)	44
6.6.1	USB Connector 6/7	44
6.6.2	USB Connector 8/9 (USB8/9) (J10)	44
6.6.3	USB Connector 10/11 (USB10/11) (J11)	45
6.6.4	USB Connector 12/13 (USB12/13) (J12)	45
6.7	Firewire/IEEE1394 connectors (J13,J14)	46
6.7.1	IEEE1394 connector (IEEE1394_0) (J14)	46
6.7.2	IEEE1394 connector (IEEE1394_1) (J13)	46
6.8	Serial COM1 – COM4 Ports (J15, J16, J17, J18)	47
6.9	Audio Connectors	48
6.9.1	CDROM Audio Input (CDROM) (J3)	48
6.9.2	Line2 and Mic2	48
6.9.3	Audio Header Connector (AUDIO_HEAD) (J31)	49
6.9.4	Front Panel Connector (FRONTPNL) (J19)	50
6.10	Feature Connector (FEATURE) (J30)	51
6.11	“Load Default BIOS Settings” Jumper (J37)	54
6.12	SPI Recover Jumper (J4)	55
6.13	SPI Connector (SPI) (J5)	56
6.14	XDP-CPU (Debug Port for CPU) (J32)	57
6.15	XDP-PCH (Debug Port for Chipset) (J33)	58
<b>7</b>	<b>Slot Connectors (PCIe, miniPCIe, PCI)</b>	<b>59</b>
7.1	PCIe Connectors	59
7.1.1	PCI-Express x16 Connector (PCIe x16)	59
7.1.2	miniPCI-Express mPCIe0 (J34)	61
7.1.3	miniPCI-Express mPCIe1 (J35)	62
7.1.4	PCI-Express x1 Connector (PCIe x1) (J36)	63
<b>8</b>	<b>On-board - &amp; mating connector types</b>	<b>64</b>
<b>9</b>	<b>System Resources</b>	<b>65</b>
9.1	Memory Map	65
9.3	Interrupt Usage	66
9.4	IO Map	67
<b>10</b>	<b>BIOS</b>	<b>68</b>
10.1	Main	68
10.2	Advanced	69
10.2.1	Advanced - PCI Subsystem Settings	70
10.2.2	Advanced - APCI Settings	73
10.2.3	Advanced - Trusted Computing	74
10.2.4	Advanced - CPU Configuration	75
10.2.5	Advanced - SATA Configuration	77
10.2.6	Advanced - Intel TXT (LT) Configuration	81
10.2.7	Advanced - AMT Configuration	82
10.2.8	Advanced - Acoustic Management Configuration	84
10.2.9	Advanced - USB Configuration	85
10.2.10	Advanced - SMART Settings	87
10.2.11	Advanced - Super IO Configuration	88
10.2.12	Advanced - Voltage Monitor	94
10.2.13	Advanced - Hardware Health Configuration	95
10.2.14	Advanced - Displayblock Setup	97
10.2.15	Advanced - LAN Configuration	98

10.2.16 Advanced - Delay Startup .....	100
10.2.17 Advanced - Serial Port Console Redirection .....	101
10.2.18 Advanced - CPU PPM Configuration.....	105
10.3 Chipset.....	107
10.3.1 PCH-IO Configuration.....	108
10.3.2 System Agent (SA) Configuration .....	114
10.4 Boot.....	131
10.4.1 Force Boot Setup .....	133
10.4.2 CSM parameters.....	134
10.5 Security.....	135
10.5.1 Image Execution Policy .....	136
10.5.2 Key Management.....	137
10.5.3 HDD Security Configuration .....	138
10.6 Save & Exit.....	139
<b>11 AMI BIOS Beep Codes .....</b>	<b>140</b>
<b>12 OS Setup .....</b>	<b>141</b>

## Introduction

This manual describes the KTQM77 family consisting of the KTQM77/mITX and the KTHM76/mITX boards made by KONTRON Technology A/S. In this Users Guide the boards will in general also be denoted KTQM77 and KTHM76 and if a subject is not depending on exact board type then both types of board will be denoted KTQM77.

The KTQM77 and KTHM76 boards are based on the QM77 and HM76 chipset respectively and support 3<sup>rd</sup> generation Intel® i7 -, i5 -, i3 2Core and 4Core mobile processors. See "Processor Support Table for more specific details.

The KTQM77 family consist on members having same form factors, and the same functionality except for the functions listed in the table below.

KTQM77 variants	LAN	IEEE 1394a	RAID	AMT	eDP	PCIe x16 Bifurcation	USB
KTQM77/mITX	3x	2x	0/1/5/10	AMT8.0	Yes	Yes	4x USB3.0/2.0 10x USB2.0
KTHM76/mITX	1x	No	No	No	No	No	4x USB3.0/2.0 8x USB2.0

Use of this Users Guide implies a basic knowledge of PC-AT hard- and software. This manual is focused on describing the KTQM77 board's special features and is not intended to be a standard PC-AT textbook.

New users are recommended to study the short installation procedure stated in the following chapter before switching-on the power.

All configuration and setup of the CPU board is either done automatically or manually by the user via the BIOS setup menus. Only exception is the "Load Default BIOS Settings" Jumper.



# 1 Installation procedure

## 1.1 Installing the board

To get the board running, follow these steps. If the board shipped from KONTRON has already components like RAM, CPU and cooler mounted, then relevant steps below, can be skipped.

### 1. Turn off the PSU (Power Supply Unit)



**Warning:** Turn off PSU (Power Supply Unit) completely (no mains power connected to the PSU) or leave the Power Connectors unconnected while configuring the board. Otherwise components (RAM, LAN cards etc.) might get damaged. If not using single 12V power input make sure PSU has 3.3V monitoring watchdog (standard ATX PSU feature), running the board without 3.3V will damage the board within minutes.

### 2. Insert the DDR3 DIMM 204pin SODIMM module(s)

Be careful to push it in the slot(s) before locking the tabs. For a list of approved DDR3 SODIMMs contact your Distributor or FAE. See also chapter "System Memory Support".

### 3. Install the processor

The CPU is keyed and will only mount in the CPU socket in one way. Use suitable screwdriver to open/ close the CPU socket. Refer to supported processor overview for details.

### 4. Cooler Installation

Use heat paste or adhesive pads between CPU and cooler and connect the Fan electrically to the FAN\_CPU connector.

### 5. Connecting Interfaces

Insert all external cables for hard disk, keyboard etc. A monitor must be connected in order to be able change BIOS settings.

### 6. Connect and turn on PSU

Connect PSU to the board by the ATX/BTXPWR and the 4-pin ATX+12V connectors. For the KTQM77/mITX alternatively use only the 4-pin ATX+12V connector if single voltage operation (+12V +/-5%) is requested.

### 7. Power Button

Depending on BIOS setting, the PWRBTN\_IN must be toggled to start the Power supply; this is done by shorting pins 16 (PWRBTN\_IN) and pin 18 (GND) on the FRONTPNL connector (see Connector description). A "normally open" switch can be connected via the FRONTPNL connector.

### 8. BIOS Setup

Enter the BIOS setup by pressing the <Del> key during boot up.

Enter Exit Menu and Load Optimal Defaults.

Refer to the "BIOS Configuration / Setup" section of this manual for details on BIOS setup.

**Note:** To clear all BIOS settings, including Password protection, activate "Load Default BIOS Settings" Jumper for ~10 sec (without power connected).

### 9. Mounting the board to chassis



**Warning:** When mounting the board to chassis etc. please notice that the board contains components on both sides of the PCB which can easily be damaged if board is handled without reasonable care. A damaged component can result in malfunction or no function at all.

When fixing the Motherboard on a chassis it is recommended using screws with integrated washer and having diameter of ~7mm.

**Note:** Do not use washers with teeth, as they can damage the PCB and may cause short circuits.

## 1.2 Requirement according to IEC60950

Users of KTQM77 should take care when designing chassis interface connectors in order to fulfil the IEC60950 standard:

When an interface/connector has a VCC (or other power) pin, which is directly connected to a power plane like the VCC plane:

To protect the external power lines of the peripheral devices, the customer has to take care about:

- That the wires have suitable rating to withstand the maximum available power.
- That the enclosure of the peripheral device fulfils the fire protecting requirements of IEC60950.

### Lithium Battery precautions:

<p style="text-align: center;"><b>CAUTION!</b></p> <p>Danger of explosion if battery is incorrectly replaced.</p> <p>Replace only with same or equivalent type recommended by manufacturer. Dispose of used batteries according to the manufacturer's instructions.</p>	<p style="text-align: center;"><b>VORSICHT!</b></p> <p>Explosionsgefahr bei unsachgemäßem Austausch der Batterie. Ersatz nur durch den selben oder einen vom Hersteller empfohlenen gleichwertigen Typ. Entsorgung gebrauchter Batterien nach Angaben des Herstellers.</p>
<p style="text-align: center;"><b>ADVARSEL!</b></p> <p>Lithiumbatteri – Eksplosionsfare ved fejlagtig håndtering. Udskiftning må kun ske med batteri af samme fabrikat og type. Levér det brugte batteri tilbage til leverandøren.</p>	<p style="text-align: center;"><b>ADVARSEL</b></p> <p>Eksplosjonsfare ved feilaktig skifte av batteri. Benytt samme batteritype eller en tilsvarende type anbefalt av apparatfabrikanten. Brukte batterier kasseres i henhold til fabrikantens instruksjoner.</p>
<p style="text-align: center;"><b>VARNING</b></p> <p>Explosionsfara vid felaktigt batteribyte. Använd samma batterityp eller en ekvivalent typ som rekommenderas av apparattillverkaren. Kassera använt batteri enligt fabrikantens instruktion.</p>	<p style="text-align: center;"><b>VAROITUS</b></p> <p>Paristo voi räjähtää, jos se on virheellisesti asennettu. Vaihda paristo ainoastaan laitevalmistajan suosittelemaan tyyppiin. Hävitä käytetty paristo valmistajan mukaisesti.</p>

## 2 System Specification

### 2.1 Component main data

The table below summarizes the features of the KTQM77/mITX embedded motherboard.

<b>Form factor</b>	KTQM77/mITX and KTHM76/mITX: minilTX (170,18 mm by 170,18 mm)
<b>Processor</b>	Support 2 <sup>nd</sup> and 3 <sup>rd</sup> Generation Intel® Core™ (Sandy Bridge M and Ivy Bridge M respectively) and Intel® Celeron® processors via Socket G2 (rPGA 988B ) ZIF Socket <ul style="list-style-type: none"> <li>Intel® Core™ i7</li> <li>Intel® Core™ i5</li> <li>Intel® Core™ i3</li> <li>Intel® Celeron® B810</li> </ul> Up to 1333MHz system bus and 2/3/4/6MB internal cache.
<b>Memory</b>	<ul style="list-style-type: none"> <li>DDR3 SODIMM 204pin socket (2 sockets)</li> <li>Support single and dual ranks DDR3 1066/1333/1600MT/s (PC3-8500/PC3-10600/PC3-12800)</li> <li>Support system memory from 256MB and up to 2x 8GB. Notes:Less than 4GB displayed in System Properties using 32bit OS (Shared Video Memory/PCI resources is subtracted)</li> <li>ECC not supported (PGA processors do not support ECC)</li> </ul>
<b>Chipset</b>	Intel QM77 /HM77 PCH (Platform Controller Hub) <ul style="list-style-type: none"> <li>Intel® VT-d (Virtualisation Technology for Directed I/O)</li> <li>Intel® TXT (Trusted Execution Technology)</li> <li>Intel® vPRO (KTQM77 only)</li> <li>Intel® AMT (Active Management Technology) version 8.0 (KTQM77 only)</li> <li>Intel® AT (Anti-Theft Technology)</li> <li>Intel® HD Audio Technology</li> <li>Intel® RST (Rapid Storage Technology)</li> <li>Intel® RRT (Rapid Recover Technology)</li> <li>SATA (Serial ATA) 6Gb/s and 3Gb/s.</li> <li>USB revision 2.0</li> <li>USB revision 3.0</li> <li>PCI Express revision 2.0</li> <li>ACPI 3.0b compliant</li> <li>Dual or Triple Display support (Dual/Triple Graphic Pipes, depends on CPU)</li> <li>Blue-ray HD video playback</li> </ul>
<b>Security</b>	<ul style="list-style-type: none"> <li>Intel® Integrated TPM 1.2 support</li> </ul>
<b>Management</b>	<ul style="list-style-type: none"> <li>Intel® Active Management Technology (Intel® AMT) 8.0 (KTQM77 only)</li> </ul>
<b>Audio</b>	Audio, 7.1 Channel High Definition Audio Codec using the VIA VT1708S codec <ul style="list-style-type: none"> <li>Line-out</li> <li>Line-in</li> <li>Surround output: SIDE, LFE, CEN, BACK and FRONT</li> <li>Microphone: MIC1 and MIC2</li> <li>CDROM in</li> <li>SPDIF (electrical Interface only)</li> <li>On-board speaker (Electromagnetic Sound Generator like Hycom HY-05LF)</li> </ul>

<b>Video</b>	<p>Intel i3, i5 &amp; i7 3<sup>rd</sup> Generation Mobile processors support Intel HD Graphics 4000. Intel i3, i5 &amp; i7 2<sup>nd</sup> Generation Mobile processor supports Intel HD Graphics 3000. Intel Celeron Processor B810 supports Intel HD Graphics.</p> <p>eDP (Embedded DisplayPort) directly from processor. (KTQM77 only). Analogue VGA and digital display ports (DVI, 2x DP, LVDS) via the Mobile Intel ® QM77 Chipset.</p> <ul style="list-style-type: none"> <li>• VGA (analogue panel) via DVI-I (sharing DVI-I connector with DVI-D)</li> <li>• DVI-D (sharing DVI-I connector with analogue VGA)</li> <li>• 2x DP (DisplayPorts), comply with DisplayPort 1.2 specification.</li> <li>• LVDS panel support up to 24 bit, 2 pixels/clock and 1920x1200.</li> <li>• HDMI panel support via DP to HDMI Adapter Converter.</li> <li>• Second VGA panel support via DP to VGA Adapter Converter.</li> <li>• Second DVI panel support via DP to DVI Adapter Converter.</li> <li>• Dual independent pipes for Mirror and Dual independent display support (exception is combination LVDS and eDP)</li> <li>• Triple independent pipes (Intel HD Graphics 4000 only) for triple independent or cloned displays are supported from OS. Any 3 displays via DP0, DP1, DVI-D or DVI-A, LVDS or eDP can be used, but only active DP to DVI/HDMI converters can be used.</li> </ul>
<b>I/O Control</b>	Via ITE IT8516E Embedded Controller and Nuvoton W83627DHG I/O Controller (both via LPC Bus interface)
<b>Peripheral interfaces</b>	<ul style="list-style-type: none"> <li>• Two USB 2.0 ports on I/O area</li> <li>• Four USB 3.0 / USB 2.0 on I/O area</li> <li>• Eight USB 2.0 ports on internal pinrows (KTQM77 only)</li> <li>• Six USB 2.0 ports on internal pinrows (KTHM76 only)</li> <li>• Two IEEE 1394a-2000 (up to 400M bits/s) on internal pinrows (KTQM77 only)</li> <li>• Four Serial ports (RS232) on internal pinrows</li> <li>• Two Serial ATA-600 IDE interfaces</li> <li>• Four Serial ATA-300 IDE interfaces</li> <li>• RAID 0/1/5/10 support (KTQM77 only)</li> <li>• mSATA via mPCIe_0 connector</li> <li>• PS/2 keyboard and mouse ports via pinrow</li> </ul>
<b>LAN Support</b>	<ul style="list-style-type: none"> <li>• 1x 10/100/1000Mbps/s LAN (ETHER1) using Intel® Lewisville 82579LM Gigabit PHY connected to QM77 supporting AMT 8.0 (AMT only on KTQM77)</li> <li>• 2x 10/100/1000Mbps/s LAN (ETHER2/ETHER3) using Intel® Hartwell 82574L PCI Express controllers (KTQM77 only)</li> <li>• PXE Netboot supported.</li> <li>• Wake On LAN (WOL) supported</li> </ul>
<b>Expansion Capabilities</b>	<ul style="list-style-type: none"> <li>• PCI-Express slot(s): <ul style="list-style-type: none"> <li>○ 1 slot PCIe x16 (PCIe 2.0 and up to PCIe 3.0 when using Ivy Bridge CPU)</li> <li>○ 1 slot PCIe x1 (PCIe 2.0):</li> <li>○ 1 slot miniPCI-Express (PCI Express or mSATA signals, no USB signals)</li> <li>○ 1 slot miniPCI-Express (PCI Express signals, no mSATA or USB signals)</li> </ul> </li> <li>• SMBus, compatible with ACCES BUS and I2C BUS, (via Feature connector)</li> <li>• SPI bus routed to SPI connector</li> <li>• DDC Bus routed to DVI-I connector</li> <li>• 18 x GPIOs (General Purpose I/Os), (via Feature connector)</li> <li>• DAC, ADC, PWM and TIMER (Multiplexed), (via Feature connector)</li> <li>• WAKE UP / Interrupt Inputs (Multiplexed), (via Feature connector)</li> <li>• 3 Wire Bus for GPIO Expansion (up to 152 GPIOs), (via Feature connector)</li> <li>• 8 bit Timer output, (via Feature connector)</li> </ul>

<b>Hardware Monitor Subsystem</b>	<ul style="list-style-type: none"> <li>• Smart Fan control system, support Thermal® and Speed® cruise for two on-board Fan connectors: CPU Fan (on-board) and System Fan (on-board)</li> <li>• Smart Fan control system, support Speed® cruise for two off-board Fans (Fan3/Fan4) via Feature Connector.</li> <li>• Three thermal inputs: CPU Die temperature (precision +/- 3°C), System temperature (precision +/- 3°C) and System Temperature External via Feature Connector (precision +/- 1°C).</li> <li>• Voltage monitoring</li> <li>• Intrusion (Case Open) detect input, (via Feature connector)</li> <li>• Sleep S5# Indication, (via Feature connector)</li> <li>• System Powergood Signal, (via Feature connector)</li> </ul>
<b>Power Supply Unit</b>	<p>ATX/BTX (w. ATX+12V) PSU for full PCI/PCIe load.  Alternatively (mITX version only): +12V single supply via ATX+12V (4-pole) connector, but with limitation to power load (especially +5V for USB).</p>
<b>Battery</b>	<p>Exchangeable 3.0V Lithium battery for on-board Real Time Clock and CMOS RAM. Manufacturer Panasonic / Part-number CR-2032L/BN, CR2032N/BN or CR-2032L/BE. Approximate 6.2 years retention.  Current draw is 4.1µA when PSU is disconnected and 0 µA in S0 – S5.</p> <p><b>CAUTION: Danger of explosion if the battery is incorrectly replaced. Replace only with the same or equivalent type recommended by the manufacturer. Dispose of used batteries according to the manufacturer’s instructions.</b></p>
<b>BIOS</b>	<ul style="list-style-type: none"> <li>• Kontron Technology / AMI BIOS (EFI core version)</li> <li>• Support for ACPI 3.0 ( Advanced Configuration and Power Interface), Plug &amp; Play <ul style="list-style-type: none"> <li>○ Suspend (S1 mode)</li> <li>○ Suspend To Ram (S3 mode)</li> <li>○ Suspend To Disk (S4 mode)</li> </ul> </li> <li>• “Always On” BIOS power setting</li> <li>• RAID Support (RAID modes 0,1, 5 and 10) KTQM77/mITX only</li> <li>•</li> </ul>
<b>Operating Systems Support</b>	<ul style="list-style-type: none"> <li>• WinXP (32b + 64b *)</li> <li>• Vista (32b * + 64b *)</li> <li>• Windows 7 (32b + 64b *)</li> <li>• Linux</li> <li>• VxWorks</li> <li>• Windows Server 2003 r2 (32b * + 64b *)</li> <li>• Windows Server 2008 r2 (32b * + 64b *)</li> <li>• WES7 (32b + 64b)</li> </ul> <p>*= Out Of The Box installation test only.</p>

<b>Environmental Conditions</b>	<p><b>Operating:</b> 0°C – 60°C operating temperature (forced cooling). It is the customer's responsibility to provide sufficient airflow around each of the components to keep them within allowed temperature range.</p> <p>10% - 90% relative humidity (non-condensing)</p> <p><b>Storage:</b> -20°C – 70°C; lower limit of storage temperature is defined by specification restriction of on-board CR2032 battery. Board with battery has been verified for storage temperature down to -40°C by Kontron.</p> <p>5% - 95% relative humidity (non-condensing)</p> <p><b>Electro Static Discharge (ESD) / Radiated Emissions (EMI):</b> All Peripheral interfaces intended for connection to external equipment are ESD/EMI protected. EN 61000-4-2:2000 ESD Immunity EN55022:1998 class B Generic Emission Standard.</p> <p><b>Safety:</b> IEC 60950-1: 2005, 2<sup>nd</sup> Edition UL 60950-1 CSA C22.2 No. 60950-1 Product Category: Information Technology Equipment Including Electrical Business Equipment Product Category CCN: NWGQ2, NWGQ8 File number: E194252</p> <p><b>Theoretical MTBF:</b> 269.335 / 132.342 hours @ 40°C / 60°C for the KTQM77/mITX &gt;269.335 / &gt;132.342 hours @ 40°C / 60°C for the KTHM76/mITX</p> <p><b>Restriction of Hazardous Substances (RoHS):</b> The KTQM77/mITX and KTHM76/mITX are RoHS compliant.</p> <p><b>Capacitor utilization:</b> No Tantalum capacitors on board Only Japanese brand Solid capacitors rated for 100 °C used on board</p>
---------------------------------	--

## 2.2 System overview

The block diagram below shows the architecture and main components of the KTQM77. The key component on the board is the Intel® QM77 (Panther Point) Mobile Express Chipset.

Some components (PCI slots) are optional depending on board type.

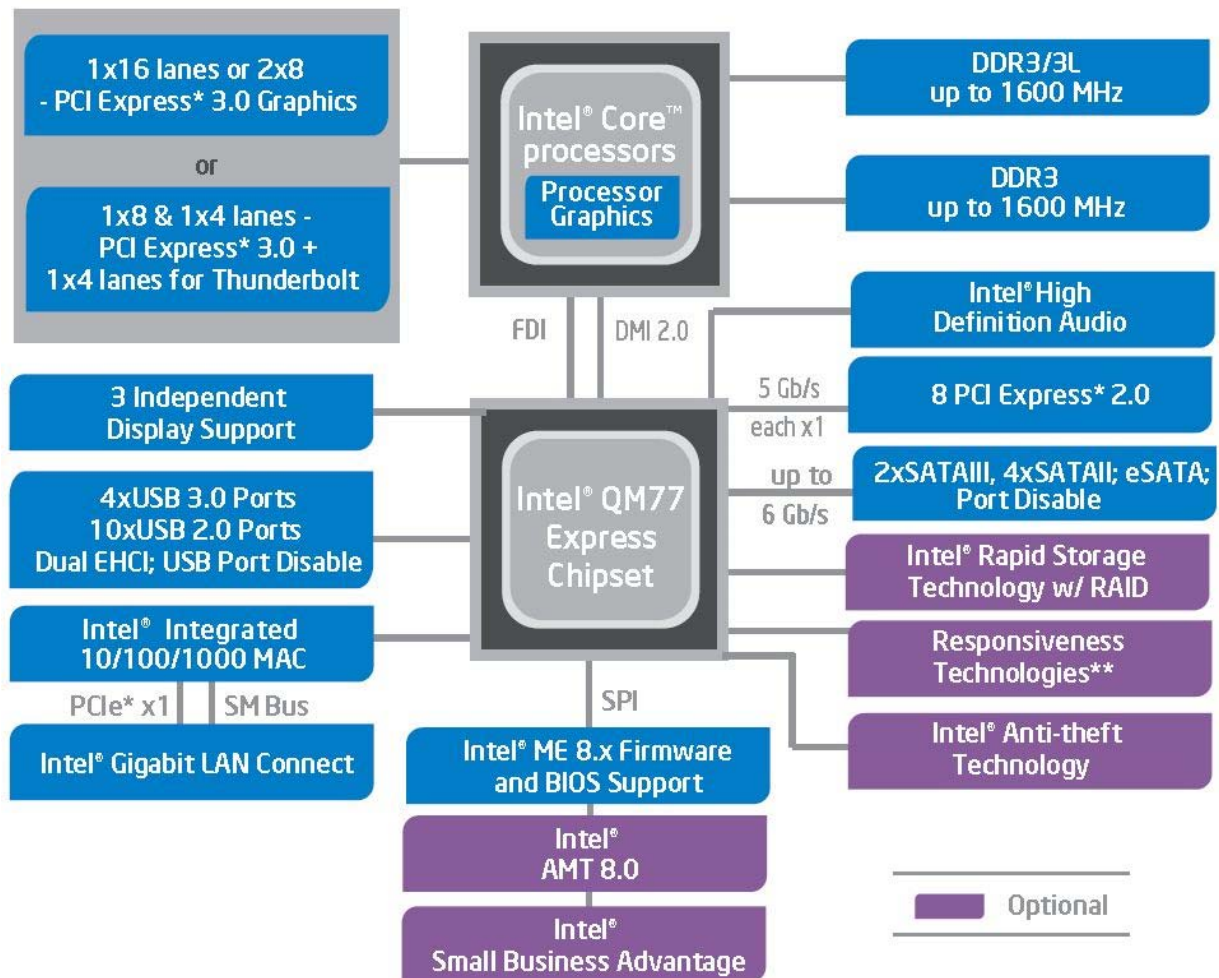

More detailed block diagram on next page.

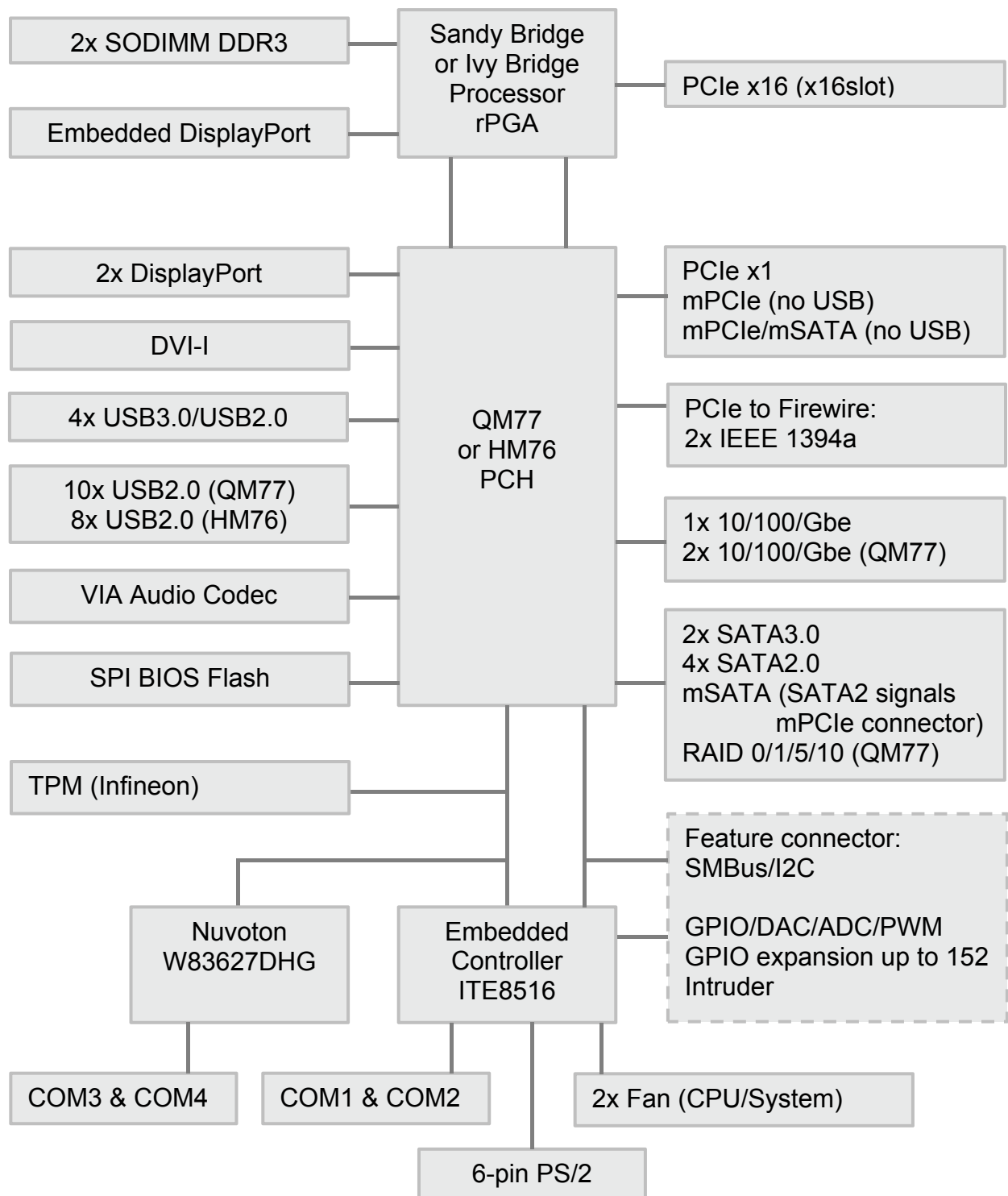



## 2.3 Processor Support Table

KTQM77 is designed to support the following PGA 988 processors (up to 55W power consumption):

**2<sup>nd</sup> / 3<sup>rd</sup> generation Intel® Core™ i7 processor**

**2<sup>nd</sup> / 3<sup>rd</sup> generation Intel® Core™ i5 processor**

**2<sup>nd</sup> / 3<sup>rd</sup> generation Intel® Core™ i3 processor**

**Intel® Celeron® processor**



In the following list you will find all CPU's supported by the chipset in according to Intel but also other CPU's if successfully tested.

Embedded CPU's are indicated by **green** text, successfully tested CPU's are indicated by **highlighted** text, successfully tested embedded CPU's are indicated by **green and highlighted** text and failed CPU's are indicated by **red** text.

Some processors in the list are distributed from Kontron, those CPU's are marked by an \* (asterisk). However please notice that this marking is only guide line and maybe not fully updated.

Processor Brand	Clock Speed	Turbo Speed	Cores	Threads	Bus Speed		Cache	CPU Number	sSpec number	Stepping	Thermal Design Power
	GHz	GHz			MHz	MB					°C/W
Core™ i7 3 <sup>rd</sup> gen.	3.0	3.7	2	4	1333/1600		4	3540M	SR0X6	L1	105/35
	2.9	3.6	2	4	1333/1600		4	3520M	SR0MU	L1	105/35
	2.8	3.8	4	8	1333/1600		8	3840QM	SR0UT	E1	105/45
	2.7	3.7	4	8	1333/1600		8	3820QM	SR0MK	E1	105/45
	2.7	3.7	4	8	1333/1600		6	3740QM	SR0UV	E1	105/45
	2.6	3.6	4	8	1333/1600		6	3720QM	SR0ML	E1	105/45
	2.4	3.4	4	6	1333/1600		6	3630QM	SR0UX	E1	105/45
	2.3	3.3	4	8	1333/1600		6	3610QM	SR0MN	E1	105/45
	<b>2.3</b>	<b>3.3</b>	<b>4</b>	<b>8</b>	<b>1333/1600</b>		<b>6</b>	<b>3610QE*</b>	<b>SR0NP</b>	<b>E1</b>	<b>105/45</b>
	2.2	3.2	4	8	1333/1600		6	3632QM	SR0V0	E1	105/35
2.1	3.1	4	8	1333/1600		6	3612QM	SR0MQ	E1	105/35	
Core™ i7 2 <sup>nd</sup> gen.	2.8	3.5	2	4	1066/1333		4	2640M	SR03R	J1	100/35
	2.7	3.4	2	4	1066/1333		4	2620M	SR03F	J1	100/35
	2.5	3.6	4	8	1066/1333/1600		8	2860QM	SR02X	D2	100/45
	2.5	3.5	4	8	1066/1333/1600		8	2920XM	SR02E	D2	100/55
	2.4	3.5	4	8	1066/1333/1600		6	2760QM	SR02W	D2	100/45
	2.3	3.4	4	8	1066/1333/1600		8	2820QM	SR012	D2	100/45
	2.2	3.1	4	8	1066/1333		6	2670QM	SR02N	D2	100/45
	<b>2.2</b>	<b>3.4</b>	<b>4</b>	<b>8</b>	<b>1066/1333/1600</b>		<b>6</b>	<b>2720QM</b>	<b>SR014</b>	<b>D2</b>	<b>100/45</b>
	<b>2.1</b>	<b>3.0</b>	<b>4</b>	<b>8</b>	<b>1066/1333/1600</b>		<b>6</b>	<b>2710QE*</b>	<b>SR02T</b>	<b>D2</b>	<b>100/45</b>
	2.0	2.9	4	8	1066/1333		6	2630QM	SR02Y	D2	100/45
Core™ i5 3 <sup>rd</sup> gen.	2.9	3.6	2	4	1333/1600		3	3380M	SR0X7	L1	105/35
	2.8	3.5	2	4	1333/1600		3	3360M	SR0MV	L1	105/35
	2.7	3.4	2	4	1333/1600		3	3340M	SR0XA	L1	105/35
	<b>2.7</b>	<b>3.3</b>	<b>2</b>	<b>4</b>	<b>1333/1600</b>		<b>3</b>	<b>3610ME*</b>	<b>SR0QJ</b>	<b>L1</b>	<b>105/35</b>
	2.6	3.3	2	4	1333/1600		3	3320M	SR0MX	L1	105/35
	2.6	3.2	2	4	1333/1600		3	3230M	SR0WY	L1	105/35
2.5	3.1	2	4	1333/1600		3	3210M	SR0MZ	L1	105/35	
Core™ i5 2 <sup>nd</sup> gen.	<b>2.6</b>	<b>3.3</b>	<b>2</b>	<b>4</b>	<b>1066/1333</b>		<b>3</b>	<b>2540M</b>	<b>SR044</b>	<b>J1</b>	<b>100/35</b>
	<b>2.5</b>	<b>3.2</b>	<b>2</b>	<b>4</b>	<b>1066/1333</b>		<b>3</b>	<b>2520M</b>	<b>SR048</b>	<b>J1</b>	<b>100/35</b>
	<b>2.5</b>	<b>3.1</b>	<b>2</b>	<b>4</b>	<b>1066/1333</b>		<b>3</b>	<b>2510E*</b>	<b>SR02U</b>	<b>D2</b>	<b>100/35</b>
	2.3	2.9	2	4	1066/1333		3	2410M	SR04B	J1	100/35

Processor Brand	Clock Speed	Turbo Speed	Cores	Threads	Bus Speed	Cache	CPU Number	sSpec number	Stepping	Thermal Design Power
	GHz	GHz			MHz	MB				°C/W
Core™ i3 3 <sup>rd</sup> gen.	2.6	-	2	4	1333/1600	3	3130M	SR0XC	L1	90/35
	2.5	-	2	4	1333/1600	3	3120M	SR0TX	L1	90/35
	<b>2.4</b>	-	<b>2</b>	<b>4</b>	<b>1333/1600</b>	<b>3</b>	<b>3120ME</b>	<b>SR0QM*</b>	<b>L1</b>	<b>105/35</b>
	2.4	-	2	4	1333/1600	3	3110M	SR0N2	L1	90/35
Core™ i3 2 <sup>nd</sup> gen.	2.4	-	2	4	1066/1333	3	2370M	SR0DP	J1	85/35
	2.3	-	2	4	1066/1333	3	2350M	SR0DN	J1	85/35
	<b>2.2</b>	-	<b>2</b>	<b>4</b>	<b>1066/1333</b>	<b>3</b>	<b>2330E</b>	<b>SR02V*</b>	<b>D2</b>	<b>100/35</b>
	2.2	-	2	4	1066/1333	3	2330M	SR04J	J1	85/35
	2.2	-	2	4	1066/1333	3	2328M	SR0TC	J1	85/35
	2.1	-	2	4	1066/1333	3	2312M	SR09S	J1	85/35
	2.1	-	2	4	1066/1333	3	2310M	SR04R	J1	85/35
	<b>1.6</b>	-	<b>2</b>	<b>2</b>	<b>1066/1333</b>	<b>2</b>	<b>B810</b>	<b>SR088*</b>	<b>Q0</b>	<b>100/35</b>
1.6	-	1	1	1066/1333	1.5	B710			100/35	

**Note:** Sufficient cooling must be applied to the CPU in order to remove the effect as listed in above table (Thermal Guideline). The sufficient cooling is also depending on the maximum (worst-case) ambient operating temperature and the actual load of processor.

The Kontron PN 1044-9447 is “Active Cooler for KTQM67/KTQM77” capable of being used for processors (fully loaded) having Thermal Guideline up to 45W @ 60°C ambient temperature. MTBF is 70.000 hours @ 40°C.

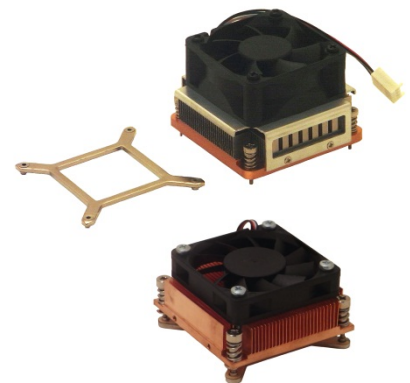

The Kontron PN 1052-6345 “Cooler Active KTQM67 35W 33mm longlife” is capable of being used for processors (fully loaded) having Thermal Guideline up to 35W @ 60°C ambient temperature. It support 1U and has long life (MTBF is 200.000 hours @ 60°C).

All the processors in the list above, inclusive the Celeron processor, are supporting the Enhanced Intel® SpeedStep® which is improved SpeedStep technology for faster transition between voltage (power saving states) and frequency states with the result of improved power/performance balance.

Intel® Turbo Boost Technology 2.0 is supported by i5 and i7, as indicated in above list of processors, and is enabling overclocking of all cores, when operated within the limits of thermal design power, temperature and current.

Intel® vPro Technology is supported by some of the i5 and i7 (not by Core i3) (KTQM77/mITX only).

Intel AMT (Active Management Technology) (supported by KTQM77/mITX only) is a part of vPRO and is hardware and firmware technology that builds certain functionality into business PCs in order to remotely monitor, maintain, update, upgrade, and repair PCs. Intel AMT relies on a hardware-based out-of-band (OOB) communication channel that operates below the OS level, the channel is independent of the state of the OS (present, missing, corrupted, down). The communication channel is also independent of the PC's power state (however standby power required), the presence of a management agent, and the state of many hardware components (such as hard disk drives and memory). AMT is not intended to be used by itself; it is intended to be used with a software management application based on 3rd party software. If AMT is not required then KTHM65/KTHM76 might be an alternative or AMT can be disabled in BIOS. For more information search for “AMT” on Intel Homepage.

PCIex2 is only supported on the PCIex16 slot if using 3<sup>rd</sup> Generation Core2 CPU's (Ivy Bridge).

## 2.4 System Memory support

The KTQM77 has two DDR3 SODIMM sockets. The sockets support the following memory features:

- 1.5V (only) 204-pin DDR3 SODIMM with gold-plated contacts
- Single/dual rank unbuffered DDR3 1333/1600MT/s (PC3-10600/PC3-12800)
- From 256MB and up to 2x 8GB. (up to 2x4GB tested)  
Notes: Less than 4GB displayed in System Properties using 32bit OS  
(Shared Video Memory/PCI resources is subtracted)
- SPD timings supported
- ECC not supported (PGA processors do not support ECC)

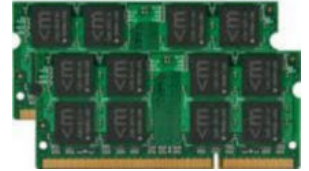

The installed DDR3 SODIMM should support the Serial Presence Detect (SPD) data structure. This allows the BIOS to read and configure the memory controller for optimal performance. If non-SPD memory is used, the BIOS will attempt to configure the memory settings, but performance and reliability may be impacted.

### Memory Operating Frequencies

Regardless of the SODIMM type used, the memory frequency will either be equal to or less than the processor system bus frequency. For example, if DDR3 1600 memory is used with a 1333 MHz system bus frequency processor, the memory clock will operate at 666 MHz. The table below lists the resulting operating memory frequencies based on the combination of SODIMMs and processors.

DIMM Type	Module name	Memory Data transfers	Processor system bus frequency	Resulting memory clock frequency	Peak transfer rate
		Mill/s	MHz	MHz	MB/s
DDR3 1333	PC3-10600	1333	1333 or more	666	10666
DDR3 1600	PC3-12800	1600	1333 max	666	10666
DDR3 1600	PC3-12800	1600	1600	800	12800

**Notes:** Kontron offers the following DDR3 204P SODIMM:

NEW SKU 04/2016*	SKU Name**	OLD SKU before 04/2016
1060-2512	DDR3-1333 SODIMM 2GB	1054-3781
1060-2518	DDR3-1333 SODIMM 2GB	1055-8136
1060-2514	DDR3-1333 SODIMM 4GB	1054-3782
1060-2516	DDR3-1333 SODIMM 8GB	1054-3783
1060-2506	DDR3-1600 SODIMM 1GB	1054-3776
1060-2482	DDR3-1600 SODIMM 2GB	1051-5403
1060-2484	DDR3-1600 SODIMM 4GB	1051-9057
1060-2504	DDR3-1600 SODIMM 8GB	1054-3775

\*SKU changes were caused by administrative issues only, no hardware changes.

\*\*Named are always the min. requirements, the shipped memory can fulfill a higher performance level

## 2.5 Graphics Subsystem

The KTQM77 equipped with Intel 3<sup>rd</sup> Gen i3, i5 or i7 processor, supports Intel HD Graphics 4000, equipped with Intel 2<sup>nd</sup> Gen i3, i5 or i7 processor the Intel HD Graphics 3000 is supported and equipped with Intel Celeron Processor B810 the Intel HD Graphics is supported.

The KTQM77/mITX support eDP (Embedded DisplayPort) directly from processor, and both KTQM77/mITX and KTHM76/mITX supports analogue VGA and digital display ports (DVI, 2x DP, LVDS) via the Mobile Intel Chipset (QM77 or HM76). The Analogue VGA and DVI-D are sharing the DVI-I connector.

The PCH supports High-bandwidth Digital Content Protection for high definition content playback over digital interfaces. The PCH also integrates audio codecs for audio support over DP interfaces.

Up to three displays (any of: DP0, DP1, DVI-D or DVI-A, LVDS or eDP (QM77 only)) can be activated at the same time and be used to implement independent or cloned display configuration. PCIe and PCI graphics cards can be used to replace on-board graphics or in combination with on-board graphics.

### 2.5.1 Intel HD Graphics 4000

Features of the Intel HD Graphics 4000 build into the i3, i5 and i7 processors, includes:

- High quality graphics engine supporting
  - DirectX11 and OpenGL 4.0 compliant
  - Shader Model 5.0 support
  - Intel® Clear Video HD Technology
  - Intel® Quick Sync Video Technology
  - Intel® Flexible Display Interface (Intel® FDI)
  - Core frequency of 650 - 1150 (Turbo) MHz
  - Memory Bandwidth up to 21.3 GB/s
  - 16 3D Execution Units
  - 1.62 GP/s and 2.7 GP/S pixel rate (eDP and DP outputs)
  - Hardware Acceleration CVT HD and QSV
  - Dynamic Video Memory Technology (DVMT) support up to 1720 MB
- eDP (Embedded DisplayPort on QM77) (Not in combination with LVDS)
- DP0 and DP1
  - 24/30 bit colours in WQXGA (2560x1600 pixels) and HDCP.
  - DisplayPort standard 1.2

### 2.5.2 Intel HD Graphics 3000

Features of the Intel HD Graphics 3000 build into the i3, i5 and i7 processors, includes:

- High quality graphics engine supporting
  - DirectX10.1 and OpenGL 3.0 compliant
  - Shader Model 4.1 support
  - Intel® Clear Video HD Technology
  - Intel® Quick Sync Video Technology
  - Intel® Flexible Display Interface (Intel® FDI)
  - Core frequency of 350 - 1300 (Turbo) MHz
  - Memory Bandwidth up to 21.3 GB/s
  - 12 3D Execution Units
  - 1.62 GP/s and 2.7 GP/S pixel rate (eDP and DP outputs)
  - Hardware Acceleration full MPEG2, full VC-1 and full AVC
  - Dynamic Video Memory Technology (DVMT) support up to 1720 MB
- eDP (Embedded DisplayPort on QM77) (Not in combination with LVDS)
- DP0 and DP1
  - 24/30 bit colours in WQXGA (2560x1600 pixels) and HDCP.
  - DisplayPort standard 1.1a

### 2.5.3 LVDS and DVI

- LVDS panel Support (optional), 18/24 bit colours in up to WUXGA (1920x1200) @60 Hz and SPWG (VESA) colour coding. OpenLDI (JEIDA) colour coding is 18 bit with or without Dithering. (Not in combination with eDP (QM77 only)).
- DVI-I (Digital Visual Interface)
  - Either DVI-A or DVI-D can be used via DVI-I connector
  - DVI-A Analogue Display (CRT)
    - 300 MHz Integrated 24-bit RAMDAC
    - Up to QXGA (2048x1536 pixels) @ 75 Hz refresh
  - DVI-D Digital Display up to WUXGA (1920x1200 pixels) @60 Hz

### 2.5.4 Graphics Adapters

Use of DP Adapter Converters can implement HDMI support or second VGA or DVI panel support.

The HDMI interface supports the HDMI 1.4a specification including audio codec. However limitations to the resolution apply: 2048x1536 (VGA), 1920x1200 (HDMI and DVI)



1051-7619 Cable DP Extender cable 200mm  
(when using two DP converters)



DP to VGA	DP to HDMI	DP to DVI-D
PN 1045-5779	PN 1045-5781	PN 1045-5780

Notice that only the DP to VGA adapter is an “active” converter the HDMI and DVI converters are passive and cannot be used in a triple panel configuration.

## 2.6 Power Consumption

In order to ensure safe operation of the board, the ATX12V power supply must monitor the supply voltage and shut down if the supplies are out of range – refer to the hardware manual for the actual power supply specification. Please note, In order to keep the power consumption to a minimal level, boards do not implement a guaranteed minimum load. In some cases, this can lead to compatibility problems with ATX power supplies, which require a minimum load to stay in regulation. The KTQM77/mITX board is powered through the ATX+12V (4-pole) connector and optionally also ATX/BTX (24-pole) connector.

**Single 12V supply:** When powered by 12V only (via ATX+12V connector) then limitations apply to +5V, where 14x USB, LVDS panel or eDP panel, COM ports, LPT port and Frontpanel connector shares 9.5A. 4-pole connector power limitation is 145W maximum, but if required more +12V power can be added via +12V (and GND) terminals in the 24-pin power connector. It is allowed to use the +12V and +5V from the 24-pole connector in order to drive external devices, but please notice that it is not allowed to use the SB5V, POK and PSON# signals.

**ATX12V supply:** When powered as standard ATX12V then both ATX+12V connector and ATX/BTX connector must be used in according to the ATX12V PSU standard.

**Warning:** Hot Plugging power supply is not supported. Hot plugging might damage the board.

The requirements to the supply voltages are as follows:

Supply	Min	Max	Note
VCC3.3	3.135V	3.465V	Should be $\pm 5\%$ for compliance with the ATX specification
Vcc	4.75V	5.25V	Should be $\pm 5\%$ for compliance with the ATX specification. Should be +5/ -0% to meet the USB standard.
+12V	11.4V	12.6V	Should be $\pm 5\%$ for compliance with the ATX specification
-12V	-13.2V	-10.8V	Should be $\pm 10\%$ for compliance with the ATX specification
-5V	-5.50V	-4.5V	Not required for the KTQM77 boards
5VSB	4.75V	5.25V	Should be $\pm 5\%$ for compliance with the ATX specification

### Total System power example **TBD**

CPU? @ ? GHz, ? GB Ram, 1x xxxgb HDD, 1x DVD-ROM, PSU

Operation	Power Supplied via	
	ATX + 12V	12V Only
Windows 7 32bit Idle	33W	36W
Windows 7 32bit 3Dmark 2003	70W-88W	72W-96W
Windows 7 32bit Intel Thermal Load	111W	111W

Note: Listed power consumptions are inclusive 15 - 25W for PSU, HDD and DVD.

### More detailed Static Power Consumption **TBD**

On the following pages the power consumption of different boards in different configurations are listed. For each configuration the power consumptions result are listed in 5 tables:

- 1- DOS, idle, mean
- 2- Windows7, Running 3DMARK 2005 & BiT 6, mean
- 3- S0, mean
- 4- S3, mean
- 5- S5, mean

Note: some S5 measurements have been carried out in two sub modes M3 and M0ff. Only S5/M3 mode maintains power to the circuits used for AMT and waking up the system via LAN, Keyboard and USB, while both S5/M3 and S5/M0ff maintain power to RTC, Power Button In circuit and CMOS data.

The principal test system and test equipment used **TBD**

1. Tektronix TDS5104B
2. Tektronix TCPA300
3. Tektronix TCP312
4. Fluke 289
5. Fluke 179
6. ATX rail switch

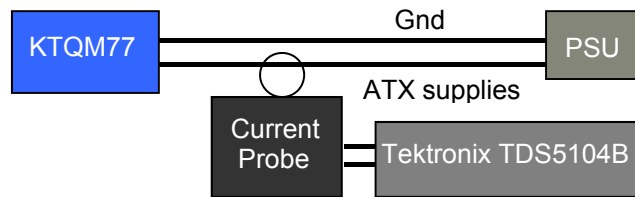

Note: Power consumption of PSU (power loss), Monitor and HDD are not included.

The following four configurations (a – d) have been tested **TBD**

**a) Low Power Setup KTQM77/mITX ATX+12V PSU**

**b) Low Power Setup KTQM77/mITX +12V only PSU**

Standard system configuration equipped with PCIe1 card, Internal graphics, 2x SATA disks, Intel i5 CPU, 1x SODIMM (1GB Modules), Monitor, Keyboard & Mouse. 1x 1-4GB USB Stick, 12V active cooler (KT), PSU (Corsair 430W)

**c) High Power Setup KTQM77/mITX ATX+12V PSU**

**d) High Power Setup KTQM77/mITX +12V only PSU**

Standard system configuration equipped with PCIe1, PCIe16, miniPCIe WLAN, 4x SATA disks, Intel i7 CPU, 2x SODIMM (1GB Modules), Monitor, Keyboard & Mouse, 4x 1-4GB USB Sticks, 12V active cooler (KT), PSU (Corsair 430W).

a) Low Power Setup KTQM77/mitX ATX+12V PSU **TBD**

DOS Idle, Mean, No external load		
Supply	Current draw [A]	Power consumption [W]
+12V	0,140	1,680
+12V P4	1,222	14,664
+5V	0,411	2,055
+3V3	0,557	1,838
-12V	0,035	0,42
5VSB	0,007	0,035
<b>Total</b>		<b>20,7</b>

Windows 7, mean 3DMARK2005 ( first scene ) & Bit 6		
Supply	Current draw [A]	Power consumption [W]
+12V	0,165	1,980
+12V P4	3,250	39,000
+5V	0,450	2,250
+3V3	0,577	1,904
-12V	0,046	0,552
5VSB	0,007	0,035
<b>Total</b>		<b>45,7</b>

S0 Mode, Mean, No external load		
Supply	Current draw [A]	Power consumption [W]
+12V	0,107	1,284
+12V P4	0,510	6,120
+5V	0,336	1,680
+3V3	0,576	1,901
-12V	0,043	0,516
5VSB	0,007	0,035
<b>Total</b>		<b>11,5</b>

S3 Mode, Mean, No external load		
Supply	Current draw [A]	Power consumption [W]
5VSB	0,218	1,090
<b>Total</b>		<b>1,09</b>

S5 Mode, Mean, No external load		
Supply	Current draw [A]	Power consumption [W]
5VSB	0,213	1,065
<b>Total</b>		<b>1,07</b>



b) Low Power Setup KTQM77/mITX +12V only PSU **TBD**

DOS Idle, Mean, No external load		
Supply	Current draw [A]	Power consumption [W]
+12V P4	1,721	20,652
<b>Total</b>		<b>20,7</b>

Windows 7, mean 3DMARK2005 ( first scene ) & BiT 6		
Supply	Current draw [A]	Power consumption [W]
+12V P4	3,940	47,28
<b>Total</b>		<b>47,3</b>

S0 Mode, Mean, No external load		
Supply	Current draw [A]	Power consumption [W]
+12V P4	0,992	11,904
<b>Total</b>		<b>11,9</b>

S3 Mode, Mean, No external load		
Supply	Current draw [A]	Power consumption [W]
+12V P4	0,099	1,188
<b>Total</b>		<b>1,19</b>

S5 Mode, Mean, No external load		
Supply	Current draw [A]	Power consumption [W]
+12V P4	0,098	1,176
<b>Total</b>		<b>1,18</b>

c) High Power Setup KTQM77/mitX ATX+12V PSU **TBD**

DOS Idle, Mean, No external load		
Supply	Current draw [A]	Power consumption [W]
+12V	0,932	11,184
+12V P4	1,102	13,224
+5V	0,452	2,260
+3V3	0,553	1,825
-12V	0,036	0,432
5VSB	0,007	0,035
<b>Total</b>		<b>29,0</b>

Windows 7, mean 3DMARK2005 ( first scene ) & BiT 6		
Supply	Current draw [A]	Power consumption [W]
+12V	1,355	16,260
+12V P4	4,663	55,956
+5V	0,474	2,370
+3V3	0,968	3,194
-12V	0,049	0,588
5VSB	0,007	0,035
<b>Total</b>		<b>78,4</b>

S0 Mode, Mean, No external load		
Supply	Current draw [A]	Power consumption [W]
+12V	0,569	6,828
+12V P4	0,485	5,820
+5V	0,420	2,100
+3V3	0,964	3,812
-12V	0,049	0,588
5VSB	0,007	0,035
<b>Total</b>		<b>18,6</b>

S3 Mode, Mean, No external load		
Supply	Current draw [A]	Power consumption [W]
5VSB	0,226	1,130
<b>Total</b>		<b>1,13</b>

S5 Mode, Mean, No external load		
Supply	Current draw [A]	Power consumption [W]
5VSB	0,219	1,095
<b>Total</b>		<b>1,10</b>

d) High Power Setup KTQM77/mitX +12V only PSU **TBD**

DOS Idle, Mean, No external load		
Supply	Current draw [A]	Power consumption [W]
+12V P4	2,499	29,988
<b>Total</b>		<b>30,0</b>

Windows 7, mean 3DMARK2005 ( first scene ) & BiT 6		
Supply	Current draw [A]	Power consumption [W]
+12V P4	6,712	80,544
<b>Total</b>		<b>80,5</b>

S0 Mode, Mean, No external load		
Supply	Current draw [A]	Power consumption [W]
+12V P4	1,615	19,38
<b>Total</b>		<b>19,4</b>

S3 Mode, Mean, No external load		
Supply	Current draw [A]	Power consumption [W]
+12V P4	0,104	1,248
<b>Total</b>		<b>1,24</b>

S5 Mode, Mean, No external load		
Supply	Current draw [A]	Power consumption [W]
+12V P4	0,101	1,212
<b>Total</b>		<b>1,21</b>

### 3 Connector Locations

#### 3.1 Frontside

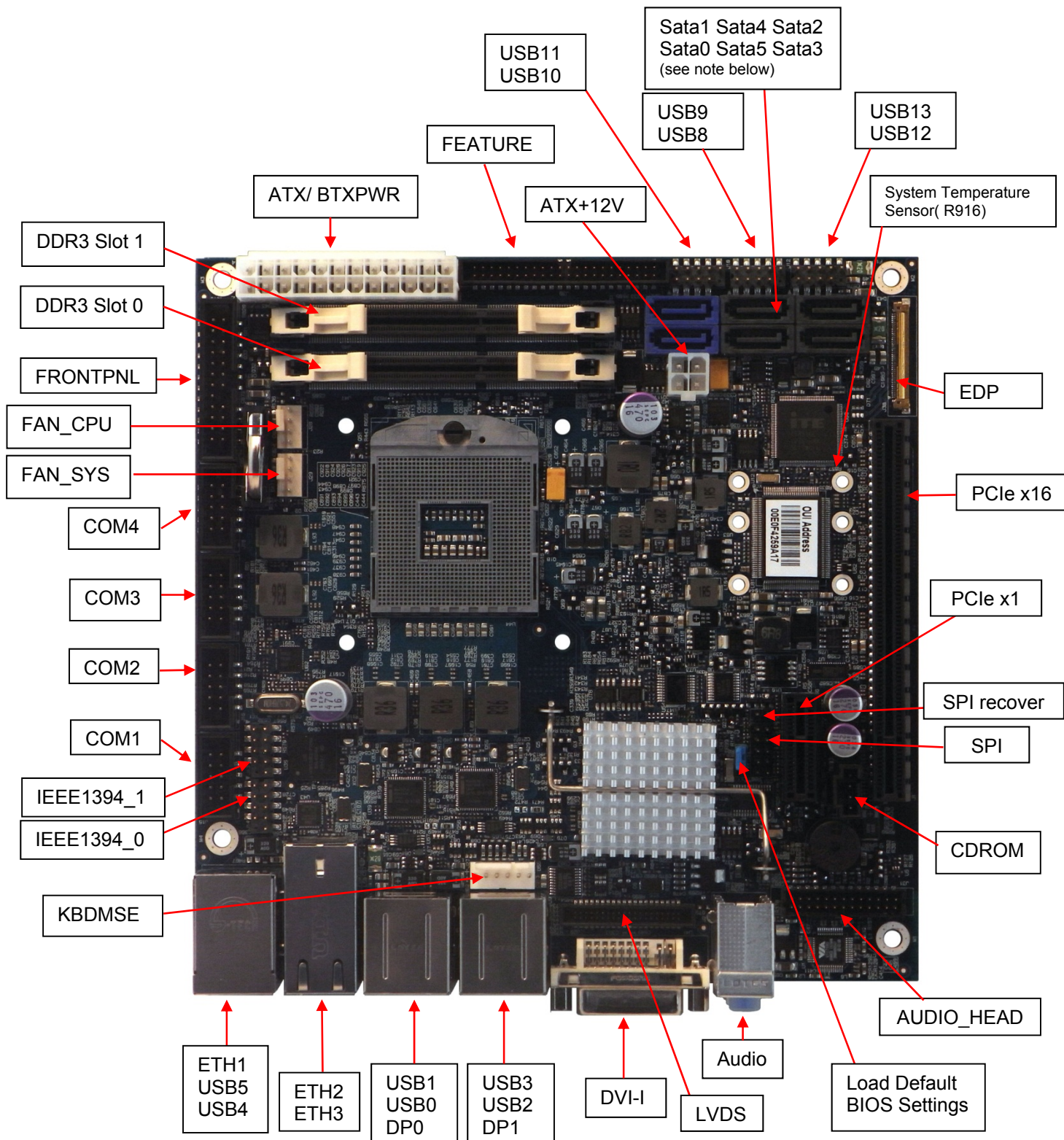

Notes: SATA0/Sata1 support up to 6GB/s and SATA2/Sata3/Sata4/Sata5 support up to 3GB/S. SATA2 is shared with mPCIe0. USB0 – USB3 supports USB3.0/USB2.0. Not available connectors on KTHM76/mITX: IEEE 1394\_0, IEEE 1394\_1, ETH2, ETH3 and EDP.

### 3.2 IO Bracket area

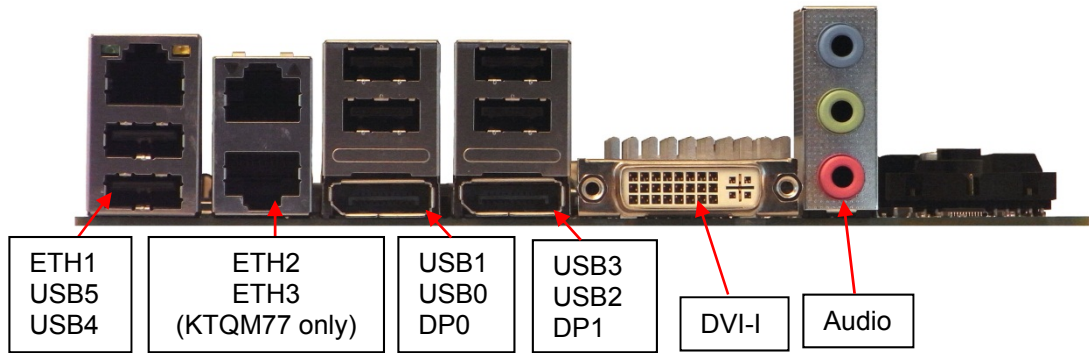

### 3.3 Backside

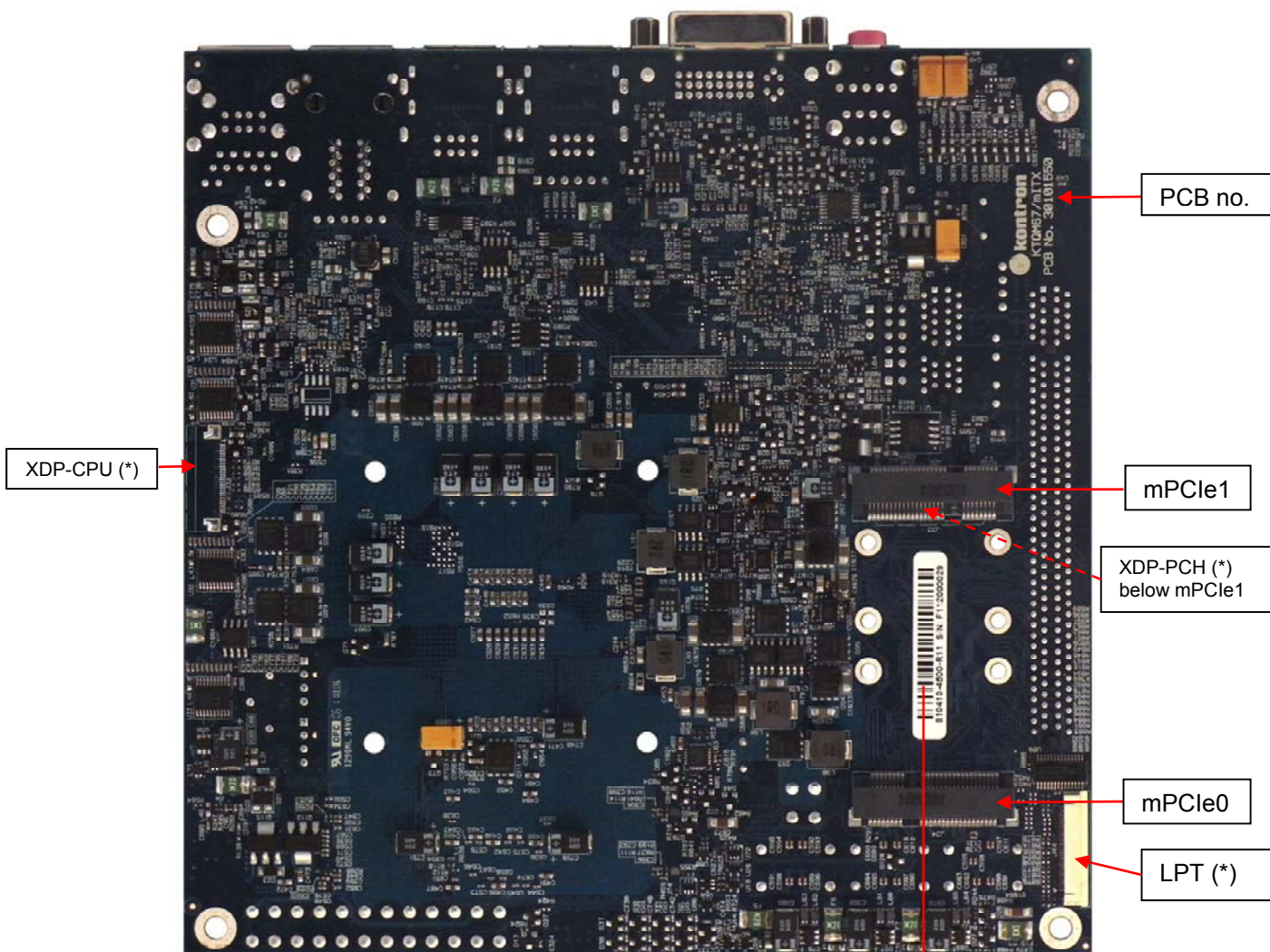

(\*) The XDP and LPT connectors are not supported and not mounted in volume production.

Kontron sub-supplier number. Please use the SN label on the PCIe x16 slot which is the board SN matching the SN in BIOS.

## 4 Connector Definitions

The following sections provide pin definitions and detailed description of all on-board connectors.

The connector definitions follow the following notation:

Column name	Description
Pin	Shows the pin-numbers in the connector. The graphical layout of the connector definition tables is made similar to the physical connectors.
Signal	The mnemonic name of the signal at the current pin. The notation "XX#" states that the signal "XX" is active low.
Type	AI: Analogue Input. AO: Analogue Output. I: Input, TTL compatible if nothing else stated. IO: Input / Output. TTL compatible if nothing else stated. IOT: Bi-directional tristate IO pin. IS: Schmitt-trigger input, TTL compatible. IOC: Input / open-collector Output, TTL compatible. IOD: Input / Output, CMOS level Schmitt-triggered. (Open drain output) NC: Pin not connected. O: Output, TTL compatible. OC: Output, open-collector or open-drain, TTL compatible. OT: Output with tri-state capability, TTL compatible. LVDS: Low Voltage Differential Signal. PWR: Power supply or ground reference pins.
	Ioh: Typical current in mA flowing out of an output pin through a grounded load, while the output voltage is > 2.4 V DC (if nothing else stated). Iol: Typical current in mA flowing into an output pin from a VCC connected load, while the output voltage is < 0.4 V DC (if nothing else stated).
Pull U/D	On-board pull-up or pull-down resistors on input pins or open-collector output pins.
Note	Special remarks concerning the signal.

The abbreviation *TBD* is used for specifications which are not available yet or which are not sufficiently specified by the component vendors.

## 5 IO-Area Connectors

### 5.1 Display connectors (IO Area)

The KTQM77 provides one on-board DVI-I port (both digital and analogue), two on-board DP's (DisplayPort), one on-board eDP (Embedded DisplayPort) and one on-board LVDS panel interface. Two graphic pipes are supported; meaning that up to two independent displays can be implemented using any two of the above mentioned graphic ports.

#### 5.1.1 DVI Connector (DVI-I) (J41)

The **DVI-I** connector support DVI Digital output and DVI Analogue output.

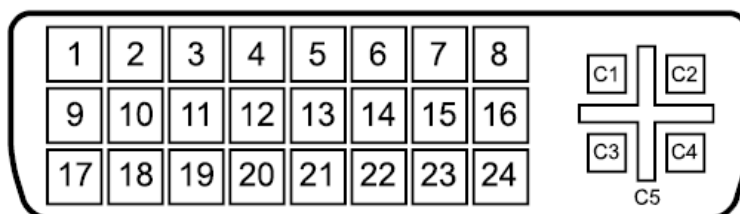

Female socket, front view

Signal Description - DVI Connector:

Pin	Signal	Description	Type	Pull U/D
1	TMDS Data 2-	Digital Red – (Link 1)	LVDS OUT	
2	TMDS Data 2+	Digital Red + (Link 1)	LVDS OUT	
3	TMDS Data 2/4 Shield		PWR	
4	NC		NC	
5	NC		NC	
6	DDC Clock	DDC Clock	IO	2K2
7	DDC Data	DDC Data	IO	2K2
8	ANALOG VSYNC	CRT vertical synchronization output.	O	
9	TMDS Data 1-	Digital Green – (Link 1)	LVDS OUT	
10	TMDS Data 1+	Digital Green + (Link 1)	LVDS OUT	
11	TMDS Data 1/3 Shield		PWR	
12	NC		NC	
13	NC		NC	
14	+5V	Power for monitor when in standby	PWR	
15	GND		PWR	
16	Hot Plug Detect	Hot Plug Detect	I	
17	TMDS Data 0-	Digital Blue – (Link 1) / Digital sync	LVDS OUT	
18	TMDS Data 0+	Digital Blue + (Link 1) / Digital sync	LVDS OUT	
19	TMDS Data 0/5 Shield		PWR	
20	NC		NC	
21	NC		NC	
22	TMDS Clock Shield		PWR	
23	TMDS Clock+	Digital clock + (Link 1)	LVDS OUT	
24	TMDS Clock-	Digital clock - (Link 1)	LVDS OUT	
C1	ANALOG RED	Analog output carrying the red color signal	O	/75R
C2	ANALOG GREEN	Analog output carrying the green color signal	O	/75R
C3	ANALOG BLUE	Analog output carrying the blue color signal	O	/75R
C4	ANALOG HSYNC	CRT horizontal synchronization output.	O	
C5	ANALOG GND	Ground reference for RED, GREEN, and BLUE	PWR	
C6	ANALOG GND	Ground reference for RED, GREEN, and BLUE	PWR	

**Note:** The +5V supply is fused by a 1.1A resettable fuse

### 5.1.2 DP Connectors (DP0/DP1) (J40/J39)

The DP (DisplayPort) connectors are based on standard DP type Foxconn 3VD51203-H7JJ-7H or similar.

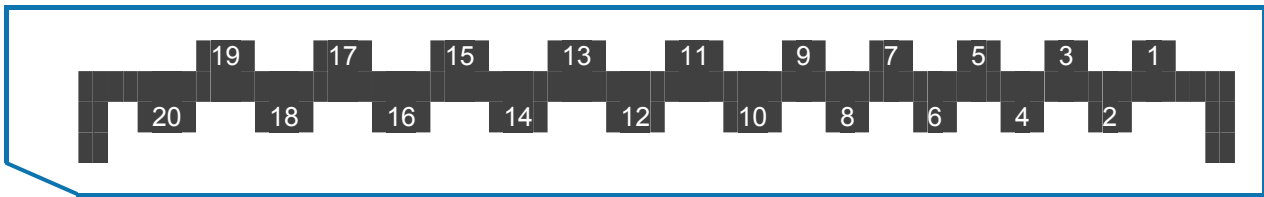

Pin	Signal	Description	Type	Note
1	Lane 0 (p)		LVDS	
2	GND		PWR	
3	Lane 0 (n)		LVDS	
4	Lane 1 (p)		LVDS	
5	GND		PWR	
6	Lane 1 (n)		LVDS	
7	Lane 2 (p)		LVDS	
8	GND		PWR	
9	Lane 2 (n)		LVDS	
10	Lane 3 (p)		LVDS	
11	GND		PWR	
12	Lane 3 (n)		LVDS	
13	Config1	Aux or DDC selection	I	Internally pull down (1Mohm). Aux channel on pin 15/17 selected as default (when NC) DDC channel on pin 15/17, If HDMI adapter used (3.3V)
14	Config2	(Not used)	O	Internally connected to GND
15	Aux Ch (p)	Aux Channel (+) or DDC Clk		AUX (+) channel used by DP DDC Clk used by HDMI
16	GND		PWR	
17	Aux Ch (n)	Aux Channel (-) or DDC Data		AUX (-) channel used by DP DDC Data used by HDMI
18	Hot Plug		I	Internally pull down (100Kohm).
19	Return		PWR	Same as GND
20	3.3V		PWR	Fused by 1.5A resettable PTC fuse, common for DP0 and DP1



## 5.2 Ethernet Connectors

The KTQM77/mITX supports three channels of 10/100/1000Mb Ethernet, one (ETH1) is based on Intel® Lewisville 82579LM Gigabit PHY with AMT 8.0 support and the two other controllers (ETHER2 & ETHER3) are based on Intel® Hartwell 82574L PCI Express controller.

The KTHM76/mITX support one channels of 10/100/1000Mb Ethernet, (ETH1) based on Intel® Lewisville 82579LM Gigabit PHY (AMT not supported).

In order to achieve the specified performance of the Ethernet port, Category 5 twisted pair cables must be used with 10/100MB and Category 5E, 6 or 6E with 1Gb LAN networks.

The signals for the Ethernet ports are as follows:

Signal	Description
MDI[0]+ / MDI[0]-	In MDI mode, this is the first pair in 1000Base-T, i.e. the BI_DA+/- pair, and is the transmit pair in 10Base-T and 100Base-TX. In MDI crossover mode, this pair acts as the BI_DB+/- pair, and is the receive pair in 10Base-T and 100Base-TX.
MDI[1]+ / MDI[1]-	In MDI mode, this is the second pair in 1000Base-T, i.e. the BI_DB+/- pair, and is the receive pair in 10Base-T and 100Base-TX. In MDI crossover mode, this pair acts as the BI_DA+/- pair, and is the transmit pair in 10Base-T and 100Base-TX.
MDI[2]+ / MDI[2]-	In MDI mode, this is the third pair in 1000Base-T, i.e. the BI_DC+/- pair. In MDI crossover mode, this pair acts as the BI_DD+/- pair.
MDI[3]+ / MDI[3]-	In MDI mode, this is the fourth pair in 1000Base-T, i.e. the BI_DD+/- pair. In MDI crossover mode, this pair acts as the BI_DC+/- pair.

**Note:** MDI = Media Dependent Interface.

Ethernet connector 1 (ETH1) is mounted together with USB Ports 4 and 5.

Ethernet connector 2 (ETH2) is mounted together with and above Ethernet connector 3 (ETH3) (KTQM77/mITX only).

The pinout of the RJ45 connectors is as follows:

Signal	PIN	Type	Ioh/Iol	Note
MDI0+	1			
MDI0-	2			
MDI1+	3			
MDI2+	4			
MDI2-	5			
MDI1-	6			
MDI3+	7			
MDI3-	8			

## 5.3 USB Connectors (IO Area)

The KTQM77 board contains two EHCI (Enhanced Host Controller Interface) and one XHCI (Extensible Host Controller Interface). The two EHCI controllers, EHCI1 and EHCI2, supports up to fourteen USB 2.0 ports allowing data transfers up to 480Mb/s. The XHCI controller supports four USB 3.0 ports allowing data transfers up to 5Gb/s. The four USB 3.0 ports are shared with four of the USB 2.0 ports (USB0 – USB3) from the EHCI1.

Legacy Keyboard/Mouse and wakeup from sleep states are supported. Over-current detection on all fourteen USB ports is supported. The following USB connectors are available in the IO Area.

USB Port 0 and 1 (via EHCI1/XHCI) are supplied on the combined USB0, USB1 and DP0 connector.  
 USB Port 2 and 3 (via EHCI1/XHCI) are supplied on the combined USB2, USB3 and DP1 connector.  
 USB Port 4 and 5 (via EHCI1) are supplied on the combined ETH1, USB4 and USB5 connector.

### Note:

For USB2.0 cabling it is required to use only HiSpeed USB cable, specified in USB2.0 standard:

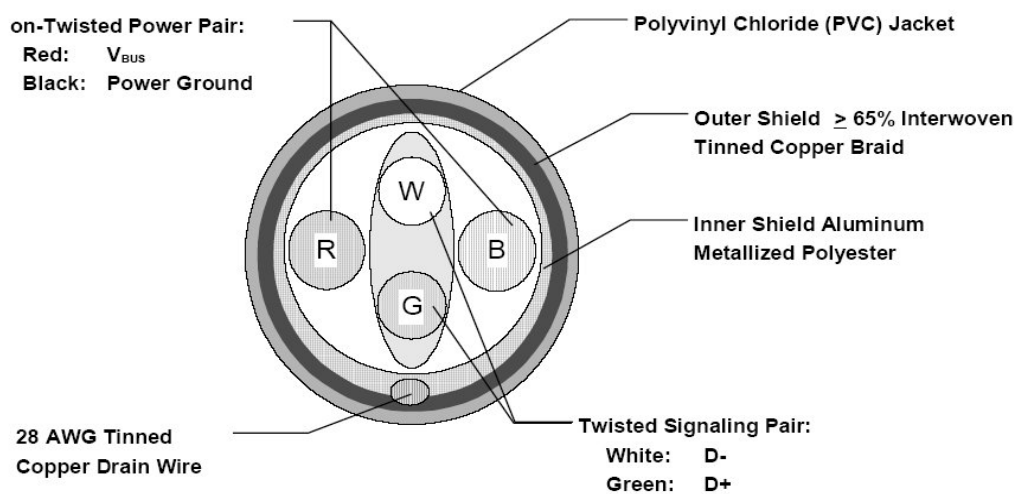

For USB3.0 cabling it is required to use only HiSpeed USB cable, specified in USB3.0 standard:

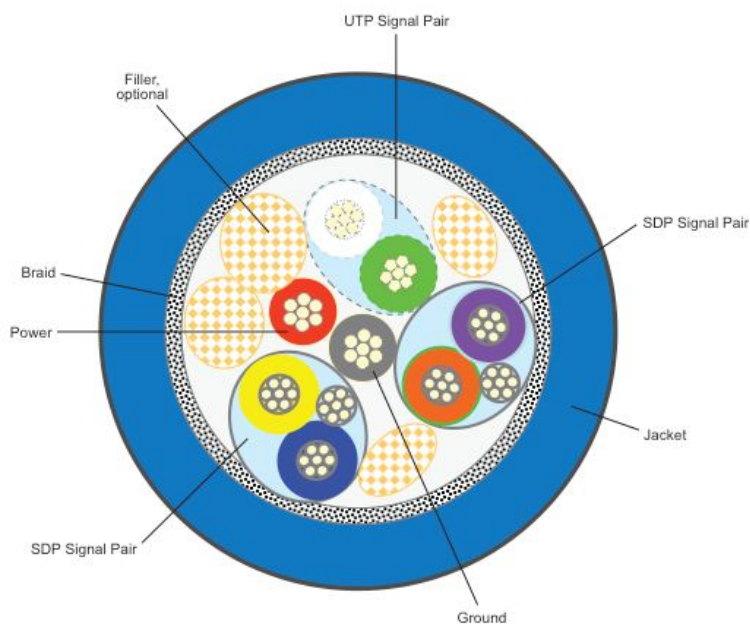

### 5.3.1 USB Connector 0/1 (USB0/1)

USB Ports 0 and 1 are mounted together with DP0 port and supports USB3.0/USB2.0.

Note	Type	Signal	PIN				Signal	Type	Note
	IO		USB1-		USB1+			IO	
1	PWR	5V/SB5V	1	2	3	4	GND	PWR	
	IO	RX1-	5	6	7	8	9	TX1+	IO
	IO		RX1+			TX1-		IO	
	PWR		GND						
	IO		USB0-		USB0+			IO	
1	PWR	5V/SB5V	1	2	3	4	GND	PWR	
	IO	RX0-	5	6	7	8	9	TX0+	IO
	IO		RX0+			TX0-		IO	
	PWR		GND						

**Note 1:** In order to meet the requirements of USB standard, the 5V input supply must be at least 5.00V.

Signal	Description
USB0+ USB0- RX0+ RX0- TX0+ TX0- USB1+ USB1- RX1+ RX1- TX1+ TX1-	Differential pair works as Data/Address/Command Bus.
5V/SB5V	5V supply for external devices. SB5V is supplied during powerdown to allow wakeup on USB device activity. Each port protected by 1.1A – 1.9A overload protection circuit.

### 5.3.2 USB Connector 2/3 (USB2/3)

USB Ports 2 and 3 are mounted together with DP1 port and supports USB3.0/USB2.0.

Note	Type	Signal	PIN	Signal	Type	Note	
	IO	USB3-	1 2 3 4	USB3+	IO		
1	PWR	5V/SB5V	1 2 3 4	GND	PWR		
	IO	RX3-	5 6 7 8 9	TX3+	IO		
	IO	RX3+		TX3-	IO		
	PWR	GND					
	IO	USB2-	1 2 3 4	USB2+	IO		
1	PWR	5V/SB5V	1 2 3 4	GND	PWR		
	IO	RX2-	5 6 7 8 9	TX2+	IO		
	IO	RX2+		TX2-	IO		
	PWR	GND					

**Note 1:** In order to meet the requirements of USB standard, the 5V input supply must be at least 5.00V.

Signal	Description
USB2+ USB2- RX2+ RX2- TX2+ TX2- USB3+ USB3- RX3+ RX3- TX3+ TX3-	Differential pair works as Data/Address/Command Bus.
5V/SB5V	5V supply for external devices. SB5V is supplied during powerdown to allow wakeup on USB device activity. Each port protected by 1.1A – 1.9A overload protection circuit.

### 5.3.3 USB Connector 4/5 (USB4/5)

USB Ports 4 and 5 are mounted together with ETH1 port and supports USB2.0.

Note	Type	Signal	PIN	Signal	Type	Note
1	PWR	5V/SB5V	1 2 3 4	GND	PWR	
	IO	USB5-		USB5+	IO	
1	PWR	5V/SB5V	1 2 3 4	GND	PWR	
	IO	USB4-		USB4+	IO	

**Note 1:** In order to meet the requirements of USB standard, the 5V input supply must be at least 5.00V.

Signal	Description
USB4+ USB4- USB5+ USB5-	Differential pair works as Data/Address/Command Bus.
5V/SB5V	5V supply for external devices. SB5V is supplied during powerdown to allow wakeup on USB device activity. Each port protected by resettable 1A fuse.

## 5.4 Audio Connector (IO Area)

The on-board Audio circuit implements 7.1+2 Channel High Definition Audio with UAA (Universal Audio Architecture), featuring five 24-bit stereo DACs and three 20-bit stereo ADCs. The Following Audio connector is available in IO Area.

Audio Speakers, Line-in and Microphone are available in the stacked audiojack connector.

	Signal	Type	Note
TIP RING SLEEVE	LINE1-L	IA	
	LINE1-R	IA	
	GND	PWR	
TIP RING SLEEVE	FRONT-OUT-L	OA	
	FRONT-OUT-R	OA	
	GND	PWR	
TIP RING SLEEVE	MIC1-L	IA	
	MIC1-R	IA	
	GND	PWR	

Signal	Description	Note
FRONT-OUT-L	Front Speakers (Speaker Out Left).	
FRONT-OUT-R	Front Speakers (Speaker Out Right).	
MIC1-L	Microphone 1 - Left	Shared with Audio Header
MIC1-R	Microphone 1 - Right	Shared with Audio Header
LINE1-L	Line 1 signal - Left	Shared with Audio Header
LINE1-R	Line 1 signal - Right	Shared with Audio Header

## 6 Internal Connectors

### 6.1 Power Connector (ATX/BTXPWR)

The KTQM77 boards are designed to be supplied from a standard ATX (or BTX) power supply. Alternatively supplied by single +12V +/-5%. Use of BTX supply is not required for operation, but may be required to drive high-power PCIe cards.

ATX/ BTX Power Connector (J43):

Note	Type	Signal	PIN		Signal	Type	Note
	PWR	3V3	12	24	GND	PWR	
	PWR	+12V	11	23	5V	PWR	
	PWR	+12V	10	22	5V	PWR	
	PWR	SB5V	9	21	5V	PWR	
	I	P_OK	8	20	-5V	PWR	1
	PWR	GND	7	19	GND	PWR	
	PWR	5V	6	18	GND	PWR	
	PWR	GND	5	17	GND	PWR	
	PWR	5V	4	16	PS_ON#	OC	
	PWR	GND	3	15	GND	PWR	
	PWR	3V3	2	14	-12V	PWR	
	PWR	3V3	1	13	3V3	PWR	

**Note 1:** -5V supply is not used on-board.

See chapter “Power Consumption” regarding input tolerances on 3.3V, 5V, SB5V, +12 and -12V (also refer to ATX specification version 2.2).

ATX+12V-4pin Power Connector (J42):

Note	Type	Signal	PIN		Signal	Type	Note
	PWR	GND	2	4	+12V	PWR	1
	PWR	GND	1	3	+12V	PWR	1

**Note 1:** Use of the 4-pin ATX+12V Power Connector is required for operation of KTQM77.

Signal	Description
P_OK	<p>P_OK is a power good signal and should be asserted high by the power supply to indicate that the +5VDC and +3.3VDC outputs are above the undervoltage thresholds of the power supply. When this signal is asserted high, there should be sufficient energy stored by the converter to guarantee continuous power operation within specification. Conversely, when the output voltages fall below the undervoltage threshold, or when mains power has been removed for a time sufficiently long so that power supply operation is no longer guaranteed, P_OK should be de-asserted to a low state. The recommended electrical and timing characteristics of the P_OK (PWR_OK) signal are provided in the <i>ATX12V Power Supply Design Guide</i>.</p> <p>It is strongly recommended to use an ATX or BTX supply, in order to implement the supervision of the 5V and 3V3 supplies. These supplies are not supervised on-board.</p>
PS_ON#	Active low open drain signal from the board to the power supply to turn on the power supply outputs. Signal must be pulled high by the power supply.

**Warning:** Hot Plugging power supply is not supported. Hot plugging might damage the board.

## 6.2 Fan Connectors (FAN\_CPU) (J28) and (FAN\_SYS) (J29)

The **FAN\_CPU** is used for the connection of the FAN for the CPU.

The **FAN\_SYS** can be used to power, control and monitor a fan for chassis ventilation etc.

The 4pin header is recommended to be used for driving 4-wire type Fan in order to implement FAN speed control. 3-wire Fan is also possible, but no fan speed control is integrated.

### 4-pin Mode:

PIN	Signal	Type	Ioh/Iol	Pull U/D	Note
1	CONTROL	O	-	-	
2	SENSE	I	-	4K7	
3	+12V	PWR	-	-	
4	GND	PWR	-	-	

Signal	Description
CONTROL	PWM signal for FAN speed control
SENSE	Tacho signal from the fan for supervision. The signals shall be generated by an open collector transistor or similar. On-board is a pull-up resistor 4K7 to +12V. The signal has to be pulsed, typically twice per rotation.
12V	+12V supply for fan. A maximum of 2000mA can be supplied from this pin.
GND	Power Supply GND signal

### 3-pin Mode:

PIN	Signal	Type	Ioh/Iol	Pull U/D	Note
-					
2	SENSE	I	-	4K7	
3	+12V	PWR	-	-	
4	GND	PWR	-	-	

Signal	Description
SENSE	Tacho signal from the fan for supervision. The signals shall be generated by an open collector transistor or similar. On-board is a pull-up resistor 4K7 to +12V. The signal has to be pulsed, typically twice per rotation.
12V	+12V supply for fan. A maximum of 2000mA can be supplied from this pin.
GND	Power Supply GND signal

### 6.3 PS/2 Keyboard and Mouse connector (KBDMSE) (J27)

Attachment of a PS/2 keyboard/mouse can be done through the pinrow connector KBDMSE (J27). Both interfaces utilize open-drain signalling with on-board pull-up.

The PS/2 mouse and keyboard is supplied from SB5V when in standby mode in order to enable keyboard or mouse activity to bring the system out from power saving states. The supply is provided through a 1.1A resettable fuse.

PIN	Signal	Type	Ioh/Iol	Pull U/D	Note
1	KBDCLK	IOD	/14mA	2K7	
2	KBDDAT	IOD	/14mA	2K7	
3	MSCLK	IOD	/14mA	2K7	
4	MSDAT	IOD	/14mA	2K7	
5	5V/SB5V	PWR	-	-	
6	GND	PWR	-	-	

Signal Description – Keyboard & and mouse Connector (KBDMSE).

Signal	Description
MSCLK	Bi-directional clock signal used to strobe data/commands from/to the PS/2 mouse.
MSDAT	Bi-directional serial data line used to transfer data from or commands to the PS/2 mouse.
KDBCLK	Bi-directional clock signal used to strobe data/commands from/to the PC-AT keyboard.
KBDDAT	Bi-directional serial data line used to transfer data from or commands to the PC-AT keyboard.

Available cable kit:

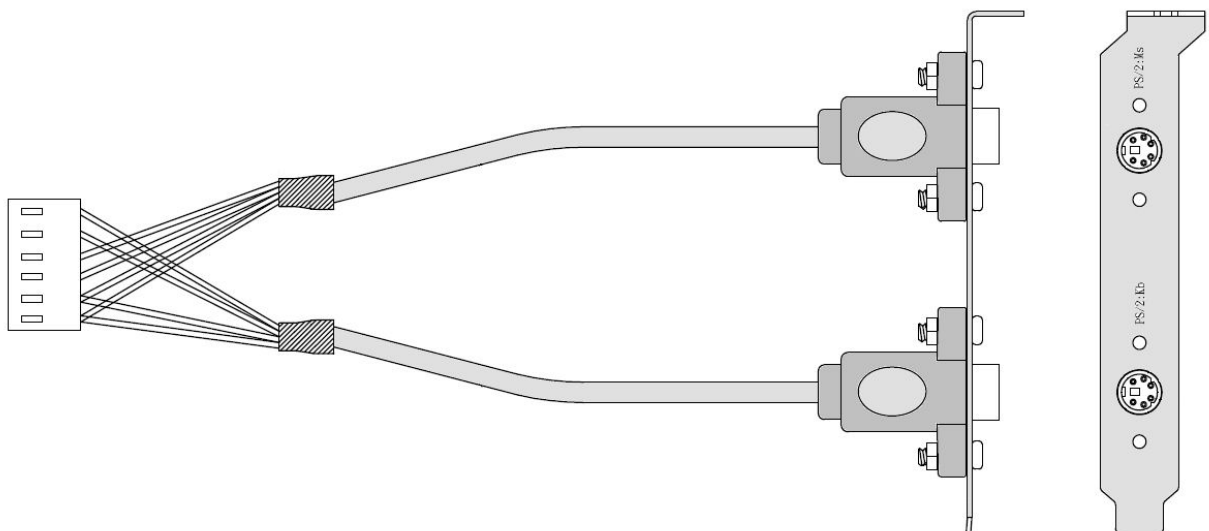

PN 1053-2384 Bracket Cable 6-Pin to PS2-Kbd-Mse



## 6.4 Display connectors (Internal)

The KTQM77 provides internal display connectors: one on-board LVDS panel interface and one on-board eDP (Embedded DisplayPort) (KTQM77/mITX only). LVDS and eDP cannot be used at the same time.

For IO Area Display Connectors (DVI-I and two DP's), see earlier section.

### 6.4.1 eDP connector (EDP) (J38)

The eDP connector (KTQM77/mITX only) is based on single in-line 40 pole connector type TYCO 5-2069716-3.

Pin	Signal	Description	Type	Note
1	NC		NC	
2	BL-VCC	Backlight Voltage	PWR	Fused by 1.5A resettable PTC fuse 12V (in S0 mode)
3	BL-VCC		PWR	
4	BL-VCC		PWR	
5	BL-VCC		PWR	
6	NC		NC	
7	NC		NC	
8	BL-PWM	Back Light PWM (Pulse Width Modulated)	O	To adjust Back Light intensity
9	BL-EN	Back Light Enable	O	To enable the Back Light
10	BL-GND	Backlight GND	PWR	
11	BL-GND		PWR	
12	BL-GND		PWR	
13	BL-GND		PWR	
14	HPD	Hot Plug Detection	I	
15	LCD-GND	Display panel GND	PWR	
16	LCD-GND		PWR	
17	LCD-GND		PWR	
18	LCD-GND		PWR	
19	NC		NC	
20	LCD-VCC	Display panel voltage	PWR	Shared with LVDS connector 3.3V or 5V selected in BIOS Fused by 1.5A resettable PTC fuse
21	LCD-VCC		PWR	
22	LCD-VCC		PWR	
23	LCD-VCC		PWR	
24	GND		PWR	
25	Aux (n)		LVDS	
26	Aux (p)		LVDS	
27	GND		PWR	
28	Lane 0 (p)		LVDS	
29	Lane 0 (n)		LVDS	
30	GND		PWR	
31	Lane 1 (p)		LVDS	
32	Lane 1 (n)		LVDS	
33	GND		PWR	
34	Lane 2 (p)		LVDS	
35	Lane 2 (n)		LVDS	
36	GND		PWR	
37	Lane 3 (p)		LVDS	
38	Lane 3 (n)		LVDS	
39	GND		PWR	
40	NC		NC	

### 6.4.2 LVDS Flat Panel Connector (LVDS) (J20)

The LVDS connector is based on 40 pole connector type Don Connex C44-40BSB1-G.

Note	Type	Signal	PIN	Signal	Type	Note
Max. 0.5A	PWR	+12V	1 2	+12V	PWR	Max. 0.5A
Max. 0.5A	PWR	+12V	3 4	+12V	PWR	Max. 0.5A
Max. 0.5A	PWR	+12V	5 6	GND	PWR	Max. 0.5A
Max. 0.5A	PWR	+5V	7 8	GND	PWR	Max. 0.5A
Max. 0.5A	PWR	LCDVCC	9 10	LCDVCC	PWR	Max. 0.5A
2K2Ω, 3.3V	OT	DDC CLK	11 12	DDC DATA	OT	2K2Ω, 3.3V
3.3V level	OT	BKLTCTL	13 14	VDD ENABLE	OT	3.3V level
3.3V level	OT	BKLTEN#	15 16	GND	PWR	Max. 0.5A
	LVDS	LVDS A0-	17 18	LVDS A0+	LVDS	
	LVDS	LVDS A1-	19 20	LVDS A1+	LVDS	
	LVDS	LVDS A2-	21 22	LVDS A2+	LVDS	
	LVDS	LVDS ACLK-	23 24	LVDS ACLK+	LVDS	
	LVDS	LVDS A3-	25 26	LVDS A3+	LVDS	
Max. 0.5A	PWR	GND	27 28	GND	PWR	Max. 0.5A
	LVDS	LVDS B0-	29 30	LVDS B0+	LVDS	
	LVDS	LVDS B1-	31 32	LVDS B1+	LVDS	
	LVDS	LVDS B2-	33 34	LVDS B2+	LVDS	
	LVDS	LVDS BCLK-	35 36	LVDS BCLK+	LVDS	
	LVDS	LVDS B3-	37 38	LVDS B3+	LVDS	
Max. 0.5A	PWR	GND	39 40	GND	PWR	Max. 0.5A

**Note:** The KTQM77 on-board LVDS connector supports single and dual channel, 18/24bit SPWG panels up to the resolution 1600x1200 or 1920x1080 and with limited frame rate some 1920x1200.

Signal Description – LVDS Flat Panel Connector:

Signal	Description
LVDS A0..A3	LVDS A Channel data
LVDS ACLK	LVDS A Channel clock
LVDS B0..B3	LVDS B Channel data
LVDS BCLK	LVDS B Channel clock
BKLTCTL	Backlight control (1), PWM signal to implement voltage in the range 0-3.3V
BKLTEN#	Backlight Enable signal (active low) (2)
VDD ENABLE	Output Display Enable.
LCDVCC	VCC supply to the display. Power-on/off sequencing depending on selected (in BIOS setup) display type. 5V or 3.3V selected in BIOS setup. LCDVCC is shared with eDP connector. Maximum load is 1A at both voltages.
DDC CLK	DDC Channel Clock

**Notes:** Windows API will be available to operate the BKLTCTL signal. Some Inverters have a limited voltage range 0- 2.5V for this signal: If voltage is > 2.5V the Inverter might latch up. Some Inverters generates noise on the BKLTCTL signal, resulting in making the LVDS transmission failing (corrupted picture on the display). By adding a 1Kohm resistor in series with this signal, mounted in the Inverter end of the cable kit, the noise is limited and the picture is stable.

If the Backlight Enable is required to be active high then, check the following BIOS Chipset setting: Backlight Signal Inversion = Enabled.

## 6.5 SATA (Serial ATA) Disk interface (J21 – J26)

The KTQM77 has an integrated SATA Host controller (PCH in the QM77 chipset) that supports independent DMA operation on six ports. One device can be installed on each port for a maximum of six SATA devices. A point-to-point interface (SATA cable) is used for host to device connections. Data transfer rates of up to 6.0Gb/s (typically 600MB/s) on SATA0 and SATA1 and 3.0Gb/s (typically 300MB/s) on SATA2, SATA3, SATA4 and SATA5. SATA2 is shared with mPCIe0.

**Note:** Before installing OS on a SATA drive make sure the drive is not a former member of a RAID system. If so some hidden data on the disk has to be erased. To do this, connect two SATA drives and select RAID in BIOS. Save settings and select <Ctrl> <I> while booting to enter the RAID setup menu. Now the hidden RAID data will be erased from the selected SATA drive.

The SATA controller supports:

RAID (Redundant Array of Independent Drives) based on a firmware system (KTQM77/mITX only):

- 2 to 6-drive RAID 0 (data striping)
- 2-drive RAID 1 (data mirroring)
- 3 to 6-drive RAID 5 (block-level striping with parity)
- 4-drive RAID 10 (data striping and mirroring)
- 2 to 6-drive matrix RAID, parts of a single drive can be assigned to different RAIDs

AHCI (Advanced Host Controller Interface)

NCQ (Native Command Queuing). NCQ is for faster data access.

Hot Swap

Intel® Rapid Recover Technology

2 – 256TB volume (Data volumes only)

Capacity expansion

TRIM in Windows 7 (in AHCI and RAID mode for drives not part of a RAID volume). (TRIM is for SSD data garbage handling).

SATA connector pinning:

SATA0 (J21), SATA1 (J22), SATA2 (J23), SATA3 (J24), SATA4 (J25) and SATA5 (J26).

PIN	Signal	Type	Ioh/Iol	Pull U/D	Note
1	GND	PWR	-	-	
2	SATA* TX+				
3	SATA* TX-				
4	GND	PWR	-	-	
5	SATA* RX-				
6	SATA* RX+				
7	GND	PWR	-	-	

Signal	Description
SATA* RX+ SATA* RX-	Host transmitter differential signal pair
SATA* TX+ SATA* TX-	Host receiver differential signal pair

“\*” specifies 0, 1, 2, 3, 4, 5 depending on SATA port.

Available cable kit:



## 6.6 USB Connectors (USB)

The KTQM77 board contains two EHCI (Enhanced Host Controller Interface) host controllers (EHCI1 and EHCI2) that support up to fourteen USB 2.0 ports allowing data transfers up to 480Mb/s. Legacy Keyboard/Mouse and wakeup from sleep states are supported. Over-current detection on all fourteen USB ports is supported.

Note that four USB 3.0 ports are shared with four of the USB 2.0 ports (USB0 – USB3) from the EHCI1.

The following USB ports are available on Internal Pinrows:

USB Port 6 and 7 (KTQM77/mITX only) (via EHCI1) are supplied on the USB6/7 internal pinrow FRONTPNL connector.

USB Port 8 and 9 (via EHCI2) are supplied on the USB8/9 internal pinrow connector.

USB Port 10 and 11 (via EHCI2) are supplied on the USB10/11 internal pinrow connector.

USB Port 12 and 13 (via EHCI2) are supplied on the USB12/13 internal pinrow connector.

**Note:** It is required to use only HiSpeed USB cable, specified in USB2.0 standard:

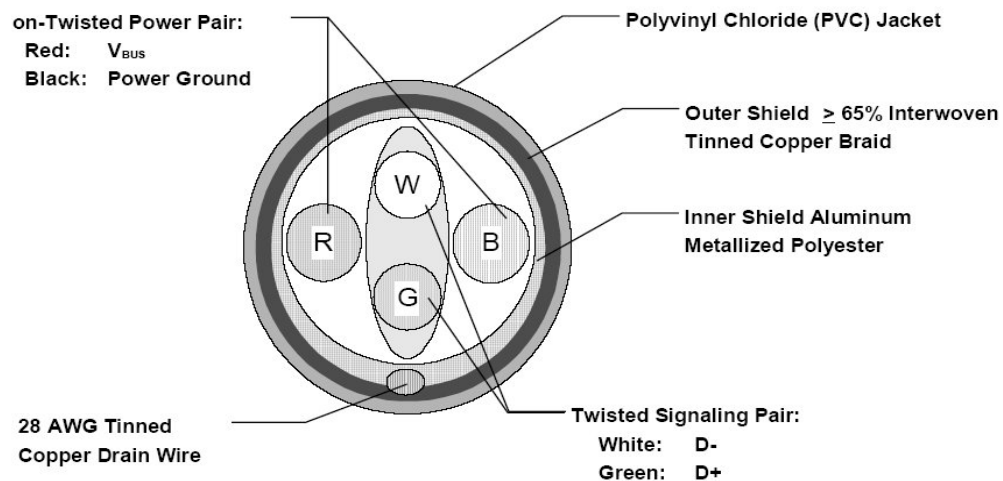

### 6.6.1 USB Connector 6/7

See Frontpanel Connector (FRONTPNL) description (KTQM77/mITX only).

### 6.6.2 USB Connector 8/9 (USB8/9) (J10)

USB Ports 8 and 9 are supplied on the internal USB8/9 pinrow connector J10.

Note	Type	Signal	PIN	Signal	Type	Note
1	PWR	5V/SB5V	1 2	5V/SB5V	PWR	1
	IO	USB8-	3 4	USB9-	IO	
	IO	USB8+	5 6	USB9+	IO	
	PWR	GND	7 8	GND	PWR	
	NC	KEY	9 10	NC	NC	

Signal	Description
USB8+ USB8- USB9+ USB9-	Differential pair works as Data/Address/Command Bus.
5V/SB5V	5V supply for external devices. SB5V is supplied during powerdown to allow wakeup on USB device activity. Each port protected by resettable 1A fuse.

### 6.6.3 USB Connector 10/11 (USB10/11) (J11)

USB Ports 10 and 11 are supplied on the internal USB10/11 pinrow connector J11.

Note	Type	Signal	PIN		Signal	Type	Note
1	PWR	5V/SB5V	1	2	5V/SB5V	PWR	1
	IO	USB10-	3	4	USB11-	IO	
	IO	USB10+	5	6	USB11+	IO	
	PWR	GND	7	8	GND	PWR	
	NC	KEY	9	10	NC	NC	

Signal	Description
USB10+ USB10- USB11+ USB11-	Differential pair works as Data/Address/Command Bus.
5V/SB5V	5V supply for external devices. SB5V is supplied during powerdown to allow wakeup on USB device activity. Each port protected by resettable 1A fuse.

### 6.6.4 USB Connector 12/13 (USB12/13) (J12)

USB Ports 12 and 13 are supplied on the internal USB12/13 pinrow connector J12.

Note	Type	Signal	PIN		Signal	Type	Note
1	PWR	5V/SB5V	1	2	5V/SB5V	PWR	1
	IO	USB12-	3	4	USB13-	IO	
	IO	USB12+	5	6	USB13+	IO	
	PWR	GND	7	8	GND	PWR	
	NC	KEY	9	10	NC	NC	

Signal	Description
USB12+ USB12- USB13+ USB13-	Differential pair works as Data/Address/Command Bus.
5V/SB5V	5V supply for external devices. SB5V is supplied during powerdown to allow wakeup on USB device activity. Each port protected by resettable 1A fuse.

**Note 1:** In order to meet the requirements of USB standard, the 5V input supply must be at least 5.00V.

Available cable kit:

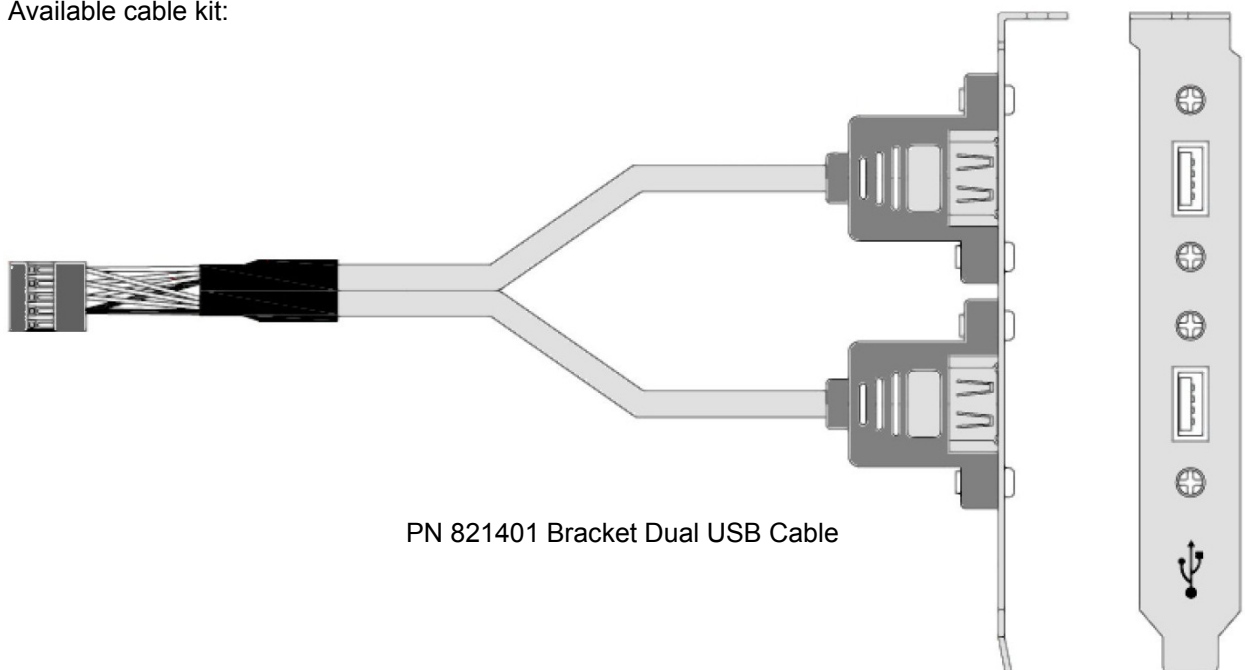

PN 821401 Bracket Dual USB Cable

## 6.7 Firewire/IEEE1394 connectors (J13,J14)

The KTQM77/mITX (only) support two IEEE Std 1394a-2000 fully compliant ports at 100M bits/s, 200M bits/s and 400M bits/s.

### 6.7.1 IEEE1394 connector (IEEE1394\_0) (J14)

Note	Pull U/D	Ioh/Iol	Type	Signal	PIN		Signal	Type	Ioh/Iol	Pull U/D	Note
	-	-		TPA0+	1	2	TPA0-		-	-	
	-	-	PWR	GND	3	4	GND	PWR	-	-	
	-	-		TPB0+	5	6	TPB0-		-	-	
1	-	-	PWR	+12V	7	8	+12V	PWR	-	-	1
key	-	-	NC	-	9	10	GND	PWR	-	-	

**Note 1:** The 12V supply for the IEEE1394\_0 devices is on-board fused with a 1.25A reset-able fuse.

Signal	Description
TPA0+, TPA0-	Differential signal pair A
TPB0+, TPB0-	Differential signal pair B
+12V	+12V supply

### 6.7.2 IEEE1394 connector (IEEE1394\_1) (J13)

Note	Pull U/D	Ioh/Iol	Type	Signal	PIN		Signal	Type	Ioh/Iol	Pull U/D	Note
	-	-		TPA0+	1	2	TPA0-		-	-	
	-	-	PWR	GND	3	4	GND	PWR	-	-	
	-	-		TPB0+	5	6	TPB0-		-	-	
1	-	-	PWR	+12V	7	8	+12V	PWR	-	-	1
key	-	-	NC	-	9	10	GND	PWR	-	-	

**Note 1:** The 12V supply for the IEEE1394\_1 devices is on-board fused with a 1.25A reset-able fuse.

Signal	Description
TPA1+, TPA1-	Differential signal pair A
TPB1+, TPB1-	Differential signal pair B
+12V	+12V supply

## 6.8 Serial COM1 – COM4 Ports (J15, J16, J17, J18)

Four RS232 serial ports are available on the KTQM77.

The typical definition of the signals in the COM ports is as follows:

Signal	Description
TxD	Transmitted Data, sends data to the communications link. The signal is set to the marking state (-12V) on hardware reset when the transmitter is empty or when loop mode operation is initiated.
RxD	Received Data, receives data from the communications link.
DTR	Data Terminal Ready, indicates to the modem etc. that the on-board UART is ready to establish a communication link.
DSR	Data Set Ready, indicates that the modem etc. is ready to establish a communications link.
RTS	Request To Send, indicates to the modem etc. that the on-board UART is ready to exchange data.
CTS	Clear To Send, indicates that the modem or data set is ready to exchange data.
DCD	Data Carrier Detect, indicates that the modem or data set has detected the data carrier.
RI	Ring Indicator, indicates that the modem has received a ringing signal from the telephone line.

The pinout of Serial ports COM1 (J15), COM2 (J16), COM3 (J17) and COM4 (J18) is as follows:

Note	Ioh/Iol	Type	Signal	PIN		Signal	Type	Ioh/Iol	Note
	-	I	DCD	1	2	DSR	I	-	
	-	I	RxD	3	4	RTS	O	-	
		O	TxD	5	6	CTS	I	-	
		O	DTR	7	8	RI	I	-	
	-	PWR	GND	9	10	5V	PWR	-	1

**Note 1:** The COM1, COM2, COM3 and COM4 5V supply is fused with common 1.1A resettable fuse.

DB9 adapter cables (PN 821016 200mm long and 821017 100mm long) are available for implementing standard COM ports on chassis.

Available cable kit (DB9 adapter cables):

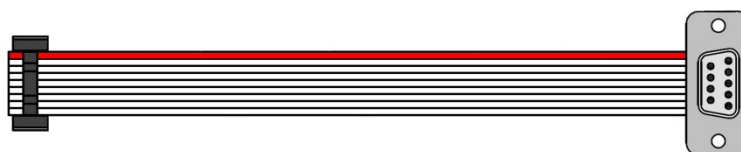

PN 821017 - 100 mm or PN 821016 - 200 mm

## 6.9 Audio Connectors

The on-board Audio circuit implements 7.1+2 Channel High Definition Audio with UAA (Universal Audio Architecture), featuring five 24-bit stereo DACs and three 20-bit stereo ADCs.

The following Audio connectors are available as Internal connectors.

### 6.9.1 CDROM Audio Input (CDROM) (J3)

CD-ROM audio input may be connected to this connector or it can be used as secondary line-in signal.

PIN	Signal	Type	Note
1	CD_Left	IA	1
2	CD_GND	IA	
3	CD_GND	IA	
4	CD_Right	IA	1

**Note 1:** The definition of which pins are used for the Left and Right channels is not a worldwide accepted standard. Some CDROM cable kits expect reverse pin order.

Signal	Description
CD_Left CD_Right	Left and right CD audio input lines or secondary Line-in.
CD_GND	Analogue GND for Left and Right CD. (This analogue GND is <b>not</b> shorted to the general digital GND on the board).

### 6.9.2 Line2 and Mic2

Line2 and Mic2 are accessible via Front Panel Connector, see Front Panel connector description.



### 6.9.3 Audio Header Connector (AUDIO\_HEAD) (J31)

Note	Type	Signal	PIN		Signal	Type	Note
	AO	LFE-OUT	1	2	CEN-OUT	AO	
	PWR	AAGND	3	4	AAGND	PWR	
1	AO	FRONT-OUT-L	5	6	FRONT-OUT-R	AO	1
	PWR	AAGND	7	8	AAGND	PWR	
	AO	REAR-OUT-L	9	10	REAR-OUT-R	AO	
	AO	SIDE-OUT-L	11	12	SIDE-OUT-R	AO	
	PWR	AAGND	13	14	AAGND	PWR	
1	AI	MIC1-L	15	16	MIC1-R	AI	1
	PWR	AAGND	17	18	AAGND	PWR	
1		LINE1-L	19	20	LINE1-R		1
	NC	NC	21	22	AAGND	PWR	
	PWR	GND	23	24	NC	NC	
	O	SPDIF-OUT	25	26	GND	PWR	

**Note 1:** Shared with Audio Stack connector

Signal	Description
FRONT-OUT-L	Front Speakers (Speaker Out Left).
FRONT-OUT-R	Front Speakers (Speaker Out Right).
REAR-OUT-L	Rear Speakers (Surround Out Left).
REAR-OUT-R	Rear Speakers (Surround Out Right).
SIDE-OUT-L	Side speakers (Surround Out Left)
SIDE-OUT-R	Side speakers (Surround Out Right)
CEN-OUT	Center Speaker (Center Out channel).
LFE-OUT	Subwoofer Speaker (Low Freq. Effect Out).
NC	No connection
MIC1	MIC Input 1
LINE1	Line 1 signals
F-SPDIF-OUT	S/PDIF Output
AAGND	Audio Analogue ground

Available cable kit:

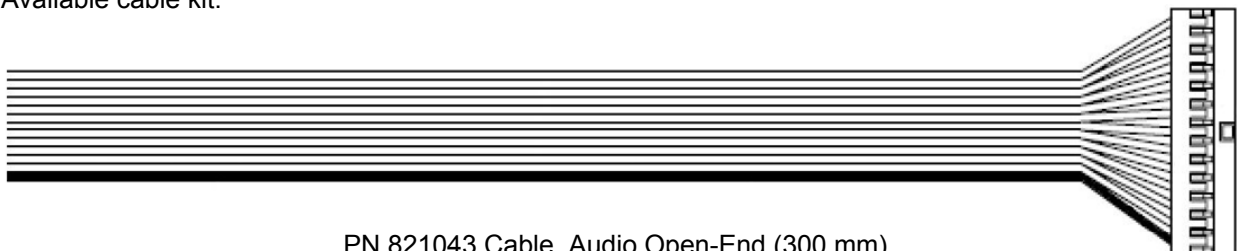

PN 821043 Cable, Audio Open-End (300 mm)

### 6.9.4 Front Panel Connector (FRONTPNL) (J19)

Note	Pull U/D	Ioh/Iol	Type	Signal	PIN	Signal	Type	Ioh/Iol	Pull U/D	Note
	-	-	PWR	USB6/7_5V	1 2	USB6/7_5V	PWR	-	-	
1	-	-		USB6-	3 4	USB7-		-	-	1
1	-	-		USB6+	5 6	USB7+		-	-	1
	-	-	PWR	GND	7 8	GND	PWR	-	-	
	-	-	NC	NC	9 10	LINE2-L		-	-	
	-	-	PWR	+5V	11 12	+5V	PWR	-	-	
	-	25/25mA	O	SATA_LED#	13 14	SUS_LED	O	7mA	-	
	-	-	PWR	GND	15 16	PWRBTN_IN#	I		1K1	
	4K7	-	I	RSTIN#	17 18	GND	PWR	-	-	
	-	-	PWR	SB3V3	19 20	LINE2-R		-	-	
	-	-	PWR	AGND	21 22	AGND	PWR	-	-	
	-	-	AI	MIC2-L	23 24	MIC2-R	AI	-	-	

Note 1: USB 6 / 7 only supported by KTQM77/mITX.

Signal	Description
USB6/7_5V	5V supply for external devices. SB5V is supplied during powerdown to allow wakeup on USB device activity. Each port protected by resettable 1A fuse.
USB6+/USB6-	Universal Serial Bus Port 6 Differentials: Bus Data/Address/Command Bus.
USB7+/USB7-	Universal Serial Bus Port 7 Differentials: Bus Data/Address/Command Bus.
+5V	Maximum load is 1A or 2A per pin if using IDC connector flat cable or crimp terminals respectively.
SATA_LED#	SATA Activity LED (active low signal). 3V3 output when passive.
SUS_LED	Suspend Mode LED (active high signal). Output 3.3V via 470Ω.
PWRBTN_IN#	Power Button In. Toggle this signal low to start the ATX / BTX PSU and boot the board.
RSTIN#	Reset Input. When pulled low for a minimum 16ms, the reset process will be initiated. The reset process continues even though the Reset Input is kept low.
LINE2	Line2 is second stereo Line signals
MIC2	MIC2 is second stereo microphone input.
SB3V3	Standby 3.3V voltage
AGND	Analogue Ground for Audio

**Note:** In order to meet the requirements of USB standard, the 5V input supply must be at least 5.00V.

Available cable kit:

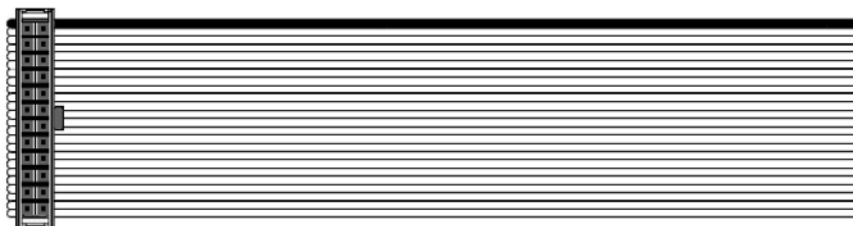

PN 821042 Cable Front Panel Open-End, 300 mm

## 6.10 Feature Connector (FEATURE) (J30)

Note	Pull U/D	Ioh/Iol	Type	Signal	PIN	Signal	Type	Ioh/Iol	Pull U/D	Note
2	2M/	-	I	CASE_OPEN#	1 2	SMBC		/4mA	10K/	1
	-	25/25mA	O	S5#	3 4	SMBD		/4mA	10K/	1
	-	25/25mA	O	PWR_OK	5 6	EXT_BAT	PWR	-	-	
	-		O	FAN3OUT	7 8	FAN3IN	I	-	-	
	-	-	PWR	SB3V3	9 10	SB5V	PWR	-	-	
	-		IOT	GPIO0	11 12	GPIO1	IOT		-	
	-		IOT	GPIO2	13 14	GPIO3	IOT		-	
	-		IOT	GPIO4	15 16	GPIO5	IOT		-	
	-		IOT	GPIO6	17 18	GPIO7	IOT		-	
	-	-	PWR	GND	19 20	GND	PWR	-	-	
	-		I	GPIO8	21 22	GPIO9	I		-	
	-		I	GPIO10	23 24	GPIO11	I		-	
	-		I	GPIO12	25 26	GPIO13	IOT		-	
	-		IOT	GPIO14	27 28	GPIO15	IOT		-	
	-		IOT	GPIO16	29 30	GPIO17	IOT		-	
	-	-	PWR	GND	31 32	GND	PWR	-	-	
	-	8/8mA	O	EGCLK	33 34	EGCS#	O	8/8mA	-	
	-	8/8mA		EGAD	35 36	TMA0	O			
	-		PWR	+12V	37 38	GND	PWR	-	-	
	-		O	FAN4OUT	39 40	FAN4IN	I	-	-	
	-	-	PWR	GND	41 42	GND	PWR	-	-	
	-	-	PWR	GND	43 44	S3#	O	25/25mA	-	

- Notes:** 1. Pull-up to +3V3Dual (+3V3 or SB3V3).  
 2. Pull-up to on-board Battery.  
 3. Pull-up to +3V3.

Available cable kit:

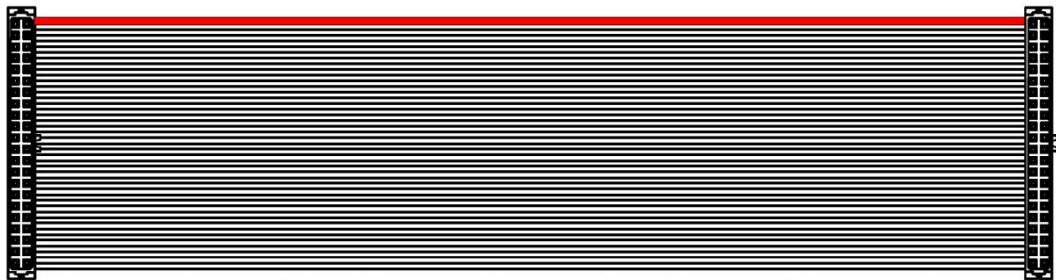

PN 1052-5885 Cable, Feature 44pol 1 to1, 300mm

Signal	Description
CASE_OPEN#	CASE OPEN, used to detect if the system case has been opened. This signal's status is readable, so it may be used like a GPI when the Intruder switch is not required.
SMBC	SMBus Clock signal
SMBD	SMBus Data signal
S3#	S3 sleep mode, active low output, optionally used to deactivate external system.
S5#	S5 sleep mode, active low output, optionally used to deactivate external system.
PWR_OK	PoWeR OK, signal is high if no power failures are detected. (This is not the same as the P_OK signal generated by ATX PSU).
EXT_BAT	(EXTeRnal BATtery) option for connecting + terminal of an external primary cell battery (2.5 - 3.47 V) (- terminal connected to GND). The external battery is protected against charging and can be used with/without the on-board battery installed.
FAN3OUT	FAN 3 speed control OUTput, 3.3V PWM signal can be used as Fan control voltage.
FAN3IN	FAN3 Input. 0V to +3V3 amplitude Fan 3 tachometer input.
FAN4OUT	FAN 4 speed control OUTput, 3.3V PWM signal can be used as Fan control voltage.
FAN4IN	FAN4 Input. 0V to +3V3 amplitude Fan 3 tachometer input.
SB3V3	Max. load is 0.75A (1.5A < 1 sec.)
SB5V	StandBy +5V supply.
GPIO0..17	General Purpose Inputs / Output. These Signals may be controlled or monitored through the use of the KT-API-V2 (Application Programming Interface).
EGCLK	Extend GPIO Clock signal
EGAD	Extend GPIO Address Data signal
EGCS#	Extend GPIO Chip Select signal, active low
TMA0	Timer Output
+12V	Max. load is 0.75A (1.5A < 1 sec.)

Available Temperature Sensor cable kit (for System Fan Temperature Cruise, selected in BIOS):

Based on Maxim DS18B20, Accurate to  $\pm 0.5^{\circ}\text{C}$  over the range of  $-10^{\circ}\text{C}$  to  $+85^{\circ}\text{C}$   
 Feature connector 3.3V (Pin 9), GND (Pin 19) and GPIO16 (Pin 29)

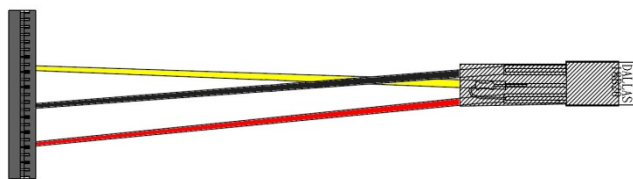

PN1053-4925 Cable Temperature Sensor - 44P, 400 mm

GPIO in more details.

The GPIO's are controlled via the ITE IT8516F Embedded Controller. Each GPIO has 100pF to ground, clamping Diode to 3V3 and has multiplexed functionality. Some pins can be DAC (Digital to Analogue Converter output), PWM (Pulse Width Modulated signal output), ADC (Analogue to Digital Converter input), TMRI (Timer Counter Input), WUI (Wake Up Input), RI (Ring Indicator Input) or some special function.

Signal	IT8516F pin name	Type	Description
GPIO0	DAC0/GPJ0	AO/IOS	
GPIO1	DAC1/GPJ1	AO/IOS	
GPIO2	DAC2/GPJ2	AO/IOS	
GPIO3	DAC3/GPJ3	AO/IOS	
GPIO4	PWM2/GPA2	O8/IOS	
GPIO5	PWM3/GPA3	O8/IOS	
GPIO6	PWM4/GPA4	O8/IOS	
GPIO7	PWM5/GPA5	O8/IOS	
GPIO8	ADC0/GPI0	AI/IS	
GPIO9	ADC1/GPI1	AI/IS	
GPIO10	ADC2/GPI2	AI/IS	
GPIO11	ADC3/GPI3	AI/IS	
GPIO12	ADC4/WUI28/GPI4	AI/IS/IS	
GPIO13	RI1#/WUI0/GPD0	IS/IS/IOS	
GPIO14	RI2#/WUI1/GPD1	IS/IS/IOS	
GPIO15	TMRI0/WUI2/GPC4	IS/IS/IOS	
GPIO16	TMRI1/WUI3/GPC6	IS/IS/IOS	
GPIO17	L80HLAT/BAO/WUI24/GPE0	O4/O4/IS/IOS	

Feature Break-out board:

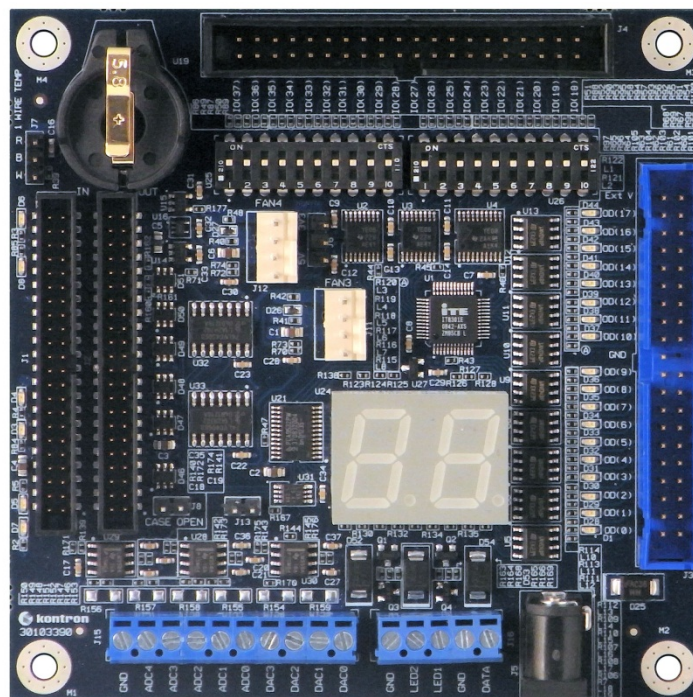

PN 820978 Feature BOB (Break-Out-Board)

## 6.11 “Load Default BIOS Settings” Jumper (J37)

The “Load Default BIOS Settings” Jumper (J37) can be used to recover from incorrect BIOS settings. As an example, incorrect BIOS settings causing no display to turn on can be erased by the Jumper.

The Jumper has 3 positions: Pin 1-2, Pin2-3 (default position) and not mounted.



**Warning**

Don't leave the jumper in position 1-2, otherwise if power is disconnected, the battery will fully deplete within a few weeks.

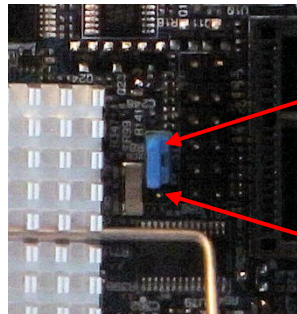

Jumper (in default position)

J37 pin 1

### BIOS version 12 and above:

J37		Description
pin1-2	pin2-3	
X	-	Don't use. (Board do not boot with jumper in this position)
-	X	Default position
-	-	Load Default BIOS Settings and erase Password

To **Load Default BIOS Settings**, inclusive erasing password:

1. Turn off power completely (no SB5V).
2. Remove the Jumper completely from J37.
3. Turn on power.
4. Motherboard beeps fast 20 times and turns off.
5. Turn off power.
6. Move the Jumper back to position 2-3 (default position).
7. Turn on power (use the Power On Button if required to boot).

Motherboard might automatically reboot a few times. Wait until booting is completed.

### BIOS version below 12:

J37		Description
pin1-2	pin2-3	
X	-	Load Default BIOS Settings exclusive erasing Password
-	X	Default position
-	-	No function

To **Load Default BIOS Settings**, exclusive erasing Password and RTC:

1. Turn off power completely (no SB5V).
2. Move the Jumper to pin 1-2 for ~10 seconds.
3. Move the Jumper back to position 2-3 (default position).
4. Turn on power (use the Power On Button if required to boot).
5. Motherboard might automatically reboot a few times. Wait until booting is completed.

## 6.12 SPI Recover Jumper (J4)

The SPI Recover Jumper (J4) is used to select BIOS Recovery Flash instead of BIOS Default Flash. By default the J4 is not installed.

It is recommended that Jumper is plugged to J4 only in case the Default BIOS is corrupted, so that board is malfunctioning and do not boot, or the Recovery BIOS is requested to be upgraded in order to have sufficient or same support as the default BIOS.

In case Default BIOS seems corrupted then it is recommend to first trying to use the Load Default BIOS Settings Jumper, see previous page.

When using customised BIOS it is recommended to upgrade both the Default BIOS and the Recovery BIOS with the Customised BIOS.

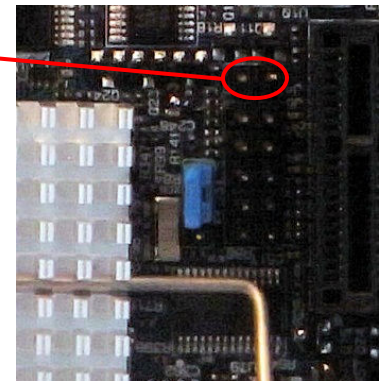

Recover corrupted Default BIOS procedure:

1. Turn off power.
2. Install "SPI Recover Jumper"(J4).
3. Reboot.
4. Remove "SPI Recover Jumper".
5. Upgrade the BIOS (fx. execute Upd.bat, containing: BF safewrite xxxxxx.xxx).
6. When BIOS upgrade is completed then turn off power completely (inclusive Standby +5V).
7. Wait minimum 10 seconds.
8. Turn on power. System will automatically reboot 4-5 times within 1 minute.

Upgrade Recovery BIOS procedure:

1. Reboot.
2. Install "SPI Recover Jumper"(J4).
3. Upgrade the BIOS (fx. execute UpdRec.bat, containing: BF safewrite xxxxxx.xxx RECOVERY).
4. When BIOS upgrade is completed then turn off power completely (inclusive Standby +5V).
5. Wait minimum 10 seconds.
6. Turn on power. System will automatically reboot 4-5 times within 1 minute.
7. If boot succeed then remove "SPI Recover Jumper".

Upgrade first Default BIOS and then Recovery BIOS with Customised BIOS procedure:

1. Reboot.
2. Upgrade the BIOS (fx. execute Upd.bat).
3. When BIOS upgrade is completed then turn off power completely (inclusive Standby +5V).
4. Wait minimum 10 seconds.
5. Turn on power. System will automatically reboot 4-5 times within 1 minute.
6. Install "SPI Recover Jumper"(J4).
7. Upgrade the BIOS (fx. execute UpdRec.bat).
8. When BIOS upgrade is completed then turn off power completely (inclusive Standby +5V).
9. Wait minimum 10 seconds.
10. Turn on power. System will automatically reboot 4-5 times within 1 minute.
11. Remove "SPI Recover Jumper".

Note: It is not recommended to upgrade both Default BIOS and Recovery BIOS without rebooting and verification in between, unless you are sure that BIOS and tools works correctly. Otherwise there is a risk that both BIOS will be corrupted at the same time with the result that board cannot be recovered.

### 6.13 SPI Connector (SPI) (J5)

The SPI Connector is normally not used. If however a SPI BIOS is connected via the SPI Connector then the board will try to boot on it.

Note	Pull U/D	Ioh/Iol	Type	Signal	PIN	Signal	Type	Ioh/Iol	Pull U/D	Note
	-			CLK	1 2	SB3V3	PWR	-	-	
	-		I	CS0#	3 4	ADDIN	IO		/10K	
	10K/		-	NC	5 6	NC	-	-	-	
	10K/		IO	MOSI	7 8	ISOLATE#	IO		100K	
	-		IO	MISO	9 10	GND	PWR	-	-	

Signal	Description
CLK	Serial Clock
SB3V3	3.3V Standby Voltage power line. Normally output power, but when Motherboard is turned off then the on-board SPI Flash can be 3.3V power sourced via this pin.
CS0#	CS0# Chip Select 0, active low.
ADDIN	ADDIN input signal must be NC.
MOSI	Master Output, Slave Input
ISOLATE#	The ISOLATE# input, active low, is normally NC, but must be connected to GND when loading SPI flash. Power Supply to the Motherboard must be turned off when loading SPI flash. The pull up resistor is connected via diode to 5VSB.
MISO	Master Input, Slave Output



## 6.14 XDP-CPU (Debug Port for CPU) (J32)

The XDP-CPU (Intel Debug Port for CPU) connector is not mounted and not supported. XDP connector layout (pads) is located on the backside of PCB and is prepared for the Molex 52435-2671 (or 52435-2672).

Pin	Signal	Description	Type	Pull Up/Down	Note
1	OBSFN_A0				
2	OBSFN_A1				
3	GND		PWR	-	
4	NC		NC	-	
5	NC		NC	-	
6	GND		PWR	-	
7	NC		NC	-	
8	NC		NC	-	
9	GND		PWR	-	
10	HOOK0				
11	HOOK1				
12	HOOK2				
13	HOOK3				
14	HOOK4				
15	HOOK5				
16	+5V		PWR	-	
17	HOOK6				
18	HOOK7			500R	(500R by 2x1K in parallel)
19	GND		PWR	-	
20	TDO			/51R	
21	TRST#			/51R	
22	TDI			/51R	
23	TMS			/51R	
24	NC		NC	-	
25	GND		PWR	-	
26	TCK0			/51R	

## 6.15 XDP-PCH (Debug Port for Chipset) (J33)

The XDP-PCH (Intel Debug Port for Chipset) connector is not mounted and not supported. XDP-PCH connector layout (pads) is located on the backside of PCB (below J35 connector on mITX version) and is prepared for the Molex 52435-2671 (or 52435-2672).

Pin	Signal	Description	Type	Pull Up/Down	Note
1	NC		NC	-	
2	NC		NC	-	
3	GND		PWR	-	
4	NC		NC	-	
5	NC		NC	-	
6	GND		PWR	-	
7	NC		NC	-	
8	NC		NC	-	
9	GND		PWR	-	
10	HOOK0	RSMRST#			Connected to HOOK6
11	HOOK1	PWRBTN#			
12	HOOK2		NC	-	
13	HOOK3		NC	-	
14	HOOK4		NC	-	
15	HOOK5		NC	-	
16	+5V		PWR	-	
17	HOOK6				Connected to HOOK1
18	HOOK7	RESET#		500R	(500R by 2x1K in parallel)
19	GND		PWR	-	
20	TDO			210R/100R	
21	TRST#				
22	TDI			210R/100R	
23	TMS			210R/100R	
24	NC		NC	-	
25	GND		PWR	-	
26	TCK0			/51R	

## 7 Slot Connectors (PCIe, miniPCIe, PCI)

### 7.1 PCIe Connectors

All members of the KTQM77 family supports one (x16) (16-lane) PCI Express port, one x1 PCI Express port and two miniPCI Express ports.

The **16-lane (x16) PCI Express** (PCIe 2.0 and PCIe 3.0) port can be used for external PCI Express cards inclusive graphics card. Maximum theoretical bandwidth using 16 lanes is 16 GB/s. PCIe x1, PCIe x2, PCIe x4, PCIe x8 and PCIe x16 are supported; however PCIe x2 is only supported when using 3rd generation Intel® Core™ processor (Ivy Bridge).

The two **miniPCIe** (PCIe 2.0) is located on the backside of the board.

The **1-lane (x1) PCI Express** (PCIe 2.0) can be used for any PCIe x1 cards inclusive “Riser PCIe x1 to PCI Dual flexible card”.

#### 7.1.1 PCI-Express x16 Connector (PCIe x16)

Note	Type	Signal	PIN		Signal	Type	Note
		+12V	B1	A1	NC		
		+12V	B2	A2	+12V		
		+12V	B3	A3	+12V		
		GND	B4	A4	GND		
		SMB_CLK	B5	A5	NC		
		SMB_DATA	B6	A6	NC		
		GND	B7	A7	NC		
		+3V3	B8	A8	NC		
		NC	B9	A9	+3V3		
		SB3V3	B10	A10	+3V3		
		WAKE#	B11	A11	RST#		
		NC	B12	A12	GND		
		GND	B13	A13	PCIE_x16 CLK		
		PEG_TXP[0]	B14	A14	PCIE_x16 CLK#		
		PEG_TXN[0]	B15	A15	GND		
		GND	B16	A16	PEG_RXP[0]		
		CLKREQ	B17	A17	PEG_RXN[0]		
		GND	B18	A18	GND		
		PEG_TXP[1]	B19	A19	NC		
		PEG_TXN[1]	B20	A20	GND		
		GND	B21	A21	PEG_RXP[1]		
		GND	B22	A22	PEG_RXN[1]		
		PEG_TXP[2]	B23	A23	GND		
		PEG_TXN[2]	B24	A24	GND		
		GND	B25	A25	PEG_RXP[2]		
		GND	B26	A26	PEG_RXN[2]		
		PEG_TXP[3]	B27	A27	GND		
		PEG_TXN[3]	B28	A28	GND		
		GND	B29	A29	PEG_RXP[3]		
		NC	B30	A30	PEG_RXN[3]		
		CLKREQ	B31	A31	GND		
		GND	B32	A32	NC		
		PEG_TXP[4]	B33	A33	NC		
		PEG_TXN[4]	B34	A34	GND		
		GND	B35	A35	PEG_RXP[4]		

		GND	B36	A36	PEG_RXN[4]		
		PEG_TXP[5]	B37	A37	GND		
		PEG_TXN[5]	B38	A38	GND		
		GND	B39	A39	PEG_RXP[5]		
		GND	B40	A40	PEG_RXN[5]		
		PEG_TXP[6]	B41	A41	GND		
		PEG_TXN[6]	B42	A42	GND		
		GND	B43	A43	PEG_RXP[6]		
		GND	B44	A44	PEG_RXN[6]		
		PEG_TXP[7]	B45	A45	GND		
		PEG_TXN[7]	B46	A46	GND		
		GND	B47	A47	PEG_RXP[7]		
		CLKREQ	B48	A48	PEG_RXN[7]		
		GND	B49	A49	GND		
		PEG_TXP[8]	B50	A50	NC		
		PEG_TXN[8]	B51	A51	GND		
		GND	B52	A52	PEG_RXP[8]		
		GND	B53	A53	PEG_RXN[8]		
		PEG_TXP[9]	B54	A54	GND		
		PEG_TXN[9]	B55	A55	GND		
		GND	B56	A56	PEG_RXP[9]		
		GND	B57	A57	PEG_RXN[9]		
		PEG_TXP[10]	B58	A58	GND		
		PEG_TXN[10]	B59	A59	GND		
		GND	B60	A60	PEG_RXP[10]		
		GND	B61	A61	PEG_RXN[10]		
		PEG_TXP[11]	B62	A62	GND		
		PEG_TXN[11]	B63	A63	GND		
		GND	B64	A64	PEG_RXP[11]		
		GND	B65	A65	PEG_RXN[11]		
		PEG_TXP[12]	B66	A66	GND		
		PEG_TXN[12]	B67	A67	GND		
		GND	B68	A68	PEG_RXP[12]		
		GND	B69	A69	PEG_RXN[12]		
		PEG_TXP[13]	B70	A70	GND		
		PEG_TXN[13]	B71	A71	GND		
		GND	B72	A72	PEG_RXP[13]		
		GND	B73	A73	PEG_RXN[13]		
		PEG_TXP[14]	B74	A74	GND		
		PEG_TXN[14]	B75	A75	GND		
		GND	B76	A76	PEG_RXP[14]		
		GND	B77	A77	PEG_RXN[14]		
		PEG_TXP[15]	B78	A78	GND		
		PEG_TXN[15]	B79	A79	GND		
		GND	B80	A80	PEG_RXP[15]		
		CLKREQ	B81	A81	PEG_RXN[15]		
		NC	B82	A82	GND		

### 7.1.2 miniPCI-Express mPCIe0 (J34)

The miniPCI Express port mPCIe0 is located on the backside.

Beside miniPCIe cards the mPCIe0 also supports mSATA SSD cards.

SATA2 is used for mSATA signals.

Note: no USB signals are available.



Note	Type	Signal	PIN		Signal	Type	Note
		WAKE#	1	2	+3V3	PWR	
	NC	NC	3	4	GND	PWR	
	NC	NC	5	6	+1.5V	PWR	
1		CLKREQ#	7	8	NC	NC	
	PWR	GND	9	10	NC	NC	
		PCIE_mini CLK#	11	12	NC	NC	
		PCIE_mini CLK	13	14	NC	NC	
	PWR	GND	15	16	NC	NC	
	NC	NC	17	18	GND	PWR	
	NC	NC	19	20	W_Disable#		2
	PWR	GND	21	22	RST#		
		PCIE_RXN	23	24	+3V3 Dual	PWR	
		PCIE_RXP	25	26	GND	PWR	
	PWR	GND	27	28	+1.5V	PWR	
	PWR	GND	29	30	SMB_CLK		
		PCIE_TXN	31	32	SMB_DATA		
		PCIE_TXP	33	34	GND	PWR	
	PWR	GND	35	36	NC	NC	
	PWR	GND	37	38	NC	NC	
	PWR	+3V3 Dual	39	40	GND	PWR	
	PWR	+3V3 Dual	41	42	NC	NC	
	PWR	GND	43	44	NC	NC	
		CLK_MPCIE	45	46	NC	NC	
		DATA_MPCIE	47	48	+1.5V	PWR	
		RST_MPCIE#	49	50	GND	PWR	
3		SEL_MSATA	51	52	+3V3 Dual	PWR	

**Note 1:** 10K ohm pull-up to 3V3.

**Note 2:** 2K2 ohm pull-up to 3V3 Dual.

**Note 3:** 100K ohm pull-up to 1V8 (S0 mode)

### 7.1.3 miniPCI-Express mPCIe1 (J35)

The miniPCI Express port mPCIe1 is located on the backside.

Note: no USB and no mSATA signals are available.

Note	Type	Signal	PIN		Signal	Type	Note
		WAKE#	1	2	+3V3	PWR	
	NC	NC	3	4	GND	PWR	
	NC	NC	5	6	+1.5V	PWR	
1		CLKREQ#	7	8	NC	NC	
	PWR	GND	9	10	NC	NC	
		PCIE_mini CLK#	11	12	NC	NC	
		PCIE_mini CLK	13	14	NC	NC	
	PWR	GND	15	16	NC	NC	
	NC	NC	17	18	GND	PWR	
	NC	NC	19	20	W_Disable#		2
	PWR	GND	21	22	RST#		
		PCIE_RXN	23	24	+3V3 Dual	PWR	
		PCIE_RXP	25	26	GND	PWR	
	PWR	GND	27	28	+1.5V	PWR	
	PWR	GND	29	30	SMB_CLK		
		PCIE_TXN	31	32	SMB_DATA		
		PCIE_TXP	33	34	GND	PWR	
	PWR	GND	35	36	NC	NC	
	NC	NC	37	38	NC	NC	
	NC	NC	39	40	GND	PWR	
	NC	NC	41	42	NC	NC	
	NC	NC	43	44	NC	NC	
	NC	NC	45	46	NC	NC	
	NC	NC	47	48	+1.5V	PWR	
	NC	NC	49	50	GND	PWR	
	NC	NC	51	52	+3V3	PWR	

**Note 1:** 10K ohm pull-up to 3V3 Dual.

**Note 2:** 2K2 ohm pull-up to 3V3 Dual.

### 7.1.4 PCI-Express x1 Connector (PCIe x1) (J36)

The KTQM77/mITX supports one PCIe x1.

Note	Type	Signal	PIN		Signal	Type	Note
	PWR	+12V	B1	A1	GND	PWR	
	PWR	+12V	B2	A2	+12V	PWR	
	PWR	+12V	B3	A3	+12V	PWR	
	PWR	GND	B4	A4	GND	PWR	
		SMB_CLK	B5	A5	NC		
		SMB_DATA	B6	A6	NC		
	PWR	GND	B7	A7	NC		
	PWR	+3V3	B8	A8	NC		
2		JTAG_TEST#	B9	A9	+3V3	PWR	
	PWR	3V3 Dual	B10	A10	+3V3	PWR	
		WAKE#	B11	A11	RST#		
	NC	NC	B12	A12	GND	PWR	
	PWR	GND	B13	A13	PCIE_CLK_P		
		PCIE_TXP	B14	A14	PCIE_CLK_N		
		PCIE_TXN	B15	A15	GND	PWR	
	PWR	GND	B16	A16	PCIE_RXP		
1		CLK_REQ	B17	A17	PCIE_RXN		
	PWR	GND	B18	A18	GND	PWR	

**Note 1:** 10K ohm pull-up to 3V3 Dual.

**Note 2:** 4K7 ohm pull-down to GND.

## 8 On-board - & mating connector types

The Mating connectors / Cables are connectors or cable kits which are fitting the On-board connector. The highlighted cable kits are included in the "KTQM67 Cable & Driver Kit" PN 826598, in different quantities depending on type of connector. For example there is 4 x 821017 COM cables and 6 x 821035 SATA cables.

Connector	On-board Connectors		Mating Connectors / Cables	
	Manufacturer	Type no.	Manufacturer	Type no.
FAN_CPU	Foxconn	HF2704E-M1	AMP	1375820-4 (4-pole)
FAN_SYS	AMP	1470947-1	AMP	1375820-3 (3-pole)
KBDMSE	Molex	22-23-2061	Molex	22-01-2065
			Kontron	<b>KT 1046-3381</b> KT 1053-2384
CDROM	Foxconn	HF1104E	Molex	50-57-9404
	Molex	70543-0038		
SATA	Hon Hai	LD1807V-S52T	Molex	67489-8005
			Kontron	<b>KT 821035</b> (cable kit)
ATXPWR	Molex	44206-0002	Molex	5557-24R
ATX+12V-4pin	Lotes	ABA-POW-003-K02	Molex	39-01-2045
EDP	Tyco	5-2069716-3	Tyco	2023344-3
LVDS	Don Connex	C44-40BSB1-G	Don Connex	A32-40-C-G-B-1
			Kontron	KT 910000005
			Kontron	<b>KT 821515</b> (cable kit)
			Kontron	KT 821155 (cable kit)
COM1,2, 3, 4	Wuerth	61201020621	Molex	90635-1103
			Kontron	KT 821016 (cable kit)
			Kontron	<b>KT 821017</b> (cable kit)
USB6/8/9, 10/11, 12/13	Pinrex	512-90-10GBB2	Kontron	<b>KT 821401</b> (cable kit)
USB6/7 (*)	(FRONTPNL)	-	Kontron	<b>KT 821401</b> (cable kit)
IEEE1394_0/1	Foxconn	HS1105F-RNP9	Kontron	<b>KT 821040</b> (cable kit)
AUDIO_HEAD	Molex	87831-2620	Molex	51110-2651
			Kontron	<b>KT 821043</b> (cable kit)
FRONTPNL	Pinrex	512-90-24GBB3	Molex	90635-1243
			Kontron	<b>KT 821042</b> (cable kit)
FEATURE	Foxconn	HS5422F	Don Connex	A05c-44-B-G-A-1-G

\* USB6/USB7 is located in FRONTPNL connector. Depending on application KT 821401 can be used.

**Notes:** Only one connector will be mentioned for each type of on-board connector even though several types with same fit, form and function are approved and could be used as alternative. Please also notice that standard connectors like DVI, DP, PCIe, miniPCIe, Audio Jack, Ethernet and USB is not included in the list.

The KTHM76/mITX do not support: EDP, USB6/7 and IEEE1394\_0/1.



## 9 System Resources

### 9.1 Memory Map

Address (hex)		Size (hex)	Description
0xFF000000	0xFFFFFFFF	1000000	Intel® 82802 Firmware Hub Device Motherboard resources
0xFEE00000	0xFEEFFFFFFF	100000	Motherboard resources
0xFED90000	0xFED93FFF	4000	Motherboard resources
0xFED45000	0xFED8FFFF	4B000	Motherboard resources
0xFED40000	0xFED44FFF	5000	System board
0xFED20000	0xFED3FFFF	20000	Motherboard resources
0xFED1C000	0xFED1FFFF	4000	Motherboard resources
0xFED19000	0xFED19FFF	1000	Motherboard resources
0xFED18000	0xFED18FFF	1000	Motherboard resources
0xFED10000	0xFED17FFF	8000	Motherboard resources
0xFED00000	0xFED003FF	400	High Precision Event Timer
0xF8000000	0xFBFFFFFFF	4000000	Motherboard resources
0xF7F3B000	0xF7F3B00F	10	Intel® Management Engine Interface
0xF7F39000	0xF7F39FFF	1000	Intel® 82579LM Gigabit Network
0xF7F38000	0xF7F383FF	400	Intel® Chipset USB EHCI - 1E2D
0xF7F37000	0xF7F373FF	400	Intel® Chipset USB EHCI - 1E26
0xF7F36000	0xF7F367FF	800	Intel® Chipset 6 port SATA ACHI - 1E03
0xF7F35000	0xF7F350FF	100	Intel® Chipset SMBus Controller - 1E22
0xF7F30000	0xF7F33FFF	4000	High Definition Audio Controller
0xF7F00000	0xF7F1FFFF	20000	Intel® 82579LM Gigabit Network
0xF7E00000	0xF7EFFFFFFF	100000	Intel® Chipset PCIe Root port 3 - 1E14
0xF7D00000	0xF7DFFFFFFF	100000	Intel® Chipset PCIe Root port 4 - 1E16
0xF7C00000	0xF7CFFFFFFF	100000	Intel® Chipset PCIe Root port 6 - 1E1A
0xF7800000	0xF7BFFFFFFF	400000	Intel® HD Graphics 4000 Family
0xE0000000	0xEFFFFFFF	10000000	Intel® HD Graphics 4000 Family
0xDFA00000	0xDFA00FFF	1000	Motherboard resources PCI bus
0x40000000	0x401FFFFFFF	200000	System board
0x20000000	0x201FFFFFFF	200000	System board
0xE4000	0xE7FFF	4000	PCI bus
0xE0000	0xE3FFF	4000	PCI bus
0xDC000	0xDFFFF	4000	PCI bus
0xD8000	0xDBFFF	4000	PCI bus
0xD4000	0xD7FFF	4000	PCI bus
0xD0000	0xD3FFF	4000	PCI bus
0xA0000	0xBFFFF	20000	Intel® HD Graphics Family PCI bus

### 9.3 Interrupt Usage

IRQ	System timer	PS/2 Keyboard	COM2 Selection in BIOS	COM1 Selection in BIOS	COM4 Selection in BIOS	System CMOS/real-time watch	COM3 Selection in BIOS	Intel(R) SMBus -1E22	PS2 Mouse	Numerical Data Processor	Intel(R) USB EHCI – 1E2D	Intel(R) PCIe Root Port 1 – 1E10	Intel(R) Management Engine Interface	Intel(R) PCIe Root Port 6 – 1E1A	LSI 1394 OHCI Host	Intel(R) PCIe Root Port 3 – 1E14	Intel(R) PCIe Root Port 4 – 1E16	Intel(R) SATA ACHI – 1E03	High Definition Audio	Intel(R) USB EHCI – 1E26	Notes
NMI																					
IRQ0	X																				
IRQ1		X																			
IRQ2																					
IRQ3			X																		
IRQ4				X																	
IRQ5																					
IRQ6																					
IRQ7					X																
IRQ8						X															
IRQ9																					
IRQ10							X														
IRQ11								X													
IRQ12									X												
IRQ13										X											
IRQ14																					
IRQ15																					
IRQ16											X	X	X								
IRQ17														X	X						
IRQ18																X					
IRQ19																	X	X			
IRQ20																					
IRQ21																					
IRQ22																			X		
IRQ23																				X	
IRQ24																					
IRQ25																					
IRQ26																					

## 9.4 IO Map

Address range (hex)		Size (hex)	Description
0x0000FFFF	0x0000FFFF	1	Motherboard resources
0x0000F0D0	0x0000F0D7	8	Intel® 7 port SATA AHCI - 1E03
0x0000F0C0	0x0000F0C3	4	Intel® 7 port SATA AHCI - 1E03
0x0000F0B0	0x0000F0B7	8	Intel® 7 port SATA AHCI - 1E03
0x0000F0A0	0x0000F0A3	4	Intel® 7 port SATA AHCI - 1E03
0x0000F060	0x0000F07F	20	Intel® 7 port SATA AHCI - 1E03
0x0000F040	0x0000F05F	20	Intel® SMBus - 1E22
0x0000F000	0x0000F03F	40	Intel® HD Graphics 4000 family
0x0000E000	0x0000EFFF	1000	Intel® PCIe Root port 3 - 1E14
0x0000D000	0x0000DFFF	1000	Intel® PCIe Root port 4 - 1E16
0x0000164E	0x0000164F	2	Motherboard resources
0x00001000	0x0000100F	10	Motherboard resources
0x00000F78	0x00000F7F	8	Motherboard resources
0x00000B78	0x00000B7F	8	Motherboard resources
0x00000A00	0x00000A2F	30	Motherboard resources
0x00000778	0x0000077F	8	Motherboard resources
0x00000680	0x0000069F	20	Motherboard resources
0x00000500	0x0000057F	80	Motherboard resources
0x000004D0	0x000004D1	2	Programmable interrupt controller Motherboard resources
0x00000458	0x0000047F	28	Motherboard resources
0x00000454	0x00000457	4	Motherboard resources
0x00000400	0x00000453	54	Motherboard resources
0x000003F8	0x000003FF	8	COM1
0x000003E8	0x000003EF	8	COM4
0x000003C0	0x000003DF	20	Intel® HD Graphics 4000 family
0x000003B0	0x000003BB	C	Intel® HD Graphics 4000 family
0x00000378	0x0000037F	8	Printer port LPT1
0x000002F8	0x000002FF	8	COM2
0x000002E8	0x000002EF	8	COM3
0x00000290	0x0000029F	10	Motherboard resources
0x0000020E	0x0000020F	2	Motherboard resources
0x000000F0	0x000000FF	10	Numeric data processor
0x000000E0	0x000000EF	10	Motherboard resources
0x000000C0	0x000000DF	20	Direct memory access controller
0x000000A2	0x000000BF	1E	Motherboard resources
0x000000A0	0x000000A1	2	Programmable interrupt controller
0x00000081	0x00000091	10	Direct memory access controller
0x00000072	0x00000080	E	Motherboard resources
0x00000070	0x00000077	8	System CMOS/real time clock
0x00000067	0x00000067	1	Motherboard resources
0x00000065	0x00000065	1	Motherboard resources
0x00000064	0x00000064	1	Standard PS/2 Keyboard
0x00000063	0x00000063	1	Motherboard resources
0x00000061	0x00000061	1	Motherboard resources
0x00000060	0x00000060	1	Standard PS/2 Keyboard
0x00000044	0x0000005F	1C	Motherboard resources
0x00000040	0x00000043	4	System Timer
0x00000022	0x0000003F	1E	Motherboard resources
0x00000022	0x00000023	2	Motherboard resources
0x00000020	0x00000021	2	Programmable interrupt controller
0x00000000	0x0000001F	20	Direct memory access controller PCI bus

## 10 BIOS

The BIOS Setup is used to view and configure BIOS settings for the board. The BIOS Setup is accessed by pressing the <Del> -key after the Power-On Self-Test (POST) memory test begins and before the operating system boot begins.

The BIOS settings will be loaded automatically when loading *Restore Default* see *Save & Exit* menu. In this Users Guide the default settings are indicated by **bold**. Please notice that *Restore User Defaults* might have different set of default values.

### 10.1 Main

Aptio Setup Utility – Copyright © 2012 American Megatrends, Inc.

Main | Advanced | Chipset | Boot | Security | Save & Exit

<b>BIOS Information</b> BIOS Vendor: American Megatrends Core Version: 4.6.5.3 Compliancy: UEFI 2.3; PI 1.2 BIOS Version: 15 Build Date and Time: 12/19/2013 07:42:40 EC Firmware Version: V1.21 07/05/13		Set the Date. Use Tab to switch between Date elements.
<b>Board Information</b> Product Name: KTQM77/mITX PCB ID: 00 Serial #: 01092087 Part #: 64800000 Boot Count: 452		
System Date: [Mon 12/30/2013] System Time: [11:30:40]		→← : Select Screen ↑↓ : Select Item Enter: Select +/- : Change Opt. F1: General Help F2: Previous Values F3: Optimized Defaults F4: Save & Exit ESC: Exit
Access Level: Administrator		

Version 2.15.1226. Copyright © 2012 American Megatrends, Inc

Blue text for settings that can be changed. White text for actual setting to be changed via the control keys (Black text for settings that cannot be changed via control keys)

Note: Product Name is KTHM76/mITX or KTQM77/mITX depending on actual board type.

The following table describes the changeable settings:

Feature	Options	Description
System Date	MM/DD/YYYY	Set the system date.
System Time	HH:MM:SS	Set the system time.

## 10.2 Advanced

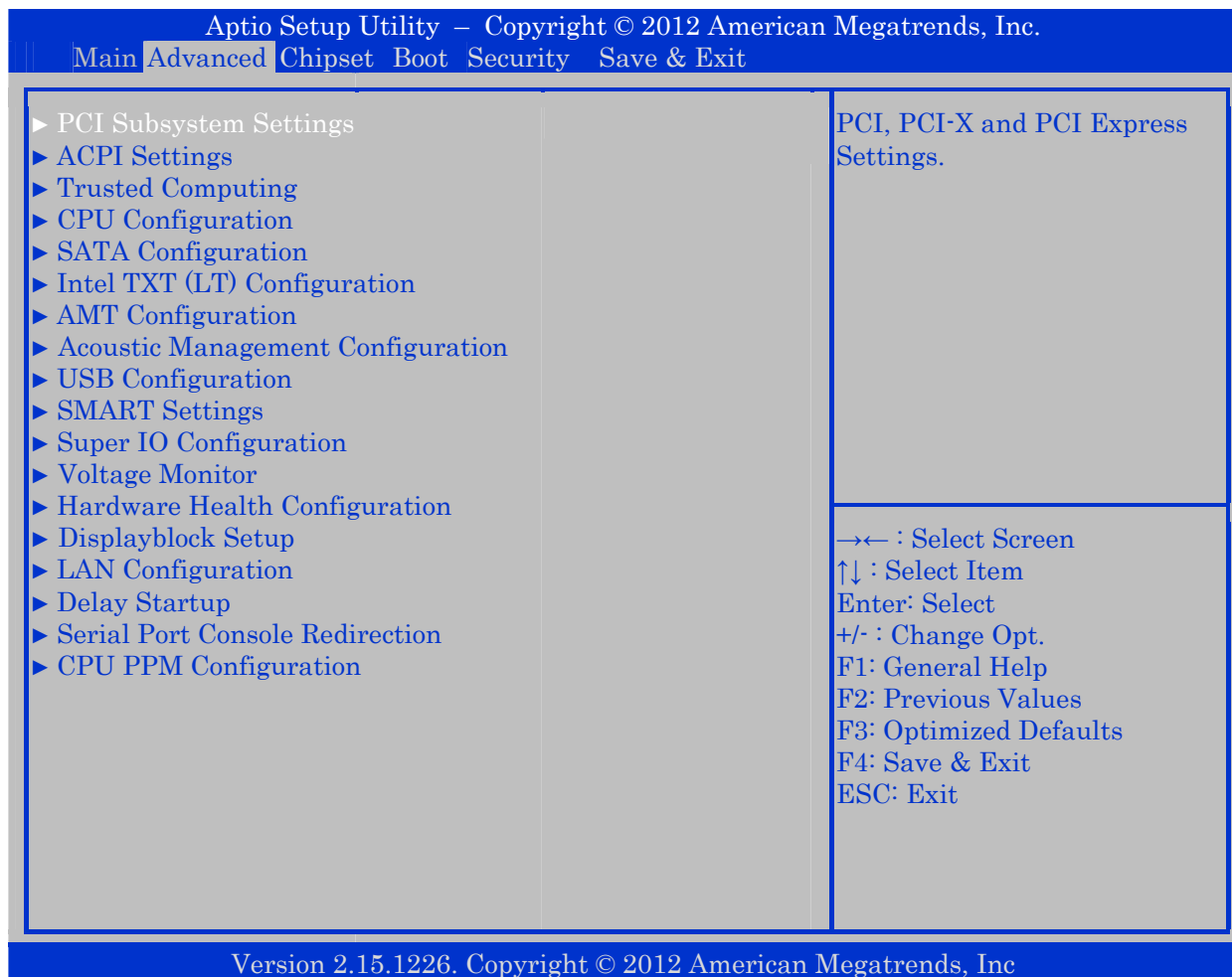

Note: the submenus *Intel TXT (LT) Configuration* and *AMT Configuration* are only present when using KTQM77/mlTX.

The Advanced (main) menu contains only submenu selections which will be described in more details on the following pages.

In order to make a selection of a submenu activated the ↑↓ keys until the requested submenu becomes white color, then activate the <Enter>.

### 10.2.1 Advanced - PCI Subsystem Settings

Aptio Setup Utility – Copyright © 2012 American Megatrends, Inc.

Advanced

PCI Bus Driver Version	V 2.05.02	Enables or Disables 64bit capable Devices to be Decoded in Above 4G Address Space (Only if System Supports 64 bit PCI Decoding).
PCI 64bit Resources Handling Above 4G Decoding	[Disabled]	
▶ PCI Express Settings		→← : Select Screen ↑↓ : Select Item Enter: Select +/- : Change Opt. F1: General Help F2: Previous Values F3: Optimized Defaults F4: Save & Exit ESC: Exit
▶ PCI Express GEN 2 Settings		

Version 2.15.1226. Copyright © 2012 American Megatrends, Inc

Function	Selection	Description
Above 4G Decoding	<b>Disabled</b> Enabled	Enables or Disables 64bit capable Devices to be Decoded in Above 4G Address Space (Only if System Supports 64 bit PCI Decoding).

Note: The selection in **bold** is the default selection.

## 10.2.1.1 PCI Express Settings

Aptio Setup Utility – Copyright © 2012 American Megatrends, Inc.

Advanced

<p>PCI Express Link Register Settings</p> <p>ASPM Support [Disabled]</p> <p>WARNING: Enabling ASPM may cause Some PCI-E devices to fail</p>		<p>Set the ASPM Level: Force L0s - Force all links to L0s State: Auto – BIOS auto configure: Disable – Disabled ASPM</p>
		<p>→← : Select Screen ↑↓ : Select Item Enter: Select +/- : Change Opt. F1: General Help F2: Previous Values F3: Optimized Defaults F4: Save &amp; Exit ESC: Exit</p>

Version 2.15.1226. Copyright © 2012 American Megatrends, Inc

Function	Selection	Description
ASPM Support	<b>Disabled</b> Auto Force L0s	Set the ASPM Level: Force L0s - Force all links to L0s State. Auto – BIOS auto configure Disable – Disabled ASPM

## 10.2.1.2 PCI Express GEN 2 Settings

Aptio Setup Utility – Copyright © 2012 American Megatrends, Inc.

Advanced

PCI Express GEN2 Link Register Settings	
Target Link Speed	[Auto]
<p>If supported by hardware and set to 'Force to 2.5GT/s' for Downstream Ports, this sets an upper limit on Link operational speed by restricting the values advertised by the Upstream component in its training sequences. Ehen 'Auto' is selected HW initialized data will be used.</p> <p>→← : Select Screen            ↑↓ : Select Item            Enter: Select            +/- : Change Opt.            F1: General Help            F2: Previous Values            F3: Optimized Defaults            F4: Save &amp; Exit            ESC: Exit</p>	

Version 2.15.1226. Copyright © 2012 American Megatrends, Inc

Function	Selection	Description
Target Link Speed	<b>Auto</b> Force to 2.5GT/s Force to 5.0GT/s	If supported by hardware and set to 'Force to 2.5GT/s' for Downstream Ports, this sets an upper limit on Link operational speed by restricting the values advertised by the Upstream component in its training sequences. Ehen 'Auto' is selected HW initialized data will be used.



## 10.2.2 Advanced - APCI Settings

Aptio Setup Utility – Copyright © 2012 American Megatrends, Inc.

Advanced

ACPI Settings		Enables or Disables BIOS APCI Auto Configuration.
Enable ACPI Auto Configuration	[Disabled]	
Enable Hibernation ACPI Sleep State	[Enabled] [Both S1 and S3 ava...]	

→← : Select Screen  
 ↑↓ : Select Item  
 Enter: Select  
 +/- : Change Opt.  
 F1: General Help  
 F2: Previous Values  
 F3: Optimized Defaults  
 F4: Save & Exit  
 ESC: Exit

Version 2.15.1226. Copyright © 2012 American Megatrends, Inc

Function	Selection	Description
Enable ACPI Auto Configuration	<b>Disabled</b> Enabled	Enables or Disables BIOS APCI Auto Configuration.
Enable Hibernation	Disabled <b>Enabled</b>	Enables or Disables System ability to Hibernate (OS/S4 Sleep State). This option may be not effective with some OS.
ACPI Sleep State	Suspend Disabled S1 only(CPU Stop Clock) S3 only(Suspend to RAM) <b>Both S1 and S3 available</b> <b>For OS to choose from</b>	Select ACPI sleep state the system will enter when the SUSPEND button is pressed.

## 10.2.3 Advanced - Trusted Computing

Aptio Setup Utility – Copyright © 2012 American Megatrends, Inc.

Advanced

<p>Configuration</p> <p>Security Device Support [Enable]</p> <p>TPM State [Enabled]</p> <p>Pending operation [None]</p> <p>Current Status Information</p> <p>TPM Enabled Status: [Disabled]</p> <p>TPM Active Status: [Deactivated]</p> <p>TPM Owner Status: [Unowned]</p>	<p>Enables or Disables BIOS support for security device. O.S. will not show Security Device. TCG EFI protocol and INT1A interface will not be available.</p>
	<p>→← : Select Screen</p> <p>↑↓ : Select Item</p> <p>Enter: Select</p> <p>+/- : Change Opt.</p> <p>F1: General Help</p> <p>F2: Previous Values</p> <p>F3: Optimized Defaults</p> <p>F4: Save &amp; Exit</p> <p>ESC: Exit</p>

Version 2.15.1226. Copyright © 2012 American Megatrends, Inc

Function	Selection	Description
Security Device Support	<b>Disabled</b> Enabled	Enables or Disables BIOS support for security device. O.S. will not show Security Device. TCG EFI protocol and INT1A interface will not be available.
TPM State	<b>Disabled</b> Enabled	Enable/Disable Security Device. NOTE: Your Computer will reboot during restart in order to change State of the Device.
Pending operation	<b>None</b> Enable Take Ownership Disable Take Ownership TPM Clear	Schedule an Operation for the Security Device. NOTE: Your Computer will reboot during restart in order to change State of the Device.

Note: TPM State and Pending operation are only visible if Security Device Support is Enabled followed by Save and Exit.

## 10.2.4 Advanced - CPU Configuration

Aptio Setup Utility – Copyright © 2012 American Megatrends, Inc.

Advanced

CPU Configuration		<p>Enabled for Windows XP and Linux (OS optimized for Hyper-Threading Technology) and Disabled for other OS (OS not optimized for Hyper-Threading Technology). When Disabled only one thread per enabled core is enabled.</p> <p>→← : Select Screen          ↑↓ : Select Item          Enter: Select          +/- : Change Opt.          F1: General Help          F2: Previous Values          F3: Optimized Defaults          F4: Save &amp; Exit          ESC: Exit</p>
Intel® Core™ i5-3610ME CPU @	2.70GHz	
CPU Signature	306a8	
Microcode Patch	10	
Max CPU Speed	2700 MHz	
Min CPU Speed	1200 MHz	
CPU Speed	2700 MHz	
Processor Cores	2	
Intel HT Technology	Supported	
Intel VT-x Technology	Supported	
Intel SMX Technology	Supported	
64-bit	Supported	
L1 Data Cache	32 kB x 2	
L1 Code Cache	32 kB x 2	
L2 Cache	256 kB x 2	
L3 Cache	3072 kB	
Hyper-threading	[Enabled]	
Active Processor Cores	[All]	
Limit CPUID Maximum	[Disabled]	
Execute Disable Bit	[Enabled]	
Intel Virtualization Technology	[Disabled]	

Version 2.15.1226. Copyright © 2012 American Megatrends, Inc

Function	Selection	Description
Hyper-threading (Note1)	Disabled <b>Enabled</b>	Enabled for Windows XP and Linux (OS optimized for Hyper-Threading Technology) and Disabled for other OS (OS not optimized for Hyper-Threading Technology). When Disabled only one thread per enabled core is enabled.
Active Processor Cores	<b>All</b> 1	Number of cores to enable in each processor package.
Limit CPUID Maximum	Disabled <b>Enabled</b>	Disabled for Windows XP
Execute Disable Bit	Disabled <b>Enabled</b>	XD can prevent certain classes of malicious buffer overflow attacks when combined with supporting OS (Windows Server 2003 SP1, Windows XP SP2, SuSE Linux 9.2, RedHat Enterprise 3 Update 3.)
Intel Virtualization Technology	<b>Disabled</b> Enabled	When enabled, a VMM can utilize the additional hardware capabilities provided by Vanderpool Technology.

Note1: Not present when using Intel Celeron B810.

**Notes:**

Intel HT Technology (Hyper Threading Technology) is a performance feature which allows one core on the processor to appear like 2 cores to the operating system. This doubles the execution resources available to the O/S, which potentially increases the performance of your overall system.

Intel VT-x Technology (Virtualization Technology) Previously codenamed "Vanderpool", VT-x represents Intel's technology for virtualization on the x86 platform. In order to support "Virtualization Technology" the CPU must support VT-x and the BIOS setting "Intel Virtualization Technology" must be enabled.

Intel SMX Technology (Safer Mode Extensions Technology) is a part of the Trusted Execution Technology.

## 10.2.5 Advanced - SATA Configuration

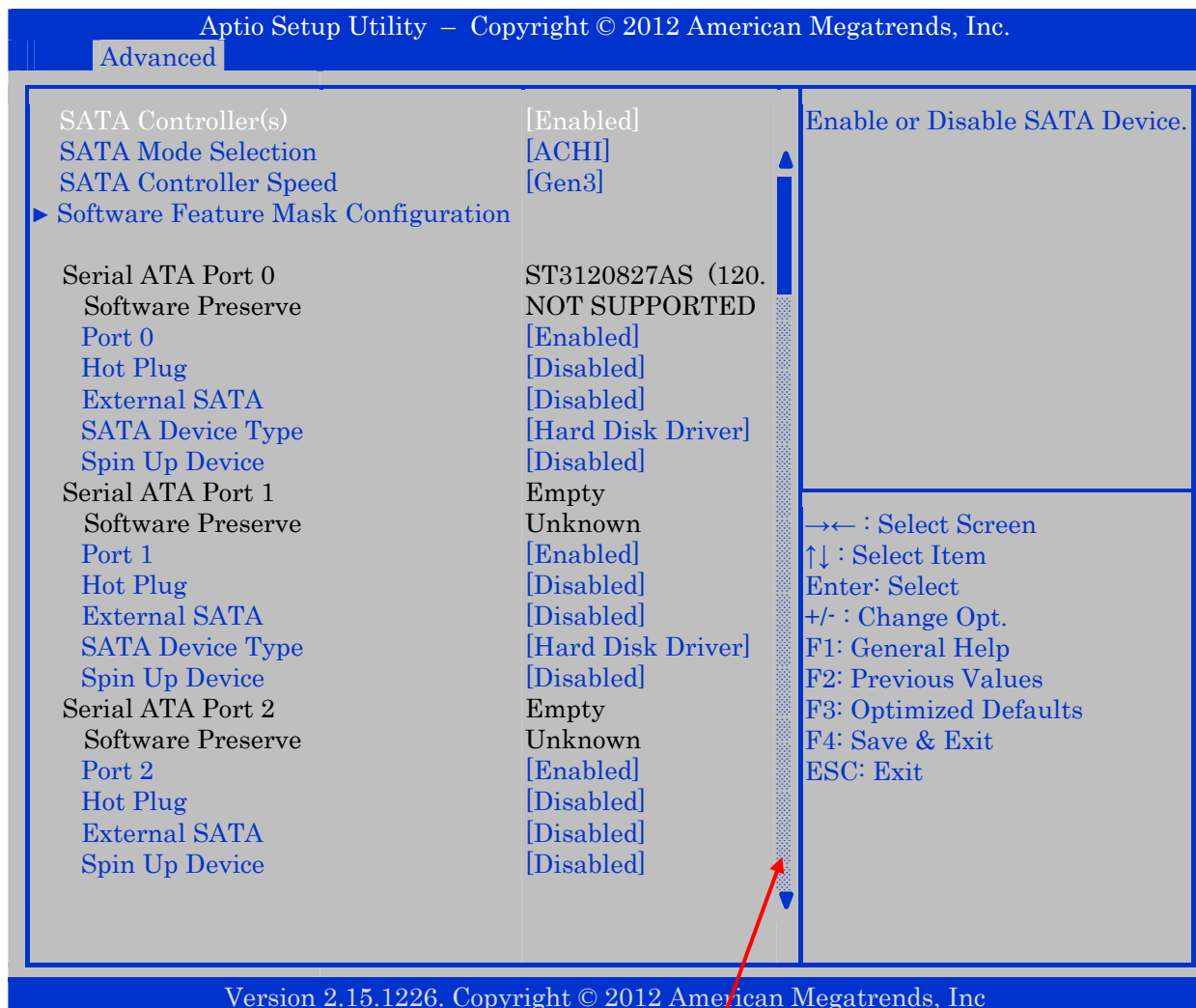

(Scroll indicator bar)

Note: By scrolling down (or up) also settings for Serial ATA Port 3 - 5 can be accessed.

Function	Selection	Description
SATA Controller(s)	Disabled <b>Enabled</b>	Enable or Disable SATA Device.
SATA Mode Selection	IDE <b>ACHI</b> RAID	Determines how SATA controller(s) operate. RAID is supported by the KTQM77/mITX only.
SATA Controller Speed	Gen1 Gen2 <b>Gen3</b>	Indicates the maximum speed the SATA controller can support.

Note: in the above BIOS menu the functions below the submenu *Software Feature Mask Configuration* will be described after the submenu description.

### 10.2.5.1 Software Feature Mask Configuration

Aptio Setup Utility – Copyright © 2012 American Megatrends, Inc.

Advanced

RAID0	[Enabled]	Enables or Disables RAID0 feature.
RAID1	[Enabled]	
RAID10	[Enabled]	
RAID5	[Enabled]	
Intel Rapid Recovery Technology	[Enabled]	
OROM UI and BANNER	[Enabled]	
HDD Unlock	[Enabled]	
LED Locate	[Enabled]	
IRRT Only on eSATA	[Enabled]	
Smart Response Technology	[Enabled]	
OROM UI Delay	[2 Seconds]	
		→← : Select Screen ↑↓ : Select Item Enter: Select +/- : Change Opt. F1: General Help F2: Previous Values F3: Optimized Defaults F4: Save & Exit ESC: Exit

Version 2.15.1226. Copyright © 2012 American Megatrends, Inc

Submenu *Software Feature Mask Configuration* description:

Function	Selection	Description
RAID0	Disabled <b>Enabled</b>	Enable or disable RAID0 feature.
RAID1	Disabled <b>Enabled</b>	Enable or disable RAID1 feature.
RAID10	Disabled <b>Enabled</b>	Enable or disable RAID10 feature.
RAID5	Disabled <b>Enabled</b>	Enable or disable RAID5 feature.
Intel Rapid Recovery Technology	Disabled <b>Enabled</b>	Enable or disable Intel Rapid Recovery Technology.
OROM UI and BANNER	Disabled <b>Enabled</b>	If enabled, then the OROM UI is shown. Otherwise, no OROM banner or information will be displayed if all disks and RAID volumes are Normal.
HDD Unlock	Disabled <b>Enabled</b>	If enabled, indicates that the HDD password unlock in the OS is enabled.
LED Locate	Disabled <b>Enabled</b>	If enabled, indicates that the LED/SGPIO hardware is attached and ping to locate feature is enabled on the OS.
IRRT Only on eSATA	Disabled <b>Enabled</b>	If enabled, then only IRRT volumes can span internal and eSATA drives. If disabled, then any RAID volume can span internal and eSATA drives.
Smart Response Technology	Disabled <b>Enabled</b>	Enable or disable Smart Response Technology
OROM UI Delay	<b>2 Seconds</b> 4 Seconds 6 Seconds 8 Seconds	If enabled, indicates the delay of the OROM UI Splash Screen in normal status.

Remaining *SATA Configuration* menu description:

Function	Selection	Description
Port 0	Disabled <b>Enabled</b>	Enable or Disable SATA Port.
Hot Plug	<b>Disabled</b> Enabled	Designates this port as Hot Pluggable.
External SATA	<b>Disabled</b> Enabled	External SATA Support.
SATA Device Type	<b>Hard Disk Drive</b> Solid State Drive	Identify the SATA port is connected to Solid State Drive or Hard Disk Drive.
Spin Up Device	<b>Disabled</b> Enabled	On an edge detect from 0 to 1, the PCH starts a COMRESET initialization sequence to the device.
Port 1	Disabled <b>Enabled</b>	Enable or Disable SATA Port.
Hot Plug	(see same function above)	(see same function above)
External SATA	(see same function above)	(see same function above)
SATA Device Type	(see same function above)	(see same function above)
Spin Up Device	(see same function above)	(see same function above)
Port 2	Disabled <b>Enabled</b>	Enable or Disable SATA Port.
Hot Plug	(see same function above)	(see same function above)
External SATA	(see same function above)	(see same function above)
Spin Up Device	(see same function above)	(see same function above)
Port 3	Disabled <b>Enabled</b>	Enable or Disable SATA Port.
Hot Plug	(see same function above)	(see same function above)
External SATA	(see same function above)	(see same function above)
Spin Up Device	(see same function above)	(see same function above)
Port4	Disabled <b>Enabled</b>	Enable or Disable SATA Port.
Hot Plug	(see same function above)	(see same function above)
External SATA	(see same function above)	(see same function above)
Spin Up Device	(see same function above)	(see same function above)
Port5	Disabled <b>Enabled</b>	Enable or Disable SATA Port.
Hot Plug	(see same function above)	(see same function above)
External SATA	(see same function above)	(see same function above)
Spin Up Device	(see same function above)	(see same function above)



## 10.2.6 Advanced - Intel TXT (LT) Configuration

*Intel TXT (LT) Configuration* is only present when using KTQM77/mITX.

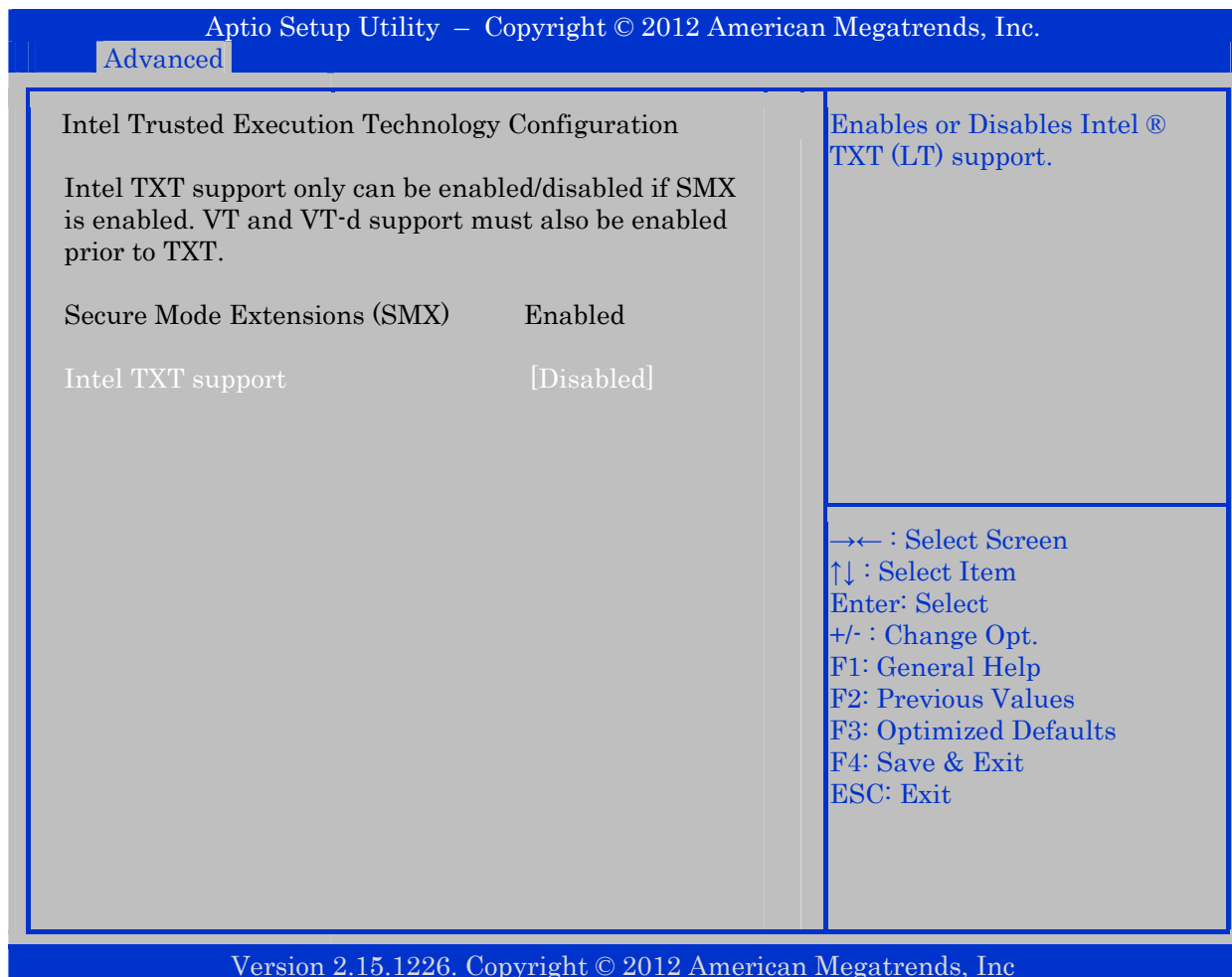

SMX (Intel Secure Mode Extension) instructions are enabled if supported by the CPU, so no BIOS settings are present.

VT (Intel Virtualization Technology) is enabled/disabled in the menu: *Advanced > CPU Configuration*.

VT-d can be enabled/disabled in the menu: *Chipset > System Agent (SA) Configuration*.

Function	Selection	Description
Intel TXT support	<b>Disabled</b> Enabled	Enables or Disables Intel ® TXT (LT) support.

## 10.2.7 Advanced - AMT Configuration

AMT Configuration is only present when using KTQM77/mITX.

Aptio Setup Utility – Copyright © 2012 American Megatrends, Inc.

Advanced

Intel AMT	[Disabled]	Enable/Disable Intel ® Active Management Technology BIOS Extension. Note: iAMT H/W is always enabled. This option just controls the BIOS Extension execution. If enabled, this requires additional firmware in the SPI device.
BIOS Hotkey Pressed	[Disabled]	
MEBx Selection Screen	[Disabled]	
Hide Un-Configure ME Confirmation	[Disabled]	
MEBx Debug Message Output	[Disabled]	
Un-Configure ME	[Disabled]	
AMT Wait Timer	0	
Disable ME	[Disabled]	
ASF	[Enabled]	
Active Remote Assistance Process	[Disabled]	
USB Configure	[Enabled]	
PET Progress	[Enabled]	
AMT CIRA Timeout	0	
Watchdog	[Disabled]	
OS Timer	0	
BIOS Timer	0	

→← : Select Screen  
 ↑↓ : Select Item  
 Enter: Select  
 +/- : Change Opt.  
 F1: General Help  
 F2: Previous Values  
 F3: Optimized Defaults  
 F4: Save & Exit  
 ESC: Exit

Version 2.15.1226. Copyright © 2012 American Megatrends, Inc

Function	Selection	Description
Intel AMT	<b>Disabled</b> Enabled	Enable/Disable Intel ® Active Management Technology BIOS Extension. Note: iAMT H/W is always enabled. This option just controls the BIOS Extension execution. If enabled, this requires additional firmware in the SPI device.
BIOS Hotkey Pressed (Note1)	<b>Disabled</b> Enabled	OEMFlag Bit 1: Enable/Disabled BIOS hotkey press.
MEBx Selection Screen (Note1)	<b>Disabled</b> Enabled	OEMFlag Bit 2: Enable/Disabled BIOS MEBx Selection Screen.
Hide Un-Configure ME Confirmation (Note1)	<b>Disabled</b> Enabled	OEMFlag Bit 6: Hide Un-Configure ME without password Confirmation Prompt
MEBx Debug Message Output (Note1)	<b>Disabled</b> Enabled	OEMFlag Bit 14: Enable MEBx Debug Message Output.
Un-Configure ME (Note1)	<b>Disabled</b> Enabled	OEMFlag Bit 15: Un-Configure ME without password.

Function	Selection	Description
AMT Wait Timer (Note1)	0 - 65535 (Note4)	Set timer to wait before sending ASF_GET_BOOT_OPTIONS.
Disable ME (Note1)	<b>Disabled</b> Enabled	Set ME to Soft Temporary Disabled.
ASF (Note1)	Disabled <b>Enabled</b>	Enable/Disabled Alert Specification Format.
Active Remote Assistance Process (Note1)	<b>Disabled</b> Enabled	Trigger CIRA boot.
USB Configure (Note1)	Disabled <b>Enabled</b>	Enable/Disable USB Configure function.
PET Progress (Note1)	Disabled <b>Enabled</b>	Users can Enable/Disable PET Events progress to receive PET events or not.
AMT CIRA Timeout (Note1) (Note5)	0 – 255 (Note4)	OEM defined timeout for MPS connection to be established. 0 – use the default timeout value of 60 seconds. 255 – MEBX waits until the connection succeeds.
Watchdog (Note2)	<b>Disabled</b> Enabled	Enable/Disable Watchdog Timer.
OS Timer (Note3)	0 - 65535 (Note4)	Set OS watchdog timer.
BIOS Timer (Note3)	0 - 65535 (Note4)	Set BIOS Watchdog Timer.

Note1: Only if Intel AMT = Enabled.

Note2: This Watchdog function is unsupported.

Recommendation, use Watchdog function present in *Hardware Health Configuration* menu.

Note3: Only if Watchdog = Enabled.

Note4: To enter number use digit keys and/or +/- keys.

Note5: Only if Active Remote Assistance Process = Enabled.

## 10.2.8 Advanced - Acoustic Management Configuration

Aptio Setup Utility – Copyright © 2012 American Megatrends, Inc.

Advanced

Acoustic Management Configuration		Option to Enable or Disable Automatic Acoustic Management
Automatic Acoustic Management	[Disabled]	
Sata Port 0 ST3120827AS Acoustic Mode	[Not Available]	
		→← : Select Screen ↑↓ : Select Item Enter: Select +/- : Change Opt. F1: General Help F2: Previous Values F3: Optimized Defaults F4: Save & Exit ESC: Exit

Version 2.15.1226. Copyright © 2012 American Megatrends, Inc

Function	Selection	Description
Automatic Acoustic Management	Enabled <b>Disabled</b>	Option to Enable or Disable Automatic Acoustic Management.

### Note:

Automatic acoustic management (AAM) is a method for reducing acoustic emanations in AT Attachment (ATA) mass storage devices, such as ATA hard disk drives and ATAPI optical disc drives. AAM is an optional feature set for ATA/ATAPI devices; when a device supports AAM, the acoustic management parameters are adjustable through a software or firmware user interface.

The ATA/ATAPI sub-command for setting the level of AAM operation is an 8-bit value from 0 to 255. Most modern drives ship with the vendor-defined value of 0x00 in the acoustic management setting. This often translates to the max-performance value of 254 stated in the standard. Values between 128 and 254 (0x80 - 0xFE) enable the feature and select most-quiet to most-performance settings along that range. Though hard drive manufacturers may support the whole range of values, the settings are allowed to be banded so many values could provide the same acoustic performance.

## 10.2.9 Advanced - USB Configuration

Aptio Setup Utility – Copyright © 2012 American Megatrends, Inc.

Advanced

USB Configuration		Enables Legacy USB support. AUTO option disables legacy support if no USB devices are connected. DISABLE option will keep USB devices available only for EFI applications.
USB Module Version	8.10.28	
USB Devices:	2 Hubs	
Legacy USB Support	[Enabled]	
USB3.0 Support	[Disabled]	
XHCI Hand-off	[Enabled]	
EHCI Hand-off	[Disabled]	
USB Mass Storage Driver Support	[Enabled]	
USB hardware delays and time-outs:		→← : Select Screen ↑↓ : Select Item Enter: Select +/- : Change Opt. F1: General Help F2: Previous Values F3: Optimized Defaults F4: Save & Exit ESC: Exit
USB transfer time-out	[20 sec]	
Device reset time-out	[20 sec]	
Device power-up delay	[Auto]	

Version 2.15.1226. Copyright © 2012 American Megatrends, Inc

Function	Selection	Description
Legacy USB Support	<b>Enabled</b> Disabled Auto	Enables Legacy USB support. AUTO option disables legacy support if no USB devices are connected. DISABLE option will keep USB devices available only for EFI applications.
USB3.0 Support	Enabled <b>Disabled</b>	Enable/Disable USB3.0 (XHCI) Controller support.
XHCI Hand-off	<b>Enabled</b> Disabled	This is a workaround for OSES without XHCI hand-off support. The XHCI ownership change should be claimed by XHCI driver.
EHCI Hand-off	Enabled <b>Disabled</b>	This is a workaround for OSES without EHCI hand-off support. The EHCI ownership change should be claimed by EHCI driver.
USB Mass Storage Driver Support	<b>Enabled</b> Disabled	Enable/disable USB Mass Storage Driver Support.
USB transfer time-out	1 sec 5 sec 10 sec <b>20 sec</b>	The time-out value for Control, Bulk, and Interrupt transfers.
Device reset time-out	10 sec <b>20 sec</b> 30 sec 40 sec	USB mass storage device Start Unit command time-out.
Device power-up delay	<b>Auto</b> Normal	Maximum time the device will take before it properly reports itself to the Host Controller. 'Auto' uses default value: for a Root port it is 100 ms, for a Hub port the delay is taken from Hub descriptor.

## 10.2.10 Advanced - SMART Settings

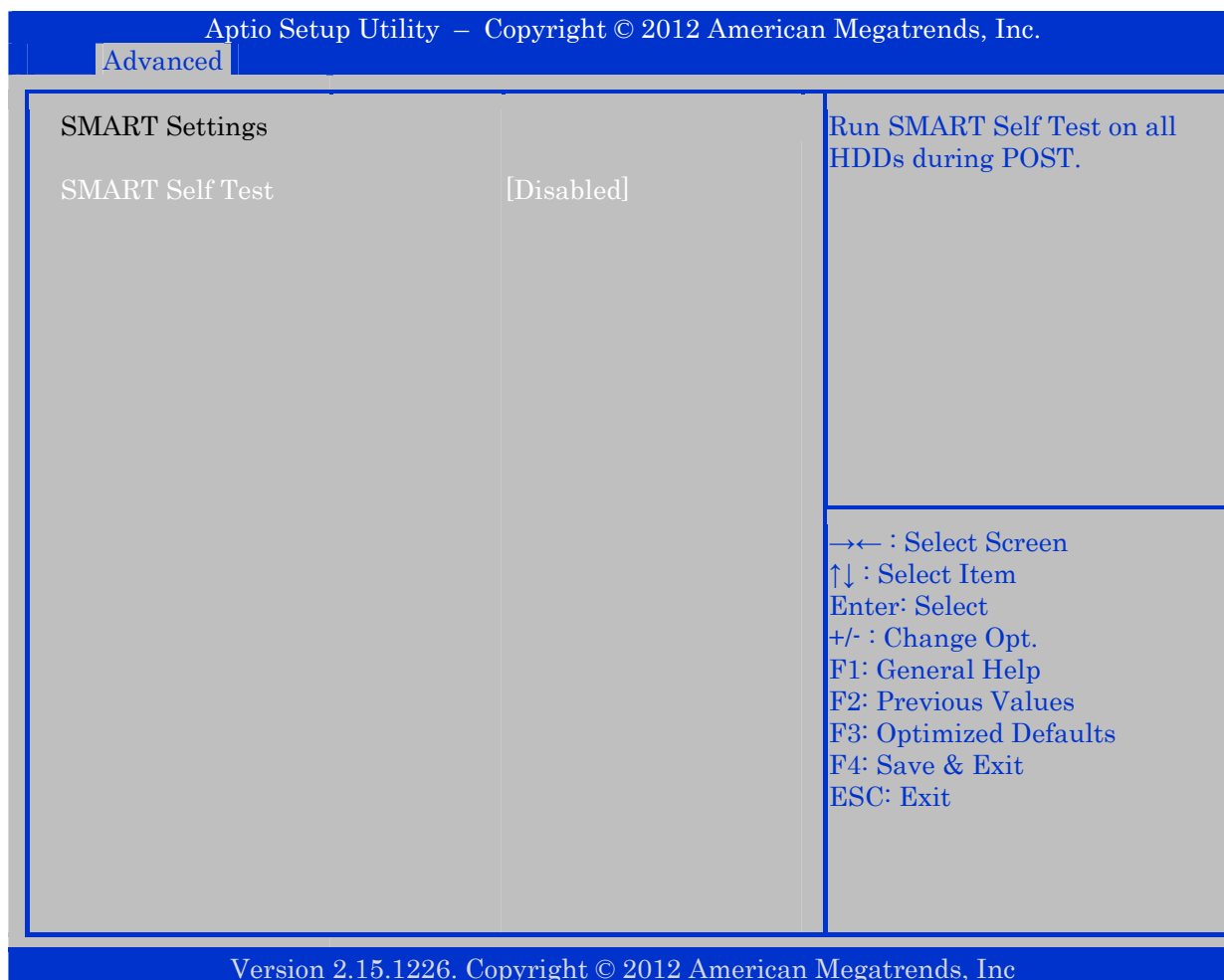

Function	Selection	Description
SMART Self Test	<b>Disabled</b> Enabled	Run SMART Self-Test on all HDDs during POST.

## Note:

S.M.A.R.T. (Self-Monitoring, Analysis and Reporting Technology; often written as SMART) is a monitoring system for computer hard disk drives to detect and report on various indicators of reliability, in the hope of anticipating failures.

## 10.2.11 Advanced - Super IO Configuration

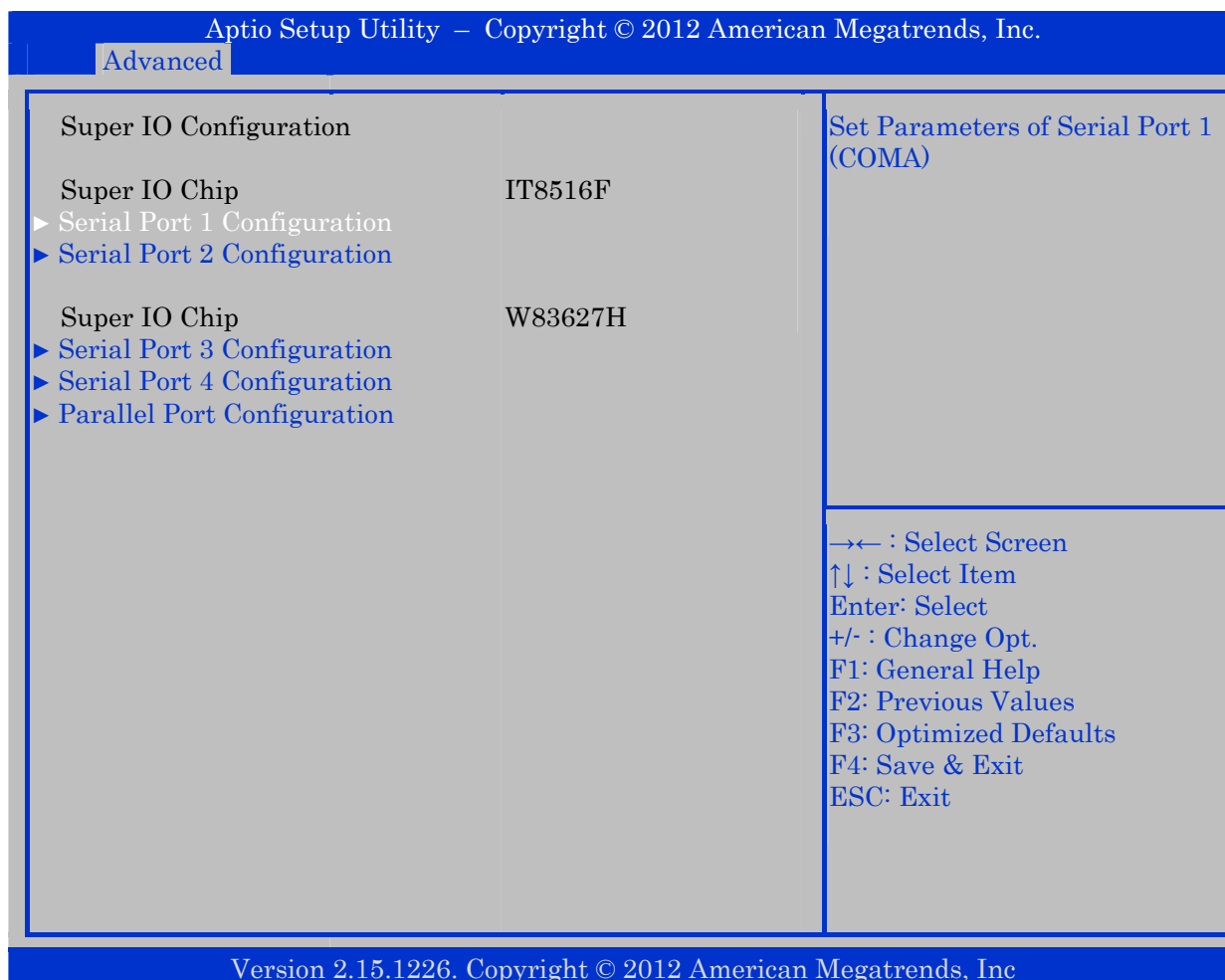

Note: Parallel Port is not available (connector not mounted).

The 5 submenus are shown and described on the following pages.



## 10.2.11.1 Serial Port 1 Configuration

Aptio Setup Utility – Copyright © 2012 American Megatrends, Inc.

Advanced

Serial Port 1 Configuration		Enable or Disable Serial Port (COM)
Serial Port Device Settings	[Enabled] IO=3F8h; IRQ=4;	
Change Settings	[Auto]	→← : Select Screen ↑↓ : Select Item Enter: Select +/- : Change Opt. F1: General Help F2: Previous Values F3: Optimized Defaults F4: Save & Exit ESC: Exit

Version 2.15.1226. Copyright © 2012 American Megatrends, Inc

Function	Selection	Description
Serial Port	Disabled <b>Enabled</b>	Enable or Disable Serial Port (COM)
Change Settings (Note1)	<b>Auto</b> IO=3F8h; IRQ=4; IO=3F8h; IRQ=3,4,5,6,7,10,11,12; IO=2F8h; IRQ=3,4,5,6,7,10,11,12; IO=3E8h; IRQ=3,4,5,6,7,10,11,12; IO=2E8h; IRQ=3,4,5,6,7,10,11,12;	Select an optimal setting for Super IO device.

Note1: only if Serial Port = Enabled

## 10.2.11.2 Serial Port 2 Configuration

Aptio Setup Utility – Copyright © 2012 American Megatrends, Inc.

Advanced

<p>Serial Port 2 Configuration</p> <p>Serial Port Device Settings [Enabled] IO=2F8h; IRQ=3;</p> <p>Change Settings [Auto]</p>	<p>Enable or Disable Serial Port (COM)</p> <p>→← : Select Screen ↑↓ : Select Item Enter: Select +/- : Change Opt. F1: General Help F2: Previous Values F3: Optimized Defaults F4: Save &amp; Exit ESC: Exit</p>
---	---

Version 2.15.1226. Copyright © 2012 American Megatrends, Inc

Function	Selection	Description
Serial Port	Disabled <b>Enabled</b>	Enable or Disable Serial Port (COM)
Change Settings (Note1)	<b>Auto</b> IO=2F8h; IRQ=3; IO=3F8h; IRQ=3,4,5,6,7,10,11,12; IO=2F8h; IRQ=3,4,5,6,7,10,11,12; IO=3E8h; IRQ=3,4,5,6,7,10,11,12; IO=2E8h; IRQ=3,4,5,6,7,10,11,12;	Select an optimal setting for Super IO device.

Note1: only if Serial Port = Enabled

## 10.2.11.3 Serial Port 3 Configuration

Aptio Setup Utility – Copyright © 2012 American Megatrends, Inc.

Advanced

Serial Port 3 Configuration		Enable or Disable Serial Port (COM)
Serial Port Device Settings	[Enabled] IO=3E8h; IRQ=7;	
Change Settings Device Mode	[Auto] [Standard Serial Po...]	
		→← : Select Screen ↑↓ : Select Item Enter: Select +/- : Change Opt. F1: General Help F2: Previous Values F3: Optimized Defaults F4: Save & Exit ESC: Exit

Version 2.15.1226. Copyright © 2012 American Megatrends, Inc

Function	Selection	Description
Serial Port	Disabled <b>Enabled</b>	Enable or Disable Serial Port (COM)
Change Settings (Note1)	<b>Auto</b> IO=3E8h; IRQ=7; IO=3F8h; IRQ=3,4,5,6,7,10,11,12; IO=2F8h; IRQ=3,4,5,6,7,10,11,12; IO=3E8h; IRQ=3,4,5,6,7,10,11,12; IO=2E8h; IRQ=3,4,5,6,7,10,11,12;	Select an optimal setting for Super IO device.
Device Mode (Note1)	<b>Standard Serial Port Mode</b> IrDA 1.0 (HP SIR) Mode ASKIR Mode	Change the Serial Port mode. Select <High Speed> or <Normal mode> mode.

Note1: only if Serial Port = Enabled

## 10.2.11.4 Serial Port 4 Configuration

Aptio Setup Utility – Copyright © 2012 American Megatrends, Inc.

Advanced

Serial Port 4 Configuration		Enable or Disable Serial Port (COM)
Serial Port Device Settings	[Enabled] IO=2E8h; IRQ=10;	
Change Settings Device Mode	[Auto] [Standard Serial Po...]	
		→← : Select Screen ↑↓ : Select Item Enter: Select +/- : Change Opt. F1: General Help F2: Previous Values F3: Optimized Defaults F4: Save & Exit ESC: Exit

Version 2.15.1226. Copyright © 2012 American Megatrends, Inc

Function	Selection	Description
Serial Port	Disabled <b>Enabled</b>	Enable or Disable Serial Port (COM)
Change Settings (Note1)	<b>Auto</b> IO=2E8h; IRQ=10; IO=3F8h; IRQ=3,4,5,6,7,10,11,12; IO=2F8h; IRQ=3,4,5,6,7,10,11,12; IO=3E8h; IRQ=3,4,5,6,7,10,11,12; IO=2E8h; IRQ=3,4,5,6,7,10,11,12;	Select an optimal setting for Super IO device.
Device Mode (Note1)	<b>Standard Serial Port Mode</b> IrDA 1.0 (HP SIR) Mode ASKIR Mode	Change the Serial Port mode. Select <High Speed> or <Normal mode> mode.

Note1: only if Serial Port = Enabled

### 10.2.11.5 Parallel Port Configuration

Note: Parallel Port is not available (connector not mounted).

Aptio Setup Utility – Copyright © 2012 American Megatrends, Inc.

Advanced

Parallel Port Configuration		Enable or Disable Parallel Port (LPT/LPTE)
Parallel Port Device Settings	[Enabled] IO=378h; IRQ=5;	
Change Settings Device Mode	[Auto] [Standard Parallel ...]	
		→← : Select Screen ↑↓ : Select Item Enter: Select +/- : Change Opt. F1: General Help F2: Previous Values F3: Optimized Defaults F4: Save & Exit ESC: Exit

Version 2.15.1226. Copyright © 2012 American Megatrends, Inc

Function	Selection	Description
Parallel Port	Disabled <b>Enabled</b>	Enable or Disable Parallel Port (LPT/LPTE)
Change Settings (Note1)	<b>Auto</b> IO=378h; IRQ=5; IO=378h; IRQ=7,10,11,12; IO=278h; IRQ=5,6,7,10,11,12; IO=3BCh; IRQ=5,6,7,10,11,12; IO=378h; IO=278h; IO=3BCh;	Select an optimal setting for Super IO device.
Device Mode (Note1)	<b>Standard Parallel Port Mode</b> EPP Mode ECP Mode EPP Mode & ECP Mode	Change the Printer Port mode.

Note1: only if Parallel Port = Enabled.

## 10.2.12 Advanced - Voltage Monitor

Aptio Setup Utility – Copyright © 2012 American Megatrends, Inc.

Advanced

Voltage Monitor	
VCore	: 0.968 V
1.05	: 1.064 V
1.5	: 1.512 V
3.3	: 3.392 V
3.3SB	: 3.392 V
5	: 5.188 V
12	: 12.144 V
VBAT	: 3.150 V

→← : Select Screen  
↑↓ : Select Item  
Enter: Select  
+/- : Change Opt.  
F1: General Help  
F2: Previous Values  
F3: Optimized Defaults  
F4: Save & Exit  
ESC: Exit

Version 2.15.1226. Copyright © 2012 American Megatrends, Inc

## 10.2.13 Advanced - Hardware Health Configuration

Aptio Setup Utility – Copyright © 2012 American Megatrends, Inc.		
Advanced		
Hardware Health Configuration		Disabled = Full speed.
System Temperature	: 30°C/86°F	Thermal: does regulate fan speed according to specified temperature.
System Temperature Ext	: 24°C/75°F	
CPU Temperature	: 49.10°C/120°F	
System Fan Speed	: 1543 RPM	Speed: does regulate according to specified RPM.
System Temperature Ext Type	[ OneWire @ GPIO16]	
Fan Cruise Control	[Thermal]	
Fan Settings	35	
Fan Min limit	0	
Fan Max limit	100	
CPU Fan Speed	: 1374 RPM	
Fan Cruise Control	[Thermal]	
Fan Settings	50	
Fan Min limit	0	
Fan Max limit	100	
Watchdog Function	0	

Version 2.15.1226. Copyright © 2012 American Megatrends, Inc

Function	Selection	Description
System Temperature Ext Type (note1)	<b>Disabled</b> LM75 @ 0x90 OneWire @ GPIO16	
Fan Cruise Control (System Fan)	<b>Disabled</b> Thermal (note2) Speed	Disabled = Full speed. Thermal: Regulate according to specified °C. Speed: Regulate according to specified RPM.
Fan Settings (System Fan)	30 – 90 (note2,note3) 1000 – 9999 (note4)	
Fan Min limit (System Fan) (note5)	<b>0</b> (note6)	Minimum PWM %, can be used to make sure fan is always active. Make sure Min limit < Max limit.
Fan Max limit (System Fan) (note5)	<b>100</b> (note6)	Maximum PWM %, can be used to limit the fan noise. Make sure Min limit < Max limit.
Fan Cruise Control (CPU Fan)	<b>Disabled</b> Thermal Speed	Disabled = Full speed. Thermal: Regulate according to specified °C. Speed: Regulate according to specified RPM.
Fan Settings (CPU Fan)	30 – 90 (note3) 1000 – 9999 (note4)	
Fan Min limit (CPU Fan) (note7)	<b>0</b> (note6)	Minimum PWM %, can be used to make sure fan is always active. Make sure Min limit < Max limit.
Fan Max limit (CPU Fan) (note7)	<b>100</b> (note6)	Maximum PWM %, can be used to limit the fan noise. Make sure Min limit < Max limit.
Watchdog Function	0 - 255 (note8)	0 = Disabled. Enter the service interval in seconds before system will reset. Refer to manual how to reload the timer.

Note1: Only visible if external temperature sensor like PN1053-4925 “Cable Temperature Sensor - 44P, 400 mm” is connected.

Note2: Only visible if external temperature sensor is connected and if System Temperature Ext Type is not Disabled.

Note3: °C (if Fan Cruise Control = Thermal) use either digit keys to enter value or +/- keys to increase/decrease value. Don't use mix of digit keys and +/- keys.

Note4: RPM (if Fan Cruise Control = Speed) use either digit keys to enter value or +/- keys to increase/decrease value by 100. Don't use mix of digit keys and +/- keys.

Note5: Only visible if external temperature sensor is connected and if System Fan Cruise Control is Thermal.

Note6: Use number keys to enter value.

Note7: Only visible if CPU Fan Cruise Control is Thermal.

Note8: Seconds, use digit keys to enter value. Value 0 means Watchdog is disabled. Refer to “KT-API-V2 User Manual” to control the Watchdog via API or refer to “KT-API-V2 User Manual DLL” how to control Watchdog via Windows DLL.



## 10.2.14 Advanced - Displayblock Setup

Aptio Setup Utility – Copyright © 2012 American Megatrends, Inc.

Advanced

Displayblock Setup		
LCDVCC Voltage	[3V3]	
Backlight Signal Inversion	[Disabled]	
		→← : Select Screen ↑↓ : Select Item Enter: Select +/- : Change Opt. F1: General Help F2: Previous Values F3: Optimized Defaults F4: Save & Exit ESC: Exit

Version 2.15.1226. Copyright © 2012 American Megatrends, Inc

Function	Selection	Description
LCDVCC Voltage	<b>3V3</b> 5V	Set the LVDS Display Panel voltage to either 3.3V or 5V.
Backlight Signal Inversion	<b>Disabled</b> Enabled	Select Disabled if BKLTEN# signal (available in the LVDS connector), shall behave normally: active low to enable backlight. Select Enabled if BKLTEN# signal shall behave inverted: active high to enable backlight.

## 10.2.15 Advanced - LAN Configuration

Aptio Setup Utility – Copyright © 2012 American Megatrends, Inc.

Advanced

<p>LAN Configuration System UUID {f4af2da3-b59d-58a9-466cb11a02b0486f}</p> <p>ETH1 Configuration (Left) [Enabled] Wake on LAN [Enabled] MAC Address &amp; Link status: 00E0F4288EA3+ ETH2 Configuration (Upper) [Enabled] MAC Address &amp; Link status: 00E0F4288EA4- ETH3 Configuration (Lower) [Enabled] MAC Address &amp; Link status: 00E0F4288EA5-</p> <p>► Network Stack</p>	<p>Control of Ethernet Devices and PXE boot. To disable ETH1, ME Subsystem must be as well.</p>
	<p>→← : Select Screen ↑↓ : Select Item Enter: Select +/- : Change Opt. F1: General Help F2: Previous Values F3: Optimized Defaults F4: Save &amp; Exit ESC: Exit</p>

Version 2.15.1226. Copyright © 2012 American Megatrends, Inc

Note: *ETH2 Configuration (Upper)* and *ETH3 Configuration (Lower)* are only present if using KTQM77/mITX.

Function	Selection	Description
ETH1 Configuration (Left)	Disabled <b>Enabled</b> With PXE boot	Control of Ethernet Devices and PXE boot. To disable ETH1, ME Subsystem must be as well.
Wake on LAN	<b>Enabled</b> Disabled	Enable or disable integrated LAN to wake the system. (The Wake On LAN cannot be disabled if ME is on at Sx state.)
ETH2 Configuration (Upper)	Disabled <b>Enabled</b> With PXE boot	Control of Ethernet Devices and PXE boot. To disable ETH2, ME Subsystem must be as well.
ETH3 Configuration (Lower)	Disabled <b>Enabled</b> With PXE boot	Control of Ethernet Devices and PXE boot. To disable ETH3, ME Subsystem must be as well.

## 10.2.15.1 Network Stack

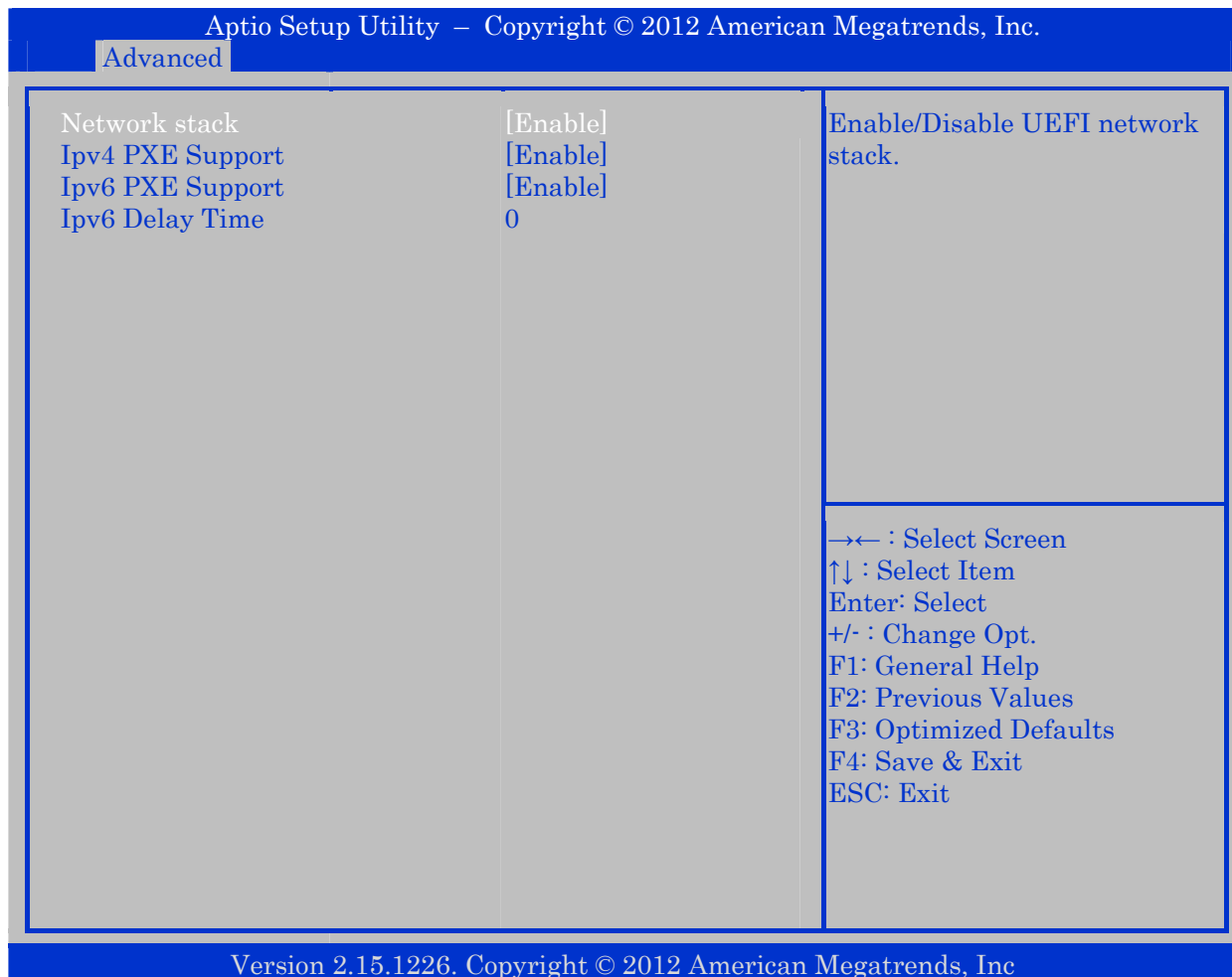

Function	Selection	Description
Network stack	<b>Disable Link</b> Enabled	Enable/Disable UEFI network stack.
Ipv4 PXE Support (Note1)	<b>Enabled</b> Disabled	Enable Ipv4 PXE Boot Support. If disabled IPV4 PXE boot option will not be created.
Ipv6 PXE Support (Note1)	<b>Enabled</b> Disabled	Enable Ipv6 PXE Boot Support. If disabled IPV6 PXE boot option will not be created.
IPv6 Delay Time (Note1)	<b>0 – 15</b> (Note2)	Set Seconds of Delay Before IPv6 PXE Boot. Default 0 Seconds.

Note1: Only if Network stack = Enabled.

Note2: To enter number use digit keys and/or +/- keys.

## 10.2.16 Advanced - Delay Startup

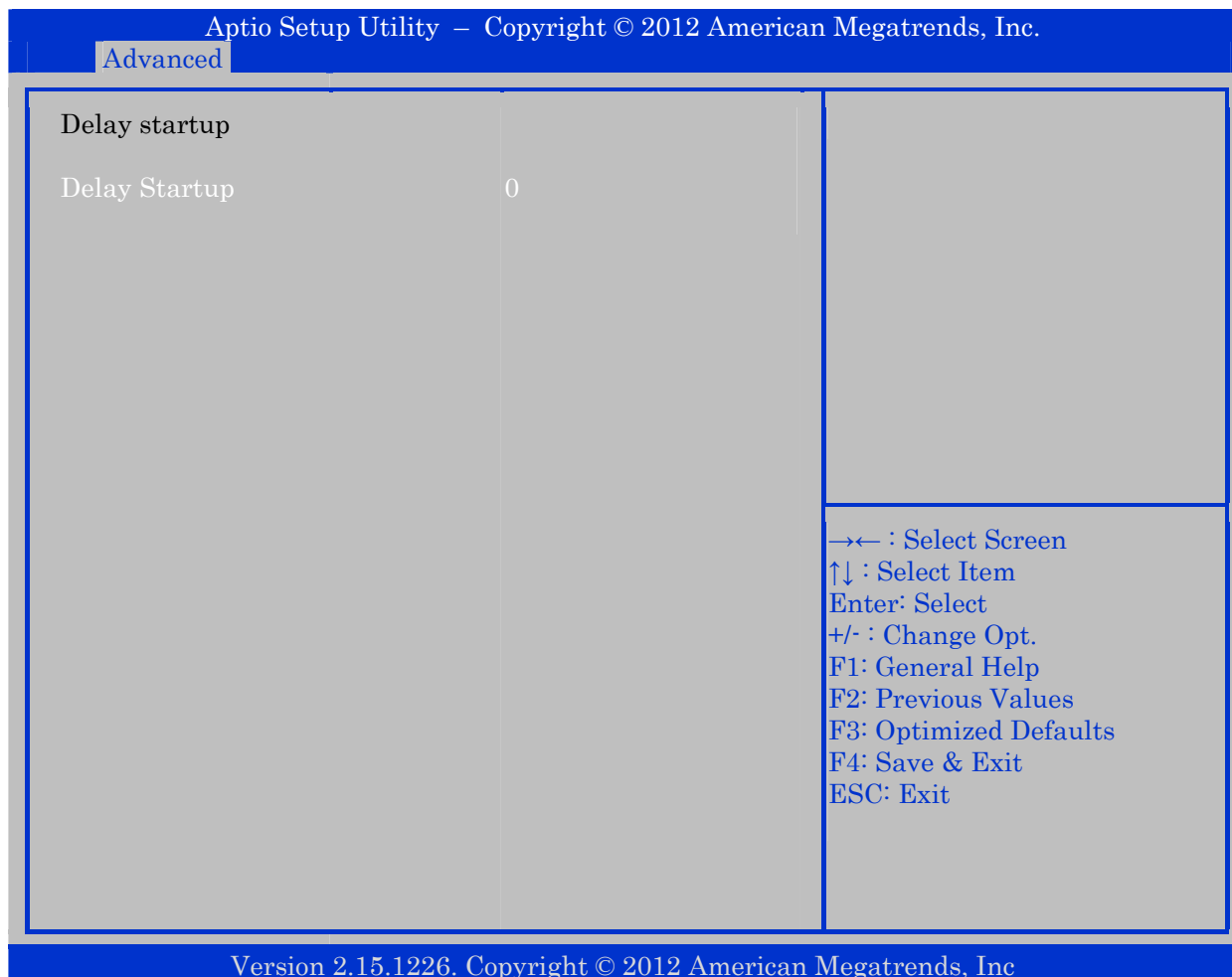

Function	Selection	Description
Delay Startup	0 – 9999 Note1)	Delay startup value is in ms.

Note1: To enter number use digit keys and/or +/- keys.

The delay initiates if the value is different from 0, starts at the earliest possible point of the BIOS boot. For some add-on devices the BIOS boot is too fast for proper detection. In other words, the setting is meant as a possible fix to Add-on device detection problems.

## 10.2.17 Advanced - Serial Port Console Redirection

Aptio Setup Utility – Copyright © 2012 American Megatrends, Inc.

Advanced

COM0 Console Redirection [Disabled] ▶ Console Redirection Settings		Console Redirection Enable or Disable.
COM1 Console Redirection [Disabled] ▶ Console Redirection Settings		
COM2 Console Redirection [Disabled] ▶ Console Redirection Settings		
COM3 Console Redirection [Disabled] ▶ Console Redirection Settings		→← : Select Screen ↑↓ : Select Item Enter: Select +/- : Change Opt. F1: General Help F2: Previous Values F3: Optimized Defaults F4: Save & Exit ESC: Exit
COM4(Pci Bus0,Dev0,Func0) (Disabled) Console Redirection Port Is Disabled		
Serial Port for Out-of-Band Management/ Windows Emergency Management Services (EMS) Console Redirection [Disabled] ▶ Console Redirection Settings		

Version 2.15.1226. Copyright © 2012 American Megatrends, Inc

### 10.2.17.1 Console Redirection Settings

The *Console Redirection Settings* menu are only available if related *Console Redirection* is Enabled. A different menu is available for Serial Port for Out-of-Band Management, see next page.

Aptio Setup Utility – Copyright © 2012 American Megatrends, Inc.		
Advanced		
COM0 Console Redirection Settings		Emulation: ANSI: Extended ASCII char set. VT100: ASCII char set. VT100+: Extends VT100 to support color, function keys, etc. VT-UTF8: Uses UTF8 encoding to map Unicode chars onto 1 or more bytes.
Terminal Type	[ANSI]	→← : Select Screen ↑↓ : Select Item Enter: Select +/- : Change Opt. F1: General Help F2: Previous Values F3: Optimized Defaults F4: Save & Exit ESC: Exit
Bits per second	[115200]	
Data Bits	[8]	
Parity	[None]	
Stop Bits	[1]	
Flow Control	[None]	
VT-UTF8 Combo Key Support	[Enabled]	
Recorder Mode	[Disabled]	
Resolution 100x31	[Disabled]	
Legacy OS Redirection Resolution	[80x24]	
Putty Keypad	[VT100]	
Redirection After BIOS POST	[Always Enable]	
Version 2.15.1226. Copyright © 2012 American Megatrends, Inc		

Function	Selection	Description
Terminal Type	VT100 VT100+ VT-UTF8 <b>ANSI</b>	Emulation: ANSI: Extended ASCII char set. VT100: ASCII char set. VT100+: Extends VT100 to support color, function keys, etc. VT-UTF8: Uses UTF8 encoding to map Unicode chars onto 1 or more bytes.
Bits per second	9600 19200 38400 57600 <b>115200</b>	Select serial port transmission speed. The speed must be matched on the other side. Long or noisy lines may require lower speeds.
Data Bits	<b>7, 8</b>	Data Bits
Parity	<b>None</b> Even Odd Mark Space	A parity bit can be sent with the data bits to detect some transmission errors. Even: parity bit is 0 if the num of 1's in the data bits is even. Odd: parity bit is 0 if the num of 1's in the data bits is odd. Mark: parity bit is always 1. Space: parity bit is always 0. Mark/Space do not allow error detection.
Stop Bits	<b>1</b> 2	Stop bits indicate the end of a serial data packet. (A start bit indicates the beginning). The standard setting is 1 stop bit. Communication with slow devices may require more than 1 stop bit.
Flow Control	<b>None</b> Hardware RTS/CTS	Flow control can prevent data loss from buffer overflow. When sending data, if the receiving buffers are full, a 'stop' signal can be sent to stop the data flow. Once the buffers are empty, a 'start' signal can be sent to re-start the flow. Hardware flow control uses two wires to send start/stop signals.
VT-UTF8 Combo Key Support	Disabled <b>Enabled</b>	Enable VT-UTF8 Combination Key Support for ANSI/VT100 terminals.
Recorder Mode	<b>Disabled</b> Enabled	On this mode enabled only text will be send. This is to capture Terminal data.
Resolution 100x31	<b>Disabled</b> Enabled	Enables or disables extended terminal resolution.
Legacy OS Redirection Resolution	<b>80x24</b> 80x25	On Legacy OS, the Number of Rows and Columns supported redirection.
Putty Keypad	<b>VT100</b> LINUX XTERMR6 SCO ESCN VT400	Select FunctionKey and KeyPad on Putty.
Redirection After BIOS POST	<b>Always Enable</b> BootLoader	The settings specify if BootLoader is selected than Legacy console redirection is disabled before booting to Legacy OS. Default value is Always Enable which means Legacy console Redirection is enabled for Legacy OS.

When *Serial Port for Out-of-Band Management/Windows Emergency Management Services (EMS) > Console Redirection* is enabled:

Aptio Setup Utility – Copyright © 2012 American Megatrends, Inc.

Advanced

Out-of-Band Mgmt Port	[COM0]	Microsoft Windows Emergency Management Services (EMS) allows for remote management of a Windows Server OS through a serial port.
Terminal Type	[VT-UTF8]	
Bits per second	[115200]	
Flow Control	[None]	
Data Bits	8	
Parity	None	
Stop Bits	1	
		→← : Select Screen ↑↓ : Select Item Enter: Select +/- : Change Opt. F1: General Help F2: Previous Values F3: Optimized Defaults F4: Save & Exit ESC: Exit

Version 2.15.1226. Copyright © 2012 American Megatrends, Inc

Function	Selection	Description
Out-of-Band Mgmt Port	<b>COM0</b> COM1 COM2 COM3 COM4 (Pci Bus0,Dev0, Func0) (Disabled)	Microsoft Windows Emergency Management Services (EMS) allows for remote management of a Windows Server OS through a serial port.
Terminal Type	VT100 VT100+ <b>VT-UTF8</b> ANSI	VT-UTF8 is the preferred terminal type for out-of-band management. The next best choice is VT100+ and then VT100. See above, in Console Redirection Settings page, for more Help with Terminal Type/Emulation.
Bits per second	9600 19200 57600 <b>115200</b>	Select serial port transmission speed. The speed must be matched on the other side. Long or noisy lines may require lower speeds.
Flow Control	<b>None</b> Hardware RTS/CTS Software Xon/Xoff	Flow control can prevent data loss from buffer overflow. When sending data, if the receiving buffers are full, a 'stop' signal can be sent to stop the data flow. Once the buffers are empty, a 'start' signal can be sent to re-start the flow. Hardware flow control uses two wires to send start/stop signals.



## 10.2.18 Advanced - CPU PPM Configuration

Aptio Setup Utility – Copyright © 2012 American Megatrends, Inc.

Advanced

CPU PPM Configuration		Enable/Disable Intel SpeedStep
EIST	[Enabled]	
Turbo Mode	[Enabled]	
CPU C3 Report	[Enabled]	
CPU C6 Report	[Enabled]	
CPU C7 Report	[Enabled]	
Config TDP LOCK	[Disabled]	
Long duration power limit	0	
Long duration maintained	0	
Short duration power limit	0	
ACPI T State	[Disabled]	

→← : Select Screen  
 ↑↓ : Select Item  
 Enter: Select  
 +/- : Change Opt.  
 F1: General Help  
 F2: Previous Values  
 F3: Optimized Defaults  
 F4: Save & Exit  
 ESC: Exit

Version 2.15.1226. Copyright © 2012 American Megatrends, Inc

Function	Selection	Description
EIST	Disabled <b>Enabled</b>	Enable/Disable Intel SpeedStep.
Turbo Mode (Note1)	Disabled <b>Enabled</b>	Turbo Mode
CPU C3 Report	Disabled <b>Enabled</b>	Enable/Disable CPU C3 (ACPI C2) report to OS
CPU C6 Report	Disabled <b>Enabled</b>	Enable/Disable CPU C6 (ACPI C3) report to OS
CPU C7 Report	Disabled <b>Enabled</b>	Enable/Disable CPU C7 (ACPI C3) report to OS
Config TDP LOCK	<b>Disabled</b> Enabled	Lock the Config TDP Control register.
Long duration power limit	<b>0 – 255</b> (Note2)	Long duration power limit in Watts, 0 means use factory default.
Long duration maintained	<b>0 – 120</b> (Note2)	Time window which the long duration power is maintained.
Short duration power limit	<b>0 – 255</b> (Note2)	Short duration power limit in Watts, 0 means use factory default.
ACPI T State	<b>Disabled</b> Enabled	Enable/Disable ACPI T State support.

Note1: Not present when using Intel Celeron B810 CPU or i3 Core CPU.

Note2: To enter number use digit keys.

## 10.3 Chipset

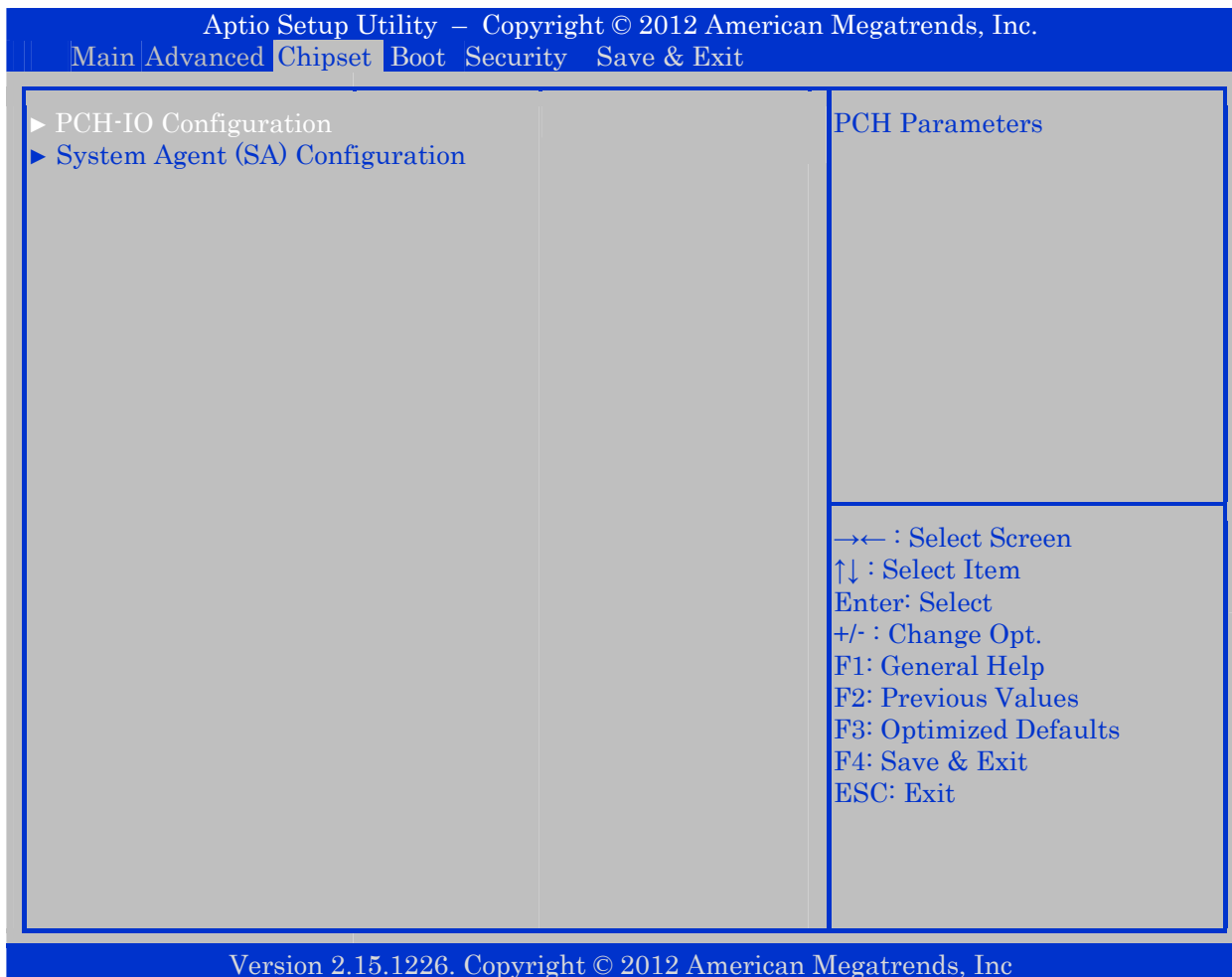

### 10.3.1 PCH-IO Configuration

Aptio Setup Utility – Copyright © 2012 American Megatrends, Inc.

Chipset

Intel PCH RC Version	1.5.0.0	PCI Express Configuration settings
Intel PCH SKU Name	QM77	
Intel PCH Rev ID	04/C1	
▶ PCI Express Configuration		
▶ USB Configuration		
▶ PCH Azalia Configuration		
Restore AC Power Loss	[Power On]	

→← : Select Screen  
 ↑↓ : Select Item  
 Enter: Select  
 +/- : Change Opt.  
 F1: General Help  
 F2: Previous Values  
 F3: Optimized Defaults  
 F4: Save & Exit  
 ESC: Exit

Version 2.15.1226. Copyright © 2012 American Megatrends, Inc

Note: *Intel PCH SKU Name* depends on the actual board type, QM77 or HM76.

Please find description of the *PCI Express Configuration*, *USB Configuration* and *PCH Azalia Configuration* on the following pages.

Function	Selection	Description
Restore AC Power Loss	Power Off <b>Power On</b> Last State	Select AC Power state when power is re-applied after a power failure.

## 10.3.1.1 PCI Express Configuration

Aptio Setup Utility – Copyright © 2012 American Megatrends, Inc.

Chipset

<b>PCI Express Configuration</b>		Enable or disable PCI Express Subtractive Decode.
Subtractive Decode Subtractive Decode Port#	[Disabled] 0	
<ul style="list-style-type: none"> <li>▶ PCI Express Root Port 1</li> <li>▶ PCI Express Root Port 2</li> <li>▶ PCI Express Root Port 3</li> <li>▶ PCI Express Root Port 4</li> <li>▶ PCI Express Root Port 6</li> <li>▶ PCI Express Root Port 7</li> <li>▶ PCI Express Root Port 8</li> </ul>		→← : Select Screen ↑↓ : Select Item Enter: Select +/- : Change Opt. F1: General Help F2: Previous Values F3: Optimized Defaults F4: Save & Exit ESC: Exit

Version 2.15.1226. Copyright © 2012 American Megatrends, Inc

Function	Selection	Description
Subtractive Decode	<b>Disabled</b> Enabled	Enable or disable PCI Express Subtractive Decode.
Subtractive Decode Port# (Note1)	<b>0</b> (Note2)	Select PCI Express Subtractive Decode Root Port. User to ensure port availability.

Note1: Only visible if *Subtractive Decode* is Enabled.

Note2: To enter number use digit keys and/or +/- keys.

## 10.3.1.1.1 PCI Express Root Port (1-4, 6-8)

Aptio Setup Utility – Copyright © 2012 American Megatrends, Inc.

Chipset

PCI Express Root Port (1-4, 6-8)	[Enabled]	Control the PCI Express Root Port.
ASPM Support	[Disabled]	
PME SCI	[Enabled]	
PCIe Speed	[Auto]	

→← : Select Screen  
↑↓ : Select Item  
Enter: Select  
+/- : Change Opt.  
F1: General Help  
F2: Previous Values  
F3: Optimized Defaults  
F4: Save & Exit  
ESC: Exit

Version 2.15.1226. Copyright © 2012 American Megatrends, Inc

Function	Selection	Description
PCI Express Root Port (1-4, 6-8) (Note 1)	Disabled <b>Enabled</b>	Control the PCI Express Root Port.
ASPM Support	<b>Disabled</b> L0s L1 L0sL1 Auto	Set the ASPM Level. Disabled: Disabled ASPM L0s: Force all links to L0s State Auto: BIOS auto configure
PME SCI	Disabled <b>Enabled</b>	Enable or disable PCI Express PME SCI.
PCIe Speed	<b>Auto</b> Gen1 Gen2	Select PCI Express port speed.

Note 1: PCI Express Root Port 2 is the mPCIe slot.

## 10.3.1.2 USB Configuration

Aptio Setup Utility – Copyright © 2012 American Megatrends, Inc.

Chipset

<b>USB Configuration</b>		Enable or disable XHCI Pre-Boot Driver support.
XHCI Pre-Boot Driver	[Enabled]	
xHCI Mode	[Smart Auto]	
HS Port #1 Switchable	[Enabled]	
HS Port #2 Switchable	[Enabled]	
HS Port #3 Switchable	[Enabled]	
HS Port #4 Switchable	[Enabled]	
xHCI Streams	[Enabled]	
ECHI1	[Enabled]	
ECHI2	[Enabled]	
USB Ports Per-Port Disable Control	[Disabled]	
		→← : Select Screen ↑↓ : Select Item Enter: Select +/- : Change Opt. F1: General Help F2: Previous Values F3: Optimized Defaults F4: Save & Exit ESC: Exit

Version 2.15.1226. Copyright © 2012 American Megatrends, Inc

Function	Selection	Description
XHCI Pre-Boot Driver	<b>Enabled</b> Disabled	Enable or disable XHCI Pre-Boot Driver support.
xHCI Mode	<b>Smart Auto</b> Auto Enabled Disabled	Mode of operation of xHCI controller.
HS Port #1 Switchable HS Port #2 Switchable HS Port #3 Switchable HS Port #4 Switchable (Note1)	Disabled <b>Enabled</b>	Allows for HS port switching between xHCI and EHCI. If disabled, port is routed to EHCI. If HS port is routed to xHCI, the corresponding SS port is enabled.
xHCI Streams	Disabled <b>Enabled</b>	Enable xHCI Maximum Primary Stream Array Size.
ECHI1	Disabled <b>Enabled</b>	Control the USB EHCI (USB 2.0) functions. One EHCI controller must always be enabled.
ECHI2	Disabled <b>Enabled</b>	Control the USB EHCI (USB 2.0) functions. One EHCI controller must always be enabled.
USB Ports Per-Port Disable Control	<b>Disabled</b> Enabled	Control each of the USB ports (0 – 13) disabling.
USB Port #(0-13) Disabled (Note2)	Disabled <b>Enabled</b>	Disabled USB port.

Note1: Not visible if *xHCI Mode* is Disabled.

Note2: Only visible if *USB Ports Per-Port Disable Control* is Enabled. The USB6 and USB7 are not supported by the KTHM76/mITX.



## 10.3.1.3 PCH Azalia Configuration

Aptio Setup Utility – Copyright © 2012 American Megatrends, Inc.

Chipset

PCH Azalia Configuration		Control Detection of the Azalia device. Disabled = Azalia will be unconditionally disabled. Enabled = Azalia will be unconditionally enabled. Auto = Azalia will be enabled if present, disabled otherwise.
Azalia	[Auto]	
Audio Jack Sensing	[Auto]	
Azalia Internal HDMI codec	[Enabled]	
Azalia HDMI codec Port B	[Enabled]	
Azalia HDMI codec Port C	[Enabled]	
Azalia HDMI codec Port D	[Enabled]	

→← : Select Screen  
 ↑↓ : Select Item  
 Enter: Select  
 +/- : Change Opt.  
 F1: General Help  
 F2: Previous Values  
 F3: Optimized Defaults  
 F4: Save & Exit  
 ESC: Exit

Version 2.15.1226. Copyright © 2012 American Megatrends, Inc

Function	Selection	Description
Azalia	Disabled Enabled <b>Auto</b>	Control Detection of the Azalia device. Disabled = Azalia unconditionally disabled. Enabled = Azalia unconditionally enabled. Auto = Azalia enabled if present, disabled otherwise.
Audio Jack Sensing (Note1)	Disabled <b>Auto</b>	Auto: The insertions of audio jacks are auto determined. Disabled: Driver assumes that all jacks are inserted (useful when using the Audio pinrow)
Azalia Internal HDMI codec (Note1)	Disabled <b>Enabled</b>	Enable or disable internal HDMI codec for Azalia.
Azalia HDMI codec PortB Azalia HDMI codec PortC Azalia HDMI codec PortD (Note2)	Disabled <b>Enabled</b>	Enable or disable internal HDMI codec for Azalia.

Note1: Only visible if *Azalia* is not Disabled.

Note2: Only visible if *Azalia* is not Disabled and *Azalia Internal HDMI codec* is Enabled.

### 10.3.2 System Agent (SA) Configuration

Aptio Setup Utility – Copyright © 2012 American Megatrends, Inc.

Chipset

System Agent Bridge Name	IvyBridge	Check to enable VT-d function on MCH.
System Agent Bridge Name	1.5.0.0	
VT-d Capability	Supported	
VT-d	[Enabled]	→← : Select Screen ↑↓ : Select Item Enter: Select +/- : Change Opt. F1: General Help F2: Previous Values F3: Optimized Defaults F4: Save & Exit ESC: Exit
CHAP Device (B0:D7:F0)	[Disabled]	
Thermal Device (B0:D4:F0)	[Disabled]	
Enable NB CRID	[Disabled]	
BDAT ACPI Table Support	[Disabled]	
C-State Pre-Wake	[Enabled]	
▶ Graphics Configuration ▶ DMI Configuration ▶ NB PCIe Configuration ▶ Memory Configuration ▶ Memory Thermal Configuration ▶ GT – Power Management Control		

Version 2.15.1226. Copyright © 2012 American Megatrends, Inc

Function	Selection	Description
VT-d	Disabled <b>Enabled</b>	Check to enable VT-d function on MCH.
CHAP Device (B0:D7:F0)	Enabled <b>Disabled</b>	Enable or disable SA CHAP Device.
Thermal Device (B0:D4:F0)	Enabled <b>Disabled</b>	Enable or disable SA Thermal Device.
Enable NB CRID	Enabled <b>Disabled</b>	Enable or disable NB CRID Workaround.
BDAT ACPI Table Support	Enabled <b>Disabled</b>	Enables support for the BDAT ACPI Table.
C-State Pre-Wake (Note1)	<b>Enabled</b> Disabled	Controls C-State Pre-Wake feature for ARAT, in SSKPD[57]

Note 1: Only present if Ivy Bridge CPU is used.

## 10.3.2.1 Graphics Configuration

Aptio Setup Utility – Copyright © 2012 American Megatrends, Inc.

Chipset

Graphics Configuration		Graphics turbo IMON current values supported (14 – 31).
IGFX VBIOS Version	2124	
IGFX Frequency	350 MHz	
Graphics Turbo IMON Current	31	
Primary Display	[Auto]	→← : Select Screen ↑↓ : Select Item Enter: Select +/- : Change Opt. F1: General Help F2: Previous Values F3: Optimized Defaults F4: Save & Exit ESC: Exit
Internal Graphics	[Auto]	
GTT Size	[2MB]	
Aperture Size	[256MB]	
DVMT Pre-Allocated	[64M]	
DVMT Total Gfx Mem	[256M]	
Gfx Low Power Mode	[Enabled]	
Graphics Performance Analyzers	[Disabled]	
▶ LCD Control		

Version 2.15.1226. Copyright © 2012 American Megatrends, Inc

Function	Selection	Description
Graphics Turbo IMON Current	<b>31</b>	Graphics turbo IMON current values supported (14 – 31).
Primary Display	<b>Auto</b> IGFX PEG PCI	Select which of IGFX/PEG/PCI Graphics device should be Primary Display Or select SG for Switchable Gfx.
Internal Graphics	<b>Auto</b> Disabled Enabled	Keep IGD enabled based on the setup options.
GTT Size	1MB <b>2MB</b>	Select the GTT Size.
Aperture Size	128MB <b>256MB</b> 512MB	Select the Aperture Size.
DVMT Pre-Allocated	32M, <b>64M</b> , 96M, 128M, 160M, 192M, 224M, 256M, 288M, 320M, 352M, 384M, 416M, 448M, 480M, 512M, 1024M	Select DVMT 5.0 Pre-Allocated (Fixed) Graphics Memory size used by the Internal Graphics Device.
DVMT Total Gfx Mem	128M <b>256M</b> MAX	Select DVMT 5.0 Total Graphics Memory size used by the Internal Graphics Device.
Gfx Low Power Mode	<b>Enabled</b> Disabled	This option is applicable for SSF only.
Graphics Performance Analyzers	Enabled <b>Disabled</b>	Enable or disable Intel Graphics Performance Analyzers Counters.

## 10.3.2.1.1 LCD Control

Aptio Setup Utility – Copyright © 2012 American Megatrends, Inc.		
Chipset		
<b>LCD Control</b>		Select the Video Device which will be activated during POST. This has no effect if external graphics present. Secondary boot display selection will appear based on your selection. VGA modes will be supported only on primary display.
Primary IGFX Boot Display	[VBIOS Default]	
LCD Panel Type	[VBIOS Default]	
SDVO-LFP Panel Type	[VBIOS Default]	
Panel Scaling	[Auto]	
Backlight Control	[PWM Inverted]	
BIA	[Auto]	
Spread Spectrum clock Chip	[Off]	
TV1 Standard	[VBIOS Default]	
TV2 Standard	[VBIOS Default]	
ALS Support	[Disabled]	
Active LFP	[No LVDS]	
Panel Color Depth	[18 Bit]	
		→← : Select Screen ↑↓ : Select Item Enter: Select +/- : Change Opt. F1: General Help F2: Previous Values F3: Optimized Defaults F4: Save & Exit ESC: Exit
Version 2.15.1226. Copyright © 2012 American Megatrends, Inc		

Function	Selection	Description
Primary IGFX Boot Display	<b>VBIOS Default</b> CRT (DVI-A, default 1) EFP (DVI-D, default 1) LFP (LVDS display) EFP3 (DP2 display) EFP2 (DP1, default 2) LFP2	Select the Video Device which will be activated during POST. This has no effect if external graphics present. Secondary boot display selection will appear based on your selection. VGA modes will be supported only on primary display.
LCD Panel Type	<b>VBIOS Default</b> 640x480 LVDS 800x600 LVDS 1024x768 LVDS1 1280x1024 LVDS 1400x1050(RB) LVDS1 1400x1050 LVDS2 1600x1200 LVDS 1366x768 LVDS 1680x1050 LVDS 1920x1200 LVDS 1440x900 LVDS 1600x900 LVDS 1024x768 LVDS2 1280x800 LVDS 1920x1080 LVDS 2048x1536 LVDS	Select LCD panel used by Internal Graphics Device by selecting the appropriate setup item.
SDVO-LFP Panel Type	<b>VBIOS Default</b> 1024x768 SDVO-LFP 1280x1024 SDVO-LFP 1400x1050 SDVO-LFP 1600x1200 SDVO-LFP	Select SDVO panel used by Internal Graphics Device by selecting the appropriate setup item.
Panel Scaling	<b>Auto</b> Off Force Scaling	Select the LCD panel scaling option used by Internal Graphics Device.
Backlight Control	<b>PWM Inverted</b> PWM Normal GMBus Inverted GMBus Normal	Backlight Control Setting
BIA	<b>Auto</b> Disabled Level 1 Level 2 Level 3 Level 4 Level 5	Auto: GMCH use VBT defaults. Level n: Enabled with selected Aggressiveness Level.
Spread Spectrum clock Chip	<b>Off</b> Hardware Software	Hardware: Spread is controlled by chip. Software: Spread is controlled by BIOS.

Function	Selection	Description
TV1 Standard	<b>VBIOS Default</b> NTSC_M NTSC_M_J NTSC_433 PAL_B PAL_G PAL_D PAL_H PAL_I PAL_M PAL_N SECAM_L SECAM_B SECAM_D SECAM_G SECAM_H SECAM_K HDTV_STD_SMPTE_240M_1080i59 HDTV_STD_SMPTE_240M_1080i60 HDTV_STD_SMPTE_295M_1080i50 HDTV_STD_SMPTE_295M_1080p50 HDTV_STD_SMPTE_296M_720p50 HDTV_STD_SMPTE_296M_720p60 HDTV_STD_CEAIEA_7702A_480p60 HDTV_STD_CEAIEA_7702A_480i60	Select the ability to configure a TV Format.
TV2 Standard	<b>VBIOS Default</b> NTSC_M NTSC_M_J NTSC_433 PAL_B PAL_G PAL_D PAL_H PAL_I PAL_M PAL_N SECAM_L SECAM_B SECAM_D SECAM_G SECAM_H SECAM_K HDTV_STD_SMPTE_240M_1080i59 HDTV_STD_SMPTE_240M_1080i60 HDTV_STD_SMPTE_295M_1080i50 HDTV_STD_SMPTE_295M_1080p50 HDTV_STD_SMPTE_296M_720p50 HDTV_STD_SMPTE_296M_720p60 HDTV_STD_CEAIEA_7702A_480p60 HDTV_STD_CEAIEA_7702A_480i60	Select the ability to configure a TV Minor Format.

Function	Selection	Description
ALS Support	Enabled <b>Disabled</b>	Valid only for ACPI. Legacy = ALS Support through the IGD INT10 function. SCPI = ALS support through an ACPI ALS driver.
Active LFP	<b>No LVDS</b> Int-LVDS SDVO LVDS eDP Port-A eDP Port-D	Select the Active LFP Configuration. No LVDS: VBIOS does not enable LVDS. Int-LVDS: VBIOS enables LVDS driver by SDVO encoder. SDVO LVDS: VBIOS enables LVDS driver by SDVO encoder. eDP Port-A: LFP driven by Internal DisplayPort encoder from Port-A.
Panel Color Depth	<b>18 Bit</b> 24 Bit	Select the LFP Panel Color Depth.



## 10.3.2.2 DMI Configuration

Aptio Setup Utility – Copyright © 2012 American Megatrends, Inc.

Chipset

DMI Configuration		Enable or disable DMI Vc1.
DMI	X4 Gen2	
DMI Vc1 Control	[Enabled]	
DMI Vcp Control	[Enabled]	
DMI Vcm Control	[Enabled]	
DMI Link ASPM Control	[L0sL1]	
DMI Extended Synch Control	[Disabled]	
DMI Gen 2	[Auto]	

→← : Select Screen  
↑↓ : Select Item  
Enter: Select  
+/- : Change Opt.  
F1: General Help  
F2: Previous Values  
F3: Optimized Defaults  
F4: Save & Exit  
ESC: Exit

Version 2.15.1226. Copyright © 2012 American Megatrends, Inc

Function	Selection	Description
DMI Vc1 Control	<b>Enabled</b> Disabled	Enable or disable DMI Vc1
DMI Vcp Control	<b>Enabled</b> Disabled	Enable or disable DMI Vcp
DMI Vcm Control	<b>Enabled</b> Disabled	Enable or disable DMI Vcm
DMI Link ASPM Control	Disabled L0s L1 <b>L0sL1</b>	Enable or disable the control of Active State Power Management on SA side of the DMI Link.
DMI Extended Synch Control	Enabled <b>Disabled</b>	Enable DMI Extended Synchronization.
DMI Gen 2	<b>Auto</b> Enabled Disabled	Enable or disable DMI Gen 2. Auto means Disabled for IVB A0 MB/DT and IVB B0 MB, Enabled for other CPUs.

## 10.3.2.3 NB PCIe Configuration

Aptio Setup Utility – Copyright © 2012 American Megatrends, Inc.

Chipset

NB PCIe Configuration		Configure PEG0 B0:D1:F0 Gen1-Gen3
PEG0	Not Present	
PEG0 – Gen X	[Auto]	
PEG0 ASPM	[Disabled]	
PCIe PEG Bifurcation	[1 x16]	
Enable PEG	[Auto]	
Detect Non-Compliance Device	[Disabled]	
De-emphasis Control	[-3.5 dB]	
PEG Sampler Calibrate	[Auto]	
Swing Control	[Full]	
Gen3 Equalization	[Enabled]	
Gen3 Eq Phase 2	[Auto]	
▶ PEG Gen3 Root Port Preset Value for each Lane		
▶ PEG Gen3 Endpoint Preset Value each Lane		
▶ PEG Gen3 Endpoint Hint Value each Lane		
Gen3 Eq Preset Search	[Disabled]	
PEG Link Disabled	[Disabled]	
Fast PEG Init	[Enabled]	
RxCeM Loop back	[Disabled]	
PCIe Gen3 RxCTLEp Setting	12	
		→← : Select Screen ↑↓ : Select Item Enter: Select +/- : Change Opt. F1: General Help F2: Previous Values F3: Optimized Defaults F4: Save & Exit ESC: Exit

Version 2.15.1226. Copyright © 2012 American Megatrends, Inc

Note: PCIe PEG Bifurcation is only supported on KTQM77/mITX having PCB ID 01 (see BIOS Main Menu) or if KTQM77 board has PN 810480-4500 Batch 1400000001 (or above).

Function	Selection	Description
PEG0 – Gen X	<b>Auto</b> GEN1 Gen2	Configure PEG0 B0:D1:F0 Gen1-Gen3
PEG0 ASPM	<b>Disabled</b> Auto ASPM L0s ASPM L1 ASPM L0sL1	Control ASPM support for the PEG: Device 1 Function 0. This has no effect if PEG is not the currently active device.
PCIe PEG Bifurcation	<b>1 x16</b> 2 x8 1 x8, 2 x4	“2 x8” and “1 x8, 2 x4” need Riser Card with bifurcation functionality to work. Only supported on KTQM77/mITX having PCB ID 01 or above.
Enable PEG	Disabled Enabled <b>Auto</b>	To enable or disable the PEG.
Detect Non-Compliance Device	<b>Disabled</b> Enabled	Detect Non-Compliance PCI Express Device in PEG.
De-emphasis Control	-6 dB <b>-3.5 dB</b>	Configuring the De-emphasis Control on PEG.
PEG Sampler Calibrate	<b>Auto</b> Enabled Disabled	Enable or disable PEG Sampler Calibrate. Auto means Disabled for SNB MB/DT, Enabled for IVB A0 B0.
Swing Control	Reduced Half <b>Full</b>	Perform PEG Swing Control, on IVB C0 and Later.
Gen3 Equalization (Note1)	<b>Enabled</b> Disabled	Perform PEG Gen3 Equalization steps.
Gen3 Eq Phase 2 (Note1)	<b>Auto</b> Enabled Disabled	Perform PEG Gen3 Equalization phase 2.
Gen3 Eq Preset Search (Note1)	Enabled <b>Disabled</b>	Perform PEG Gen3 Preset Search algorithm, on IVB Co or Later.
PEG Link Disabled	Enabled <b>Disabled</b>	Enable or disable PCIe link disable mechanism for additional power saving.
Fast PEG Init	<b>Enabled</b> Disabled	Enable or disable Fast PEG Init, Some optimization if not PEG devices present in cold boot.
RxCeM Loop back	<b>Enabled</b> Disabled	Enable or disable RxCeM Loop back.
PCIe Gen3 RxCTLEp Setting (Note1)	0-11, <b>12</b> , 13-15	The range of the setting is (0-15). This setting has to be specified based on platform design and following the guideline.

Note 1: Only present if Ivy Bridge CPU is used.

Aptio Setup Utility – Copyright © 2012 American Megatrends, Inc.

Chipset

PEG Gen3 Root Port Preset Value for each Lane		Value for Lane 0.
Lane 0	8	
Lane 1	8	
Lane 2	8	
Lane 3	8	
Lane 4	8	
Lane 5	8	
Lane 6	8	
Lane 7	8	
Lane 8	8	
Lane 9	8	
Lane 10	8	
Lane 11	8	
Lane 12	8	
Lane 13	8	
Lane 14	8	
Lane 15	8	

→← : Select Screen  
↑↓ : Select Item  
Enter: Select  
+/- : Change Opt.  
F1: General Help  
F2: Previous Values  
F3: Optimized Defaults  
F4: Save & Exit  
ESC: Exit

Version 2.15.1226. Copyright © 2012 American Megatrends, Inc

Aptio Setup Utility – Copyright © 2012 American Megatrends, Inc.

Chipset

PEG Gen3 Endpoint Preset Value each Lane		Value for Lane 0.
Lane 0	7	
Lane 1	7	
Lane 2	7	
Lane 3	7	
Lane 4	7	
Lane 5	7	
Lane 6	7	
Lane 7	7	
Lane 8	7	
Lane 9	7	
Lane 10	7	
Lane 11	7	
Lane 12	7	
Lane 13	7	
Lane 14	7	
Lane 15	7	

→← : Select Screen  
↑↓ : Select Item  
Enter: Select  
+/- : Change Opt.  
F1: General Help  
F2: Previous Values  
F3: Optimized Defaults  
F4: Save & Exit  
ESC: Exit

Version 2.15.1226. Copyright © 2012 American Megatrends, Inc

Aptio Setup Utility – Copyright © 2012 American Megatrends, Inc.

Chipset

PEG Gen3 Endpoint Hint Value each Lane		Value for Lane 0.
Lane 0	2	
Lane 1	2	
Lane 2	2	
Lane 3	2	
Lane 4	2	
Lane 5	2	
Lane 6	2	
Lane 7	2	
Lane 8	2	
Lane 9	2	
Lane 10	2	
Lane 11	2	
Lane 12	2	
Lane 13	2	
Lane 14	2	
Lane 15	2	

→← : Select Screen  
↑↓ : Select Item  
Enter: Select  
+/- : Change Opt.  
F1: General Help  
F2: Previous Values  
F3: Optimized Defaults  
F4: Save & Exit  
ESC: Exit

Version 2.15.1226. Copyright © 2012 American Megatrends, Inc

## 10.3.2.4 Memory Configuration

Aptio Setup Utility – Copyright © 2012 American Megatrends, Inc.

Chipset

Memory Information		Select DIMM timing profile that should be used.
Memory RC Version	1.5.0.0	
Memory Frequency	1333 Mhz	
Total Memory	4096 MB (DDR3)	
DIMM#0	4096 MB (DDR3)	
DIMM#2	Not Present	
CAS Latency (tCL)	9	
Minimum delay time		
CAS to RAS (tRCDmin)	9	
Row Precharge (tRPmin)	9	
Active to Precharge (tRASmin)	24	
XMP Profile 1	Not Supported	
XMP Profile 1	Not Supported	
DIMM profile	[Default DIMM profile]	→← : Select Screen
Memory Frequency Limiter	[Auto]	↑↓ : Select Item
ECC Support	[Enabled]	Enter: Select
Max TOLUD	[Dynamic]	+/- : Change Opt.
NMode Support	[Auto]	F1: General Help
Memory Scrambler	[Enabled]	F2: Previous Values
MRC Fast Boot	[Enabled]	F3: Optimized Defaults
Force Cold Reset	[Enabled]	F4: Save & Exit
DIMM Exit Mode	[Fast Exit]	ESC: Exit
Power Down Mode	[PPD]	

Version 2.15.1226. Copyright © 2012 American Megatrends, Inc

Function	Selection	Description
DIMM profile	<b>Default DIMM profile</b> Custom Profile XMP Profile 1 XMP Profile 2	Select DIMM timing profile that should be used.
Memory Frequency Limiter	<b>Auto</b> 1067 1333 1600 1867 2133 2400 2667	Maximum Memory Frequency Selections in Mhz.
ECC Support	Disabled <b>Enabled</b>	Enable or disable DDR Ecc Support.

Table continued:

Function	Selection	Description
Max TOLUD	<b>Dynamic</b> 1 GB 1.25 GB 1.5 GB 1.75 GB 2 GB 2.25 GB 2.5 GB 2.75 GB 3 GB 3.25 GB	Maximum Value of TOLUD. Dynamic assignment would adjust TOLUD automatically based on largest MMIO length of installed graphic controller.
NMode Support	<b>Auto</b> 1N Mode 2N Mode	Nmode Support Option
Memory Scrambler	<b>Enabled</b> Disabled	Enable or disable memory scrambler.
MRC Fast Boot	<b>Enabled</b> Disabled	Enable or disable MRC Fast Boot
Force Cold Reset	<b>Enabled</b> Disabled	Force cold reset or choose MRC cold reset mode, when cold boot is required during MRC execution. Note: If ME 5.0MB is present, Force cold reset is required!
DIMM Exit Mode	Auto Slow Exit <b>Fast Exit</b>	DIMM Exit Mode control.
Power Down Mode	No Power Down APD <b>PPD</b> APD-PPD	Power Down Mode control.
Scrambler Seed Generation Off	Enabled <b>Disabled</b>	Control Memory Scrambler Seed Generation. Enable – do not generate scrambler seed. Disable – Generate scrambler seed always.
Memory Remap	<b>Enabled</b> Disabled	Enable or disable Memory Remap above 4G.
Memory Alias Check	Enabled <b>Disabled</b>	Enable or disable Memory Alias Check.
Channel A DIMM Control	<b>Enable Both DIMMS</b> Disable DIMM0 Disable DIMM1 Disable Both DIMMS	Enable or disable dims on channel A.
Channel B DIMM Control	<b>Enable Both DIMMS</b> Disable DIMM0 Disable DIMM1 Disable Both DIMMS	Enable or disable dims on channel B.



## 10.3.2.5 Memory Thermal Configuration

Aptio Setup Utility – Copyright © 2012 American Megatrends, Inc.

Chipset

Memory Thermal Configuration		Enable or disable Memory Thermal Management.
Memory Thermal Management	[Enabled]	
PECI Injected Temperature	[Disabled]	
EXTTS# via TS-on-Board	[Disabled]	
EXTTS# via TS-on-DIMM	[Disabled]	
Virtual Temperature Sensor (VTS)	[Disabled]	
		→← : Select Screen ↑↓ : Select Item Enter: Select +/- : Change Opt. F1: General Help F2: Previous Values F3: Optimized Defaults F4: Save & Exit ESC: Exit

Version 2.15.1226. Copyright © 2012 American Megatrends, Inc

Function	Selection	Description
Memory Thermal Management	Disabled <b>Enabled</b>	Enable or disable Memory Thermal Management.
PECI Injected Temperature	Enabled <b>Disabled</b>	Enable or disable memory temperatures to be injected to the processor via Peci.
EXTTS# via TS-on-Board	Enabled <b>Disabled</b>	Enable or disable routing TS-on-Board to be injected to EXTTS# pins on the PCH.
EXTTS# via TS-on-DIMM	Enabled <b>Disabled</b>	Enable or disable routing TS-on-DIMM to be injected to pin on the PCH.
Virtual Temperature Sensor (VTS)	Enabled <b>Disabled</b>	Enable or disable Virtual Temperature Sensor (VTS).

## 10.3.2.6 GT – Power Management Control

Aptio Setup Utility – Copyright © 2012 American Megatrends, Inc.

Chipset

GT – Power Management Control GT Info	GT2 (0x166)	Check to enable render standby support.
RC6 (Render Standby)	[Enabled]	
RC6+(Deep RC6)	[Enabled]	
GT Overclocking Support	[Disabled]	

→← : Select Screen  
↑↓ : Select Item  
Enter: Select  
+/- : Change Opt.  
F1: General Help  
F2: Previous Values  
F3: Optimized Defaults  
F4: Save & Exit  
ESC: Exit

Version 2.15.1226. Copyright © 2012 American Megatrends, Inc

Function	Selection	Description
RC6 (Render Standby)	<b>Enabled</b> Disabled	Check to enable render standby support.
RC6+(Deep RC6)	<b>Enabled</b> Disabled	Check to enable Deep RC6 (RC6+) support.
GT Overclocking Support	Enabled <b>Disabled</b>	Enable or disable GT Overclocking Support.

## 10.4 Boot

Aptio Setup Utility – Copyright © 2012 American Megatrends, Inc.		
Main   Advanced   Chipset   <b>Boot</b>   Security   Save & Exit		
<b>Boot Configuration</b> Setup Prompt Timeout Bootup NumLock State  Quit Boot Fast Boot  CSM16 Module Version  GateA20 Active Option ROM Message INT19 Trap Response  Driver Option Priorities  Boot Option Priorities Boot Option #1 ▶ Force Boot Setup ▶ CSM parameters	1 [On]  [Disabled] [Disabled]  07.69  [Upon Request] [Force BIOS] [Immediate]  [P1: ST3120827AS ...]	Number of seconds to wait for setup activation key. 65535 (0xFFFF) means indefinite waiting.          →← : Select Screen ↑↓ : Select Item Enter: Select +/- : Change Opt. F1: General Help F2: Previous Values F3: Optimized Defaults F4: Save & Exit ESC: Exit
Version 2.15.1226. Copyright © 2012 American Megatrends, Inc		

**Note:** When pressing <F7> while booting it is possible manually to select boot device.

Function	Selection	Description
Setup Prompt Timeout	1, 2 - 65535 (Note)	Number of seconds to wait for setup activation key. 65535 (0xFFFF) means indefinite waiting.
Bootup NumLock State	<b>On</b> Off	Select the Keyboard Numlock state.
Quit Boot	<b>Disabled</b> Enabled	Enables or disables Quiet Boot option.
Fast Boot	<b>Disabled</b> Enabled	Enables or disables boot with initialization of a minimal set of devices required to launch active boot option. Has no effect for BBS boot options.
GateA20 Active	<b>Upon Request</b> Always	Upon Request: GA20 can be disabled using BIOS services. Always: do not allow disabling GA20; this option is useful when any RT code is executed above 1MB.
Option ROM Message	<b>Force BIOS</b> Keep Current	Set display mode for Option ROM.
INT19 Trap Response	<b>Immediate</b> Postponed	BIOS reaction on INT19 trapping by Option ROM. Immediate: execute the trap right away. Postponed: execute the trap during legacy boot.
Boot Option #1	(list of bootable devices)	Sets the system boot order.

Note: To enter number use digit keys and/or +/- keys.

### 10.4.1 Force Boot Setup

Aptio Setup Utility – Copyright © 2012 American Megatrends, Inc.

Boot

Force Boot Setup		This option controls if CSM will be launched.
Force Boot	[Enabled]	
1 <sup>st</sup> Boot	[Sata Port]	→← : Select Screen ↑↓ : Select Item Enter: Select +/- : Change Opt. F1: General Help F2: Previous Values F3: Optimized Defaults F4: Save & Exit ESC: Exit
Port #	1	
2 <sup>nd</sup> Boot	[Device Name]	
Device Name	[ST3120827AS]	
3 <sup>rd</sup> Boot	[USB ]	
4 <sup>th</sup> Boot	[N/A]	

Version 2.15.1226. Copyright © 2012 American Megatrends, Inc

Function	Selection	Description
Force Boot	<b>Disabled</b> Enabled	
1 <sup>st</sup> Boot (2 <sup>nd</sup> Boot) (3 <sup>rd</sup> Boot) (4 <sup>th</sup> Boot)	<b>N/A</b> USB SATA SATA Port Device Name	Note1
Port #	0 - 5	Note2 Note4
Device Name	None ST3120827AS *N/A * *N/A * *N/A *	Note3

Note 1: 1<sup>st</sup> Boot, 2<sup>nd</sup> Boot, 3<sup>rd</sup> Boot and 4<sup>th</sup> Boot have the same set of selections.

Note 2: Only shown if SATA Port is selected.

Note 3: Only shown if Device Name is selected.

Note 4: By +/- key select requested port number. Make sure only valid number (0 – 5) is selected.

## 10.4.2 CSM parameters

Aptio Setup Utility – Copyright © 2012 American Megatrends, Inc.

Boot

Launch CSM	[Always]	This option controls if CSM will be launched.
Boot option filter	[UEFI and Legacy]	
Launch PXE OpROM policy	[Do not launch]	
Launch Storage OpROM policy	[Legacy only]	
Launch Video OpROM policy	[Legacy only]	
Other PCI device ROM priority	[Legacy OpROM]	

→← : Select Screen  
 ↑↓ : Select Item  
 Enter: Select  
 +/- : Change Opt.  
 F1: General Help  
 F2: Previous Values  
 F3: Optimized Defaults  
 F4: Save & Exit  
 ESC: Exit

Version 2.15.1226. Copyright © 2012 American Megatrends, Inc

Function	Selection	Description
Launch CSM	Auto <b>Always</b> Never	This option controls if CSM will be launched.
Boot option filter	<b>UEFI and Legacy</b> Legacy only UEFI only	This option controls what devices system can boot to.
Launch PXE OpROM policy	<b>Do not launch</b> UEFI only Legacy only	Controls the execution of UEFI and Legacy PXE OpROM.
Launch Storage OpROM policy	Do not launch UEFI only <b>Legacy only</b>	Controls the execution of UEFI and Legacy Storage OpROM.
Launch Video OpROM policy	Do not launch UEFI only <b>Legacy only</b>	Controls the execution of UEFI and Legacy Video OpROM.
Other PCI device ROM priority	UEFI OpROM <b>Legacy OpROM</b>	For PCI devices other than Network, Mass storage or Video defines which OpROM to launch.

## 10.5 Security

Aptio Setup Utility – Copyright © 2012 American Megatrends, Inc.

Main | Advanced | Chipset | Boot | **Security** | Save & Exit

<p><b>Password Description</b></p> <p>If ONLY the Administrator's password is set, then this only limits access to Setup and is only asked for when entering Setup.</p> <p>If ONLY the User's password is set, then this is a power on password and must be entered to boot or enter Setup. In Setup the User will have Administrator rights.</p> <p>The password length must be in the following range:</p> <table style="width: 100%; border: none;"> <tr> <td style="width: 80%;">Minimum length</td> <td style="text-align: right;">3</td> </tr> <tr> <td>Maximum length</td> <td style="text-align: right;">20</td> </tr> </table> <p>Administrator Password</p> <p>User Password</p> <p>Password on popup menu <span style="float: right;">[Enabled]</span></p> <p>System Mode state <span style="float: right;">Setup</span></p> <p>Secure Boot state <span style="float: right;">Disabled</span></p> <p>Secure Boot <span style="float: right;">[Enabled]</span></p> <p>Secure Boot Mode <span style="float: right;">[Custom]</span></p> <p>▶ Image Execution Policy</p> <p>▶ Key Management</p> <p>HDD Security Configuration: P1:ST3120827AS</p>	Minimum length	3	Maximum length	20	<p style="text-align: center;">Set Administrator Password</p> <hr/> <p>→← : Select Screen          ↑↓ : Select Item          Enter: Select          +/- : Change Opt.          F1: General Help          F2: Previous Values          F3: Optimized Defaults          F4: Save &amp; Exit          ESC: Exit</p>
Minimum length	3				
Maximum length	20				

Version 2.15.1226. Copyright © 2012 American Megatrends, Inc

Function	Selection	Description
Administrator Password	(See Password description above)	Set Administrator Password
User Password	(See Password description above)	Set User Password
Password on popup menu	Disabled <b>Enabled</b>	Password on F7 popup boot menu.
Secure Boot	Disabled <b>Enabled</b>	Secure Boot flow control. Secure Boot is possible only if System runs in User Mode.
Secure Boot Mode	<b>Standard</b> Custom	Secure Boot mode selector. Standard: fixed Secure boot policy. Custom: changeable Image Execution policy and Secure Boot Key databases.

### 10.5.1 Image Execution Policy

Only visible if *Secure Boot Mode = Custom*.

Aptio Setup Utility – Copyright © 2012 American Megatrends, Inc.

Security

Internal FV	[Always Execute]	Image Execution Policy on Security Violation. Image load device path
Option ROM	[Deny Execute]	
Removable Media	[Deny Execute]	
Fixed Media	[Deny Execute]	
		→← : Select Screen ↑↓ : Select Item Enter: Select +/- : Change Opt. F1: General Help F2: Previous Values F3: Optimized Defaults F4: Save & Exit ESC: Exit

Version 2.15.1226. Copyright © 2012 American Megatrends, Inc

Function	Selection	Description
Internal FV	<b>Always Execute</b>	Image Execution Policy on Security Violation. Image load device path.
Option ROM	Always Execute Always Deny Allow Execute Defer Execute <b>Deny Execute</b> Query User	Image Execution Policy on Security Violation. Image load device path.
Removable Media	Always Execute Always Deny Allow Execute Defer Execute <b>Deny Execute</b> Query User	Image Execution Policy on Security Violation. Image load device path.
Fixed Media	Always Execute Always Deny Allow Execute Defer Execute <b>Deny Execute</b> Query User	Image Execution Policy on Security Violation. Image load device path.



## 10.5.2 Key Management

Only visible if *Secure Boot Mode = Custom*.

Aptio Setup Utility – Copyright © 2012 American Megatrends, Inc.

Security

Default Key Provisioning	[Disabled]	Force OEM default Secure Boot Keys if System is in Setup Mode.
Manage All Factory Keys (PK,KEK;DB,DBX) Install default Secure Boot keys		
Platform Key (PK)	[NOT INSTALLED]	→← : Select Screen ↑↓ : Select Item Enter: Select +/- : Change Opt. F1: General Help F2: Previous Values F3: Optimized Defaults F4: Save & Exit ESC: Exit
▶ Set PK from File		
▶ Get PK to File		
▶ Delete the PK		
Key Exchange Key Database (KEK)	[NOT INSTALLED]	
▶ Set KEK from File		
▶ Get KEK to File		
▶ Delete the KEK		
▶ Append an entry to KEK		
Key Exchange Key Database (DB)	[NOT INSTALLED]	
▶ Set DB from File		
▶ Get DB to File		
▶ Delete the DB		
▶ Append an entry to DB		
Key Exchange Key Database (DBX)	[NOT INSTALLED]	
▶ Set DBX from File		
▶ Get DBX to File		
▶ Delete the DBX		
▶ Append an entry to DBX		

Version 2.15.1226. Copyright © 2012 American Megatrends, Inc

Function	Selection	Description
Default Key Provisioning	<b>Disabled</b> Enabled	Force OEM default Secure Boot Keys if System is in Setup Mode.

### 10.5.3 HDD Security Configuration

Only visible if entering a device listed below HDD Security Configuration.

Aptio Setup Utility – Copyright © 2012 American Megatrends, Inc.

Security

<p>HDD Password Description :</p> <p>Allows Access to set, Modify and Clear HardDisk User and Master Passwords. User Password need to be installed for Enabling Security. Master Password can be modified only when successfully unlocked with Master Password in POST.</p> <p>HDD PASSWORD CONFIGURATION:</p> <p>Security Supported : Yes          Security Enabled : No          Security Locked : No          Security Frozen : No          HDD User Pwd Status NOT INSTALLED          HDD Master Pwd Status INSTALLED</p> <p>Set User Password</p>	<p>Set HDD User Password.          *** Advisable to Power Cycle System after Setting Hard Disk Passwords ***</p>
	<p>→← : Select Screen          ↑↓ : Select Item          Enter: Select          +/- : Change Opt.          F1: General Help          F2: Previous Values          F3: Optimized Defaults          F4: Save &amp; Exit          ESC: Exit</p>

Version 2.15.1226. Copyright © 2012 American Megatrends, Inc

Function	Selection	Description
Set User Password	<b>Create New Password</b>	Set HDD User Password. *** Advisable to Power Cycle System after Setting Hard Disk Passwords ***

## 10.6 Save & Exit

This Menu is special; having no “selections” for each function, or in other words, the function is the same as the selection.

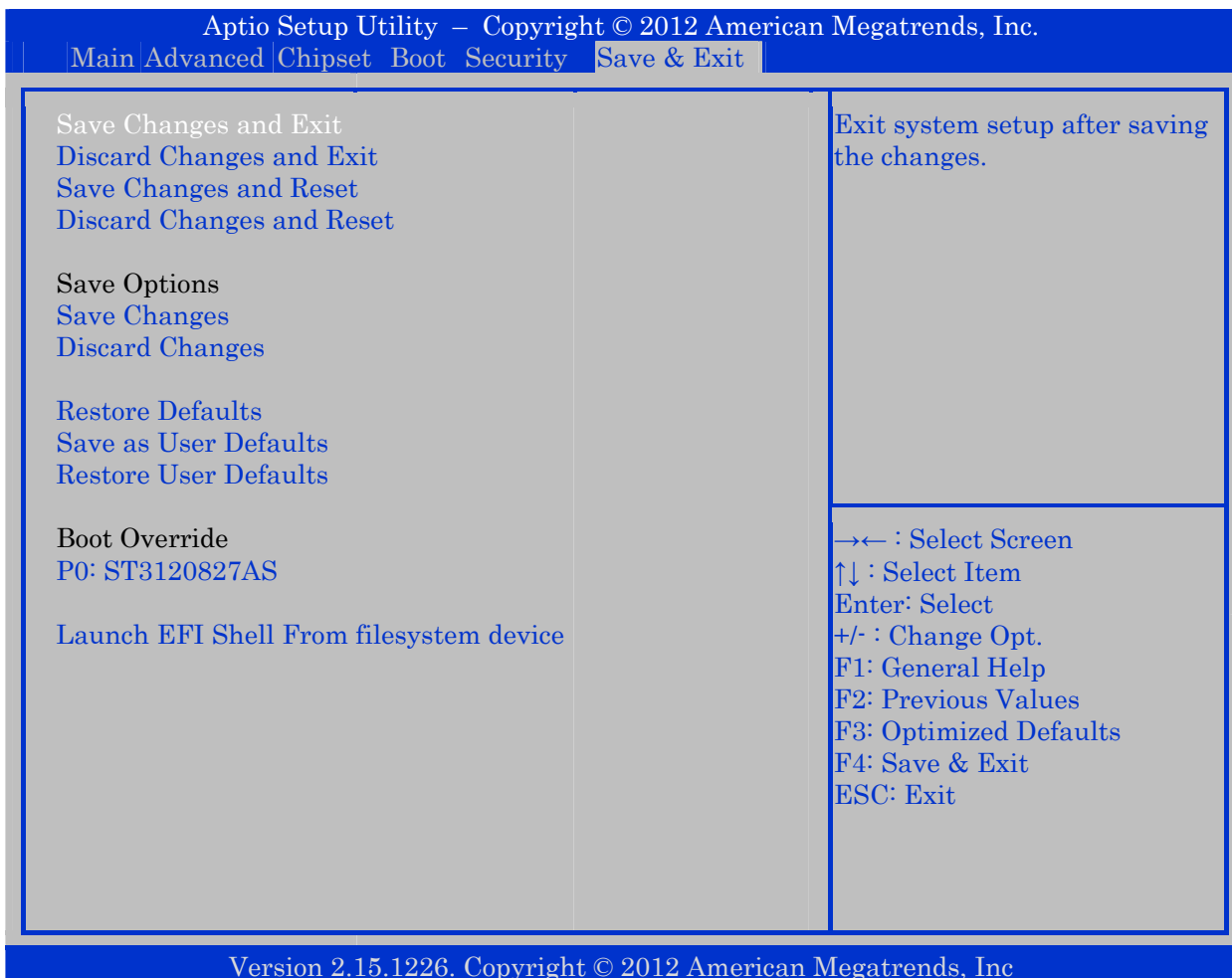

Function	Description
Save Changes and Exit	Exit system setup after saving the changes.
Discard Changes and Exit	Exit system setup without saving any changes.
Save Changes and Reset	Reset the system after saving the changes.
Discard Changes and Reset	Reset the system without saving any changes.
Save Changes	Save Changes done so far to any of the setup options.
Discard Changes	Discard Changes done so far to any of the setup options.
Restore Defaults	Restore/Load Default values for all the setup options.
Save as User Defaults	Save the Changes done so far as User Defaults.
Restore User Defaults	Restore the User Defaults to all the setup options.
(possible list of boot devices)	Selection table of bootable devices. When selected system will boot on selected device. (See note below)
Launch EFI Shell From filesystem device	Attempts to Launch EFI Shell application (Shellx64.efi) from one of the available filesystem devices.

**Note:** When pressing <F7> while booting it is possible manually to select boot device.

## 11 AMI BIOS Beep Codes

### Boot Block Beep Codes:

Number of Beeps	Description
1	Insert diskette in floppy drive A:
2	'AMIBOOT.ROM' file not found in root directory of diskette in A:
3	Base Memory error
4	Flash Programming successful
5	Floppy read error
6	Keyboard controller BAT command failed
7	No Flash EPROM detected
8	Floppy controller failure
9	Boot Block BIOS checksum error
10	Flash Erase error
11	Flash Program error
12	'AMIBOOT.ROM' file size error
13	BIOS ROM image mismatch (file layout does not match image present in flash device)

### POST BIOS Beep Codes:

Number of Beeps	Description
1	Memory refresh timer error.
2	Parity error in base memory (first 64KB block)
3	Base memory read/write test error
4	Motherboard timer not operational
5	Processor error
6	8042 Gate A20 test error (cannot switch to protected mode)
7	General exception error (processor exception interrupt error)
8	Display memory error (system video adapter)
9	AMIBIOS ROM checksum error
10	CMOS shutdown register read/write error
11	Cache memory test failed

### Troubleshooting POST BIOS Beep Codes:

Number of Beeps	Troubleshooting Action
1, 2 or 3	Reset the memory, or replace with known good modules.
4-7, 9-11	Fatal error indicating a serious problem with the system. Consult your system manufacturer. Before declaring the motherboard beyond "all hope", eliminate the possibility of interference due to a malfunctioning add-in card. Remove all expansion cards, except the video adapter. <ul style="list-style-type: none"> <li>• If beep codes are generated when all other expansion cards are absent, consult your system manufacturer's technical support.</li> <li>• If beep codes are not generated when all other expansion cards are absent, one of the add-in cards is causing the malfunction. Insert the cards back into the system one at a time until the problem happens again. This will reveal the malfunctioning card.</li> </ul>
8	If the system video adapter is an add-in card, replace or reset the video adapter. If the video adapter is an integrated part of the system board, the board may be faulty.

Note: If Motherboard beeps fast for approximately two seconds (~20 beeps) and then turns off, then Jumper (J37) is missing, meaning that "Load Default BIOS Settings" function is enabled until J37 is back in place.

## 12 OS Setup

Use the Setup.exe files for all relevant drivers. The drivers can be found on KTQM77 Driver CD or they can be downloaded from the homepage <http://www.kontron.com/>

For some OS like Win7 when installing OS via USB DVD, USB Keyboard/Mouse, please connect the USB DVD, USB Keyboard/Mouse to USB2.0 ports only or disable USB3.0 in BIOS.