

# » Kontron User's Guide «

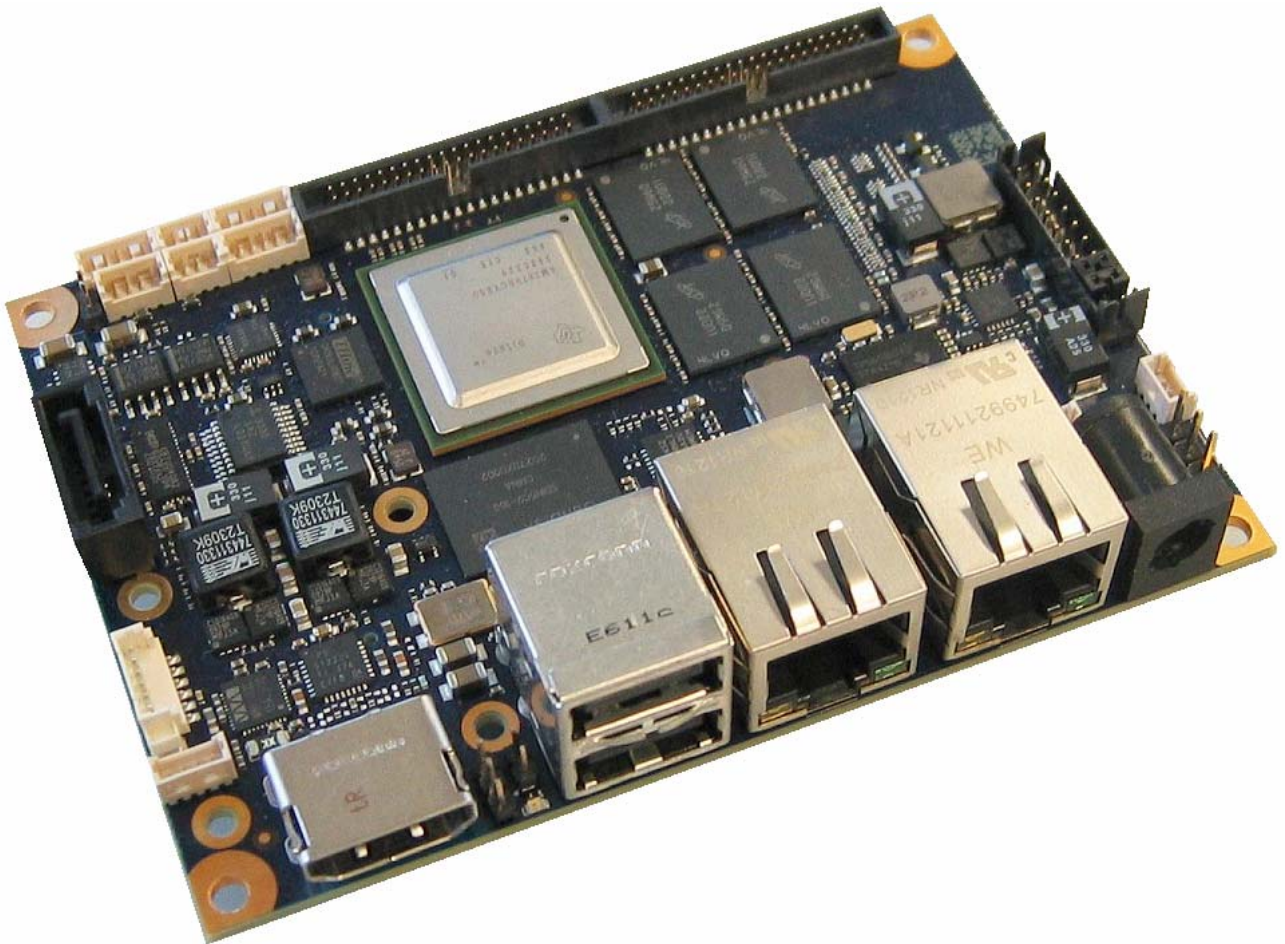

**KTAM3874/pITX**

KTD-S0051-D

 **Pico™**

# » Table of Contents «

<b>1</b>	<b>User Information .....</b>	<b>1</b>
1.1	About This Document .....	1
1.2	Copyright Notice .....	1
1.3	Trademarks .....	1
1.4	Standards .....	1
1.5	Warranty.....	1
1.6	Life Support Policy.....	2
1.7	Technical Support.....	2
<b>2</b>	<b>Introduction .....</b>	<b>3</b>
2.1	pITX Embedded Line Family .....	3
2.2	KTAM3874/pITX Overview.....	3
<b>3</b>	<b>Specifications .....</b>	<b>4</b>
3.1	Functional Specifications .....	4
3.2	Block Diagram.....	6
3.3	Mechanical Specifications .....	7
3.4	Electrical Specifications .....	7
3.5	Real-Time Clock Battery .....	8
3.6	Environmental Specifications.....	8
3.7	MTBF.....	9
<b>4</b>	<b>Connector Locations .....</b>	<b>10</b>
4.1	I/O Connector Definitions .....	11
<b>5</b>	<b>Graphics Processing Subsystem.....</b>	<b>12</b>
5.1	HDMI® Connector .....	12
5.2	LVDS Flat Panel Connector.....	13
5.3	Connecting a Flat Panel .....	14
5.4	Flat Panel Power Jumper .....	14
5.5	Backlight .....	15
5.5.1	Power Connector Backlight Pins .....	15
5.5.2	LVDS Connector Backlight Pins.....	16
5.5.3	External Backlight Voltage Parameter.....	16
<b>6</b>	<b>USB Interface .....</b>	<b>17</b>
6.1	Standard Connector .....	17
6.2	Extension Connectors.....	17
6.3	Limitations.....	18

<b>7</b>	<b>LAN Interface .....</b>	<b>19</b>
7.1	Connectors.....	19
<b>8</b>	<b>Serial-ATA® Interface.....</b>	<b>20</b>
8.1	Connector .....	20
<b>9</b>	<b>CAN Interface .....</b>	<b>21</b>
9.1	Connectors.....	21
<b>10</b>	<b>Serial Interface.....</b>	<b>22</b>
10.1	Maximum Transfer Rates .....	22
10.2	Connectors.....	22
10.3	RS422/RS485 Interface .....	23
10.4	UART5 Configuration .....	23
10.5	Serial Console .....	24
<b>11</b>	<b>Audio Interface .....</b>	<b>25</b>
11.1	Audio Hardware Features .....	25
11.2	Analog Connector.....	25
11.3	Speaker Connector.....	25
11.3.1	Speaker Hardware Features .....	26
<b>12</b>	<b>Secure Digital and Multimedia Card.....</b>	<b>27</b>
12.1	Connector .....	27
<b>13</b>	<b>PCI Express® Interface.....</b>	<b>28</b>
13.1	Connector .....	28
<b>14</b>	<b>Digital I/O Interface .....</b>	<b>30</b>
14.1	Multifunction Overview.....	30
14.2	Electrical Specifications .....	31
14.3	Connector 1.....	32
14.4	Connector 2.....	33
<b>15</b>	<b>Power Supply .....</b>	<b>35</b>
15.1	DC Power Connector .....	35
15.2	External Power Connector .....	35
15.3	Default Power Configuration .....	36
15.4	Power Front Panel Header .....	37
15.4.1	Power LEDs.....	37
15.5	Onboard Status LED .....	38
15.6	Real-Time Clock Battery Connector.....	38
<b>16</b>	<b>Boot Order.....</b>	<b>39</b>

Appendix A: System Resources .....	40
A.1 Memory Area .....	40
A.2 I <sup>2</sup> C™ Bus .....	40
Appendix B: Mechanical Dimensions .....	41
Appendix C: Connector Overview .....	43
C.1 Mating Connectors .....	43
C.2 Pinout Tables .....	44
Appendix D: Reference Documents .....	47
Appendix E: Certifications .....	48
Appendix F: Document Revision History .....	51

# 1 User Information

## 1.1 About This Document

This document provides information about products from KONTRON Technology A/S and/or its subsidiaries. No warranty of suitability, purpose or fitness is implied. While every attempt has been made to ensure that the information in this document is accurate the information contained within is supplied "as-is" - no liability is taken for any inaccuracies. Manual is subject to change without prior notice.

KONTRON assumes no responsibility for the circuits, descriptions and tables indicated as far as patents or other rights of third parties are concerned.

## 1.2 Copyright Notice

Copyright © 2012 - 2013, KONTRON Technology A/S, ALL RIGHTS RESERVED.

No part of this document may be reproduced or transmitted in any form or by any means, electronically or mechanically, for any purpose without the express written permission of KONTRON Technology A/S.

## 1.3 Trademarks

Brand and product names are trademarks or registered trademarks of their respective owners.

## 1.4 Standards

KONTRON Technology A/S is certified to ISO 9000 standards.

## 1.5 Warranty

This product is warranted against defects in material and workmanship for the warranty period from the date of shipment. During the warranty period KONTRON Technology A/S will at its discretion decide to repair or replace defective products.

Within the warranty period the repair of products is free of charge as long as warranty conditions are observed.

The warranty does not apply to defects resulting from improper or inadequate maintenance or handling by the buyer, unauthorized modification or misuse, operation outside of the product's environmental specifications or improper installation or maintenance.

KONTRON Technology A/S will not be responsible for any defects or damages to third party products that are caused by a faulty KONTRON Technology A/S product.

## 1.6 Life Support Policy

KONTRON Technology's products are not for use as critical components in life support devices or systems without express written approval of the general manager of KONTRON Technology A/S.

As used herein:

Life support devices or systems are devices or systems which

- a) are intended for surgical implant into body or
- b) support or sustain life and whose failure to perform, when properly used in accordance with instructions for use provided in the labelling, can be reasonably expected to result in significant injury to the user.

A critical component is any component of a life support device or system whose failure to perform can be reasonably expected to cause the failure of the life support device or system or to affect its safety or effectiveness.

## 1.7 Technical Support

Please consult our web site at <http://www.kontron.com/support> for the latest product documentation, utilities, drivers and [support contacts](#) or use the special e-mail address [sbc-support@kontron.com](mailto:sbc-support@kontron.com) for a technical problem. In any case you can always contact your board supplier for technical support.

Before contacting support please be prepared to provide as much information as possible:

### Board identification:

- Type
- Part number (find PN on label)
- Serial number (find SN on label)

### System environment:

- O/S type and version
- Driver origin and version
- Attached hardware (drives, USB devices, LCD panels ...)

## 2 Introduction

### 2.1 pITX Embedded Line Family

Each pITX is a member of the 2.5" SBC family of KONTRON Technology A/S based on the Pico-ITX™ specification (only mechanical outer dimensions) from the Small Form Factor Special Interest Group (SFF-SIG).

pITX embedded line modules are characterized by the same front-line pinouts and interfaces for reset logic and simple power supply, 2 x USB, LAN, Audio, GPIOs, DVI® or HDMI® and LVDS interface. These embedded line family features allow to use the same chassis over the whole product line and maximize design reuse. These homogeneous features facilitate easy upgrades within the pITX embedded line product family.

### 2.2 KTAM3874/pITX Overview

Please refer to the following matrix to choose the product that suits your needs best.

Article Number	SDRAM Size	e.MMC Flash	Comment
03005-1040-90-0	1 GByte	4 GByte	Standard
03005-2040-90-0	2 GByte	4 GByte <sup>1)</sup>	On request

---

**Note:** <sup>1)</sup> maximal 16 GByte possible.

---

## 3 Specifications

### 3.1 Functional Specifications

#### System on Chip (SoC): TI® AM3874 Sitara™

- ❑ ARM® Cortex™-A8 core up to 800 MHz core frequency
- ❑ ARMv7 instruction set
- ❑ 32 kB data and 32 kB instruction L1 cache
- ❑ 512 kB L2 cache
- ❑ Dual DDR2/DDR3 memory interface up to DDR3-800 with maximum size of 2 GB
- ❑ One SPI™ controller with four channels (only three channels available)
- ❑ Dual port Ethernet (10/100/1000 Mb/s) with optional switch (only 10/100 Mb/s possible)
- ❑ Two USB ports (EHCI) with one client interface
- ❑ One PCI Express® 2.0 port (x 1 lane) with integrated PHY
- ❑ High Definition Video Processing Sub-System (HDVPSS) supports two independent digital outputs (DVO)
- ❑ One S-ATA® 2.0 controller with integrated PHY
- ❑ Dual Controller Area Network (CAN) modules
- ❑ Six multi-channel audio serial ports (only one port available)
- ❑ Three Secure Digital / MultiMedia Card (SD/MMC) controller (only two ports available)
- ❑ Some pins are useable as GPIOs (max. 38 x 3.3V) or as special function pins (e.g. UART, I<sup>2</sup>C™ and SPI™ functionality)
- ❑ Six UARTs with 16C750 compatible mode (only five UARTs available)

#### Onchip SPI™ Controller

- ❑ Supports FIFO and DMA mode access
- ❑ Maximum transfer rate of 48 Mbits/s

#### Onchip Dual Port Ethernet Controller

- ❑ Fully compliant with IEEE802.3®, IEEE802.3u® and IEEE802.3ab®
- ❑ Full duplex mode supported with 10/100/1000 Mbps (only 10/100 Mbps possible)
- ❑ The Physical Layer Transceiver limits the transfer rate to 100 Mbps

#### Onchip Universal Serial Bus (USB)

- ❑ All ports are capable to handle USB 2.0 (EHCI)
- ❑ Alternatively both ports support USB client (OTG) functionality
- ❑ Supports USB 1.1 low and full speed devices



### Onchip PCI Express® Port

- ❑ Single mini PCIe® port with single lane at 5 GT/s complies with specification rev. 2.0

### Onchip High Definition Video Processing Subsystem

- ❑ Two independent display controllers support 2D/3D graphics rendering (SGX530 3D engine)
- ❑ OpenGL® ES 1.1/2.0, Direct3D mobile and OpenVG 1.0 support
- ❑ HDMI® 1.3a compliant transmitter up to 162 MHz (max. 1920x1080 pixel)
- ❑ Low Voltage Differential Signaling (LVDS) panel interface (based on DVO output) supports 18/24 bit color depth with a maximal resolution of 1920x1080 pixel

### Onchip Serial-ATA® Controller

- ❑ Complies with Serial-ATA® specification rev. 1.0a (1.5 Gb/s) and 2.0 (3 Gb/s)
- ❑ The controller supports AHCI specification rev. 1.1

### Onchip Dual CAN Modules

- ❑ Support for CAN protocol rev. 2.0 part A, B
- ❑ The module RAM allows a storage of 64 messages

### Onchip Audio Subsystem

- ❑ Codec interface realize the Inter-IC Sound (I<sup>2</sup>S) specification
- ❑ The audio codec supports a maximal resolution of 24 bit with 96 kHz sample rate

### Onchip SD/MMC Controllers

- ❑ 1/4/8 bit data bus width
- ❑ Supports FIFO and DMA mode access
- ❑ One controller is reserved for the onboard e.MMC flash drive
- ❑ The second controller supports only a microSD™ slot
- ❑ Supports SDMEM/SDIO specification V2.0 up to 48 MHz interface speed
- ❑ Supports MMC specification V4.3 up to 48 MHz interface speed

### Onchip Serial Interfaces (UARTs)

- ❑ One UART interface is software configurable as RS232C or RS422/RS485

### USB Hub (USB connection): SMSC® USB2514B

- ❑ Four additional USB 2.0 (EHCI) ports (one for the mini PCI Express® connector)
- ❑ Supports also USB 1.1 low and full speed devices

### 3.2 Block Diagram

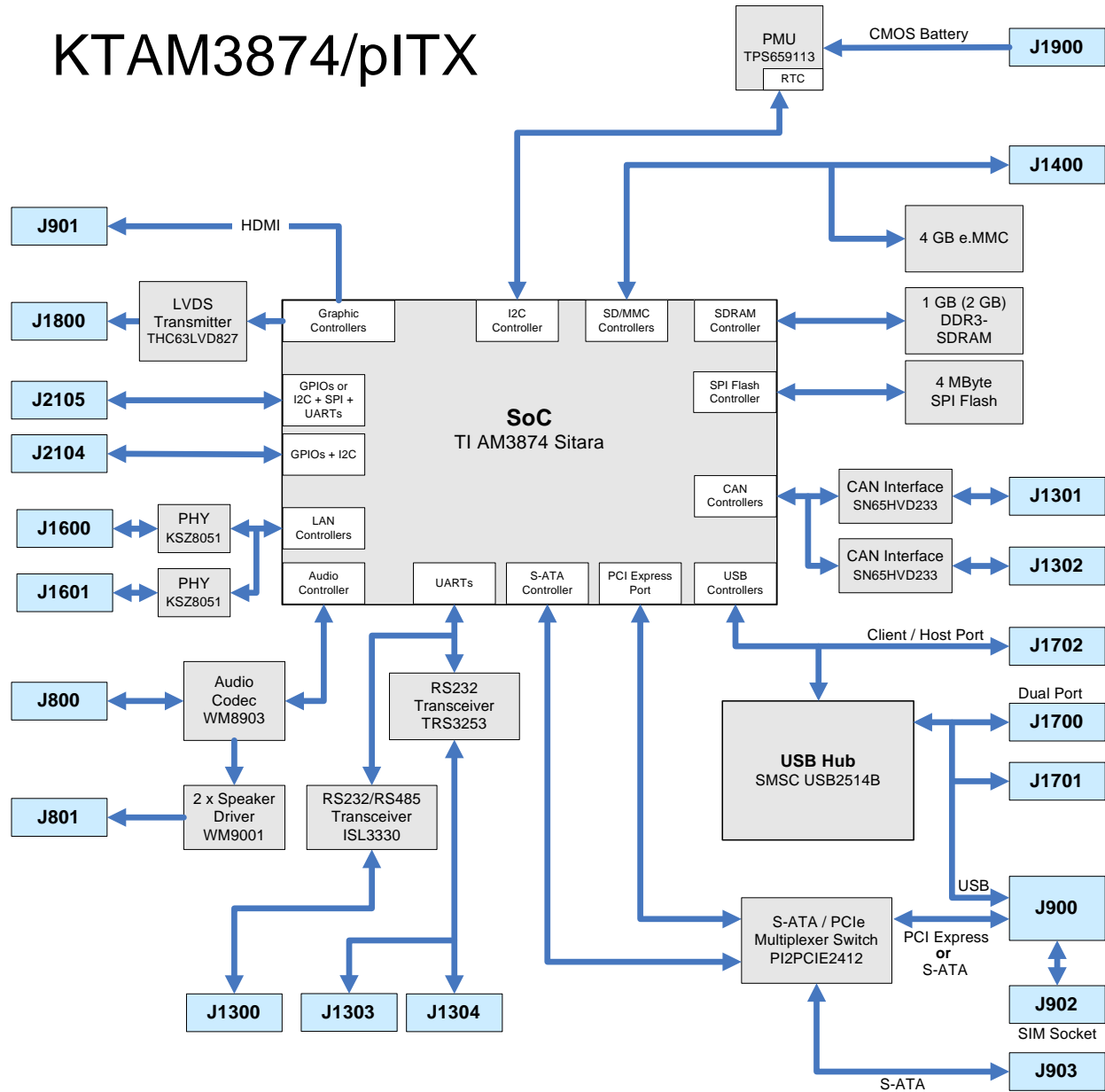

### 3.3 Mechanical Specifications

#### Dimensions

- Pico-ITX™ form factor 100 x 72 mm ±0.2 mm
- Height approx. 26 mm

### 3.4 Electrical Specifications

#### Supply Voltage

- 5V DC ± 5%

#### Supply Voltage Ripple

- Maximum 100mV peak to peak 0 – 20 MHz

#### Supply Current (Linux®)

The power consumption test uses a tool to stress the CPU (100% load) and at the same time another tool to generate a high graphic throughput. The boards were tested with a HDMI® monitor, USB keyboard & mouse and a 4 GByte microSD™ card as boot device.

Variant: 1 GB SDRAM / 4 GB e.MMC						Variant: 2 GB SDRAM / 4 GB e.MMC					
Full Load		Idle		Deep Sleep <sup>1)</sup>		Full Load		Idle		Deep Sleep <sup>1)</sup>	
[A]	[W]	[A]	[W]	[A]	[W]	[A]	[W]	[A]	[W]	[A]	[W]
1.18	5.90	0.98	4.90	0.67	3.35	tbd.	tbd.	tbd.	tbd.	tbd.	tbd.

---

**Note:** <sup>1)</sup> Added kernel parameter 'single' to U-Boot environment.

---

### 3.5 Real-Time Clock Battery

- Voltage range: +2.4V - +3.6V (typ. +3.0V)
- Typical current: 5µA @ +3.0V

Lithium battery precautions

<b>CAUTION!</b>	<b>VORSICHT!</b>
Danger of explosion if battery is incorrectly replaced. Replace only with same or equivalent type recommended by manufacturer. Dispose of used batteries according to the manufacturer's instructions.	Explosionsgefahr bei unsachgemäßem Austausch der Batterie. Ersatz nur durch den selben oder einen vom Hersteller empfohlenen gleichwertigen Typ. Entsorgung gebrauchter Batterien nach Angaben des Herstellers.
<b>ATTENTION!</b>	<b>PRECAUCION!</b>
Risque d'explosion avec l'échange inadéquat de la batterie. Remplacement seulement par le même ou un type équivalent recommandé par le producteur. L'évacuation des batteries usagées conformément à des indications du fabricant.	Peligro de explosión si la batería se sustituye incorrectamente. Sustituya solamente por el mismo o tipo equivalente recomendado por el fabricante. Disponga las baterías usadas según las instrucciones del fabricante.
<b>ADVARSEL!</b>	<b>ADVARSEL!</b>
Lithiumbatteri – Eksplosjonsfare ved feilagtig håndtering. Utskiftning må kun ske med batteri af samme fabrikat og type. Levér det brugte batteri tilbage til leverandøren.	Eksplosjonsfare ved feilaktig skifte av batteri. Benytt samme batteritype eller en tilsvarende type anbefalt av apparatfabrikanten. Brukte batterier kasseres i henhold til fabrikantens instruksjoner.
<b>WARNING!</b>	<b>VAROITUS!</b>
Explosionsfara vid felaktigt batteribyte. Använd samma batterityp eller en ekvivalent typ som rekommenderas av apparattillverkaren. Kassera använt batteri enligt fabrikantens instruktion.	Paristo voi räjähtää, jos se on virheellisesti asennettu. Vaihda paristo ainoastaan laltevalmistajan suosittelemaan tyyppiin. Hävitä käytetty paristo valmistajan ohjeiden mukaisesti.

### 3.6 Environmental Specifications

#### Temperature

Operating (with original KONTRON heat spreader):

- Ambient temperature: -40 to +85°C (E2) <sup>1)</sup>

Non operating:

- Ambient temperature: -55 to +125°C

---

**Note:** 1) It is the customer's responsibility to provide sufficient airflow around each of the components to keep them within the allowed temperature range.

---

## Humidity

- Operating: 10% to 90% (non condensing)
- Non operating: 5% to 95% (non condensing)

## Restriction of Hazardous Substances (RoHS)

All boards in the pITX embedded line product family are RoHS compliant.

## 3.7 MTBF

The following MTBF (Mean Time Between Failure) values were calculated using a combination of manufacturer's test data, if the data was available, and a Bellcore calculation for the remaining parts. The Bellcore calculation used is 'method 1 case 1'. In that particular method the components are assumed to be operating at a 50% stress level in a 40°C ambient environment and the system is assumed to have not been burned in. Manufacturer's data has been used wherever possible. The manufacturer's data, when used, is specified at 50°C, so in that sense the following results are slightly conservative. The MTBF values shown below are for a 40°C in an office or telecommunications environment. Higher temperatures and other environmental stresses (extreme altitude, vibration, salt water exposure, etc.) cause lower MTBF values.

- System MTBF (hours): 220883

---

**Note:** Fans usually shipped with KONTRON Technology A/S products have 50.000-hour typical operating life. The above estimation assumes no fan but a passive heat sinking arrangement. Estimated RTC battery life (as opposed to battery failures) is not included in the MTBF calculation. The RTC battery lifetime has to be considered separately. Battery life depends on both temperature and operating conditions. When the KONTRON unit has external power; the only battery drain is from leakage paths.

---

## 4 Connector Locations

**Note:** Use this picture for pin 1 identification - not the drawings in the individual chapters.

### Top View

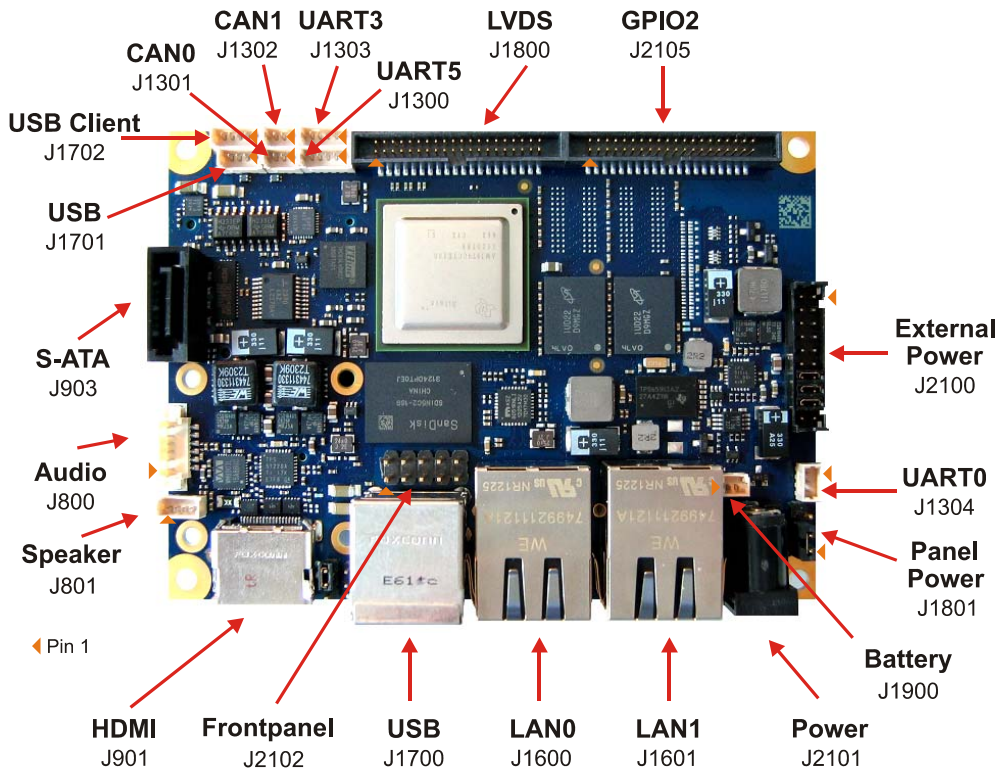

### Bottom View

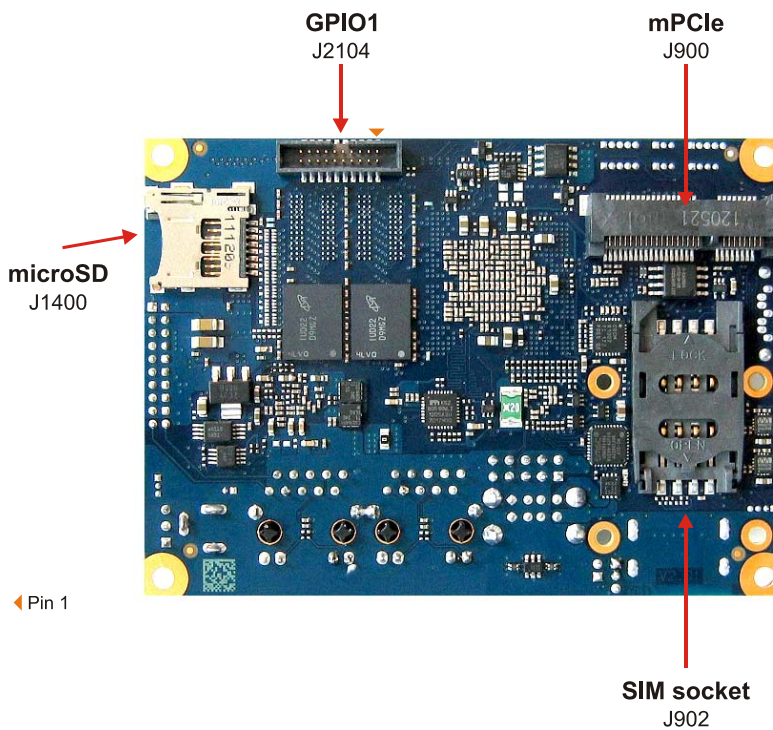

## 4.1 I/O Connector Definitions

The following sections provide pin definitions and detailed description of all onboard connectors. The connector definitions use the following notation:

Column Name	Description
<b>Pin</b>	Shows the pin numbers in the connector.
<b>Signal</b>	The mnemonic name of the signal at the current pin. The notation “#” states that the signal is active low.
<b>Type</b>	AI: <u>A</u> nalogue <u>I</u> nput AO: <u>A</u> nalogue <u>O</u> utput I: <u>D</u> igital <u>I</u> nput IO: <u>D</u> igital <u>I</u> nput / <u>O</u> utput IOD: <u>I</u> nput / <u>O</u> pen- <u>D</u> rain output O: <u>D</u> igital <u>O</u> utput OD: <u>O</u> utput, open- <u>D</u> rain DSO: <u>D</u> ifferential <u>S</u> ignaling <u>O</u> utput with complementary signals on two paired wires DSI: <u>D</u> ifferential <u>S</u> ignaling <u>I</u> nput with complementary signals on two paired wires DSIO: <u>D</u> ifferential <u>S</u> ignaling <u>I</u> nput / <u>O</u> utput (combined DSO and DSI) PWR: <u>P</u> o <u>W</u> e <u>R</u> supply or ground reference pins NC: <u>N</u> ot <u>C</u> onected <u>Additional notations:</u> -50      +5.0V signal voltage level, e.g. I-50 -33      +3.3V signal voltage level, e.g. 0-33 -18      +1.8V signal voltage level, e.g. IO-18
<b>Ioh/Iol</b>	Ioh: Typical current in mA flowing out of an output pin through a grounded load while the output voltage has high level. Iol: Typical current in mA flowing into an output pin from a VCC connected load while the output voltage has low level.

The abbreviation **tbd.** is used for specifications which are not available yet or which are not sufficiently specified by the component vendors.

## 5 Graphics Processing Subsystem

The graphics accelerator supports a HDMI<sup>®</sup> interface with Full HD resolution and a variety of LVDS LCD panels with double clock, color depths of 18/24 bit and resolutions up to 1920 x 1080 pixel.

### 5.1 HDMI<sup>®</sup> Connector

The HDMI<sup>®</sup> interface is available through the standard 19 pin Type A HDMI<sup>®</sup> connector J901.

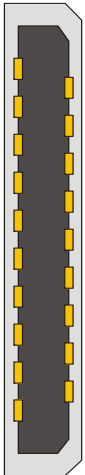
Header	Pin	Signal	Description	Type
	1	<b>TMDS2+</b>	TMDS data 2 (positive)	DS0-33
	2	<b>GND</b>	Ground	PWR
	3	<b>TMDS2-</b>	TMDS data 2 (negative)	DS0-33
	4	<b>TMDS1+</b>	TMDS data 1 (positive)	DS0-33
	5	<b>GND</b>	Ground	PWR
	6	<b>TMDS1-</b>	TMDS data 1 (negative)	DS0-33
	7	<b>TMDS0+</b>	TMDS data 0 (positive)	DS0-33
	8	<b>GND</b>	Ground	PWR
	9	<b>TMDS0-</b>	TMDS data 0 (negative)	DS0-33
	10	<b>TMDS_CLK+</b>	TMDS clock (positive)	DS0-33
	11	<b>GND</b>	Ground	PWR
	12	<b>TMDS_CLK-</b>	TMDS clock (negative)	DS0-33
	13	<b>CEC</b>	<u>C</u> onsumer <u>E</u> lectronics <u>C</u> ontrol	IO-50
	14	<b>N.C.</b>	Not connected	NC
	15	<b>DDC_CLK</b>	DDC clock	IO-50
	16	<b>DDC_DATA</b>	DDC data	IO-50
	17	<b>GND</b>	Ground	PWR
	18	<b>VCC5<sup>1)</sup></b>	Power +5V	PWR
	19	<b>TMDS_HPD</b>	Hotplug detect	I-50

**Note:** 1) To protect the external power lines of peripheral devices make sure that

- the wires have the right diameter to withstand the maximum available current.
- to enclosure of the peripheral device fulfills the fire-protecting conditions of IEC/EN 60950.



## 5.2 LVDS Flat Panel Connector

The J1800 connector (40 pins) provides the LVDS interface for flat panels on the top side of the board. A prototype cable with open ends is available (part number 821515).

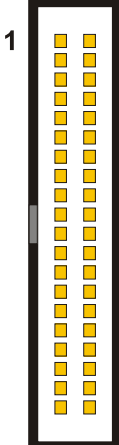
Header	Pin	Signal	Description	Type
	1 - 5	<b>VDD</b> <sup>1)</sup>	Backlight voltage	PWR
	6	<b>GND</b>	Ground	PWR
	7	<b>VCC5</b> <sup>1)</sup>	Power +5V	PWR
	8	<b>GND</b>	Ground	PWR
	9	<b>PANELVCC</b> <sup>1)</sup>	Panel power +3.3V or +5V	PWR
	10	<b>PANELVCC</b> <sup>1)</sup>	Panel power +3.3V or +5V	PWR
	11	<b>DDC_CLK</b>	Panel DDC clock (linked to panel power)	IO-33/IO-50
	12	<b>DDC_DATA</b>	Panel DDC data (linked to panel power)	IO-33/IO-50
	13	<b>BKLTADJ</b>	Brightness control (0V to +5V)	A0
	14	<b>VCCENA</b>	Panel power enable (PANELVCC signal)	0-33
	15	<b>BKLTON</b>	Backlight on/off	0-33
	16	<b>GND</b>	Ground	PWR
	17	<b>FTX0-</b>	First channel data 0 output (negative)	DS0-33
	18	<b>FTX0+</b>	First channel data 0 output (positive)	DS0-33
	19	<b>FTX1-</b>	First channel data 1 output (negative)	DS0-33
	20	<b>FTX1+</b>	First channel data 1 output (positive)	DS0-33
	21	<b>FTX2-</b>	First channel data 2 output (negative)	DS0-33
	22	<b>FTX2+</b>	First channel data 2 output (positive)	DS0-33
	23	<b>FTXC-</b>	First channel clock output (negative)	DS0-33
	24	<b>FTXC+</b>	First channel clock output (positive)	DS0-33
	25	<b>FTX3-</b>	First channel data 3 output (negative)	DS0-33
	26	<b>FTX3+</b>	First channel data 3 output (positive)	DS0-33
	27 - 28	<b>GND</b>	Ground	PWR
	29	<b>STX0-</b>	Second channel data 0 output (negative)	DS0-33
	30	<b>STX0+</b>	Second channel data 0 output (positive)	DS0-33
	31	<b>STX1-</b>	Second channel data 1 output (negative)	DS0-33
	32	<b>STX1+</b>	Second channel data 1 output (positive)	DS0-33
	33	<b>STX2-</b>	Second channel data 2 output (negative)	DS0-33
	34	<b>STX2+</b>	Second channel data 2 output (positive)	DS0-33
	35	<b>STXC-</b>	Second channel clock output (negative)	DS0-33
	36	<b>STXC+</b>	Second channel clock output (positive)	DS0-33
	37	<b>STX3-</b>	Second channel data 3 output (negative)	DS0-33
	38	<b>STX3+</b>	Second channel data 3 output (positive)	DS0-33
	39 - 40	<b>GND</b>	Ground	PWR

---

**Note:** 1) To protect the external power lines of peripheral devices make sure that

- the wires have the right diameter to withstand the maximum available current.
- to enclosure of the peripheral device fulfills the fire-protecting conditions of IEC/EN 60950.

---

---

**Warning:** Check jumper J1801 (Panel Power) for correct settings for your panel – not doing so might cause permanent damage to your panel.

---

### 5.3 Connecting a Flat Panel

- 1 Check if you have the correct panel cable. Inspect the cable for damages. Disconnect the power from your system.
- 2 Check jumper J1801 for correct panel voltage (**Pos. 1-2 = +3.3V 2-3 = +5V**).
- 3 Connect an external power supply for the correct backlight voltage (except the power supply complies with the backlight voltage).
- 4 Connect the cable to the flat panel connector J1800 on the KTAM3874/pITX and connect the other end to your display.
- 5 Switch on the power supply and activate/save the desired settings with help of the U-Boot bootloader (for further details see the 'Software Guide' chapter 'U-Boot Setup'). Switch off the power supply.
- 6 Switch on the power supply. If you only see a blank screen contact your distributor for technical support.

### 5.4 Flat Panel Power Jumper

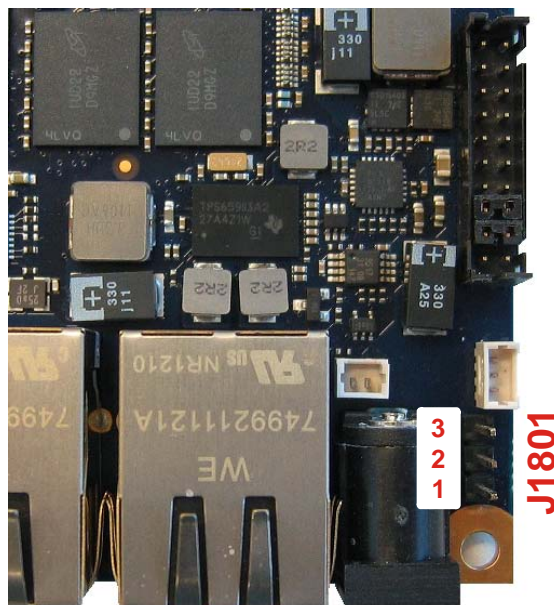

## 5.5 Backlight

Backlight is available through the connector J1800. The backlight voltage can be supplied from the on-board +5V voltage if you set one or two short circuit jumper on connector J2100. For backlight voltages differing from +5V use pin 9 and/or 11 on connector J2100 to supply the backlight (pins 7 and 8 represent the associated ground, identical with board ground).

With a GPIO line (GP3[14]) you can switch the brightness signal between an analog (0 - 5.0V) and a PWM signal.

### 5.5.1 Power Connector Backlight Pins

The following table is an extract of the J2100 connector overview. For further details about pin 1 see chapter 'Default Power Configuration'.

Pin	Signal	Description	Type
9	VDD <sup>1)</sup>	External backlight voltage input	PWR IN
10	VCC5 <sup>1)</sup>	Onboard power +5V	PWR
11	VDD <sup>1)</sup>	External backlight voltage input	PWR IN
12	VCC5 <sup>1)</sup>	Onboard power +5V	PWR
7	GND	Backlight ground	PWR
8	GND	Backlight ground	PWR

**Onboard +5V  
backlight voltage**  
(with short  
circuit jumper)

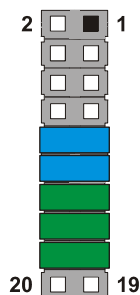

■ System  
■ Backlight

OR

**External Backlight  
Power Supply**

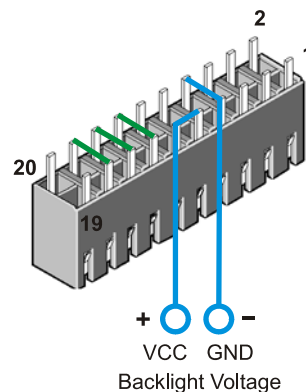

Top view

#### CAUTION!

If you use an external backlight power supply do not forget the three system links (pin 13 to 18) otherwise the board does not start.

### 5.5.2 LVDS Connector Backlight Pins

The following table is an extract of the J1800 connector overview.

Pin	Signal	Description	Type
1 - 5	<b>VDD</b> <sup>1)</sup>	Normal backlight voltage	PWR
6 and 8	<b>GND</b>	Ground	PWR

---

**Note:** 1) *To protect the external power lines of peripheral devices make sure that*

- *the wires have the right diameter to withstand the maximum available current.*
- *to enclosure of the peripheral device fulfills the fire-protecting conditions of IEC/EN 60950.*

---

### 5.5.3 External Backlight Voltage Parameter

Parameter	Min.	Typ.	Max.	Units
Backlight voltage	+5.0	+12.0	+15.0	V
Continuous current fixed power +5V			tbd.	A
Continuous current per pin on connector J2100			0.5	A

## 6 USB Interface

The USB interface comes with four USB ports which follow the EHCI specification (USB 2.0 compliant). A USB hub device with four additional interfaces enlarge one port of the SoC. You can expand the amount of USB connections by adding external hubs.

### 6.1 Standard Connector

Two USB ports are available through the standard USB connector J1700 (8 pins).

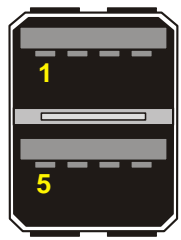
Header	Pin	Signal	Description	Type
	1	VCC5 <sup>1)</sup>	Power +5V	PWR
	2	USB0-	USB port 0 (negative)	DSIO-33
	3	USB0+	USB port 0 (positive)	DSIO-33
	4	GND	Ground	PWR
	5	VCC5 <sup>1)</sup>	Power +5V	PWR
	6	USB1-	USB port 1 (negative)	DSIO-33
	7	USB1+	USB port 1 (positive)	DSIO-33
	8	GND	Ground	PWR

### 6.2 Extension Connectors

The other USB ports are available through the extension connectors J1701 (4 pins) and J1702 (5 pins). If you want a standard USB interface connector an adapter cable is required (4 pins, KAB-USB-2, part number 96054-0000-00-2).

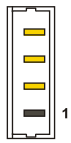
Header	Pin	Signal	Description	Type
	1	GND	Ground	PWR
	2	USBn+	USB port n (positive)	DSIO-33
	3	USBn-	USB port n (negative)	DSIO-33
	4	VCC5 <sup>1)</sup>	Power +5V	PWR

**Important:** The connector J1702 provides the USB Client (OTG) functionality. For normal usage you can also apply the 4 pin cable KAB-USB-2.

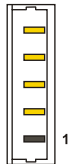
Header	Pin	Signal	Description	Type
	1	GND	Ground	PWR
	2	USBn+	USB port n (positive)	DSIO-33
	3	USBn-	USB port n (negative)	DSIO-33
	4	VCC5 <sup>1)</sup>	Power +5V	PWR
	5	ID	Host / slave detection (grounded or open)	I

---

**Note:** 1) *To protect the external power lines of peripheral devices make sure that*

- *the wires have the right diameter to withstand the maximum available current.*
- *to enclosure of the peripheral device fulfills the fire-protecting conditions of IEC/EN 60950.*

---

### 6.3 Limitations

The contacts for USB devices are protected and suitable to supply USB devices with a maximum input current of 500mA. Do not supply external USB devices with higher power dissipation through these pins.

## 7 LAN Interface

The KTAM3874/pITX uses both onchip Gigabit Ethernet controllers but the Physical Layer Transceivers only support 10/100 Base-T interfaces. The controller auto-negotiates the management of a 10/100 Mbps connection. Additionally you can boot up the board via a network connection from a PXE server. Following the connector assignment:

<b>J1600</b>	➔	<b>Ethernet MAC 0</b>
<b>J1601</b>	➔	<b>Ethernet MAC 1</b>

### 7.1 Connectors

Both interfaces are available through the standard RJ45 connectors J1600 and J1601 (8 pins).

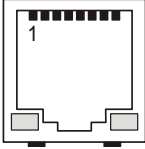
Header	Pin	Signal	Description	Type
	1	<b>TXD+</b>	10/100 transmit (positive)	DSO
	2	<b>TXD-</b>	10/100 transmit (negative)	DSO
	3	<b>RXD+</b>	10/100 receive (positive)	DSI
	4	<b>GND</b>	Ground (shield)	PWR
	5	<b>GND</b>	Ground (shield)	PWR
	6	<b>RXD-</b>	10/100 receive (negative)	DSI
	7	<b>GND</b>	Ground (shield)	PWR
	8	<b>GND</b>	Ground (shield)	PWR

## 8 Serial-ATA® Interface

Only one S-ATA® 2.0 port is available. Serial-ATA® connections boost the data rate theoretically up to 300 MB/sec. In addition it changes the parallel interface requiring 40 separate wires to a serial interface requiring only 6 wires. The controller supports the Advanced Host Controller Interface (AHCI).

 If you use a mini S-ATA® card on connector J900 the hardware automatically switches from the standard connector to the card socket.

### 8.1 Connector

The S-ATA® interface is available through the standard L-type connector J903 (7 pins).

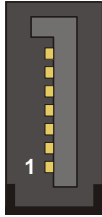
Header	Pin	Signal	Description	Type
	1	<b>GND</b>	Ground	PWR
	2	<b>TX+</b>	Transmit (positive)	DSO
	3	<b>TX-</b>	Transmit (negative)	DSO
	4	<b>GND</b>	Ground	PWR
	5	<b>RX-</b>	Receive (negative)	DSI
	6	<b>RX+</b>	Receive (positive)	DSI
	7	<b>GND</b>	Ground	PWR



## 9 CAN Interface

The board supports two Controller Area Network (CAN) interfaces with message-based protocol, designed specifically for automotive applications. This fieldbus represents a multi-master broadcast serial bus based on protocol rev. 2.0 part A, B. Bit rates up to 1 Mbps are possible with a maximum of 64 message objects. Two SN65HVD233 CAN transceivers realize the interface to the fieldbus. Following the connector assignment:

**J1301**      ➔      **CAN0**  
**J1302**      ➔      **CAN1**

### ATTENTION

In general no termination resistors with a value of  $60\Omega$  are equipped. For special requirements please contact your local distributor or [sbc-support@kontron.com](mailto:sbc-support@kontron.com).

### 9.1 Connectors

The CAN interfaces are available through the connectors J1301 and J1302 (3 pins).

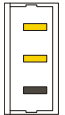
Header	Pin	Signal	Description	Type
	1	<b>CANL</b>	CAN interface n (negative)	DSIO-33
	2	<b>CANH</b>	CAN interface n (positive)	DSIO-33
	3	<b>GND</b>	Ground	PWR

## 10 Serial Interface

Three serial ports provide asynchronous serial communication with RS-232 interfaces. They are 16C750 UART compatible and support 64 byte FIFO buffers for transfer rates up to 12 Mbps. Following the connector assignment:

<b>J1304</b>	➔	<b>UART0</b>
<b>J1303</b>	➔	<b>UART3</b>
<b>J1300</b>	➔	<b>UART5</b>

### 10.1 Maximum Transfer Rates

Port	RS-232	RS-422	RS-485
UART0	1000 kbps	----	----
UART3	1000 kbps	----	----
UART5	400 kbps	12 Mbps	12 Mbps

### 10.2 Connectors

Two serial ports are available through the connectors J1300 and J1303 (5 pins)

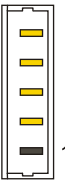
Header	Pin	Signal	Description	Type
	1	<b>TXD</b>	Transmit serial data	O
	2	<b>RXD</b>	Receive serial data	I
	3	<b>RTS#</b>	Request to send	O
	4	<b>CTS#</b>	Clear to send	I
	5	<b>GND</b>	Ground	PWR

and the third port through the connector J1304 (3 pins).

Header	Pin	Signal	Description	Type
	1	<b>TXD</b>	Transmit serial data	O
	2	<b>RXD</b>	Receive serial data	I
	3	<b>GND</b>	Ground	PWR

### 10.3 RS422/RS485 Interface

UART5 allows the switching between RS-232, RS-422 and RS-485. The differential signaling interface modifies the pin assingment of J1300 (5 pins) as follows:

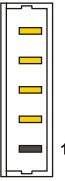
Header	Pin	Signal	Description	Type
	1	<b>TXD-</b>	Transmit data (negative)	DSO
	2	<b>RXD-</b>	Receive data (negative)	DSI
	3	<b>TXD+</b>	Transmit data (positive)	DSO
	4	<b>RXD+</b>	Receive data (positive)	DSI
	5	<b>GND</b>	Ground	PWR

#### ATTENTION

The board placement of RS-422/-485 termination resistors is not supported.

### 10.4 UART5 Configuration

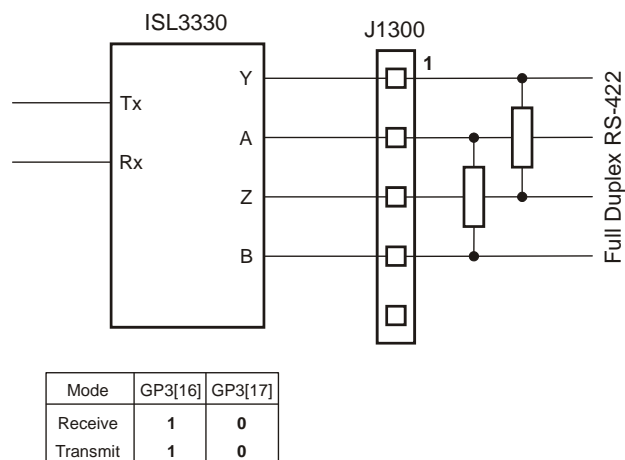
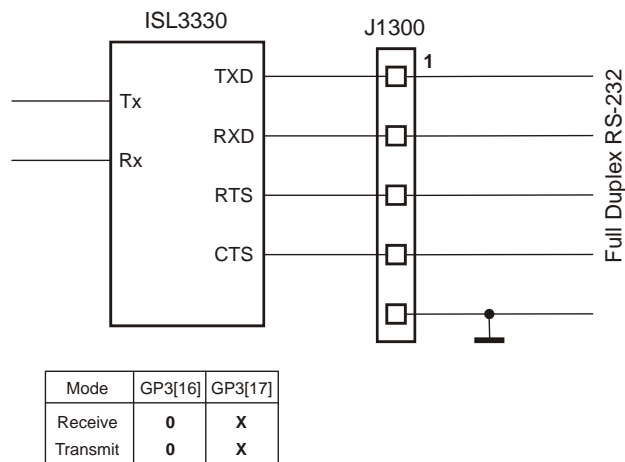

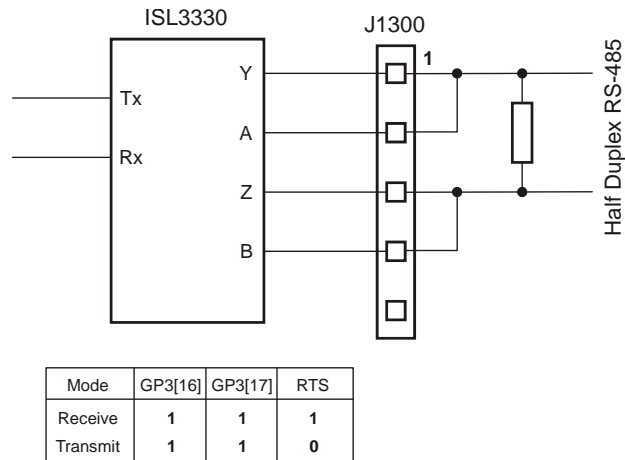

## 10.5 Serial Console

Most operating systems have a defined serial console. The KTAM3874/pITX board uses the first serial port (**UART0**) on connector J1304 for this purpose. The serial port is assigned to the environment variables **stdin**, **stdout** and **stderr**. If you use U-Boot as bootloader you can interact with U-Boot via a standard terminal program on a desktop computer. The following overview shows the default serial settings:

- Baudrate            115 kBaud
- Data bits            8
- Stop bits            1
- Parity                No

For development purposes it can be useful to download U-Boot via the serial interface. This feature is enabled if you set a jumper on pin header J1101. For further information see the Software Guide chapter 'Bootloader Download'.

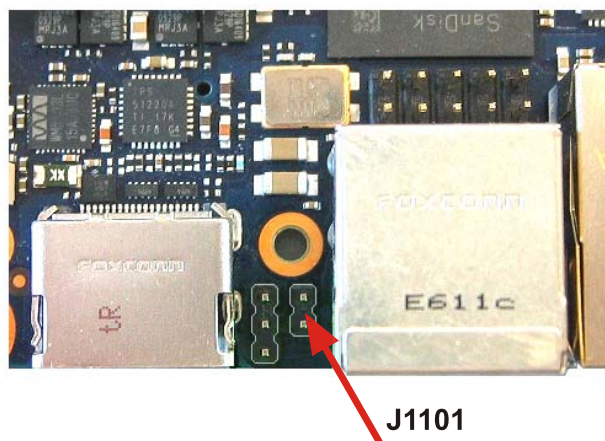

## 11 Audio Interface

The SoC supports an Inter-IC Sound (I<sup>2</sup>S) codec with 24 bit resolution and 96 kHz sample rate (the maximum rate of 96 kHz only unidirectional). The analogue-to-digital part of the codec uses 24 bit, 128x oversampled sigma-delta ADCs. The digital-to-analogue part contains two 24 bit sigma-delta DACs. The interface includes LINE OUT, LINE IN and MICROPHONE IN. From the six SoC audio serial ports the third port is used (McASP 2).

### 11.1 Audio Hardware Features

Parameter	Values	Units
Output resolution (LINE OUT)	16/20/24	bit
Output sample rate (LINE OUT)	44.1/48/96	kHz
Output signal-to-noise ratio (LINE OUT)	96	dB
Input resolution (LINE IN)	16/20/24	bit
Input sample rate (LINE IN)	44.1/48/96	kHz
Input signal-to-noise ratio (LINE IN)	92	dB

### 11.2 Analog Connector

The analog audio interface uses the connector J800 (6 pins). A prototype adapter cable (open ended) is deliverable (KAB-SOUND-CMP-2, part number 96063-0000-00-1).

Header	Pin	Signal	Description	Type
	1	<b>LINE_IN_L</b>	Line input left	AI
	2	<b>MIC_IN</b>	Microphone input	AI
	3	<b>LINE_IN_R</b>	Line input right	AI
	4	<b>LINE_OUT_L</b>	Line output left	A0
	5	<b>GND</b>	Ground	PWR
	6	<b>LINE_OUT_R</b>	Line output right	A0

### 11.3 Speaker Connector

The audio codec also supports a speaker driver interface. With both speaker drivers it is possible to realize a passive stereo loudspeaker system. The drivers have a thermal shutdown feature. If the junction temperature exceeds approximately 150°C then the output will be disabled. The speaker interface is available through the connector J801 (4 pins).

Header	Pin	Signal	Description	Type
	1	<b>SPK_R#</b>	Speaker right (negative)	A0
	2	<b>SPK_R</b>	Speaker right (positive)	A0
	3	<b>SPK_L#</b>	Speaker left (negative)	A0
	4	<b>SPK_L</b>	Speaker left (positive)	A0

### 11.3.1 Speaker Hardware Features

Parameter	Values	Units
Maximal output power	1 @ 8Ω	W
Output signal-to-noise ratio	97	db
Speaker mode	Class D	

## 12 Secure Digital and Multimedia Card

The SD/MMC interface can be divided into two parts: one microSD™ card socket and one onboard e.MMC device. The microSD™ card controller supports the SD specification revision 2.0 (implies the SDSC and SDHC families) and the MMC specification revision 4.3. The data bus width accounts four bits, the transfer rate can be up to 48 MHz. The second part includes a 4 GByte Embeded Flash Drive (EFD) with an industry standard e.MMC interface (8 bit data width). Following the controller assignment:

**microSD** → **MMC/SD/SDIO 1**  
**e.MMC Flash** → **MMC/SD/SDIO 2**

### 12.1 Connector

The microSD™ card socket is named J1400 (8 pins).

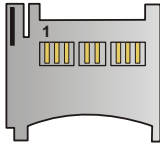
Header	Pin	Signal	Description	Type
	1	<b>DATA2</b>	Data bit 2	IO-33
	2	<b>CD / DATA3</b>	Card detect / Data bit 3	IO-33
	3	<b>CMD</b>	Command line	IO-33
	4	<b>VCC3</b> <sup>1)</sup>	Power +3.3V	PWR
	5	<b>CLK</b>	Clock	O-33
	6	<b>GND</b>	Ground	PWR
	7	<b>DATA0</b>	Data bit 0	IO-33
	8	<b>DATA1</b>	Data bit 1	IO-33

---

**Note:** 1) To protect the external power lines of peripheral devices make sure that

- the wires have the right diameter to withstand the maximum available current.
- to enclosure of the peripheral device fulfills the fire-protecting conditions of IEC/EN 60950.

---

## 13 PCI Express® Interface

TI's® Sitara™ supports the PCI Express® specification 2.0 with 5 GT/s (GigaTransfers/s - identical with Gigabits/s by one lane). One port with one lane is provided for free usage. KONTRON Technology A/S cannot guarantee that all available cards on the market function smoothly.

### 13.1 Connector

The mini PCI Express® port is available through the connector J900 (52 pins).

Header	Pin	Signal	Description	Type	Pin	Signal	Description	Type
	1	N.C.	Not connected	NC	2	VCC3 <sup>1)</sup>	Power +3.3V	PWR
	3	N.C.	Not connected	NC	4	GND	Ground	PWR
	5	N.C.	Not connected	NC	6	VCC1 <sup>1)</sup>	Power +1.5V	PWR
	7	N.C.	Not connected	NC	8	USIM_VCC	USIM power	PWR
	9	GND	Ground	PWR	10	USIM_IO	USIM data	IO
	11	PE_CLK-	PCIe® clock (neg.)	DSO	12	USIM_CLK	USIM clock	0
	13	PE_CLK+	PCIe® clock (pos.)	DSO	14	USIM_RST	USIM reset	0
	15	GND	Ground	PWR	16	USIM_VPP	USIM progr. volt.	PWR
	17	USIM_USB-	USIM USB (neg.)	DSIO	18	GND	Ground	PWR
	19	USIM_USB+	USIM USB (pos.)	DSIO	20	W_DISABLE#	Wireless disable	0-33
	21	GND	Ground	PWR	22	PE_RST#	PCIe® reset	0-33
	23	PE_RX-	PCIe® receive (neg.)	DSI	24	VCC3 <sup>1)</sup>	Power +3.3V	PWR
	25	PE_RX+	PCIe® receive (pos.)	DSI	26	GND	Ground	PWR
	27	GND	Ground	PWR	28	VCC1 <sup>1)</sup>	Power +1.5V	PWR
	29	GND	Ground	PWR	30	N.C.	Not connected	NC
	31	PE_TX-	PCIe® transmit (neg.)	DSO	32	N.C.	Not connected	NC
	33	PE_TX+	PCIe® transmit (pos.)	DSO	34	GND	Ground	PWR
	35	GND	Ground	PWR	36	USB-	USB port (neg.)	DSIO-33
	37	GND	Ground	PWR	38	USB+	USB port (pos.)	DSIO-33
	39	VCC3 <sup>1)</sup>	Power +3.3V	PWR	40	GND	Ground	PWR
	41	VCC3 <sup>1)</sup>	Power +3.3V	PWR	42	N.C.	Not connected	NC
	43	GND	Ground	PWR	44	N.C.	Not connected	NC
	45	N.C.	Not connected	NC	46	N.C.	Not connected	NC
	47	N.C.	Not connected	NC	48	VCC1 <sup>1)</sup>	Power +1.5V	PWR
	49	N.C.	Not connected	NC	50	GND	Ground	PWR
	51	SEL_SATA#	S-ATA® identification	I-18	52	VCC3 <sup>1)</sup>	Power +3.3V	PWR



For USB modem functionality an additional SIM card socket is available on connector J902 (8 pins).

Header	Pin	Signal	Description	Type
	1	<b>USIM_VCC</b> <sup>1)</sup>	USIM power	PWR
	2	<b>USIM_RST</b>	USIM reset	I
	3	<b>USIM_CLK</b>	USIM clock	I
	4	<b>USIM_USB+</b>	USIM USB (positive)	DSIO
	5	<b>GND</b>	Ground	PWR
	6	<b>USIM_VPP</b> <sup>1)</sup>	USIM progr. voltage	PWR
	7	<b>USIM_IO</b>	USIM data	IO
	8	<b>USIM_USB-</b>	USIM USB (negative)	DSIO

---

**Note:** 1) To protect the external power lines of peripheral devices make sure that

- the wires have the right diameter to withstand the maximum available current.
- to enclosure of the peripheral device fulfills the fire-protecting conditions of IEC/EN 60950.

---

## 14 Digital I/O Interface

The digital I/O interface is a subset of a multifunction part from TI's® Sitara™ SoC. Some of the I/O pins have additional functionalities which can be changed by software.

### 14.1 Multifunction Overview

The following table informs about the dependencies.

I/O Pin	TI® Label	Second Function	Connector
GPI00	GP0[10]	-----	J2105
GPI01	GP0[11]	-----	J2105
GPI02	GP0[12]	-----	J2105
GPI03	GP0[13]	-----	J2105
GPI04	GP0[14]	SPI™ fourth controller chip select (SPI3 SCS0)	J2105
GPI05	GP0[15]	SPI™ fourth controller clock (SPI3 SCLK)	J2105
GPI06	GP0[16]	SPI™ fourth controller data 1 (SPI3 D1)	J2105
GPI07	GP0[17]	SPI™ fourth controller data 0 (SPI3 D0)	J2105
GPI08	GP0[18]	-----	J2105
GPI09	GP0[19]	-----	J2105
GPI010	GP0[20]	-----	J2105
GPI011	GP0[21]	-----	J2105
GPI012	GP0[22]	UART4 RXD	J2105
GPI013	GP0[23]	UART4 TXD	J2105
GPI014	GP0[24]	UART4 CTS	J2105
GPI015	GP0[25]	UART4 RTS	J2105
GPI016	GP0[26]	UART2 RXD	J2105
GPI017	GP0[27]	UART2 TXD	J2105
GPI018	GP0[28]	UART2 CTS	J2105
GPI026	GP2[02]	UART2 RTS	J2105
GPI033	GP2[16]	-----	J2105
GPI034	GP2[17]	-----	J2105
GPI035	GP2[18]	-----	J2105
GPI036	GP2[19]	-----	J2105
GPI037	GP2[20]	-----	J2105
GPI019	GP1[11]	-----	J2104
GPI020	GP1[12]	-----	J2104
GPI021	GP1[27]	Timer 4 input/output (TIM4 IO)	J2104
GPI022	GP1[28]	Timer 5 input/output (TIM5 IO)	J2104
GPI023	GP1[29]	Timer 6 input/output (TIM6 IO)	J2104
GPI024	GP1[30]	Timer 7 input/output (TIM7 IO)	J2104
GPI025	GP2[00]	-----	J2104
GPI027	GP2[07]	-----	J2104

GPI028	GP2[08]	-----	J2104
GPI029	GP2[09]	-----	J2104
GPI030	GP2[10]	-----	J2104
GPI031	GP2[11]	-----	J2104
GPI032	GP2[12]	-----	J2104

## 14.2 Electrical Specifications

### Digital Inputs

Parameter	Min.	Typ.	Max.	Units
Input LOW voltage			+0.8	V
Input HIGH voltage	+2.0	3.3	+3.5	V
Input rate (Linux, <u>sysfs</u> )			300	kHz

### Digital Outputs

Parameter	Min.	Typ.	Max.	Units
Output LOW voltage			+0.4	V
Output HIGH voltage	+2.4		+3.3	V
Output LOW/HIGH current			6	mA
Switching rate (Linux, <u>sysfs</u> )			300	kHz

## 14.3 Connector 1

Some digital I/O signals are available through the connector J2104 (20 pins).

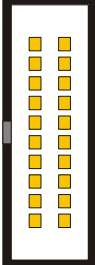
Header	Pin	Signal	Description	Type
	1	VCC3 <sup>1)</sup>	Power +3.3V	PWR
	2	VCC3 <sup>1)</sup>	Power +3.3V	PWR
	3	SDA	I <sup>2</sup> C™ 3rd controller data (I2C2)	IO-33
	4	SCL	I <sup>2</sup> C™ 3rd controller clock (I2C2)	IO-33
	5	GPI021	I/O GP1[27] or TIM4 IO	IO-33
	6	GPI022	I/O GP1[28] or TIM5 IO	IO-33
	7	GPI023	I/O GP1[29] or TIM6 IO	IO-33
	8	GPI024	I/O GP1[30] or TIM7 IO	IO-33
	9	GPI019	I/O GP1[11]	IO-33
	10	GPI020	I/O GP1[12]	IO-33
	11	GPI027	I/O GP2[07]	IO-33
	12	GPI028	I/O GP2[08]	IO-33
	13	GPI029	I/O GP2[09]	IO-33
	14	GPI030	I/O GP2[10]	IO-33
	15	GPI031	I/O GP2[11]	IO-33
	16	GPI032	I/O GP2[12]	IO-33
	17	RSVD	Reserved	---
	18	GPI025	I/O GP2[00]	IO-33
	19	GND	Ground	PWR
	20	GND	Ground	PWR

### CAUTION!

Do not use signal voltages above 3.3V. All I/O signals are unprotected against overvoltage.

**Note:** 1) To protect the external power lines of peripheral devices make sure that

- the wires have the right diameter to withstand the maximum available current.
- to enclosure of the peripheral device fulfills the fire-protecting conditions of IEC/EN 60950.

## 14.4 Connector 2

Most of digital I/O pins are linked with connector J2105 (40 pins). A prototype cable with open ends is available (part number 821515).

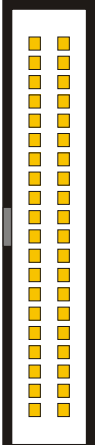
Header	Pin	Signal	Description	Type
	1 - 2	VCC3 <sup>1)</sup>	Power +3.3V	PWR
	3	SDA	I <sup>2</sup> C™ 3rd controller data (I2C2)	IO-33
	4	SCL	I <sup>2</sup> C™ 3rd controller clock (I2C2)	IO-33
	5	SCS0	SPI™ 3rd controller chip select (SPI2)	IO-33
	6	SCLK	SPI™ 3rd controller clock (SPI2)	IO-33
	7	D0	SPI™ 3rd controller data 0 (SPI2)	IO-33
	8	D1	SPI™ 3rd controller data 1 (SPI2)	IO-33
	9 - 10	GND	Ground	PWR
	11	GPI015	I/O GPO[25] or UART4 RTS	IO-33
	12	GPI014	I/O GPO[24] or UART4 CTS	IO-33
	13	GPI013	I/O GPO[23] or UART4 TXD	IO-33
	14	GPI012	I/O GPO[22] or UART4 RXD	IO-33
	15	GPI011	I/O GPO[21]	IO-33
	16	GPI010	I/O GPO[20]	IO-33
	17	GPI09	I/O GPO[19]	IO-33
	18	GPI08	I/O GPO[18]	IO-33
	19	GPI00	I/O GPO[10]	IO-33
	20	GPI01	I/O GPO[11]	IO-33
	21	GPI02	I/O GPO[12]	IO-33
	22	GPI03	I/O GPO[13]	IO-33
	23	GPI04	I/O GPO[14] or SPI3 SCS0	IO-33
	24	GPI05	I/O GPO[15] or SPI3 SCLK	IO-33
	25	GPI06	I/O GPO[16] or SPI3 D1	IO-33
	26	GPI07	I/O GPO[17] or SPI3 D0	IO-33
	27 - 28	GND	Ground	PWR
	29	GPI016	I/O GPO[26] or UART2 RXD	IO-33
	30	GPI017	I/O GPO[27] or UART2 TXD	IO-33
	31	GPI018	I/O GPO[28] or UART2 CTS	IO-33
	32	GPI026	I/O GP2[02] or UART2 RTS	IO-33
	33	GPI035	I/O GP2[18]	IO-33
	34	GPI036	I/O GP2[19]	IO-33
	35	GPI037	I/O GP2[20]	IO-33
	36	GPI033	I/O GP2[16]	IO-33
	37	RSVD	Reserved	---
	38	GPI034	I/O GP2[17]	IO-33
	39 - 40	VCC3 <sup>1)</sup>	Power +3.3V	PWR

**CAUTION!**

Do not use signal voltages above 3.3V. All I/O signals are unprotected against overvoltage.

- 
- Note:** 1) *To protect the external power lines of peripheral devices make sure that*
- *the wires have the right diameter to withstand the maximum available current.*
  - *to enclosure of the peripheral device fulfills the fire-protecting conditions of IEC/EN 60950.*
-

## 15 Power Supply

The KTAM3874/pITX SBC has a power input voltage range from +4.75V to +5.25V DC. All other voltages are generated onboard (e.g. +3.3V / +1.8V system voltage).

### 15.1 DC Power Connector

The power supply is injected through the connector J2101 (3 pins, DC power jacket 2.1mm).

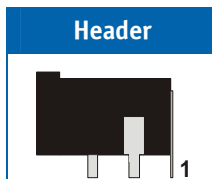
Header	Pin	Signal	Description
	1	<b>VCC_IN</b> <sup>1)</sup>	DC power supply input +5V
	2	<b>GND</b>	Ground
	3	<b>GND</b>	Ground

### 15.2 External Power Connector

The connector J2100 (20 pins) can also be used to power the board instead of the round power jacket. In any case the green sections should be connected together (pin 13 with pin 14, pin 15 with pin 16 and pin 17 with pin 18).

Header	Pin	Signal	Description	Type
	1	<b>GND</b>	Ground	PWR
	2	<b>GND</b>	Ground	PWR
	3	<b>I2C_SDA</b>	I <sup>2</sup> C™ data	IO-50
	4	<b>I2C_SCL</b>	I <sup>2</sup> C™ clock	IO-50
	5	<b>RSVD</b>	Reserved for future use	---
	6	<b>RSVD</b>	Reserved for future use	---
	7	<b>GND</b>	Ground	PWR
	8	<b>GND</b>	Ground	PWR
	9	<b>VDD</b> <sup>1)</sup>	External backlight voltage input	PWR IN
	10	<b>VCC5</b>	Onboard power +5V	PWR
	11	<b>VDD</b> <sup>1)</sup>	External backlight voltage input	PWR IN
	12	<b>VCC5</b>	Onboard power +5V	PWR
	13	<b>VCC_IN</b> <sup>1)</sup>	DC power supply input +5V	PWR IN
	14	<b>VCC5</b>	Onboard power +5V	PWR
	15	<b>VCC_IN</b> <sup>1)</sup>	DC power supply input +5V	PWR IN
	16	<b>VCC5</b>	Onboard power +5V	PWR
	17	<b>VCC_IN</b> <sup>1)</sup>	DC power supply input +5V	PWR IN
	18	<b>VCC5</b>	Onboard power +5V	PWR
	19	<b>RSVD</b>	Reserved for future use	---
	20	<b>RSVD</b>	Reserved for future use	---

**Warning:** Do not overload the onboard system voltage +3.3V resp. 1.8V (microSD™ card socket, digital I/O connector). The maximum current should not exceed 250mA.

**Note:** 1) To protect the external power lines of peripheral devices make sure that

- the wires have the right diameter to withstand the maximum available current.
- to enclosure of the peripheral device fulfills the fire-protecting conditions of IEC/EN 60950.

### 15.3 Default Power Configuration

In the delivery state the three short circuit jumpers are set (DC power jacket configuration). As far as possible all three pins should be used (each VCC\_IN and VCC) to minimize the current load per pin.

#### Top view

DC Power Jacket Configuration (short circuit jumper needed)      External Power Supply Configuration

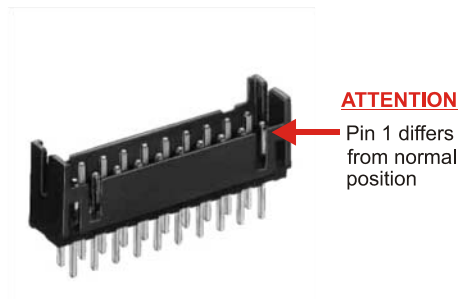
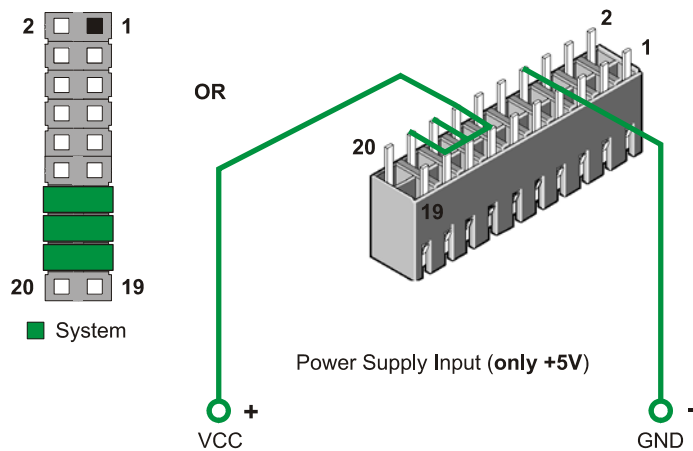

#### CAUTION!

If you use an external power supply do not use another voltage than +5V DC.



## 15.4 Power Front Panel Header

The power button and other power signals are available through the pin header J2102 (10 pins).

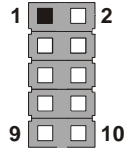
Header	Pin	Signal	Description	Type
	1	<b>RST_BTN+</b>	Reset button (positive)	I-33
	2	<b>PWR_BTN+</b>	Power button (positive)	I-33
	3	<b>RST_BTN-</b>	Reset button (negative) = GND	PWR
	4	<b>PWR_BTN-</b>	Power button (negative) = GND	PWR
	5	<b>POWER_LED1-</b>	Power LED1 (negative) = GND	---
	6	<b>POWER_LED2-</b>	Power LED2 (negative) = GND	---
	7	<b>POWER_LED1+</b>	Power LED1 (positive)	PWR
	8	<b>POWER_LED2+</b>	Power LED2 (positive)	PWR
	9	<b>GND</b>	Ground	PWR
	10	<b>GND</b>	Ground	PWR

### CAUTION!

If you apply a discrete logic circuit instead the standard buttons to control the reset respectively power button inputs then you should use open drain outputs without a resistor for the RESET and with a pullup resistor for the POWER button.

### 15.4.1 Power LEDs

The following picture illustrates the onboard wiring.

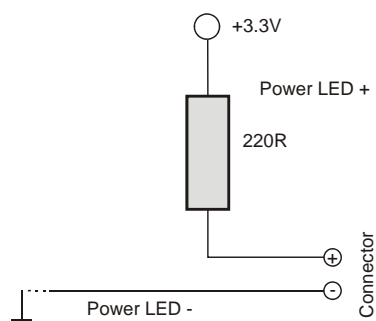

## 15.5 Onboard Status LED



Power LED

## 15.6 Real-Time Clock Battery Connector

An external battery is only needed if time and date should be saved when the board turns off. The battery interface uses the pin header J1900 (2 pins).

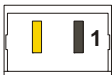
Header	Pin	Signal	Description	Type
	1	<b>VBAT3</b> <sup>1)</sup>	Battery input voltage +3V	PWR IN
	2	<b>GND</b>	Ground	PWR

**Note:** 1) To protect the external power lines of peripheral devices make sure that

- the wires have the right diameter to withstand the maximum available current.
- to enclosure of the peripheral device fulfills the fire-protecting conditions of IEC/EN 60950.

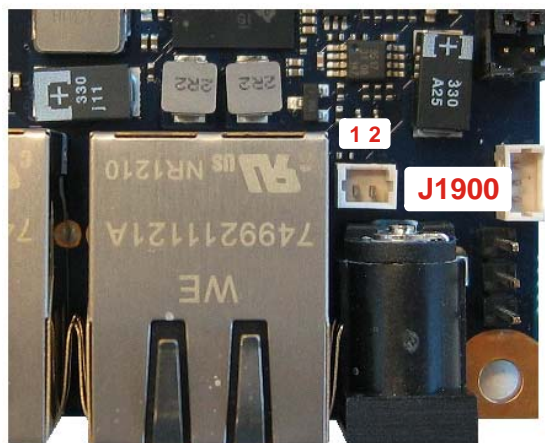

## 16 Boot Order

For the purpose of keeping as many options as possible two different boot orders are available:

**SPI → MMC → UART → EMAC** (default)

**MMC → SPI → UART → EMAC**

### Legend:

<b>SPI</b>	Onboard SPI flash
<b>MMC</b>	Only microSD™ card socket (not the e.MMC flash)
<b>UART</b>	Only onboard UART0 (serial console, J1304)
<b>EMAC</b>	Only Ethernet MAC 0 interface (J1600)

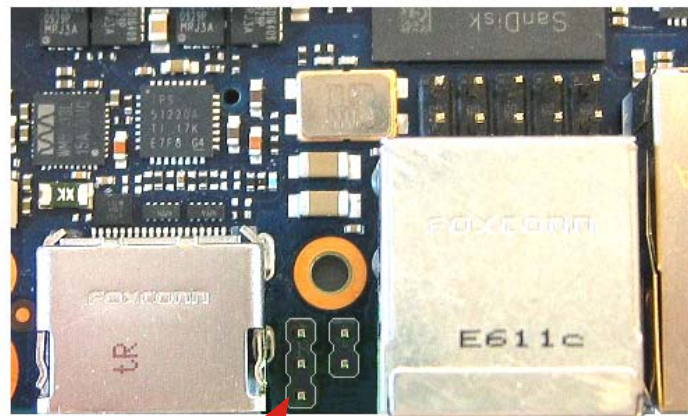

**J1100**



MMC / SPI / UART / EMAC



SPI / MMC / UART / EMAC

If you use the boot order 'MMC/SPI/UART/EMAC' you can bypass the Kontron bootloader in the SPI flash. This circumstance gives more flexibility for own solutions.

## Appendix A: System Resources

### A.1 Memory Area

See TI's® AM387x Sitara™ datasheet for memory mapping.

### A.2 I<sup>2</sup>C™ Bus

Only three I<sup>2</sup>C™ busses should be used (bus 0 internally reserved).

I <sup>2</sup> C™ bus	Device	Comment
1	HDMI® DDC Eeprom	
2	Disposable on I/O connectors J2104 and J2105	
3	LVDS DDC Eeprom	

# Appendix B: Mechanical Dimensions

## Top Side (with heat spreader)

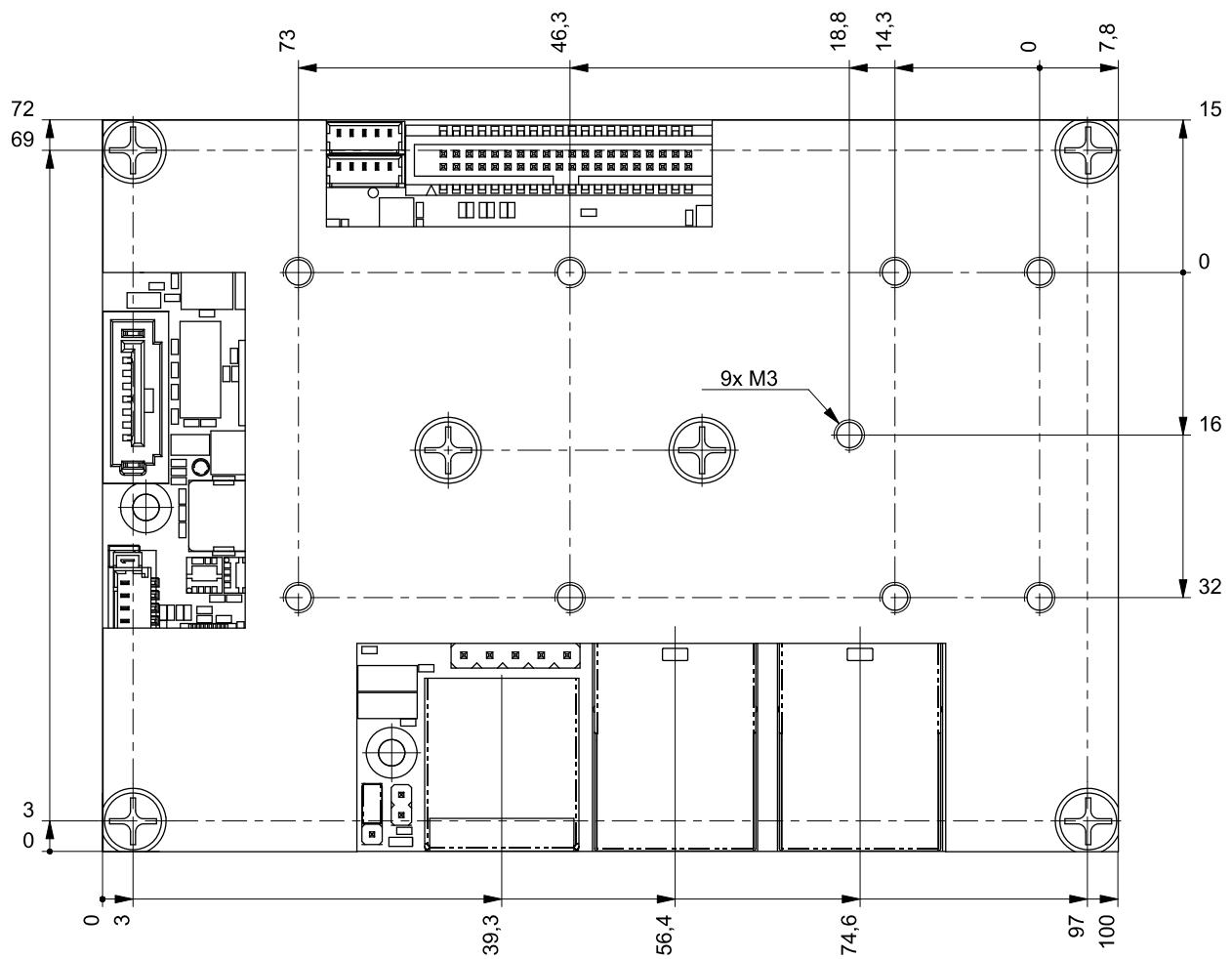
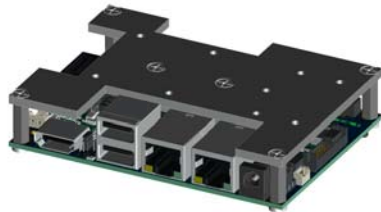

Bottom Side

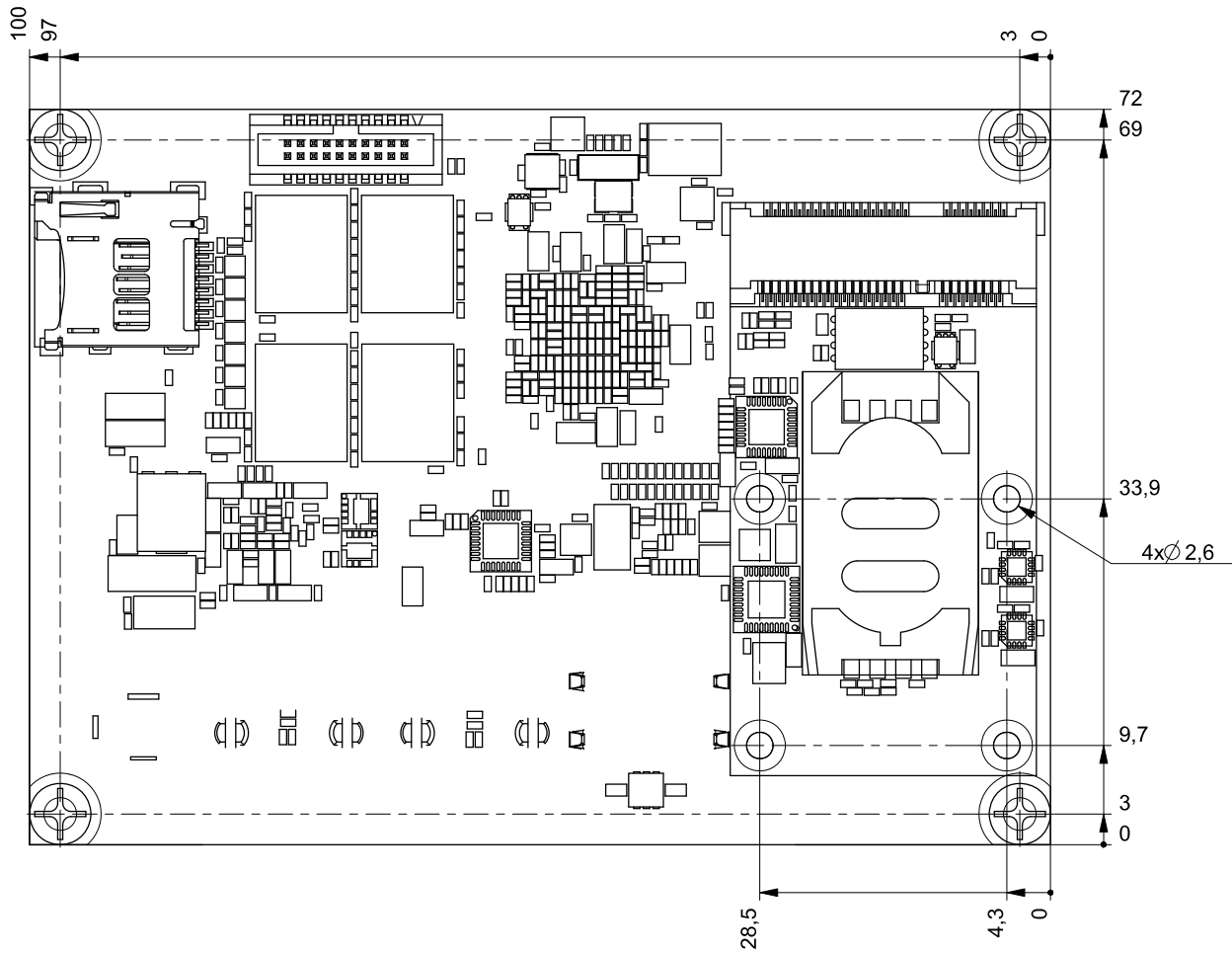

## Appendix C: Connector Overview

### C.1 Mating Connectors

The table notes mating connectors.

Identifier	Mating Connector	Comment
J800	1.25 mm 6 pin (MOLEX 51021-0600 or comp.)	Analog audio connector
J801	1.25 mm 4 pin (MOLEX 51021-0400 or comp.)	Speaker connector
J1300	1.25 mm 5 pin (MOLEX 51021-0500 or comp.)	UART5 connector
J1301	1.25 mm 3 pin (MOLEX 51021-0300 or comp.)	CAN0 connector
J1302	1.25 mm 3 pin (MOLEX 51021-0300 or comp.)	CAN1 connector
J1303	1.25 mm 5 pin (MOLEX 51021-0500 or comp.)	UART3 connector
J1304	1.25 mm 3 pin (MOLEX 51021-0300 or comp.)	UART0 connector
J1701	1.25 mm 4 pin (MOLEX 51021-0400 or comp.)	USB connector
J1702	1.25 mm 5 pin (MOLEX 51021-0500 or comp.)	USB client connector
J1800	1.27 mm 40 pin (SAMTEC FFSD-20-D-XX-01-N or comp.)	LVDS connector
J1900	1.25 mm 2 pin (MOLEX 51021-0200 or comp.)	Battery connector
J2100	2.0 mm 20 pin (HIROSE DF11-20DS-2C**)	External power connector
J2104	1.27 mm 20 pin (SAMTEC FFSD-10-D-XX-01-N or comp.)	GPI01 connector
J2105	1.27 mm 40 pin (SAMTEC FFSD-20-D-XX-01-N or comp.)	GPI02 connector

## C.2 Pinout Tables

Pin	HDMI® J901	LVDS J1800	PCIe® J900	GPIO 2 J2105
1	TMDS2+	VDD	N.C.	VCC3
2	GND	VDD	VCC3	VCC3
3	TMDS2-	VDD	N.C.	SDA
4	TMDS1+	VDD	GND	SCL
5	GND	VDD	N.C.	SCS0
6	TMDS1-	GND	VCC1	SCLK
7	TMDS0+	VCC5	N.C.	DO
8	GND	GND	USIM_VCC	D1
9	TMDS0-	VCC3/VCC5	GND	GND
10	TMDS_CLK+	VCC3/VCC5	USIM_IO	GND
11	GND	DDC_CLK	PE_CLK-	GPIO15
12	TMDS_CLK-	DDC_DATA	USIM_CLK	GPIO14
13	CEC	BKLTADJ	PE_CLK+	GPIO13
14	N.C.	VCCENA	USIM_RST	GPIO12
15	DDC_CLK	BKLTON	GND	GPIO11
16	DDC_DATA	GND	USIM_VPP	GPIO10
17	GND	FTX0-	USIM_USB-	GPIO9
18	VCC5	FTX0+	GND	GPIO8
19	TMDS_HPD	FTX1-	USIM_USB+	GPIO0
20		FTX1+	W_DISABLE#	GPIO1
21		FTX2-	GND	GPIO2
22		FTX2+	PE_RST#	GPIO3
23		FTXC-	PE_RX-	GPIO4
24		FTXC+	VCC3	GPIO5
25		FTX3-	PE_RX+	GPIO6
26		FTX3+	GND	GPIO7
27		GND	GND	GND
28		GND	VCC1	GND
29		STX0-	GND	GPIO16
30		STX0+	I2C_CLK	GPIO17
31		STX1-	PE_TX-	GPIO18
32		STX1+	I2C_DATA	GPIO26
33		STX2-	PE_TX+	GPIO35
34		STX2+	GND	GPIO36
35		STXC-	GND	GPIO37
36		STXC+	USB-	GPIO33
37		STX3-	GND	RSVD
38		STX3+	USB+	GPIO34
39		GND	VCC3	VCC3
40		GND	GND	VCC3
41			VCC3	
42			N.C.	
43			GND	
44			N.C.	
45			N.C.	
46			N.C.	
47			N.C.	
48			VCC1	
49			N.C.	
50			GND	
51			SEL_SATA#	
52			VCC3	



Pin	GPIO 1 J2104	External Power J2100	Power Front Header J2102
1	VCC3	GND	RST_BTN+
2	VCC3	GND	PWR_BTN+
3	SDA	I2C_SDA	RST_BTN-
4	SCL	I2C_SCL	PWR_BTN-
5	GPI021	RSVD	POWER_LED1-
6	GPI022	RSVD	POWER_LED2-
7	GPI023	GND	POWER_LED1+
8	GPI024	GND	POWER_LED2+
9	GPI019	VDD	GND
10	GPI020	VCC5	GND
11	GPI027	VDD	
12	GPI028	VCC5	
13	GPI029	VCC_IN	
14	GPI030	VCC5	
15	GPI031	VCC_IN	
16	GPI032	VCC5	
17	RSVD	VCC_IN	
18	GPI025	VCC5	
19	GND	RSVD	
20	GND	RSVD	

Pin	USB Standard J1700	USB Client J1702	USB Extension J1701
1	VCC5	GND	GND
2	USB0-	USBn+	USBn+
3	USB0+	USBn-	USBn-
4	GND	VCC5	VCC5
5	VCC5	ID	
6	USB1-		
7	USB1+		
8	GND		

Pin	LAN J1600/J1601	S-ATA <sup>®</sup> J903	microSD <sup>™</sup> Socket J1400
1	TXD+	GND	DATA2
2	TXD-	TX+	CD / DATA3
3	RXD+	TX-	CMD
4	GND	GND	VCC3
5	GND	RX-	CLK
6	RXD-	RX+	GND
7	GND	GND	DATA0
8	GND		DATA1

Pin	Audio J800	Speaker J801	CAN J1301/J1302
1	LINE_IN_L	SPK_R#	CANL
2	MIC_IN	SPK_R	CANH
3	LINE_IN_R	SPK_L#	GND
4	LINE_OUT_L	SPK_L	
5	GND		
6	LINE_OUT_R		

Pin	UART3 J1303	UART5 J1300	UART0 J1304
1	TXD	TXD / TXD-	TXD
2	RXD	RXD / RXD-	RXD
3	RTS#	RTS# / TXD+	GND
4	CTS#	CTS# / RXD+	
5	GND	GND	

## Appendix D: Reference Documents

KONTRON Technology A/S can't guarantee the availability of internet addresses.

Document	Internet Address
TI <sup>®</sup> AM3874 Datasheet and Reference Manual	<a href="http://www.ti.com/product/am3874">http://www.ti.com/product/am3874</a>
TI <sup>®</sup> E2E <sup>™</sup> Community	<a href="http://e2e.ti.com/support/dsp/davinci_digital_media_processors/f/716.aspx">http://e2e.ti.com/support/dsp/davinci_digital_media_processors/f/716.aspx</a>
Linux EZ Software Development Kit	<a href="http://www.ti.com/tool/linuxezsdk-sitara">http://www.ti.com/tool/linuxezsdk-sitara</a>
High Definition Multimedia Interface (HDMI <sup>®</sup> )	<a href="http://www.hdmi.org/manufacturer/specification.aspx">http://www.hdmi.org/manufacturer/specification.aspx</a>
Open LVDS Display Interface Standard Spec.	<a href="http://www.national.com/analog/displays/open_ldi">http://www.national.com/analog/displays/open_ldi</a>
IEEE 802.3 <sup>®</sup> Specification (Ethernet)	<a href="http://standards.ieee.org/getieee802">http://standards.ieee.org/getieee802</a>
Universal Serial Bus Specification (USB)	<a href="http://www.usb.org/developers/docs">http://www.usb.org/developers/docs</a>
SD <sup>™</sup> Specification (SD Card)	<a href="http://www.sdcard.org/developers/tech/sdio/sdio_spec">http://www.sdcard.org/developers/tech/sdio/sdio_spec</a>
High Speed Serialized AT Attachment (S-ATA)	<a href="http://www.sata-io.org/developers">http://www.sata-io.org/developers</a>
PCI Express <sup>®</sup> Base Specification (PCI Express <sup>®</sup> )	<a href="http://www.pcisig.com/specifications">http://www.pcisig.com/specifications</a>
CAN Bus Specification (CAN)	<a href="http://www.semiconductors.bosch.de/media/pdf/canliteratur/can2spec.pdf">http://www.semiconductors.bosch.de/media/pdf/canliteratur/can2spec.pdf</a>
CAN Bus Background Information (CAN)	<a href="http://www.canbus.us">http://www.canbus.us</a>

## Appendix E: Certifications



paconsult

### TEST REPORT No. 13-5252

**Test Specimen:** KTAM3874/pITX Boards

**Client:** Kontron Technology A/S  
Hamburger Straße 181  
D-22083 Hamburg

**Present Persons:**

---

**Purpose:**

In connection with a laboratory simulation three Boards –KTAM3874/pITX– should be tested to vibration- and shock strains. The tests were given by the client and are described in the IEC 60068-2-64 and 60068-2-27 standards.

---

**Summary:**

The qualification tests were performed successfully. During the tests the specified function of the boards was checked and could be demonstrated. The detailed analysis of the specimen will be performed by the client.

---

**Date of delivery:** 09<sup>th</sup> of July, 2013

**Testing Period:** 11<sup>th</sup> to 12<sup>th</sup> of July, 2013

**Pages:** 28

**Appendix:** 1

**Revision:** 0

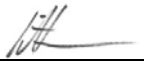
**Written:** Dipl.-Ing. J.Lüttmann  02<sup>nd</sup> of August 2013  
(Laboratory Test Engineer) Signature

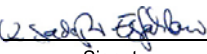
**Reviewed:** Dr.-Ing. K.Esfahlani  02<sup>nd</sup> of August 2013  
(Managing Director) Signature

## CERTIFICATE OF COMPLIANCE

**Certificate Number** 20130726-E194252  
**Report Reference** E194252-A27-UL  
**Issue Date** 2013-JULY-26

**Issued to:** KONTRON TECHNOLOGY A/S  
 DR NEERGAARDS VEJ 5D  
 2970 HOERSHOLM DENMARK



**This is to certify that representative samples of** COMPONENT - Information Technology Equipment Including Electrical Business Equipment Mother Board-KTAM3874/pITX

Have been investigated by UL in accordance with the Standard(s) indicated on this Certificate.

**Standard(s) for Safety:** UL 60950-1, Information Technology Equipment - Safety - Part 1: General Requirements  
 CSA C22.2 No. 60950-1-07, Information Technology Equipment - Safety - Part 1: General Requirements

**Additional Information:** See the UL Online Certifications Directory at [www.ul.com/database](http://www.ul.com/database) for additional information

Only those products bearing the UL Recognized Component Marks for the U.S. and Canada should be considered as being covered by UL's Recognition and Follow-Up Service and meeting the appropriate U.S. and Canadian requirements.

The UL Recognized Component Mark for the U.S. generally consists of the manufacturer's identification and catalog number, model number or other product designation as specified under "Marking" for the particular Recognition as published in the appropriate UL Directory. As a supplementary means of identifying products that have been produced under UL's Component Recognition Program, UL's Recognized Component Mark: , may be used in conjunction with the required Recognized Marks. The Recognized Component Mark is required when specified in the UL Directory preceding the recognitions or under "Markings" for the individual recognitions. The UL Recognized Component Mark for Canada consists of the UL Recognized Mark for Canada:  and the manufacturer's identification and catalog number, model number or other product designation as specified under "Marking" for the particular Recognition as published in the appropriate UL Directory.

Recognized components are incomplete in certain constructional features or restricted in performance capabilities and are intended for use as components of complete equipment submitted for investigation rather than for direct separate installation in the field. The final acceptance of the component is dependent upon its installation and use in complete equipment submitted to UL LLC.

Look for the UL Recognized Component Mark on the product.



William R. Carney, Director, North American Certification Programs  
 UL LLC

Any information and documentation involving UL Mark services are provided on behalf of UL LLC (UL) or any authorized licensee of UL. For questions, please contact a local UL Customer Service Representative at [www.ul.com/contactus](http://www.ul.com/contactus)



## » Kontron Quality Data «



### »KTAM3874/pITX Reliability Report

The following MTBF (Mean Time Before Failure) values were calculated using a combination of manufacturer's test data, if the data was available, and the Telcordia (Bellcore) issue 2 calculation for the remaining parts.

The Telcordia calculation used is "Method 1 Case 3" in a ground benign, controlled environment (GB,GC). This particular method takes into account varying temperature and stress data and the system is assumed to have not been burned in.

Figure 1 below shows MTBF de-rating for the E1 temperature range in an office or telecommunications environment. Other environmental stresses (extreme altitude, vibration, salt water exposure, etc) lower MTBF values.

»System MTBF(hours) = 220883 @ 40°C

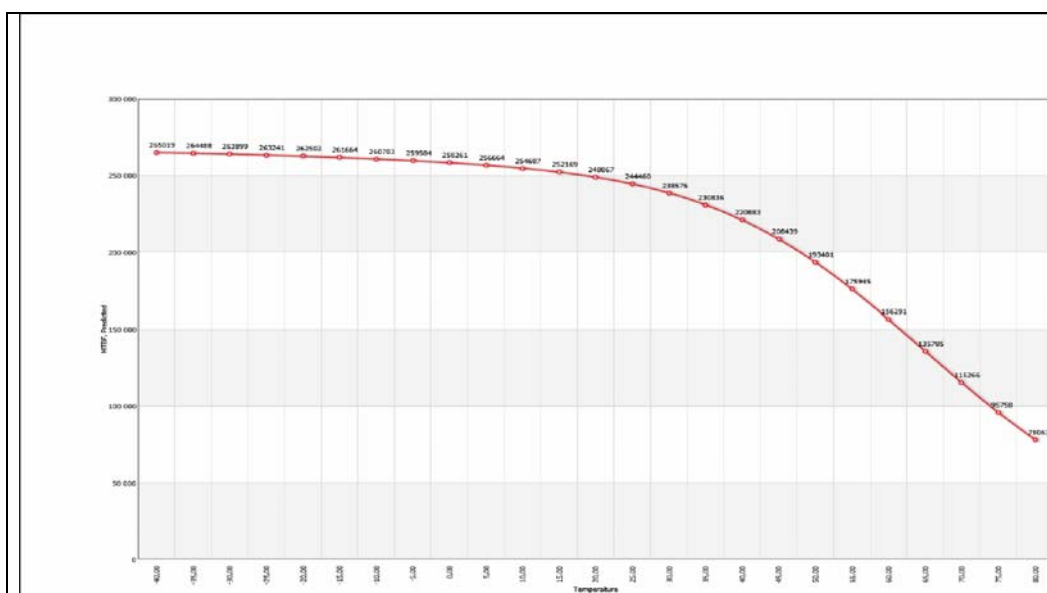

Figure 1. MTBF temperature de-rating.

*Fans usually shipped with Kontron Embedded Modules GmbH products have 50,000-hour typical operating life. The above estimates assume no fan, but a passive heat sinking arrangement. Estimated RTC battery life (as opposed to battery failures) is not accounted for in the above figure and needs to be considered for separately. Battery life depends on both temperature and operating conditions. When the Kontron unit has external power; the only battery drain is from leakage paths.*

All data is for information purposes only and not guaranteed for legal purposes. Subject to change without notice. Information in this datasheet has been carefully checked and is believed to be accurate; however, no responsibility is assumed for inaccuracies.

All rights reserved. DIMM-PC®, PISA®, ETX®, ETXexpress® and X-board® are trademarks or registered trademarks of Kontron Embedded Modules GmbH. Kontron is trademark or registered trademark of Kontron AG.

All other brand or product names are trademarks or registered trademarks or copyrights by their respective owners and are recognized.

Copyright © 2010 Kontron.

L4-0590 07/07/11

If it's embedded, it's Kontron.

## Appendix F: Document Revision History

Revision	Date	Author	Changes
S0051-D	09/16/13	M. Hüttmann	Replacing of power connector J2100 (other pinout) and new pictures in chapter 'Connector Locations'. Added chapter 'Mechanical Dimensions' and 'Certifications'
S0051-C	07/03/13	M. Hüttmann	Changed board overview and temperature range
S0051-B	06/11/13	M. Hüttmann	Clarification of Ethernet controller speed
S0051-A	05/07/13	M. Hüttmann	Added chapter 'Boot Order', a paragraph in 'Serial Console' and article numbers in chapter 'KTAM3874/pITX Overview'
S0051-0	03/27/13	M. Hüttmann	Created preliminary manual

### Corporate Offices

#### Europe, Middle East & Africa

Oskar-von-Miller-Str. 1  
85386 Eching/Munich  
Germany  
Tel.: +49 (0)8165/ 77 777  
Fax: +49 (0)8165/ 77 219  
[info@kontron.com](mailto:info@kontron.com)

#### North America

14118 Stowe Drive  
Poway, CA 92064-7147  
USA  
Tel.: +1 888 294 4558  
Fax: +1 858 677 0898  
[info@us.kontron.com](mailto:info@us.kontron.com)

#### Asia Pacific

17 Building, Block #1, ABP  
188 Southern West 4th Ring Road  
Beijing 100070, P.R.China  
Tel.: + 86 10 63751188  
Fax: + 86 10 83682438  
[info@kontron.cn](mailto:info@kontron.cn)

