

» User Guide «



Micro Client 3 104/121/150/170 Micro Client 3W 156

User's Guide (Version 1.0)
1055-8487

This page is intentionally left blank.

1. Table of Contents

1. Table of Contents	1
1.1. Table of Figures	3
1.2. Tables	4
2. Introduction	5
2.1. Symbols used in this User’s Guide	6
3. Important Instructions	7
3.1. Note on the Warranty	7
3.2. Exclusion of Accident Liability Obligation	7
3.3. Liability Limitation / Exemption from the Warranty Obligation	7
4. General Safety Instructions for IT Equipment	8
4.1. Electrostatic Discharge (ESD)	10
4.1.1. Grounding Methods	10
4.2. Hot Surface Warning	10
5. Electromagnetic Compatibility	11
5.1. Electromagnetic Compatibility EU	11
5.2. FCC Statement (USA)	11
5.3. EMC Compliance Canada	11
6. Scope of Delivery	12
6.1.1. Optional Parts	12
6.2. Type Label and Product Identification	13
7. Product Description	14
7.1. Front Side View	17
7.1.1. USB Interface Connector on the Front Side of the MC 3 104/121/150/170 Systems	18
7.1.2. MC 3 104/121/150/170 Systems - Front Plate Version	18
7.1.3. Calibrating the Touch Screen (resistive)	19
7.1.4. Touch Screen Care and Cleaning	21
7.1.5. MC 3W 156 System - Front Plate	21
7.2. Bottom View	22
7.2.1. Power and Grounding	23
7.2.2. Power Button and Control Indicators	24
7.2.3. Interfaces (Rear, Bottom Side of the System)	26
7.3. Optional Interfaces	27
7.3.1. RS422/RS485 Serial Interface Connector/s	27
7.3.2. DIP-Switch Settings (SW1) for LPCtoCAN Adapter	29
7.4. Top View	31
7.4.1. CompactFlash™ Slot and SD card Slot	32
7.5. Left and Right Side View	33
7.6. Rear View	34
7.6.1. VESA® Mounting Plate (Option)	35
7.7. Installed SBC	37
7.8. DC Power Connection	37
7.8.1. DC Power Connector	37
7.9. Accessing Internal Components	38
7.9.1. Configuration of the RS422/RS485 Port (MC 3 104/121/150/170, MC 3W 156)	38

7.10. Getting started	40
7.10.1. Connecting to Power	40
7.11. Operating System and Hardware Component Drivers	41
7.12. MC 3/MC 3W System Mounting to a Subframe or Panel	42
8. Maintenance and Prevention	44
9. Technical Data	45
9.1. Electrical Specifications	48
9.1.1. Electrical Specifications for MC 3 104/121/150/170/3W 156 System	48
9.2. Environmental Specifications	48
9.3. Mechanical Specifications	49
9.3.1. Dimensions for MC 3 104/121/150/170 and MC 3W 156	49
9.4. CE Directives and Standards	56
10. Standard Interfaces – Pin Assignments	57
10.1.1. Power Connector	57
10.1.2. Serial interface COM (RS232)	57
10.1.3. Serial Port (RS422/RS485) configured as RS422 (4-Channel Mode)	58
10.1.4. Serial Port (RS422/RS485) configured as RS485 (4-Wire Mode), full duplex, (Bus-Master)	58
10.1.5. Serial Port (RS422/RS485) configured as RS485 (2-Wire Mode), half duplex	59
10.1.6. CAN Connector	59
10.1.7. DP Connector (DisplayPort)	60
10.1.8. USB Port	60
11. Technical Support	61
11.1. Returning Defective Merchandise	61

1.1. Table of Figures

Fig. 1: Bottom view	15
Fig. 2: Right view	15
Fig. 3: Frontal view	15
Fig. 4: Left view	15
Fig. 5: Top view	15
Fig. 6: Rear view	15
Fig. 7: Bottom view	16
Fig. 8: Right view	16
Fig. 9: Frontal view	16
Fig. 10: Left view	16
Fig. 11: Top view	16
Fig. 12: Rear view	16
Fig. 13: Frontal view of the MC 3 104/121/150/170 system (shown as a 10.4" display)	17
Fig. 14: Frontal view of the MC 3W 156 system	17
Fig. 15: Hampshire TSHARC™ Control Panel	19
Fig. 16: Select “Tools” tab	20
Fig. 17: Select “4 Points Calibration”	20
Fig. 18: Touch the calibration targets and complete the calibration	20
Fig. 19: Bottom view of the MC 3 104	22
Fig. 20: Bottom view of the MC 3 156	22
Fig. 21: Detail of the DC Power connector shown without Phoenix terminal	23
Fig. 22: Controls of the MC 3 system (bottom rear side)	24
Fig. 23: Color code for current system power state	24
Fig. 24: Color of the storage drive activity LED, depending on the system configuration	25
Fig. 25: Detail with interfaces for MC 3 104 system	26
Fig. 26: Detail with interfaces for MC 3 121/150/170 and MC 3W 156 systems	26
Fig. 27: Onboard DIP-Switch (SW1) with DP1 up to DP8 for RS422/RS485 serial communication settings	27
Fig. 28: DIP-Switch of the LPCtoCAN Adapter	29
Fig. 29: Color legend used in the Table 4, Table 5 and Table 6:	29
Fig. 30: Top side of the system (shown as MC 3W 156, with CF/SD card slot cover attached)	31
Fig. 31: Top side of the system (shown as MC 3 104, with CF/SD card slot cover removed)	31
Fig. 32: Right side shown as MC 3W 156 system	33
Fig. 33: Left side shown as MC 3W 156 system	33
Fig. 34: Right side of the MC 3 104 system	33
Fig. 35: Left side of the MC 3 104 system	33

Fig. 36: Rear side of the system (shown as a MC 3W 156 system).....	34
Fig. 37: Rear side of the system (shown as a MC 3 104 system)	34
Fig. 38: Rear and bottom view of the mounting plate VESA® 100 compliant for MC 3 104	35
Fig. 39: Rear and bottom view of the mounting plate VESA® 75/100 for MC 3W 156.....	36
Fig. 40: Phoenix power plug terminal with “plus” and “minus” marking (MC 3 104/156/170).....	37
Fig. 41: DIP1–DIP8 switches (shown with factory settings).....	39
Fig. 42: Connecting to DC power source	40
Fig. 43: Detail with mounting clamps and a subframe (shown with a MC 3 104 system)	42
Fig. 44: Detail with mounting clamps and a subframe (shown with a MC 3W 156 system)	42
Fig. 45: Frontal view of the MC 3 104 system	49
Fig. 46: Frontal view of the MC 3 121 system	50
Fig. 47: Frontal view of the MC 3 150 system	50
Fig. 48: Frontal view of the MC 3 170 system	51
Fig. 49: Frontal view of the MC 3W 156 system.....	52

1.2. Tables

Table 1: DIP1, DIP2 and DIP3 settings for serial communication type.....	27
Table 2: DIP4 setting in order to activate or deactivate the termination resistor.....	28
Table 3: DIP5, DIP6, DIP7 and DIP8 settings in order to set the needed timeout and min. baud rate.....	28
Table 4: SJA-Base Address Settings	29
Table 5: SJA-Interrupt Settings	29
Table 6: NVRAM-Operation Mode Settings	30
Table 7: Requirements for the MC 3 104/121/150/170 and MC 3W 156 mounting into a subframe/panel	43

2. Introduction

Kontron Europe would like to point out that the information contained in this manual may be subject to technical alteration, particularly as a result of the constant upgrading of Kontron Europe products. The attached documentation does not entail any guarantee on the part of Kontron Europe with respect to technical processes described in the manual or any product characteristics set out in the manual. Kontron Europe does not accept any liability for any printing errors or other inaccuracies in the manual unless it can be proven that Kontron Europe is aware of such errors or inaccuracies or that Kontron Europe is unaware of these as a result of gross negligence and Kontron Europe has failed to eliminate these errors or inaccuracies for this reason. Kontron Europe expressly informs the user that this manual only contains a general description of technical processes and instructions which may not be applicable in every individual case. In cases of doubt, please contact Kontron Europe.

This manual is protected by copyright. All rights are reserved by Kontron Europe. Copies of all or part of this manual or translations into a different language may only be made with the prior written consent of Kontron Europe. Kontron Europe points out that the information contained in this manual is constantly being updated in line with the technical alterations and improvements made by Kontron Europe to the products and thus this manual only reflects the technical status of the products by Kontron Europe at the time of printing.





© 2013 by Kontron Europe GmbH

Printing and duplication, even of sections, is only permissible with the express approval of

Kontron Europe GmbH
Sudetenstr. 7

87600 Kaufbeuren
Germany

2.1. Symbols used in this User's Guide

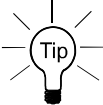
Symbol	Meaning
	This symbol indicates the danger of injury to the user or the risk of damage to the product if the corresponding warning notices are not observed.
	This symbol indicates a hot surface that should not be touched without taking care.
	This symbol indicates that the product or parts thereof may be damaged if the corresponding warning notices are not observed.
	This symbol indicates general information about the product and the user's guide.
	This symbol indicates detail information about the specific product configuration.
	This symbol precedes helpful hints and tips for daily use.

3. Important Instructions

This chapter contains instructions which must be observed when using your Micro Client 3 system. The manufacturer's instructions provide useful information on your device.

3.1. Note on the Warranty

Due to their limited service life, parts which by their nature are subject to a particularly high degree of wear (wearing parts) are excluded from the warranty beyond that provided by law. This applies to batteries, to the display backlighting, for example.

3.2. Exclusion of Accident Liability Obligation

Kontron Europe shall be exempted from the statutory accident liability obligation if the user fails to observe the included document: "General Safety Instructions for IT Equipment" the hints in this manual or eventually the warning signs label on the device.

3.3. Liability Limitation / Exemption from the Warranty Obligation

In the event of damage to the device caused by failure to observe the included document "General Safety Instructions for IT Equipment", the hints in this manual or eventually the warning signs label on the device, Kontron Europe shall not be required to honor the warranty even during the warranty period and shall be exempted from the statutory accident liability obligation.

4. General Safety Instructions for IT Equipment

Please read this section carefully and observe the instructions for your own safety and correct use of the device.

The chapter also contains information on approval and interference suppression of your device.

Observe the warnings and instructions on the device and in the manual.

The MC 3 system has been built and tested by Kontron Europe in accordance to IEC/EN/UL/CSA 60950-1 and left the company in a perfectly safe condition.

In order to maintain this condition and ensure safe operation, the user must observe the instructions and warnings contained in this manual.

- The device must be used in accordance with the instructions for use.
- The electrical installations in the room must correspond to the requirements of the local (country-specific) regulations.
- Take care that there are no cables, particularly power cables, in areas where persons can trip over them.
- Do not use a power cable in sockets shared by a number of other power consumers. Do not use an extension cable.
- Only use the power cord supplied. Don't use injured or damaged power cords.
- For DC power connection:
 - The DC power source should be able to be switched off and on via an isolating switch.
 - The unit is only completely disconnected from the DC main power source, when the DC power cord is disconnected either from the power source or the unit. Therefore, the DC power cord and its connectors must always remain easily accessible.
- For AC power connection via external AC/DC adapter:
 - The main power cable of the external AC/DC adapter serves as disconnecting device. For this reason the outlet of the AC power source must be located near to the device and be easily accessible.
- Do not place the device in direct sunlight, near heat sources or in a damp place. Make sure the device has adequate ventilation.
- Only devices and components which fulfill the requirements of an SELV circuit (safety extra low voltage) in accordance with EN60950 may be connected to the interfaces of the system.
- All plugs on the connection cables must be screwed or locked to the housing.
- The MC 3 system is designed to be used in vertical position with the interfaces downwards.
- The device generates heat during operation. Make sure it is adequately ventilated. Do not cover the air intake and exhaust openings of the device.
- Repairs may only be carried out by qualified specialist personnel authorized by Kontron Europe.
- Maintenance or repair on the open device may only be carried out by qualified personnel authorized by Kontron Europe which is aware of with the associated dangers.
- The MC 3 system may only be opened in accordance with the description in this user's guide for:
 - Replacing of the Lithium battery
 - Configuration of the RS422/RS485 interface
 - Configuration of the CAN interface.These procedures have to be carried-out only by qualified specialist personnel.
- When accessing internal components the device must be switched off and disconnected from the power source.
- Only approved original accessories (optional parts) approved by Kontron Europe may be used.

- ❑ The DC-input must fulfill SELV requirements of EN60950-1 standard.
- ❑ The chassis of the MC 3 system must be protective earthed by establishing a **large-area contact** between the earth screw (at the rear bottom side) and an appropriate grounding connection point.
- ❑ It must be assumed that safe operation is no longer possible,
 - if the device has visible damage or
 - if the device no longer functions.In these cases the device must be shut down and secured against unintentional operation.



4.1. Electrostatic Discharge (ESD)

A sudden discharge of electrostatic electricity can destroy static-sensitive devices or micro-circuitry. Therefore proper packaging and grounding techniques are necessary precautions to prevent damage. Always take the following precautions:

1. Transport boards in ESD-safe containers such as boxes or bags.
2. Keep electrostatic sensitive parts in their containers until they arrive at the ESD-safe workplace.
3. Always be properly grounded when touching a sensitive board, component, or assembly.
4. Store electrostatic-sensitive boards in protective packaging or on antistatic mats.

4.1.1. Grounding Methods

The following measures help to avoid electrostatic damages to the device:

1. Cover workstations with approved antistatic material. Always wear a wrist strap connected to workplace as well as properly grounded tools and equipment.
2. Use antistatic mats, heel straps, or air ionizers for more protection.
3. Always handle electrostatically sensitive components by their edge or by their casing.
4. Avoid contact with pins, leads, or circuitry.
5. Turn off power and input signals before inserting and removing connectors or connecting test equipment.
6. Keep work area free of non-conductive materials such as ordinary plastic assembly aids and styrofoam.
7. Use field service tools such as cutters, screwdrivers, and vacuum cleaners which are conductive.
8. Always place drives and boards PCB-assembly-side down on the foam.

4.2. Hot Surface Warning



Please observe the warning label "Hot Surface" shown in Fig. 36 and Fig. 37 on the rear side of the cabinet. The MC 3/MC3W chassis may be hot during operation and should not be touched without taking care.

The material on bottom surface of the enclosure interior where the MC 3/MC 3W is to be mounted, shall keep at least flammability class UL 94-5VB. Don't put flammable materials under the device.

5. Electromagnetic Compatibility

5.1. Electromagnetic Compatibility EU

This product is in conformity with the protection requirements of EU Council Directive 2004/108/EC on the approximation of the laws of the Member States relating to electromagnetic compatibility. If the user modifies and/or adds to the equipment (e.g. installation of add-on cards) the prerequisites for the CE conformity declaration (safety requirements) may no longer apply.

Generic standards - Emission standard for residential, commercial and light-industrial environments (Emission):
EN 61000-6-3

Emission of Information technology equipment – Radio disturbance characteristics – Limits and methods of measurement:
EN 55022/B

ITE - Immunity characteristics - Limits and methods of measurement: EN 55024

5.2. FCC Statement (USA)





This equipment has been tested and found to comply with the limits for a Class A digital device, pursuant to Part 15 of the FCC Rules. These limits are designed to provide reasonable protection against harmful interference when the equipment is operated in commercial environment. This equipment generates, uses, and can radiate radio frequency energy and, if not installed and used in accordance with the instruction manual, may cause harmful interference to radio communications. Operation of this equipment in residential area is likely to cause harmful interference in which case the user will be required to correct the interference at his own expense.

5.3. EMC Compliance Canada

(English): This Class A digital apparatus complies with the Canadian ICES-003.

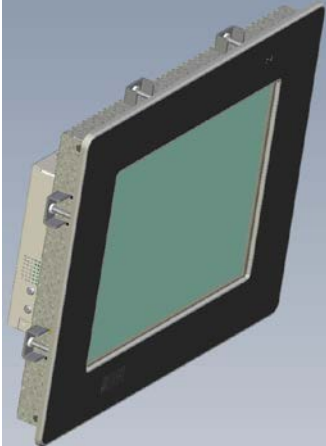
(French): Cet appareil numérique de la class A est conforme à la norme NMB-003 du Canada.

6. Scope of Delivery

	<p>Micro Client 3 and Micro Client 3W system in the configuration ordered:</p> <p>Micro Client 3 104</p> <p>Micro Client 3 121</p> <p>Micro Client 3 150</p> <p>Micro Client 3 170</p> <p>Micro Client 3W 156</p>				
	<p>Phoenix Power Plug Terminal with 2x UNC4/40 (6.4 mm) pan head screw</p>				
<p>Mounting Clamps with Allen Screws</p>	MC 3 104	MC 3 121	MC 3 150	MC 3 170	MC 3W 156
	8x	-	-	-	4x
	-	6x	8x	8x	4x

6.1.1. Optional Parts

- | | |
|---|---|
| <ul style="list-style-type: none"> <input type="checkbox"/> CF card (Type II) <input type="checkbox"/> HDD (2.5" SATA internal) <input type="checkbox"/> SSD (2.5" SATA internal) <input type="checkbox"/> RS232 Module <input type="checkbox"/> RS422/485 Module (configuration via DIP switch) | <ul style="list-style-type: none"> <input type="checkbox"/> CAN Bus Module (LPCtoCAN Adapter) (configuration via DIP switch) <input type="checkbox"/> CANopen Master Module <input type="checkbox"/> PROFIBUS DP Master Module <input type="checkbox"/> Mounting Plate VESA® 100 compliant (particular mounting plates for MC 3 104/121/150/170 and MC 3W 156 respectively) |
|---|---|

6.2. Type Label and Product Identification

System Type	Part Number	Product Identification	Integrated Display
Micro Client 3	2-A0HQ-XXXX	Micro Client 3 104	System with a 10.4" display
	2-A0HR-XXXX	Micro Client 3 121	System with a 12.1" display
	2-A0HS-XXXX	Micro Client 3 150	System with a 15" display
	2-A0HU-XXXX	Micro Client 3 170	System with a 17" display
Micro Client 3W	2-A0HT-XXXX	Micro Client 3W 156	System with a 15.6" display

The /"XXXX"/ group defines the ordered system configuration.

The inspection status label and the Kontron type label (product designation, serial number) are located on the rear side of the device.

7. Product Description

Before you begin using your MC 3 system, you should take a few minutes to learn about the various ports, bays, connectors and indicators that are part of your MC 3 or MC 3W system, as well as the components that make up the system.

The MC 3 /MC 3W is a Human-Machine-Interface (HMI) system designed for demanding industrial applications. It is a workstation system with integrated touch screen display designed for:

- Installation in an instrument panel or other cabinets
- Installation by VESA® 100 compliant mounting system



All versions are suitable for installation in an instrument panel or other cabinet.

MC 3 / MC 3W systems will be mounted in an instrument panel or other cabinets using the corresponding included mounting clamps.

The MC 3 system is equipped with a 10.4", a 12.1", a 15" or a 17" display. In front of the display there is installed a resistive touch screen, that also protects the display surface from dirt and scratches.

The MC 3W system is equipped with a 15.6" display and a capacitive touch screen providing multi-touch function.

The rugged design with an excellent mechanical stability marks the superior qualities of a computer suitable for the operation in harsh industrial environment.

The MC 3 system accommodates a single computer board (SBC) with optionally available externally accessible CompactFlash™ (IDE) and SD card modules. The system can be optionally equipped with a CF type II card and/or an SD card and/or an internal 2.5" HDD/SSD (SATA) and/or an MSATA module.

The power LED and the Power button are located on the bottom side of the MC 3/ MC 3W system (interface side). Interfaces such as 1x serial COM1 (RS232), 2x LAN (10/100/1000 Mbps), 2x USB (2.0), 2x USB 3.0, 1x DP are provided. Additionally, the MC3 104/121/150/170 systems provide a front USB 2.0 connector.

Optionally, the MC 3/MC 3W system can be equipped with additional serial [RS422/RS485]] and or RS232 interfaces or CAN BUS interfaces via a corresponding internal modules.



Available locations for the additional interfaces:

To the MC 3 104 systems can be installed up to two different modules for (RS422/485) / CAN-BUS interfaces and/or an additional serial Port COM2 as RS232.

To the MC 3 121/150/170 and MC 3W 156 systems can be installed up to three modules as (RS422/485) or CAN-BUS interface or an additional serial Port COM2 as RS232.

The MC 3/MC 3W system is designed to be connected to a +24VDC (+/-20%) power supply using the DC power terminal (included). In order to connect the system to an AC power supply, an optional external AC/DC adapter can be ordered.



The MC 3W system is designed to comply with IP65 Protection class at the front side.

The MC 3 104/121/150/170 systems only comply with IP65 protection class at the front side, if the front side USB connector is covered by the elastic captive rubber coat.

The MC 3/MC 3W system is a fanless system. The cooling of the unit is performed by the surface of the chassis.

The air openings, located on the top and sides of the device provide air circulation for the system interior cooling, in order to prevent overheating.



When powering on the MC 3/MC 3W system, make sure that the air intake and exhaust openings are not obstructed.



Fig. 1: Bottom view



Fig. 2: Right view

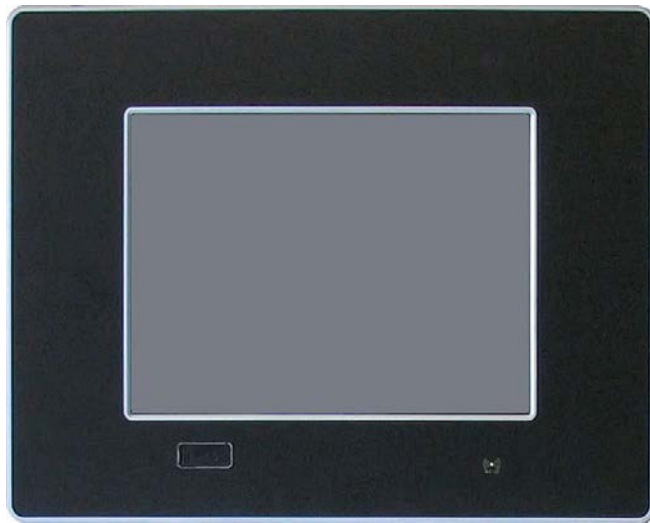

Fig. 3: Frontal view



Fig. 4: Left view



Fig. 5: Top view



Fig. 6: Rear view

In these pictures (Fig. 1 up to Fig. 6) the MC 3 system is shown as an MC 3 104 unit.



Fig. 7: Bottom view



Fig. 8: Right view



Fig. 9: Frontal view



Fig. 10: Left view



Fig. 11: Top view



Fig. 12: Rear view

In these pictures (Fig. 7 up to Fig. 12) the MC 3 system is shown as an MC 3W 156 unit.

7.1. Front Side View

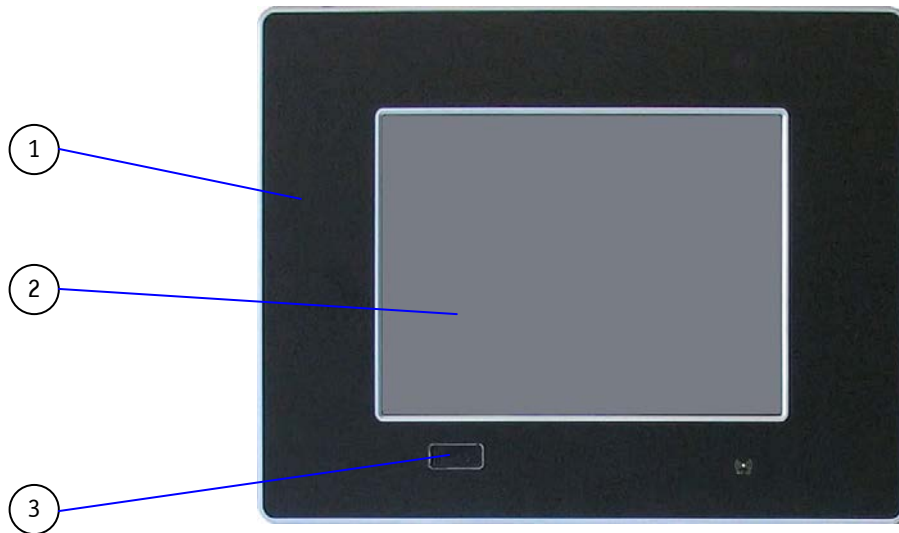

Fig. 13: Frontal view of the MC 3 104/121/150/170 system (shown as a 10.4" display)

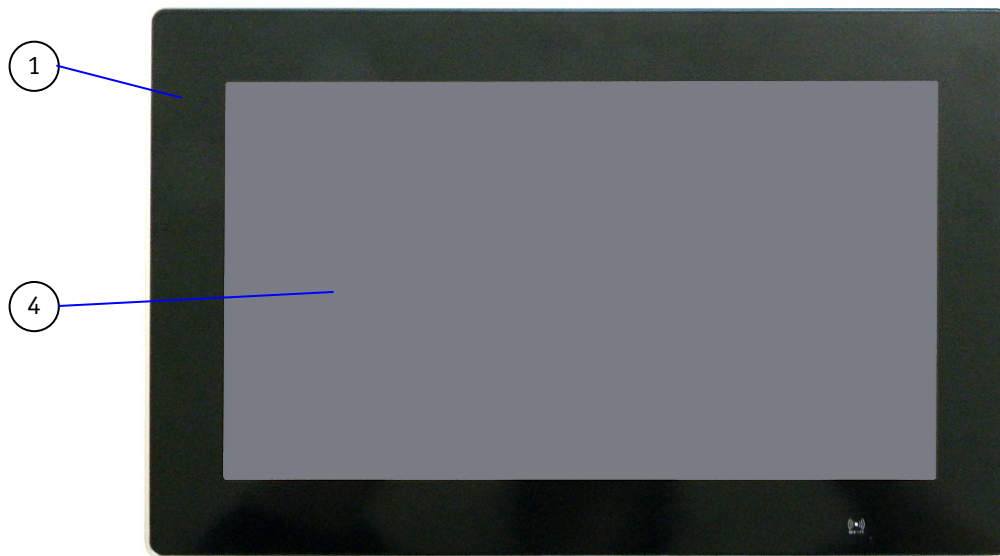

Fig. 14: Frontal view of the MC 3W 156 system

Legend for Fig. 13 and Fig. 14:

- | | |
|---|---|
| 1 Front plate | 3 Covered USB interface (available at MC3 104/121/150/170 only) |
| 2 10.4"/12.1"/15"/17" TFT display with touch screen | 4 15.6" TFT display with multitouch screen |

7.1.1. USB Interface Connector on the Front Side of the MC 3 104/121/150/170 Systems

This USB 2.0 connector allows you to connect different USB-compatible devices to the MC 3 system. The USB connector is covered by an elastic captive rubber coat. The rubber coat prevents the penetration of fluid if no device is connected.



The MC 3 104/121/150/170 systems only comply with IP65 protection class at the front side, if the front side USB connector is covered by the elastic captive rubber coat.



The USB interface connector is available only on the front side of the MC 3 104/121/150/170 system. The MC 3W 156 system is not equipped with the USB interface on the front side.

7.1.2. MC 3 104/121/150/170 Systems - Front Plate Version

All MC 3 104/121/150/170 system versions are suitable for installation in an instrument panel or other cabinet. At the front side of the 104/121/150/170 system, an aluminum front plate with polyester front foil is located.

For the outline dimensions of display unit of your system (MC 3 104/121/150/170) please refer to the chapter 9.3 "Mechanical Specifications".

7.1.2.1. TFT Display 10.4"/12.1"/15"/17" with Touch Screen (resistive)

Depending on the ordered MC 3 system the built-in display is a 10.4"/12.1"/15"/17" size TFT display with corresponding resistive touch screen. The touch screen is USB connected.

For technical specification of the built-in display refer to the chapter 9 "Technical Data".

The display is equipped with a resistive touch screen. The touch screen offers the same degree of user comfort as the mouse buttons.

The surface of the display is also mechanically protected through the touch screen. The touch screen (USB connected) registers contacts of a finger or a pen and allows moving the mouse pointer. This functions only by integration of the necessary software. The corresponding touch screen driver for your operating system is installed on your MC 3 system.



Do not use a hard or a pointed object (like screw drivers) to operate the touch screen, since it can damage the touch screen surface.

The front panel (MC 3 104/121/150/170) and the touch screen are covered by a plastic overlay and care should be taken when cleaning it (see the chapter 7.1.4 "Touch Screen Care and Cleaning").

7.1.3. Calibrating the Touch Screen (resistive)

Calibration serves two purposes:

- Sets the active area of the touch screen
- Aligns the active area of the touch screen to the screen’s image.



Before you calibrate the touch screen, let the system warm up for 30 minutes.

Calibration aligns the active touch-sensitive area of the touch screen with the image on the display. Calibration also determines the edges of the screen’s image and locates the center of the touch screen. If the touch screen is not calibrated properly, the active area of the touch screen may not be aligned with the screen’s image or may be unnecessarily small in size. If necessary, in order to access the calibration routine, use an USB mouse.

7.1.3.1. Calibrate the Touch Screen for Windows® 7 / Windows® 7 Embedded / Windows® Embedded Compact 7 / Windows® XP embedded

The touch screen of your MC 3 system is factory calibrated. Run the calibration routine when an alignment problem exists between the mouse pointer and the finger/stylus contact location on the screen. You can adjust the touch screen calibration by performing the following steps:

- Run the touch screen property sheet from the Start-Programs by clicking on “Configure Utility” in the “eGalax Touch” menu entry:

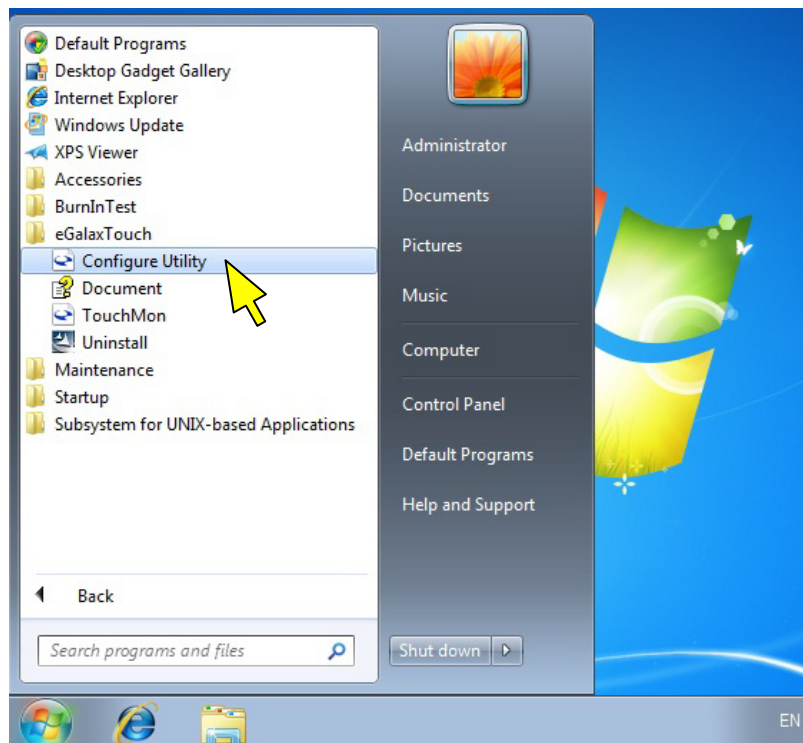

Fig. 15: Hampshire TSHARC™ Control Panel

Select the “Tools” tab. Then select the “4 Points Calibration” Button (refer to Fig. 16 and Fig. 17) and touch the calibration targets as accurately as possible.

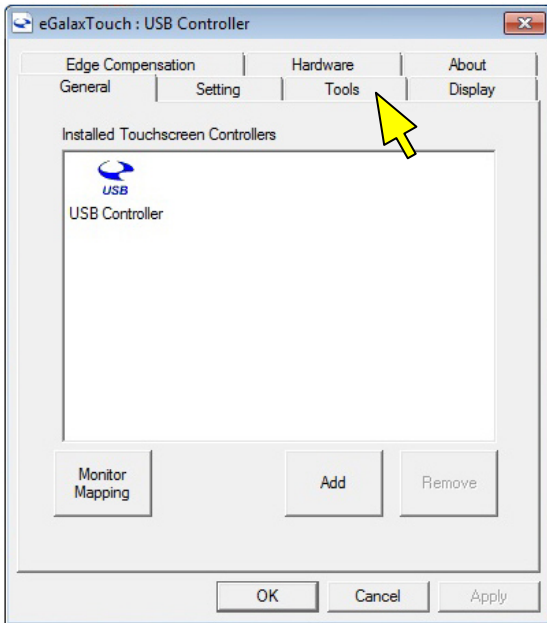

Fig. 16: Select "Tools" tab

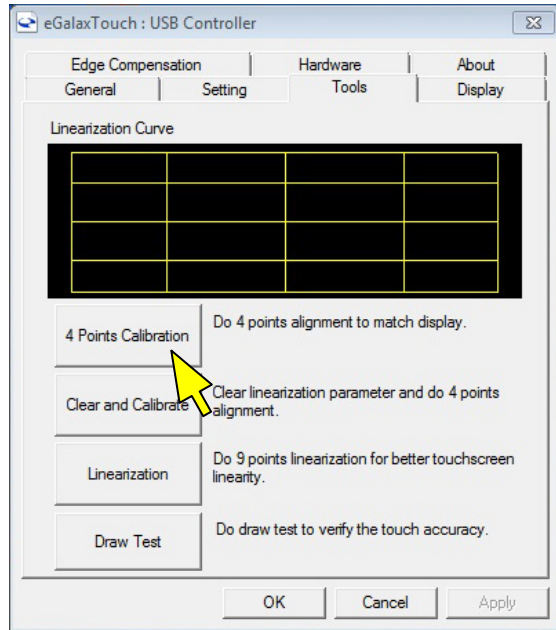

Fig. 17: Select "4 Points Calibration"

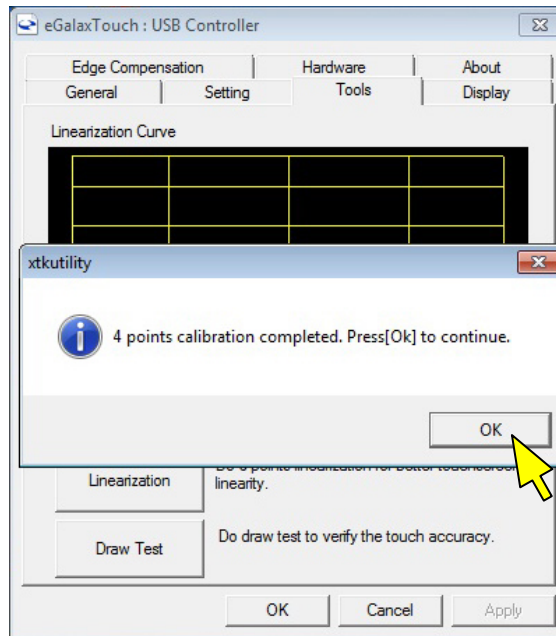

Fig. 18: Touch the calibration targets and complete the calibration

Complete the calibration process by selecting the "OK" button.

7.1.4. Touch Screen Care and Cleaning



The front panel and the touch screen are covered by a plastic overlay and care should be taken when cleaning it.

Mild detergent and water is recommended for cleaning. Use of strong solvents, which could attack paint or plastic, should be avoided.

The plastic overlay or the touch screen surface is subject to burning and scaring from direct heat sources such as cigarettes. The display front is sealed against dust, liquids, etc.

The front surface of the touch screen is protected by a flexible plastic foil, so care should be used to avoid using sharp objects such as knife, pen or pencil tips. Sharp objects can permanently damage the functionality of the touch screen. Units without a touch screen have a polycarbonate shield, which could be scratched by a sufficiently sharp object.

7.1.5. MC 3W 156 System - Front Plate

The MC 3W 156 system is suitable for installation in an instrument panel or other cabinet.

At the front side of the system, an aluminum front plate with integrated anti-glare glass plate and capacitive touch is located.

For the outline dimensions of display unit of your system please refer to the chapter 9.3 "Mechanical Specifications".

7.1.5.1. TFT Display 15.6" Size with Touch Screen (capacitive)

Unlike the resistive touch displays, the capacitive touch screen needs no further calibration after factory calibration. Only special, conductive styluses (not included) work with capacitive touch screens.



The capacitive touch screen is factory-calibrated and needs no recalibration.

When using a stylus (not included), make sure to use a special conductive stylus that works with capacitive touch screens

7.2. Bottom View

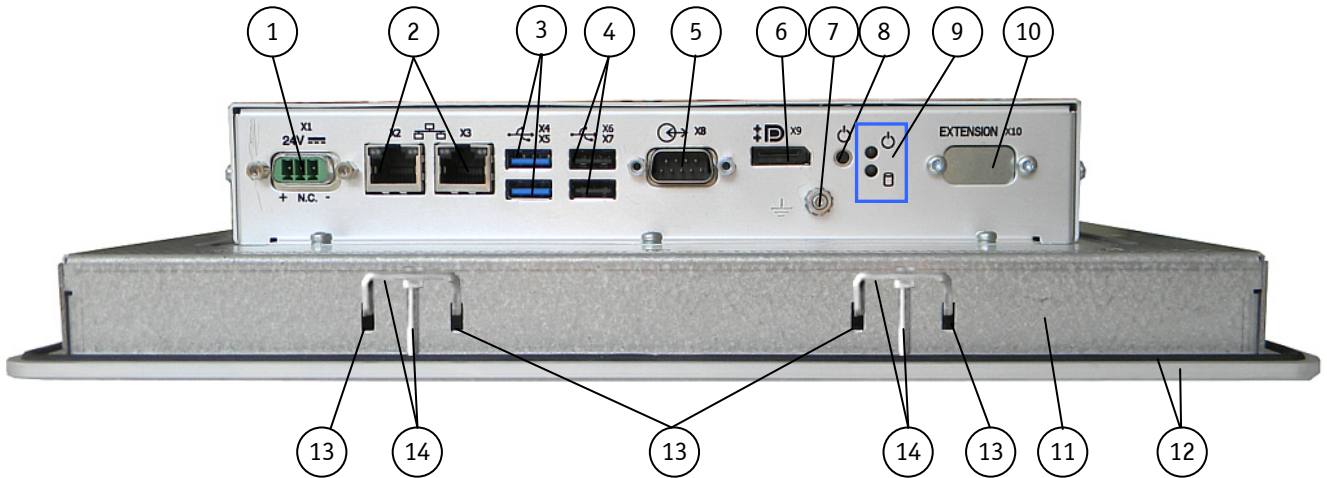

Fig. 19: Bottom view of the MC 3 104

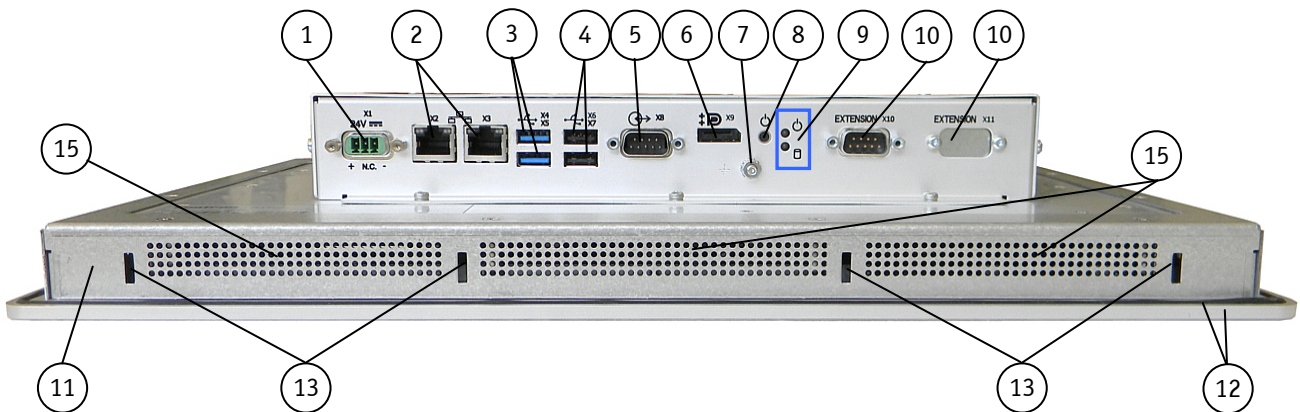

Fig. 20: Bottom view of the MC 3 156

Legend for Fig. 19 and Fig. 20:

- | | |
|---|--|
| <ul style="list-style-type: none"> 1 DC power connector 2 2x Ethernet connector (RJ45) 10/100/1000 Mbps) 3 2x USB (3.0) connector (blue) 4 2x USB (2.0) connector 5 1x COM1 (RS232) serial port connector (DSUB, 9-pin) 6 1x DisplayPort 7 Grounding screw with lock washers 8 Power button 9 LED indicators (power and HDD) | <ul style="list-style-type: none"> 10 Optional interface (CAN-BUS and/or RS422/485 interfaces for MC 3 104/121/150/170 and MC 3W 156) 11 Display enclosure 12 Front panel of the system with seal at the rear side 13 Mounting slots for mounting clamps 14 Small mounting clamp with Allen screw (shown for the MC 3 104) 15 Air openings on the display side |
|---|--|



In the MC3 121/150/170 and MC 3W 156 systems up to three different modules for (RS422/485) or RS232 or CAN-BUS interfaces can be installed.

In the MC 3 104 systems two modules for (RS422/485) or RS232 or CAN-BUS interface can be installed.

7.2.1. Power and Grounding

7.2.1.1. DC In Power Connector



Fig. 21: Detail of the DC Power connector shown without Phoenix terminal

The MC 3/MC 3W system is supplied with a 3-pin Phoenix power connector terminal (refer to Fig. 40). The DC Power connector (Fig. 21) provides the power connection of the MC 3/MC 3W system to the main power source via a DC power cable (not included). For pin-assignment of this connector refer to the chapter 10.1.1 “Power Connector”.

7.2.1.2. Grounding Screw (M4) with lock Washers

The chassis of the MC 3/MC 3W system must be grounded by establishing a **large-area contact** between the grounding stud M4x10 (DIN7985) with 2x lock washer M4 (DIN6797) and nut M4 (Fig. 19, Fig. 20, pos. 7, and Fig. 22, pos. 4), and an appropriate grounding connection point. The minimum cross section of the grounding conductor is 1mm² (AWG 18).

7.2.2. Power Button and Control Indicators

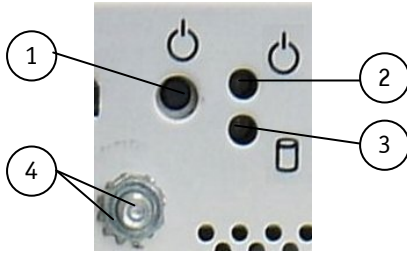

Fig. 22: Controls of the MC 3 system (bottom rear side)

- 1 Power button
- 2 Power LED
- 3 HDD LED
- 4 Grounding stud with lock washers

7.2.2.1. Power Button

The power button (Fig. 19, Fig. 20, pos. 7, and Fig. 22, pos. 1) allows to power ON/OFF the system.



Even when the system is turned off via the power button there is still a standby-voltage of 5 V on the SBC. The system is not completely disconnected from the main power supply by turning off via the power button.

Hints for DC power connection:

The DC main power supply should be able to be switched off and on via a 2-pole isolating switch. The unit is only completely disconnected from the DC main power supply, when the DC power cord is disconnected either from the DC main or the unit. Therefore, the DC power cord and its connectors must always remain easily accessible.

7.2.2.2. Power LED

The power LED (Fig. 22, pos. 4) indicates the current system power state (S0, S3, S4, or S5) as shown in shown in Fig. 23. The power LED will blink red if an error condition was detected (the system is held off). The color red is reserved for error codes, only.

Color	System State
Off	Power off or EC failure
Red	System held off (i.e. over-temperature, etc.)
Orange	System in S3/S4/S5
Green	System in S0

Fig. 23: Color code for current system power state

An over-temperature condition has the highest of all priorities. The power button is deactivated as long as the temperature is too high. To signalize this emergency state, the LED lights up red.

7.2.2.3. Storage Drive Activity LED



The MC 3 /MC 3 W systems can be optionally equipped with a CF card and/or an SD card and/or an internal 2.5" HDD (SATA) and/or an MSATA module.

Refer to Fig. 22, pos. 3 for the storage drive activity LED location. Depending on the system configuration and storage drive/s activity this LED may be blinking as shown below:

Color	Storage State
Off	No activity on SATA / mSATA / SD-card / CF-card
Orange	SATA / mSATA activity
Green	SD-card / CF-card activity

Note: activity on SATA / mSATA has a higher priority than SD-card / CF-card

Fig. 24: Color of the storage drive activity LED, depending on the system configuration

7.2.3. Interfaces (Rear, Bottom Side of the System)

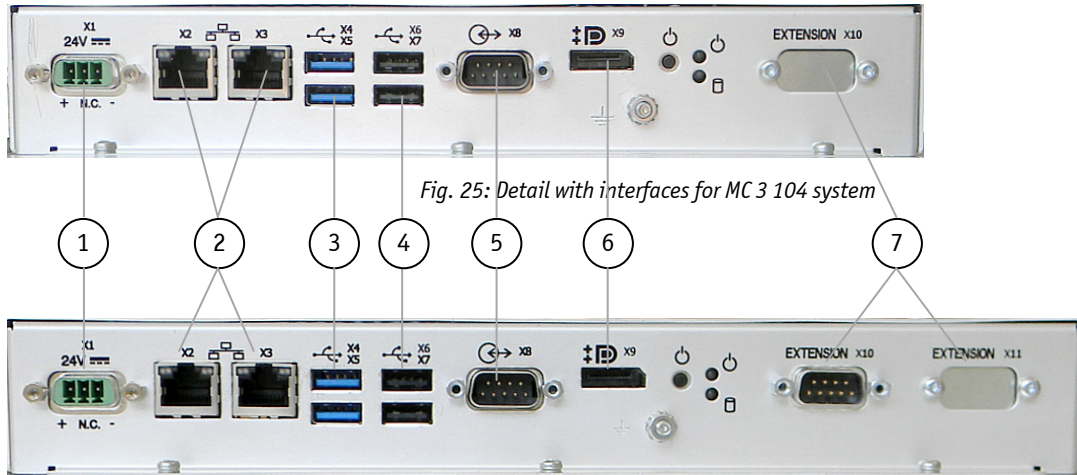

Fig. 25: Detail with interfaces for MC 3 104 system

Fig. 26: Detail with interfaces for MC 3 121/150/170 and MC 3W 156 systems

Legend for Fig. 25 and Fig. 26:

- | | |
|----------------------------|---|
| 1 DC power connector | 5 COM1 (RS232) serial port connector |
| 2 2x LAN (1Gbps) connector | 6 Display Port connector |
| 3 2x USB 3.0 connector | 7 Optional interfaces (shown as CAN-BUS for MC 3W 156 system) |
| 4 2x USB 2.0 connector | |

7.2.3.1. LAN0 and LAN1 Ethernet Interface Connectors

These interface connectors (Fig. 19, Fig. 20, pos. 5 and Fig. 25, Fig. 26 pos. 2) are provided as RJ45 sockets with integrated LEDs and support a 10/100/1000 Mbps data transfer rate.

Ethernet LED States:

Left LED State	Link Activity State	Right LED State	Link Speed
off	Link not active	Off	10 Base-T
yellow	Link active	green	100 Base-T
yellow (blinking)	Link active	green (flashing)	1000 base-T

7.2.3.2. USB Connectors

The system is equipped at the bottom side (rear) with two USB 2.0 and two USB 3.0 interface connectors (Fig. 19, Fig. 20, pos. 3, pos. 4 and Fig. 25, Fig. 26 pos. 3, pos. 4). These connectors provide connections for USB-compatible devices.

7.2.3.3. DisplayPort Interface Connector

An external (digital) monitor can be plugged into this interface (Fig. 19, Fig. 20, Fig. 25 and Fig. 26 pos. 6).

7.2.3.4. COM1 Serial Interface Connector

This RS232 connection (marked as COM1) (Fig. 19, Fig. 20, pos. 4 and Fig. 25, Fig. 26 pos. 5) are available as 9-pin D-SUB connectors (female) and provides connection (RS232) for serial devices.

7.3. Optional Interfaces

The optional interfaces (Fig. 25, Fig. 26 pos. 7 and Fig. 30, Fig. 31, pos. 8) shown as CAN-BUS for MC 3 104 and as RS422/485 interface for MC 3 121/150/170 and MC 3W 156 systems must be custom ordered. Depending on your requirements, you can choose the type of the optional interface/s: RS232, RS422/485, RS422/485 isolated 1.5kV CANopen, PROFIBUS, LPCtoCAN(SJA1000) adapter and Real Ethernet.



For MC 3 104 systems:

The optional interface locations (Fig. 25, pos. 7 and Fig. 30, pos. 8) can be fitted with:

- up to two different interfaces: RS422/485 and/or CANopen, PROFIBUS
CANopen, PROFIBUS and/or RS232 and/or LPCtoCAN
or only Real ethernet

For MC 3 121/150/170/ and MC 3W 156 systems:

The optional interface locations (Fig. 26 pos. 7 and Fig. 31, pos. 8) can be fitted with:

- up to three different interfaces: RS422/485 and/or CANopen, PROFIBUS
CANopen, PROFIBUS and/or RS232 and/or LPCtoCAN
or only Real ethernet

7.3.1. RS422/RS485 Serial Interface Connector/s

If one of the optional interfaces of your system is an RS422/485 serial interface (Fig. 19, Fig. 20, Fig. 25 and Fig. 26 pos. 1) it is available as 9-pin D-SUB connector (female). The interface can be configured via an on-board DIP switch (SW1) for RS422 or RS485 serial communication.

The optional settings (SW1) for RS485 mode communication allow the system’s operation either in full duplex mode or in half duplex mode (see tables on the next page). While running in RS485 half duplex mode the system stays permanently in a receiver mode. The switch to transmission mode will be done automatically. The user can determine if the automatic mode switch to transmission mode should be triggered by the RTS-line or should be triggered by the last sent message using the TxD line.

If triggered by RTS has been selected, then the RTS-signal must be activated by the application software before transmission of the data packets starts; and RTS signal has to be disabled again after termination of data transmission.

If TxD line will be used for the mode transceiver switch process, the receiver device has to follow a timeout before starting to send any data.



Fig. 27: Onboard DIP-Switch (SW1) with DP1 up to DP8 for RS422/RS485 serial communication settings

In order to configure this interface for serial communication (as RS422 or RS485) corresponding to your requirements, set the switches of the DIP switch (SW1) to “ON” or “OFF” (factory settings are marked grey). For accessing the DIP switch refer to the procedure described in the chapter 7.9.1 “Configuration of the RS422/RS485 Port”.

Serial Communication Type	Transmitting<->receiving	SW1 Settings		
		DIP1	DIP2	DIP3
RS422 4-Channel Mode	-	OFF	OFF	OFF
RS485 4-Wire Mode (Bus-Master)	-	ON	OFF	ON
RS485 2-Wire Mode	RTS	ON	ON	ON
RS485 2-Wire Mode	Timeout	ON	ON	OFF

Table 1: DIP1, DIP2 and DIP3 settings for serial communication type

Termination Resistor for RS422 and RS485	SW1 Settings
	DIP4
Deactivated	OFF
Activated	ON

Table 2: DIP4 setting in order to activate or deactivate the termination resistor

Timeout	Min. Baud Rate	SW1 Settings			
		DIP5	DIP6	DIP7	DIP8
10.2ms	1200	OFF	OFF	OFF	OFF
9.6ms		OFF	OFF	OFF	ON
9.0ms		OFF	OFF	ON	OFF
8.4ms		OFF	OFF	ON	ON
7.8ms		OFF	ON	OFF	OFF
7.2ms		OFF	ON	OFF	ON
6.5ms		OFF	ON	ON	OFF
5.9ms		OFF	ON	ON	ON
4.8ms	2400	ON	OFF	OFF	OFF
4.3ms		ON	OFF	OFF	ON
3.7ms		ON	OFF	ON	OFF
3.1ms		ON	OFF	ON	ON
2.5ms	4800	ON	ON	OFF	OFF
1.9ms		ON	ON	OFF	ON
1.2ms	9600	ON	ON	ON	OFF
0.6ms	19200	ON	ON	ON	ON

Table 3: DIP5, DIP6, DIP7 and DIP8 settings in order to set the needed timeout and min. baud rate

7.3.2. DIP-Switch Settings (SW1) for LPCtoCAN Adapter

The DIP-switch is for setting the SJA1000-base address, the SJA-interrupt, and the NVRAM operation mode.

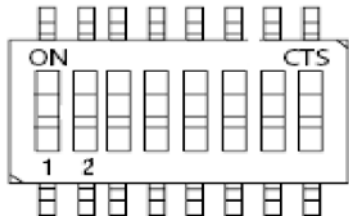

Fig. 28: DIP-Switch of the LPCtoCAN Adapter

	Factory settings for one LPCtoCAN adapter
	Factory settings for two LPCtoCAN adapters

Fig. 29: Color legend used in the Table 4, Table 5 and Table 6:

7.3.2.1. SJA Base Address (SW1: 1-3)

Switch			Address Range
3	2	1	
OFF	OFF	OFF	0x340 to 0x35F*
OFF	OFF	ON	0x320 to 0x33F*
OFF	ON	OFF	0x300 to 0x31F
OFF	ON	ON	0x220 to 0x23F*
ON	OFF	OFF	0x200 to 0x21F*
ON	OFF	ON	0x140 to 0x15F*
ON	ON	OFF	0x120 to 0x13F*
ON	ON	ON	0x100 to 0x11F*

Table 4: SJA-Base Address Settings

*These settings are not usable for Micro Client 3!

7.3.2.2. SJA-Interrupt (SW1: 4-6)

Switch			IRQ
6	5	4	
OFF	OFF	OFF	disabled*
OFF	OFF	ON	15*
OFF	ON	OFF	11*
OFF	ON	ON	10
ON	OFF	OFF	7*
ON	OFF	ON	5*
ON	ON	OFF	4*
ON	ON	ON	3*

Table 5: SJA-Interrupt Settings

*These settings are not usable for Micro Client 3!

7.3.2.3. NVRAM-Operation Mode (SW1: 7-8)

Switch		Mode
8	7	
OFF	OFF	disabled
OFF	ON	IO-mode
ON	OFF	Memory at C0000
ON	ON	Memory at D0000

Table 6: NVRAM-Operation Mode Settings

7.4. Top View

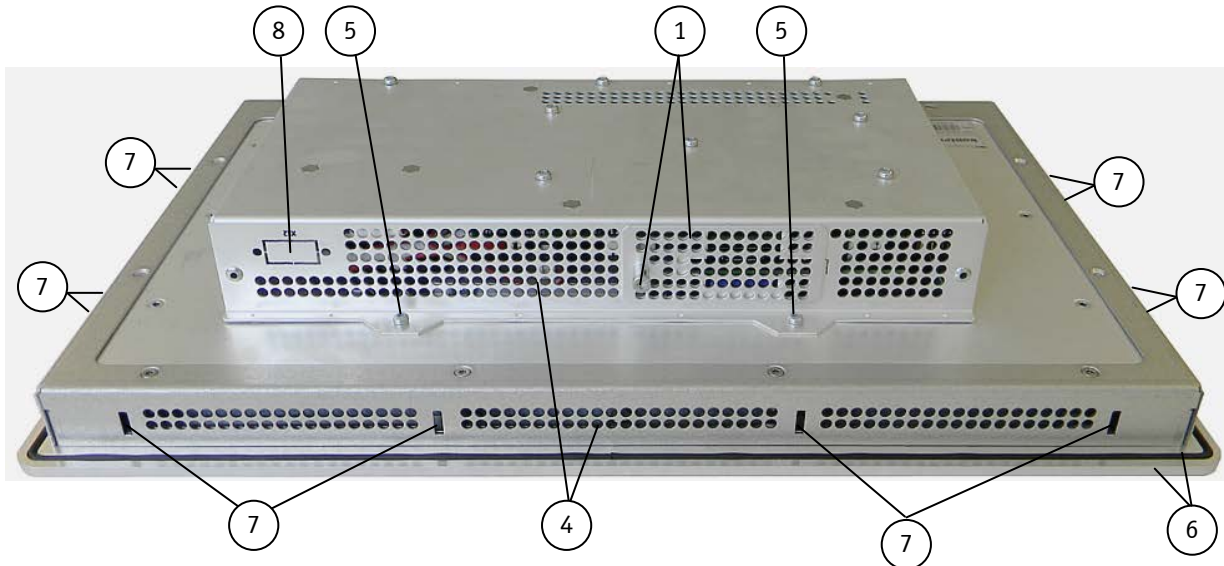

Fig. 30: Top side of the system (shown as MC 3W 156, with CF/SD card slot cover attached)

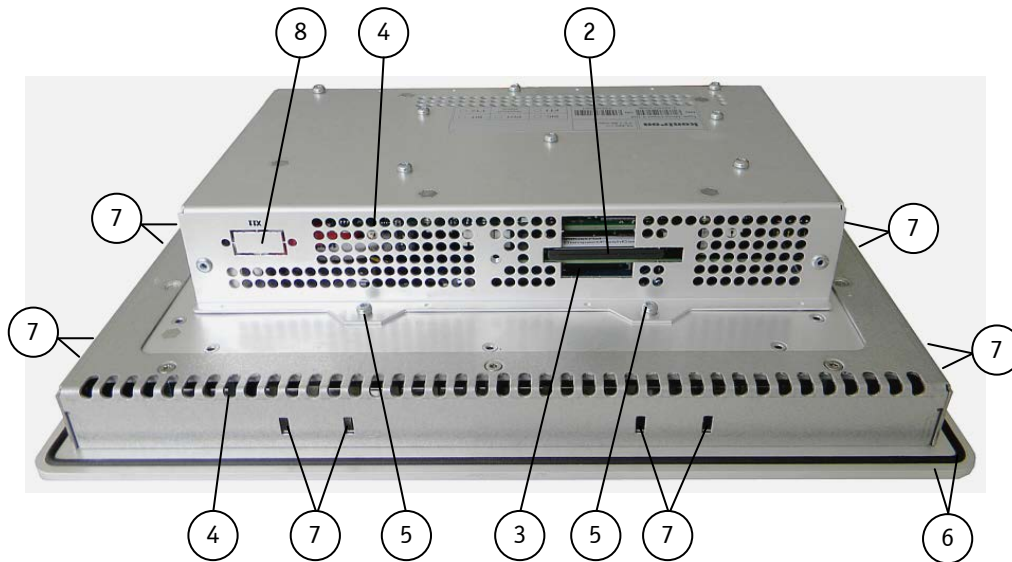

Fig. 31: Top side of the system (shown as MC 3 104, with CF/SD card slot cover removed)

Legend for Fig. 30 and Fig. 31:

- | | |
|--|--|
| 1 CF/SD card slot cover with captive screw | 5 Screws that secure the cover on the top side |
| 2 CompactFlash™ slot (with CF card) | 6 Front panel with seal on the rear side |
| 3 SD card slot | 7 Mounting slots for mounting clamps |
| 4 Air exhaust openings | 8 Cutout for optional interfaces |



When powering on the MC 3 system, make sure that the air intake and exhaust openings are not obstructed.

7.4.1. CompactFlash™ Slot and SD card Slot

The system is equipped with a CompactFlash™ slot and an SD card slot. Both slots are located on the rear top side. The CF slot accepts only CF cards type II.



Before installing or removing the Compact Flash™ card or the SD card, the MC 3 system must be powered down and disconnected from the power source.



The MC 3 104/121/150/170 and MC3 156 systems are equipped with a cover in order to cover the CF/SD slot, (refer to Fig. 30, pos. 1 and Fig. 31, pos. 2).

7.5. Left and Right Side View

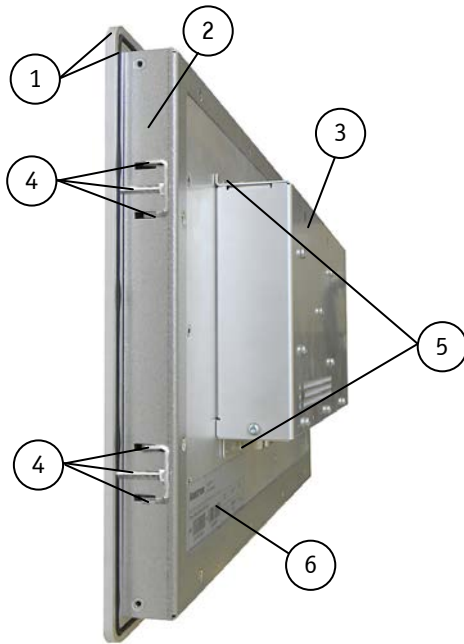

Fig. 32: Right side shown as MC 3W 156 system

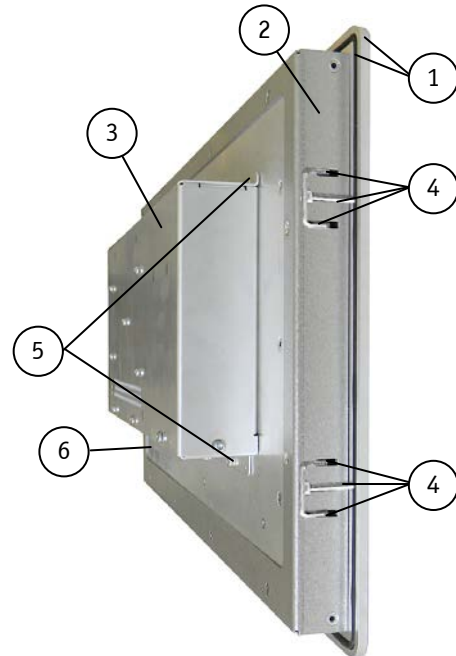

Fig. 33: Left side shown as MC 3W 156 system

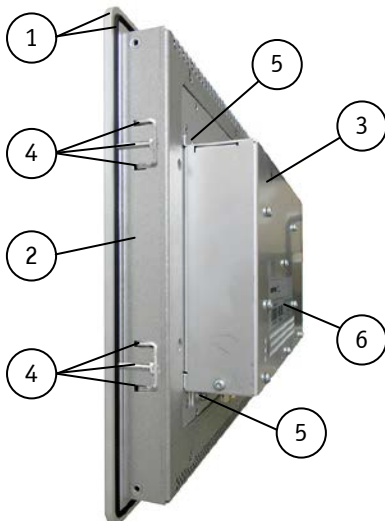

Fig. 34: Right side of the MC 3 104 system

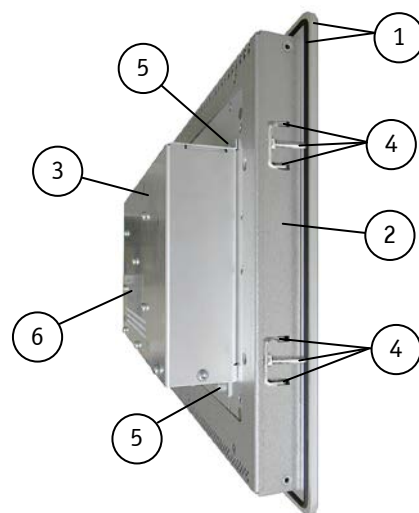

Fig. 35: Left side of the MC 3 104 system

Legend for Fig. 32, Fig. 33, Fig. 34 and Fig. 35:

- | | |
|--|--|
| 1 Front panel of the system with seal at the rear side | 4 Mounting slots with installed mounting clamp and Allen Screw |
| 2 Enclosure of the display | 5 Screws that secure the cover on the top and bottom side |
| 3 System cover | 6 Type label of the MC 3 system with C-UL Listing Mark |

7.6. Rear View

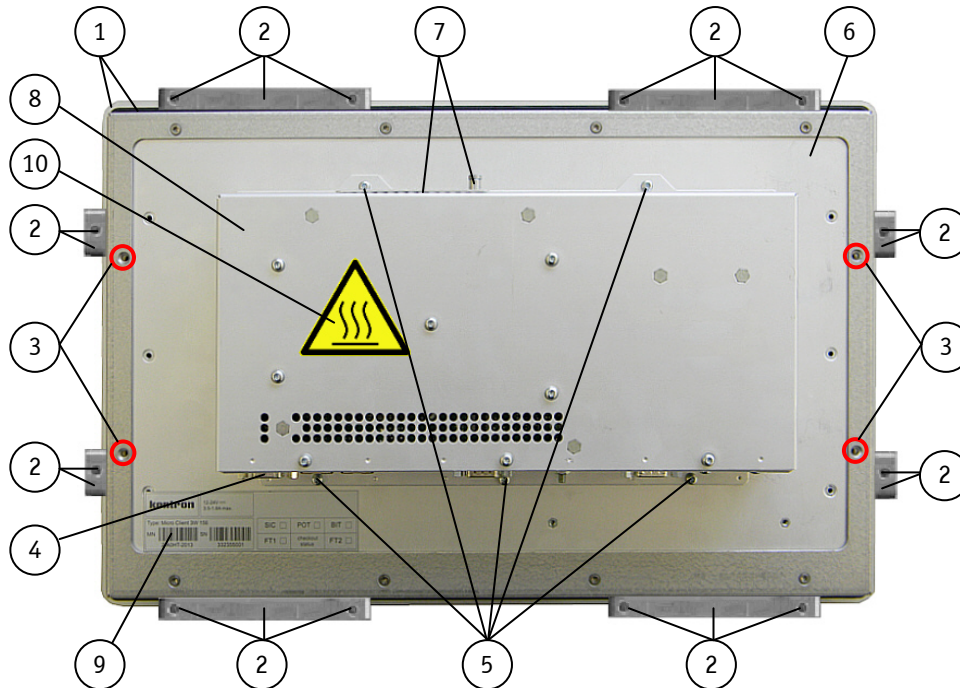

Fig. 36: Rear side of the system (shown as a MC 3W 156 system)

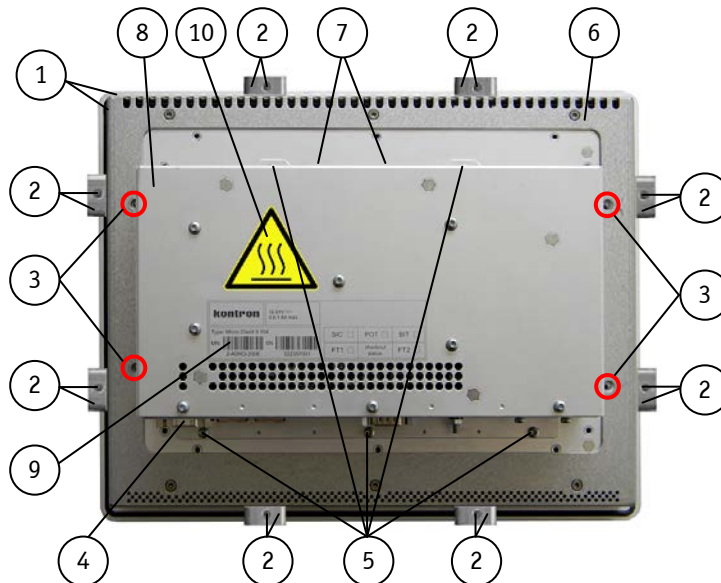

Fig. 37: Rear side of the system (shown as a MC 3 104 system)

Legend for Fig. 36 and Fig. 37:

- | | |
|---|--|
| 1 Front panel of the system with seal at the rear side | 5 Screws that secure the system cover on the rear side |
| 2 Mounting clamp with Allen screw(s) for mounting to a subframe | 6 Enclosure of the display |
| 3 Threaded hole [marked red in the picture only (4x for mounting the VESA® 100 compliant, adapter plate); refer to the 7.6.1 "VESA® Mounting Plate (Option)"] | 7 CF/SD card slot cover with captive screw |
| 4 Interface side | 8 System cover |
| | 9 Type label of the system |
| | 10 Hot surface warning label |



The MC 3 system can be installed with the optional VESA® 100 compliant adapter plate.

- ❑ MC 3 104/121/150/170 is VESA® 100 compliant (refer to Fig. 38).
- ❑ MC 3W 156 is also VESA® 100 compliant (refer to Fig. 39).

7.6.1. VESA® Mounting Plate (Option)

The device is designed to be operated in vertical position (with the interfaces downwards) mounted to a VESA® 100 compliant mounting system.



Each of the VESA® 100 compliant mounting plates must be fastened to the appropriate MC 3 system (refer to pos. 3, Fig. 36 and Fig. 37) with four M4x6 metric screws.



Do not use longer screws than the original screws provided (M4x6 metric). Using longer screws damage the internal components of the system.



Please observe the warning label "Hot Surface" shown in Fig. 36 and Fig. 37 on the rear side of the cabinet. The MC 3/MC3W chassis may be hot during operation and should not be touched without taking care.

The material on bottom surface of the enclosure interior where the MC 3/MC 3W is to be mounted, shall keep at least flammability class UL 94-5VB. Don't put flammable materials under the device.

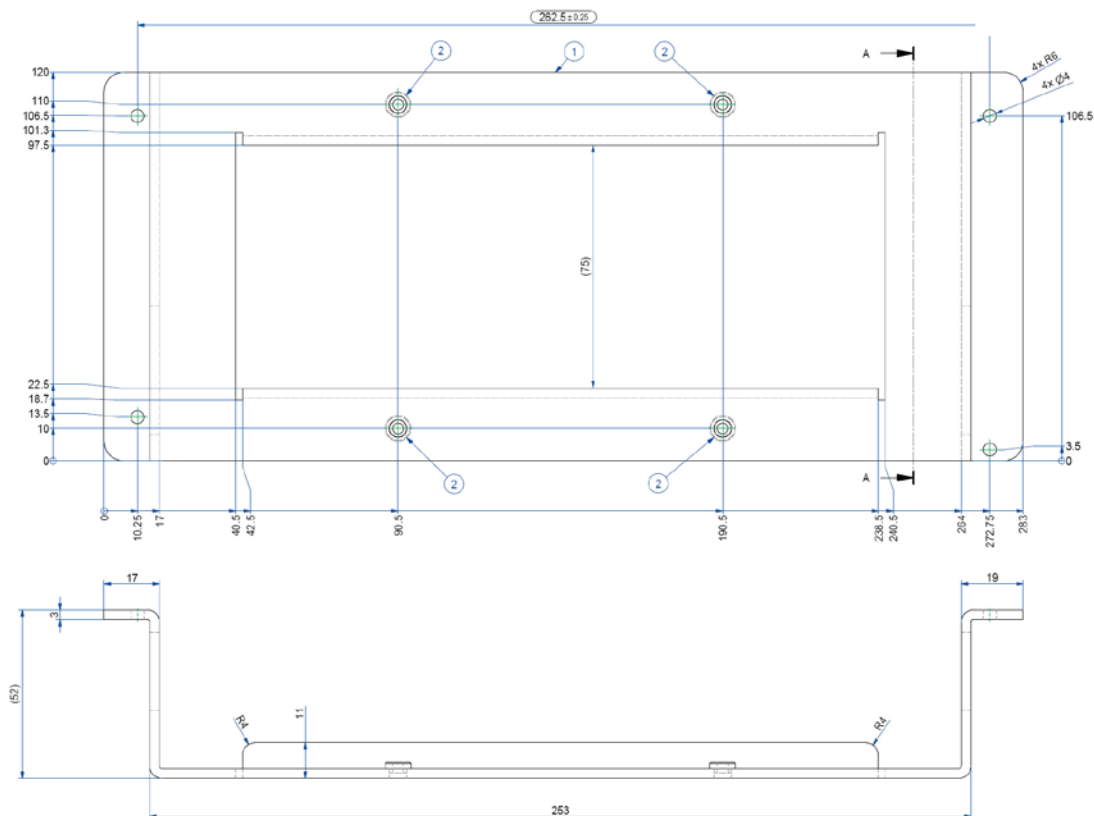

Fig. 38: Rear and bottom view of the mounting plate VESA® 100 compliant for MC 3 104

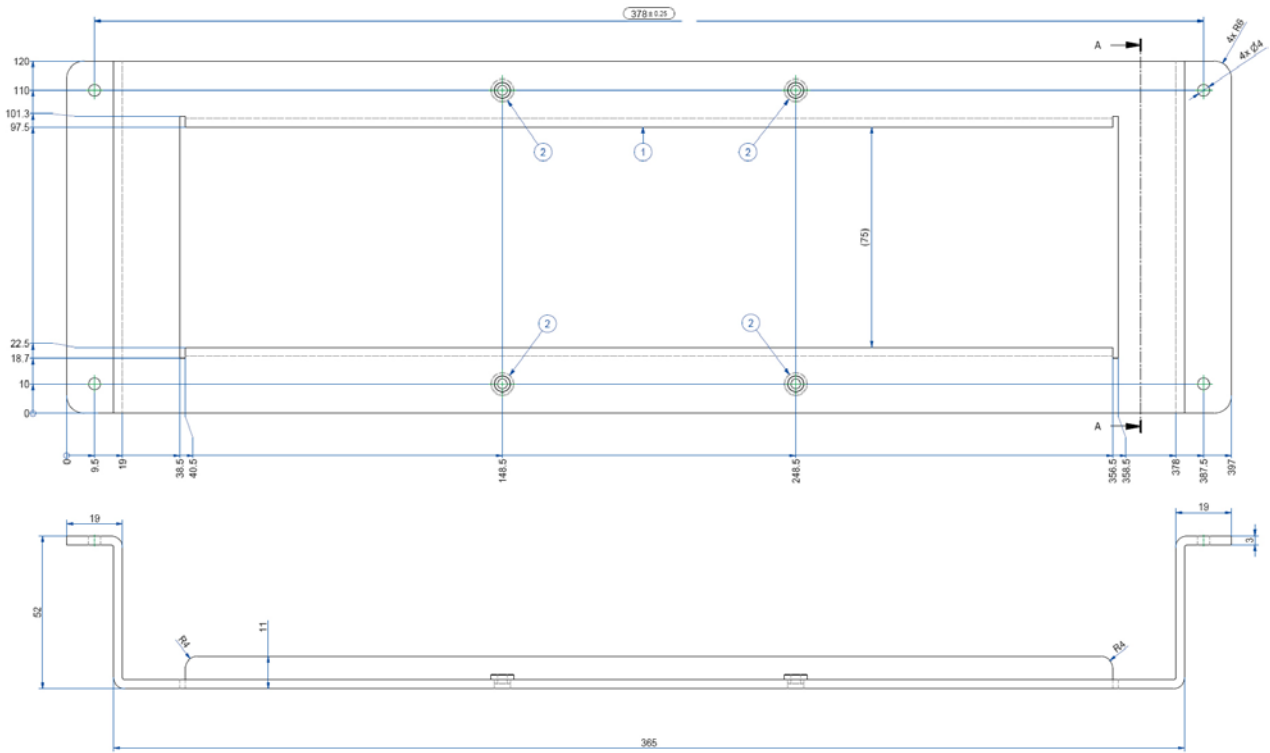

Fig. 39: Rear and bottom view of the mounting plate VESA® 75/100 for MC 3W 156

7.7. Installed SBC

Your MC 3/MC 3W system is equipped with the HMI Single Board Computer based on Intel® Atom™ CPU.

7.8. DC Power Connection

The MC 3/MC 3W system can be connected to a DC power source via a DC power cable (only the Phoenix power plug terminal is included).

7.8.1. DC Power Connector

The MC 3 is delivered with the DC power plug terminal (3-pin Phoenix connector). For DC connection prepare the connecting wires using the supplied Phoenix plug terminal.



The length of the DC connecting wires may not exceed 10 m.

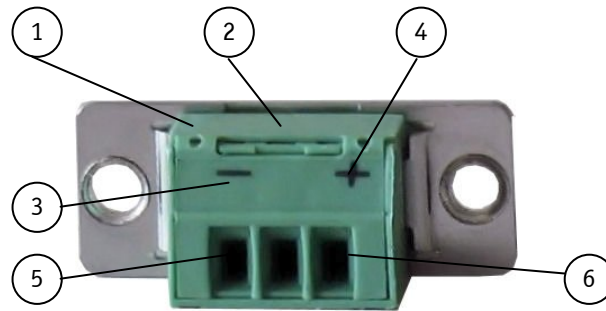

Fig. 40: Phoenix power plug terminal with "plus" and "minus" marking (MC 3 104/156/170)

- | | |
|--|---|
| 1 3-pin Phoenix plug terminal | 4 Marking "plus" |
| 2 Cover over the slotted pan head screws | 5 Location for inserting the "minus" wire |
| 3 Marking "minus" | 6 Location for inserting the "plus" wire |

1. Cut the required length two isolated wires [AWG18 (\varnothing up to 1 mm²)] and strip each end 5 –7 mm.
2. Twist the striped wire-ends and tin it with solder.
3. Open the cover to have access to the slotted pan head screws.
4. Loosen the two slotted pan head screws (that correspond to the marked location "+" and "-" of the DC plug terminal) far enough so that you can insert the end of the prepared wires.
5. Insert the wires into the corresponding clamp of the Phoenix plug terminal. Make sure that you have the right polarity of the connection (refer to Fig. 40).
6. Fasten the screws to secure the wires into the clamps of the plug terminal.
7. Close the cover.



The second end of each wire will be prepared as required for the connection to the DC power supply.

7.9. Accessing Internal Components

This section contains important information that you must read before accessing the internal components. You must follow these procedures properly when handling any board components of the system.



Before removing the cover of the MC 3/MC 3W in order to gain access to the internal components, the system must be powered-down and the power cord has to be disconnected from the power source.

The system may only be opened in accordance with the description in this user's guide for:

- Configuration of the RS422/RS485 interface.

These procedures have to be carried-out only by qualified specialist personnel.

It is not allowed to operate the system without installed cover.



Please observe the safety instruction for handling assemblies with static sensitive device.

Failure to take heed of this warning instruction can result in damage to the device.



Please observe the warning label "Hot Surface" shown in Fig. 36 and Fig. 37 on the rear side of the cabinet. The MC 3/MC3W chassis may be hot during operation and should not be touched without taking care.

The material on bottom surface of the enclosure interior where the MC 3/MC 3W is to be mounted, shall keep at least flammability class UL 94-5VB. Don't put flammable materials under the device.

7.9.1. Configuration of the RS422/RS485 Port (MC 3 104/121/150/170, MC 3W 156)

In order to change the factory configuration of the RS422/RS485 port [factory settings: refer to the grey highlighted settings of the SW1 (DIP1-DIP8) (Table 1, Table 2 and Table 3)] proceed as follows:



The new port configuration has to be set before the system is installed on a panel or into an industrial cabinet. The system must be disconnected from the power source. Disconnect all peripherals. Before you begin, ensure that you have a clean, flat and ESD-safe surface to work on.

1. Close all applications, shut down the system properly and disconnect the power cord from the power source. Disconnect all peripherals.
2. The MC 3/MC 3W system should lay on a flat, clean surface with the front panel downwards. (Make sure that the display surface is protected against scratching and damage).
3. a) For MC 3 104/121/150/170: Unscrew the 5x screws that secure the cover (refer to *pos. 5*, Fig. 31 and Fig. 37). Put the screws aside for later use. Lift up the cover and put it aside.
b) For MC 3W 156: Unscrew the 5x screws that secure the cover (refer to *pos. 5*, Fig. 30, Fig. 32, Fig. 33 and Fig. 36). Put the screws aside for later use. Lift up the cover and put it aside.
4. Locate the DIP switches inside the unit (refer to Fig. 41).

5. By use of an insulated thin tool (e. g. screwdriver or a stylus) set the DIP switches to the up (for ON) or down (for OFF) position corresponding the needed port configuration (refer to the Table 1, Table 2 and Table 3).

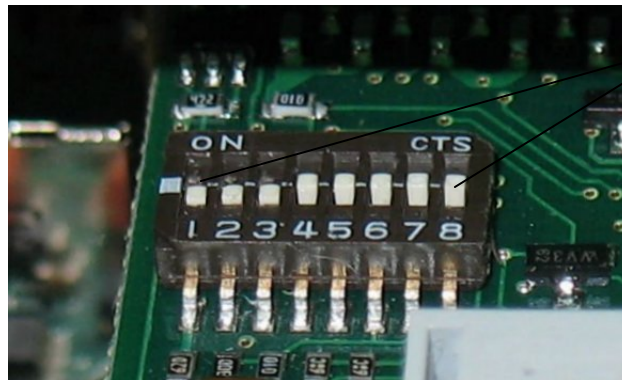

Fig. 41: DIP1-DIP8 switches (shown with factory settings)

6. Replace carefully the cover to the system and screw it on with the retained screws.
7. Tighten the retained screws when the cover is firmly in place.

7.10. Getting started

The MC 3/MC 3W system is designed to be powered from a DC power source via a DC power cable (not included). In order to use an AC power source as main power source, an AC/DC adapter (not included) can be ordered.

7.10.1. Connecting to Power



- ❑ Before using your system, you should first become familiar with the system components and check that everything is connected properly.
- ❑ It is recommended that the last cable attached to the system should be the power cable!

7.10.1.1. Connecting to DC Power Source

The MC 3/MC 3W system will be connected to DC power source using the DC power cable confectioned as described in the 7.8.1 "DC Power Connector" chapter.

MC 3 104/121/150/170, MC 3W 156

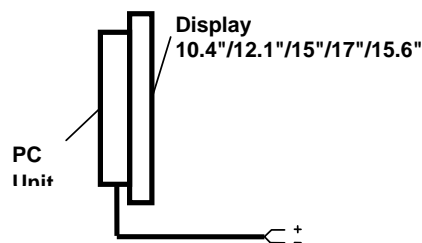

Fig. 42: Connecting to DC power source

1. Connect the 3-pin DC power connector of the DC power cable to the appropriate DC power connector (refer to pos. 2, Fig. 25 and Fig. 26) of the MC 3 system. The DC power connector of the system is on the rear bottom side and is labeled "-24V DC+". Make sure the connector is securely locked in place.
2. Ensure that the DC power source is switched off via an isolating switch, in order to ensure that no power is flowing from the external power source during the connection procedure.
3. Connect the other end of the DC power cable to the terminals of the 24V DC power source. Ensure that the power connections maintain the proper polarity.
4. Switch on the isolating switch in order to apply voltage to the terminals of the power source (cable wires).



Behaviour of the MC 3/MC 3W systems

When turning on power to the system via the isolating switch, the MC 3 system will immediately boot-up the installed operating system.



Hints for DC power connection:

The DC power source should be able to be switched off and on via an isolating switch.

The unit is only completely disconnected from the DC main power source, when the DC power cord is disconnected either from the power source or the unit. Therefore, the DC power cord and its connectors must always remain easily accessible.

7.11. Operating System and Hardware Component Drivers

Your MC 3/MC 3W system can be supplied either with or without a pre-installed operating system.

If you have ordered your system with a pre-installed operating system, all drivers are installed in accordance with the system configuration ordered (optional hardware components). Your system is fully operational at the first start-up.

If you have ordered a MC 3/MC 3W system without a pre-installed operating system, because you want to install it yourself, please pay attention to the following information:



You can download the relevant information about operating systems, boot devices and drivers for the installed hardware from our web site at www.kontron.com by selecting the product name (designation).

The corresponding driver (depending on the installed operating system) for the touch screen controller is available on our website by selecting the "Downloads" tab of the Micro Client 3 product page.

7.12. MC 3/MC 3W System Mounting to a Subframe or Panel

The system configurations come in the delivering status without assembled mounting clamps and the corresponding Allen Screws. In order to mount the system to a subframe or panel, refer to Fig. 43 or Fig. 44, depending on the system ordered.

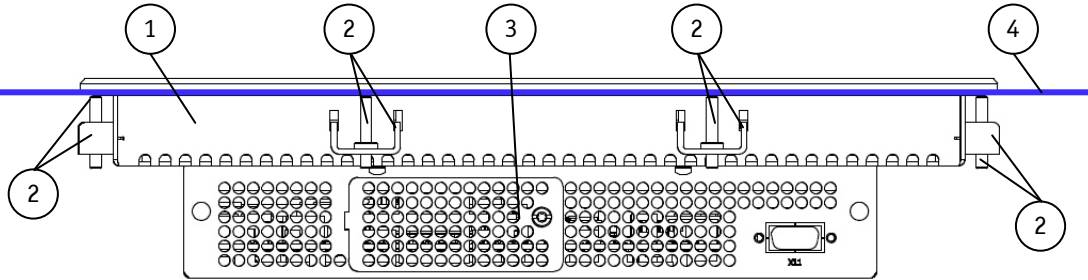

Fig. 43: Detail with mounting clamps and a subframe
(shown with a MC 3 104 system)

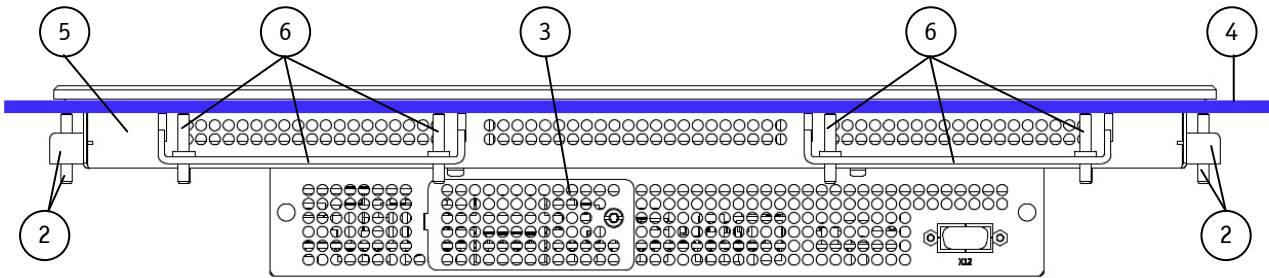

Fig. 44: Detail with mounting clamps and a subframe
(shown with a MC 3W 156 system)

Legend for Fig. 43 and Fig. 44:

- | | |
|---|--|
| 1 Enclosure of the 10.4" display | 4 Example of subframe for system installation |
| 2 Mounting clamp with 1x screw (used for mounting of MC 3 104/ MC 3W 156 into a subframe/panel) | 5 Enclosure of the 15.6" display |
| 3 Cover of CompactFlash™/SD card slot | 6 Mounting clamp with 2 screws (used for mounting of the MC 3 121/150/170 and MC 3W 156 into a subframe/panel) |



In order to ensure IP65 front sealing against dust and water, **mount the system on a non-textured surface**. Before you install the MC 3 system into a panel or a subframe for industrial cabinet, verify the perfect condition of the seal at the rear of the front plate. The seal has to be in place without injury/defects and dirt.



Please observe the warning label "Hot Surface" shown in Fig. 36 and Fig. 37 on the rear side of the cabinet. The MC 3/MC3W chassis may be hot during operation and should not be touched without taking care.

The material on bottom surface of the enclosure interior where the MC 3/MC 3W is to be mounted, shall keep at least flammability class UL 94-5VB. Don't put flammable materials under the device.

The mounting clamps with screws (supplied), allow the easy and fast mounting of the MC 3 into an instrument panel or wall panel.







Dimension for:	Micro Client 3				Micro Client 3W
	104	121	150	170	156
Rear side enclosure (W x H x D) [mm]	295x234x63.75	324.5x263.5x62.5	406.8x311.4x65.5	416x356x64.5	398x249x63.5
Cut-Out for Mounting into a Panel (W x H)	297x236 [mm] 11.69"x9.29"	327x266 [mm] 12.87"x10.4"	409x313 [mm] 16.10"x12.32"	420x358 [mm] 16.53"x 14.09"	400x251 [mm] 14.75"x9.88"
Requirements for Mounting					
Metal mounting panel thickness for proper mounting	1.5 – 6.5 [mm] 0.06" - 0.26"	1.5 – 5.5 [mm] 0.06" - 0.22"	1.5 - 7 [mm] 0.06" - 0.28"	1.5 – 9.5 [mm] 0.06" - 0.37"	1.5 - 7 [mm] 0.06" - 0.28"
Used clamps with screws for mounting the MC 3 104/156/170 device to a subframe or panel	8x 	6x 	8x 	8x 	4x  4x 
Required Tool	Allen Wrench 2 mm				
Proper Torque	Tighten the screws with a torque of 0.5 Nm				
Mounting Position	Ensure the vertical and horizontal alignment of the system.				

Table 7: Requirements for the MC 3 104/121/150/170 and MC 3W 156 mounting into a subframe/panel

To mount the system to a subframe or to a panel, follow these steps:

1. Assemble the mounting clamp/s with the Allen Screw/s (included).
2. Depending on the dimension of the display enclosure of your system, cut a hole in the panel/subframe (refer to Table 7 for the panel cut-out dimensions). The panel where you intend to attach the system must be accessible from both front and rear side.
3. The system must be turned off and disconnected from the power source and peripherals.
4. Insert the system into the panel cut-out from the panel/subframe front.
5. In order to ensure the protection class IP65 on the front side in the installed condition, the contact surface with the seal must be clean and flush.
6. Ensure the vertical and horizontal alignment of the system.
Fasten the MC 3/MC 3W system from the rear using the mounting clamps.
5. Hook the mounting clamps with screws from the rear side of the panel into the corresponding pairs of slots of the enclosure.
7. The system must be attached firmly with the screws. Tighten the screws with a torque of 0.5 Nm (refer to Table 7 for the mounting requirements).

8. Maintenance and Prevention

Kontron Europe systems require minimal maintenance and care to keep them operating correctly.

- Occasionally wipe the system with a soft dry cloth.
- You should only remove persistent dirt by use of a soft, slightly damp cloth (use only a mild detergent).
- For the touch screen cleaning refer to the chapter 7.1.4. "Touch Screen Care and Cleaning".

9. Technical Data

Features for		Micro Client 3				Micro Client 3W
		104	121	150	170	156
TFT LCD Display	Screen size	10.4"	12.1"	15"	17"	15.6"
	Resolution (H x V) [pixel]	800 x 600 (SVGA)	1024 x 768 (XGA)	1024 x 768 (XGA)	1280 x 1024 (SXGA)	1366 x 768 (WXGA)
	Colour depth	262k/16.2M	262k/16.2M	262k/16.2M	16.7 M	16.7 M
	Backlight	LED	LED	LED	LED	LED
	Brightness cd/m ²	450	500	400	350	300
	Contrast ratio	700:1	700:1	700:1	1000:1	500:1
Touch Screen	5 wire resistive analog				PCAP capacitive	
SBC with Intel® Atom™ Processor D2550 1.86 GHz	☑				☑	
Memory: up to 4 GB (Socket 1x 204-pin DDR3)	☑				☑	
Power Button	☑				☑	
Power LED	☑				☑	
HDD LED	☑				☑	
USB Port (on the front side) with elastic captive rubber coat	1x				Not available	
Interfaces (on the bottom side)						
USB 2.0	2x				2x	
USB 3.0	2x				2x	
Ethernet (10/100/1000Mbps)	2x				2x	
DisplayPort	1x				1x	
Serial Port RS232 (COM1)	1x				1x	
Socket for PCIe Mini card (on board)	1x				1x	
Socket for Mini SATA Card (on board)	1x				1x	
CF and SD Card Reader (Option) (internal factory installed)	1x				1x	

The table is continued on the next page.

Features for	Micro Client 3				Micro Client 3W
	104	121	150	170	156
Storage Media (Option) but one always factory installed					
2.5" HDD* or 2.5" SSD	1x				1x
mSATA SSD	1x				1x
CF card, ext. accessible (only if CF card reader installed)	1x				1x
SD card , ext. accessible (only if CF card reader installed)	1x				1x
SIM card, int. accessible (only if CF card reader installed)	1x				1x
Extension Slots for optional Interfaces	2x	3x	3x	3x	3x
Optional Interfaces:					
Serial Port RS422/485* RS422 (default) [configurable via internal DIP Switch (SW1)] or Serial Port (COM2) (RS232) or CAN-BUS* Port	up to 2x	up to 3x	up to 3x	up to 3x	up to 3x
Protection Class (front side) IP 65 according IEC 60529	<input checked="" type="checkbox"/>				<input checked="" type="checkbox"/>
BIOS	AMI BIOS				
Operating System	Refer to the Datasheet for Micro Client 3 on our Website www.kontron.com				
DC Power Connector (3-Pin), (on the rear bottom side)	1x				1x
DC Power Terminal (3-Pin)	1x				1x
Mounting Clamps (for one screw)	8x	---	---	---	4x
Mounting Clamps (for 2 screws)	---	6x	8x	8x	4x
Screw for Mounting Clamps	8x	12x	16x	16x	12x

The table is continued on the next page.

(*see "Operating Temperature" in chapter 9.2 "Environmental Specifications".)

Features for	Micro Client 3				Micro Client 3W
	104	121	150	170	156
Optional Parts					
VESA® 100 compliant Mounting Plate	<input checked="" type="checkbox"/>	<input checked="" type="checkbox"/>	<input checked="" type="checkbox"/>	<input checked="" type="checkbox"/>	<input checked="" type="checkbox"/>
CF Card (Type II)	<input checked="" type="checkbox"/>	<input checked="" type="checkbox"/>	<input checked="" type="checkbox"/>	<input checked="" type="checkbox"/>	<input checked="" type="checkbox"/>
2.5" SATA HDD	<input checked="" type="checkbox"/>	<input checked="" type="checkbox"/>	<input checked="" type="checkbox"/>	<input checked="" type="checkbox"/>	<input checked="" type="checkbox"/>

9.1. Electrical Specifications

9.1.1. Electrical Specifications for MC 3 104/121/150/170/3W 156 System

System Type	Product Designation	Input
Micro Client 3 (MC 3)	MC 3 104	24VDC (+/- 20% = 18 – 30VDC) 0.7A _{Nom} (~20W)
	MC 3 121	24VDC (+/- 20% = 18 – 30VDC) 0.8A _{Nom} (~22W)
	MC 3 150	24VDC (+/- 20% = 18 – 30VDC) 0.95A _{Nom} (~30W)
	MC 3 170	24VDC (+/- 20% = 18 – 30VDC) 1.8A _{Nom} (~45W)
	MC 3W 156	24VDC (+/- 20% = 18 – 30VDC) 1.05A _{Nom} (~32W)

9.2. Environmental Specifications

Thermal Management	passive cooling (for CPU and system)
Operating Temperature	0 ... +50 °C (32 ... 122 °F) for MC 3 104/121/150/170 0 ... +55 °C (32 ... 131 °F) for MC 3W 156 (*options : max. 50 °C)
Storage/Transit Temperature	-10 ... +60 °C (14 ... 140 °F)
Operating Rel. Humidity	10% to 90% @ 35 °C, non-condensing
Storage/Transit Rel. Humidity	10% to 90% @ 35 °C, non-condensing
Operating Altitude	Up to 2,000 m (6,600 ft)
Storage / Transit Altitude	Up to 4,600 m (15,000 ft)
Operating Shock	15 G, 11 ms duration, half-sinus
Storage / Transit Shock	30 G, 11 ms duration, half-sinus
Operating Vibration	10–500 Hz: 1.0 G/3axis
Storage / Transit Vibration	10–500 Hz: 2.0 G/3axis
Protection Class	IP65 (Front Panel Side), IP20 (Rear)

9.3. Mechanical Specifications

9.3.1. Dimensions for MC 3 104/121/150/170 and MC 3W 156

Dimension for	MC 3 104	MC 3 121	MC 3 150	MC 3 170	MC 3W 156
Height	257 mm (10.118")	286 mm (11.260")	334 mm (13.150")	379 mm (14.921")	270 mm (10.630")
Width	318 mm (12.520")	347 mm (13.661")	429 mm (16.890")	441 mm (17.362")	419 mm (16.496")
Depth (total)	69 mm (2.71")	67.5 mm (2.658")	70.5 mm (2.758")	69.5 mm (2.697")	68.5 mm (2.204")
Depth (without front plate)	64 mm (2.51")	62.5 mm (2.461")	65.5 mm (2.579")	64.5 mm (2.539")	63.5 mm (2.500")
Weight	3.5 kg (7.716 lbs)	4.5 kg (9.921 lbs)	6.5 kg (14.33 lbs)	7.5 kg (16.535 lbs)	4.5 kg (9.921 lbs)

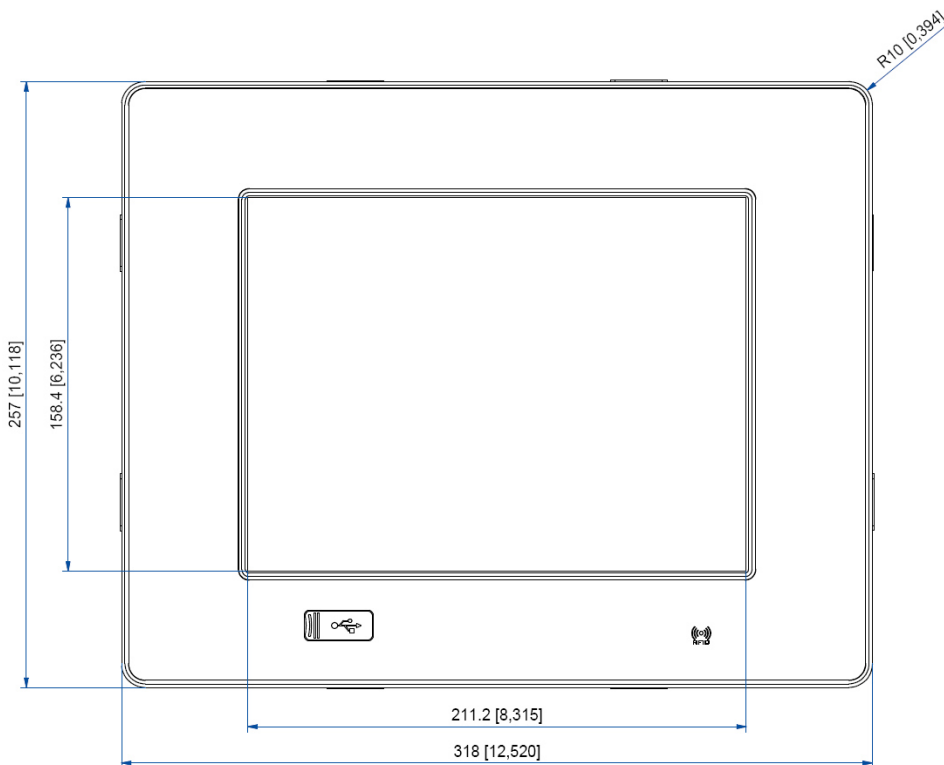

Fig. 45: Frontal view of the MC 3 104 system

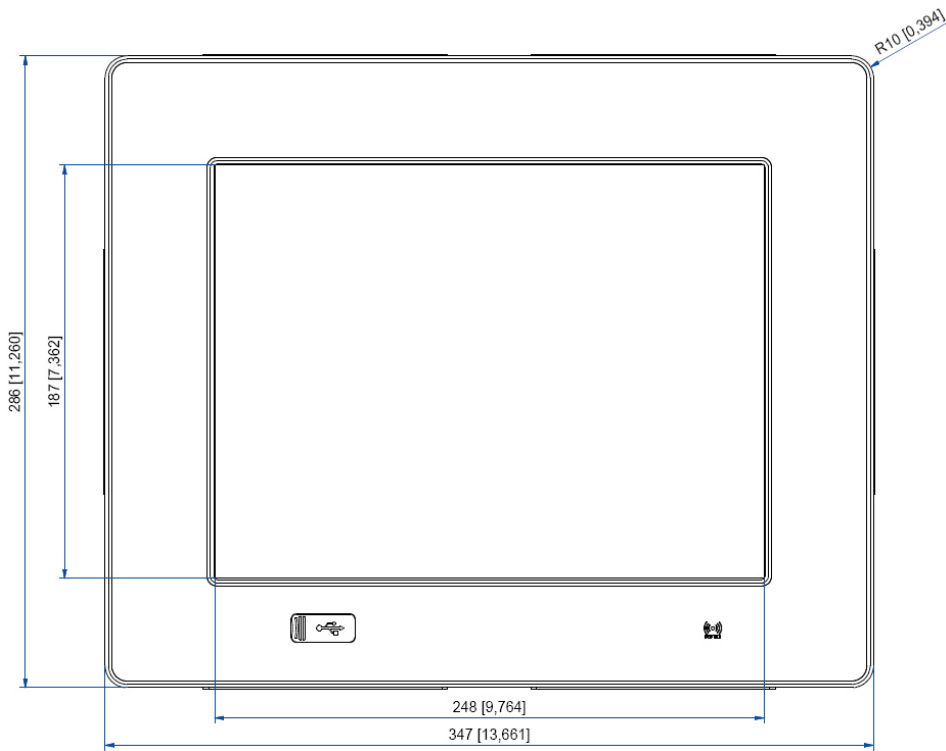

Fig. 46: Frontal view of the MC 3 121 system

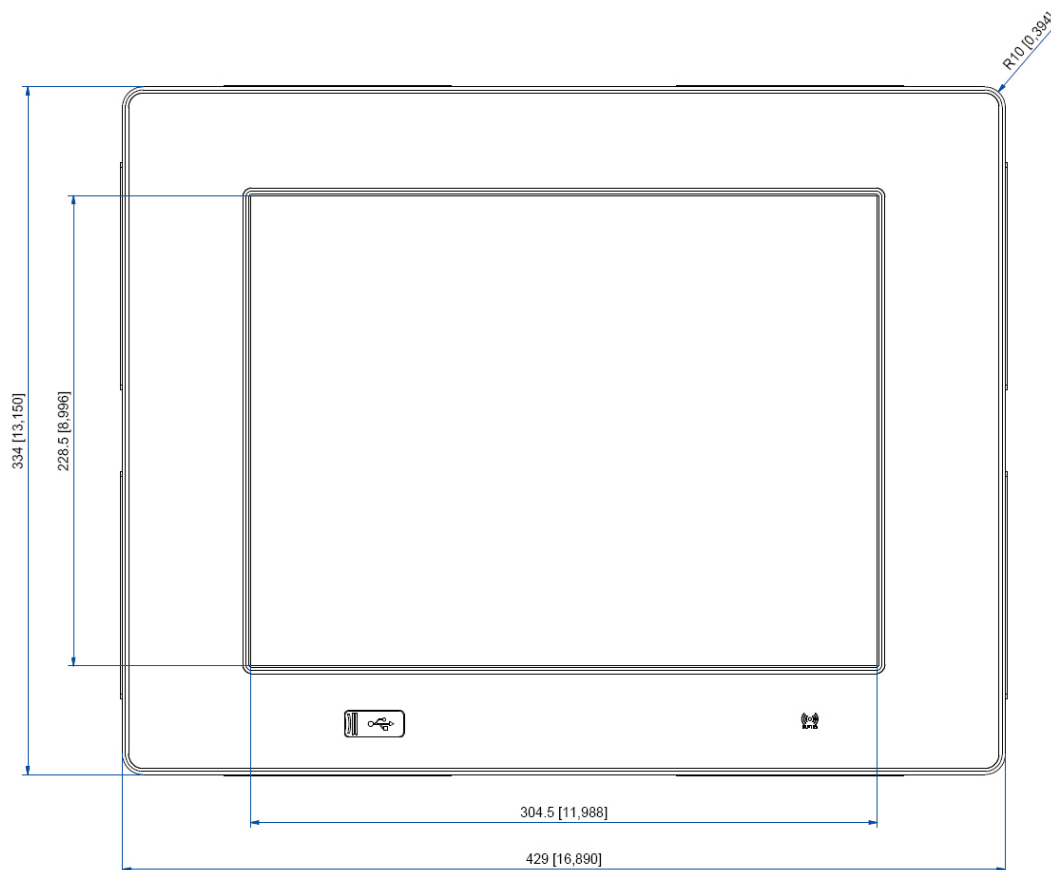

Fig. 47: Frontal view of the MC 3 150 system

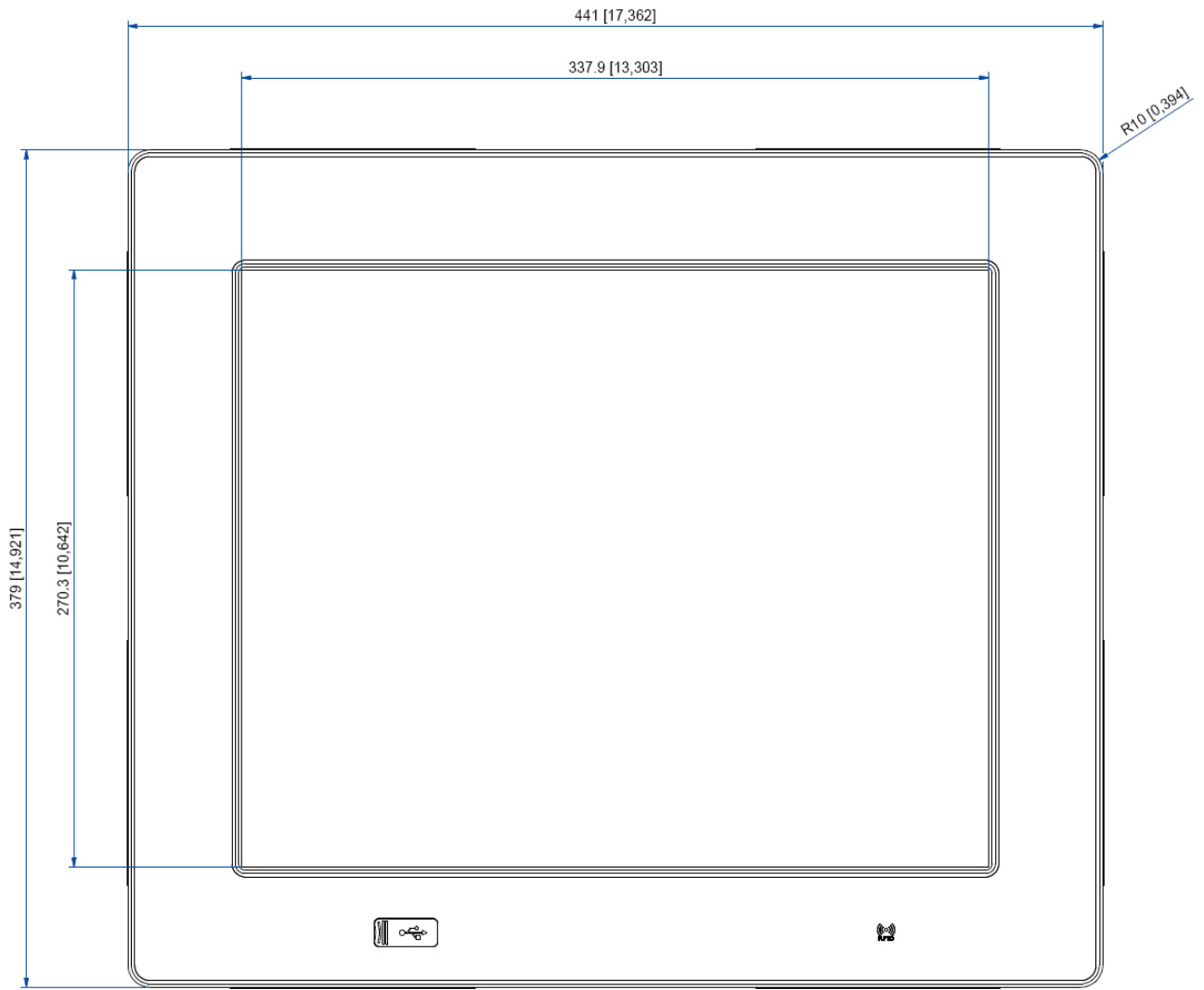

Fig. 48: Frontal view of the MC 3 170 system

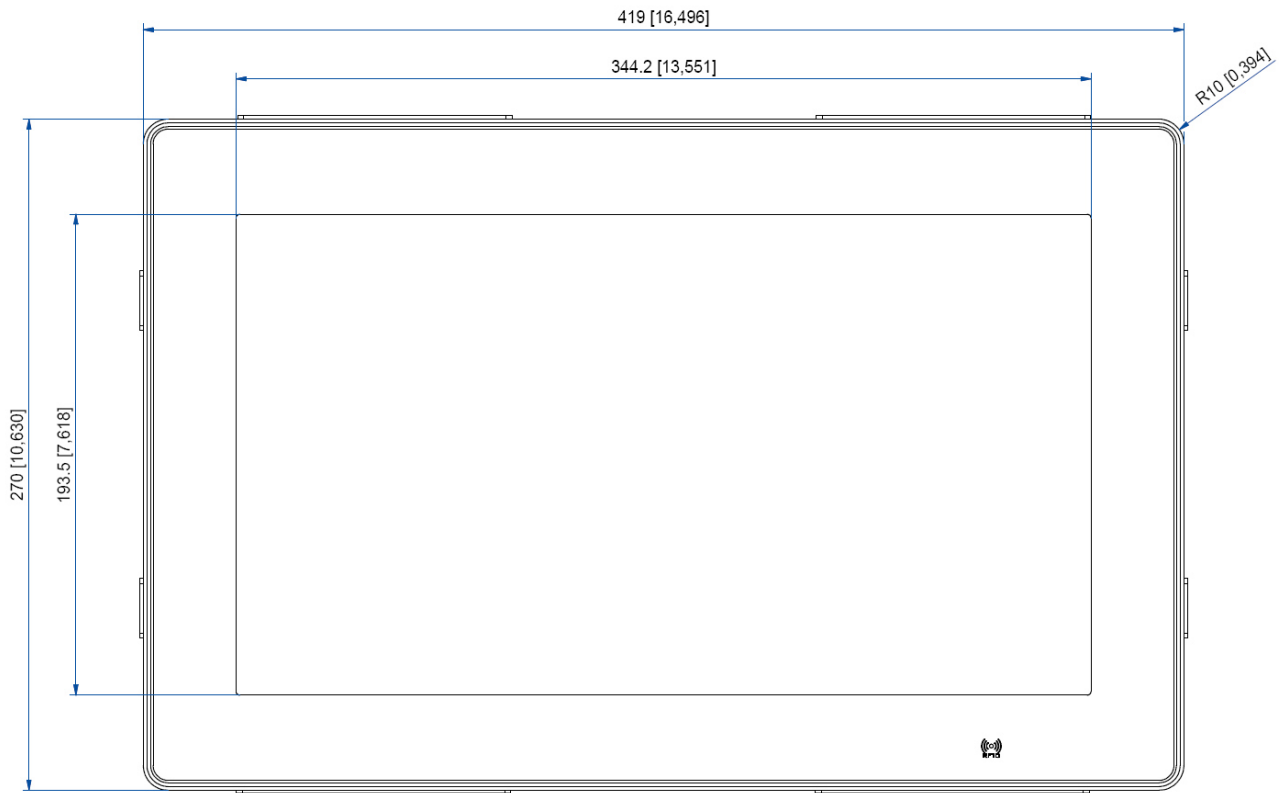
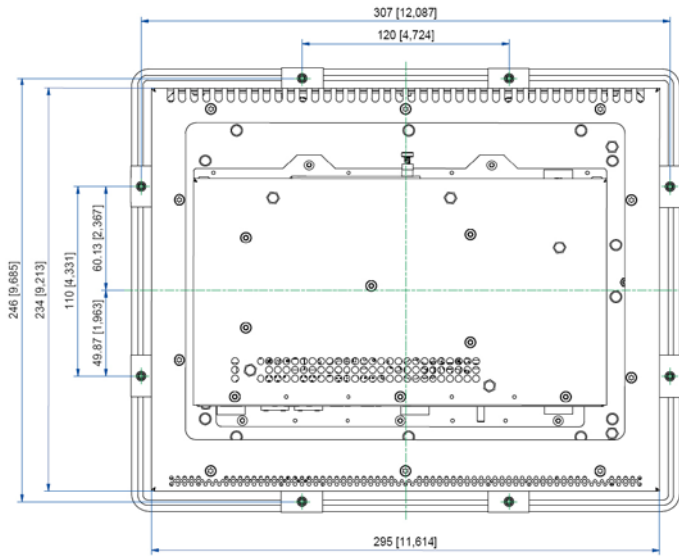
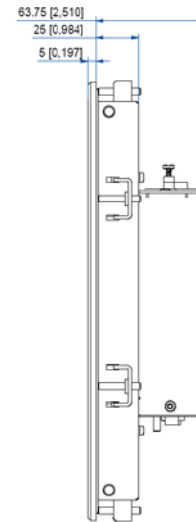

Fig. 49: Frontal view of the MC 3W 156 system

MC 3 104 - rear view



MC 3 104 – right side view



MC 3 121 - rear view

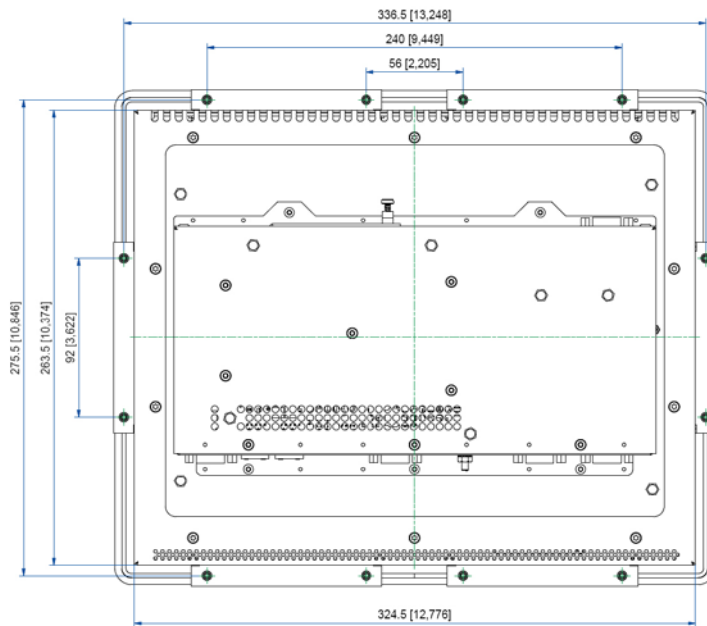

MC 3 121 – right side view

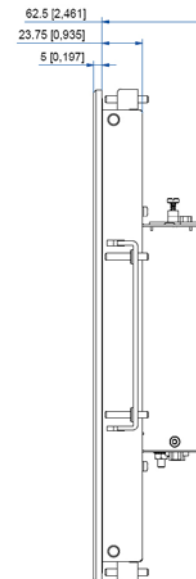

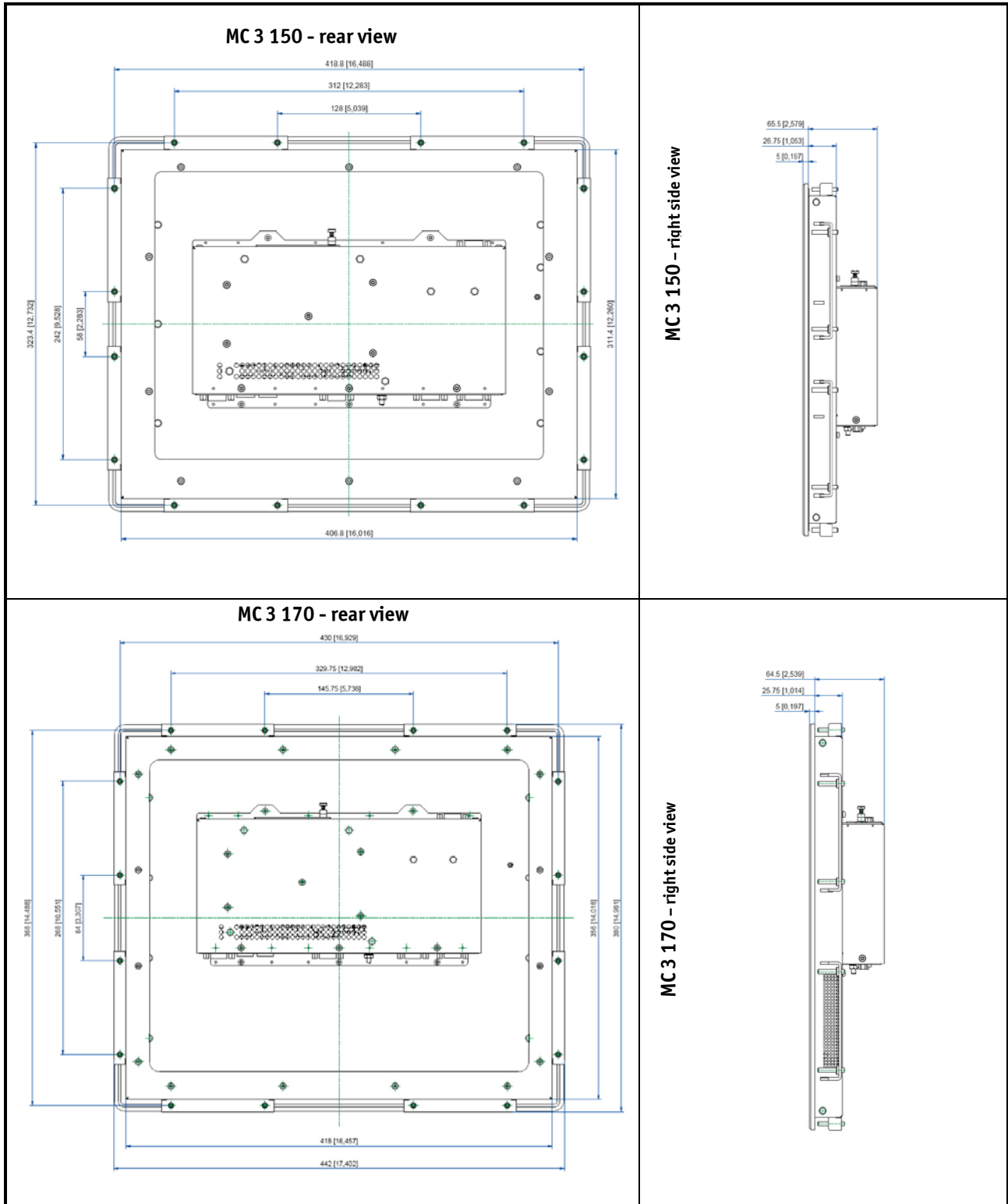

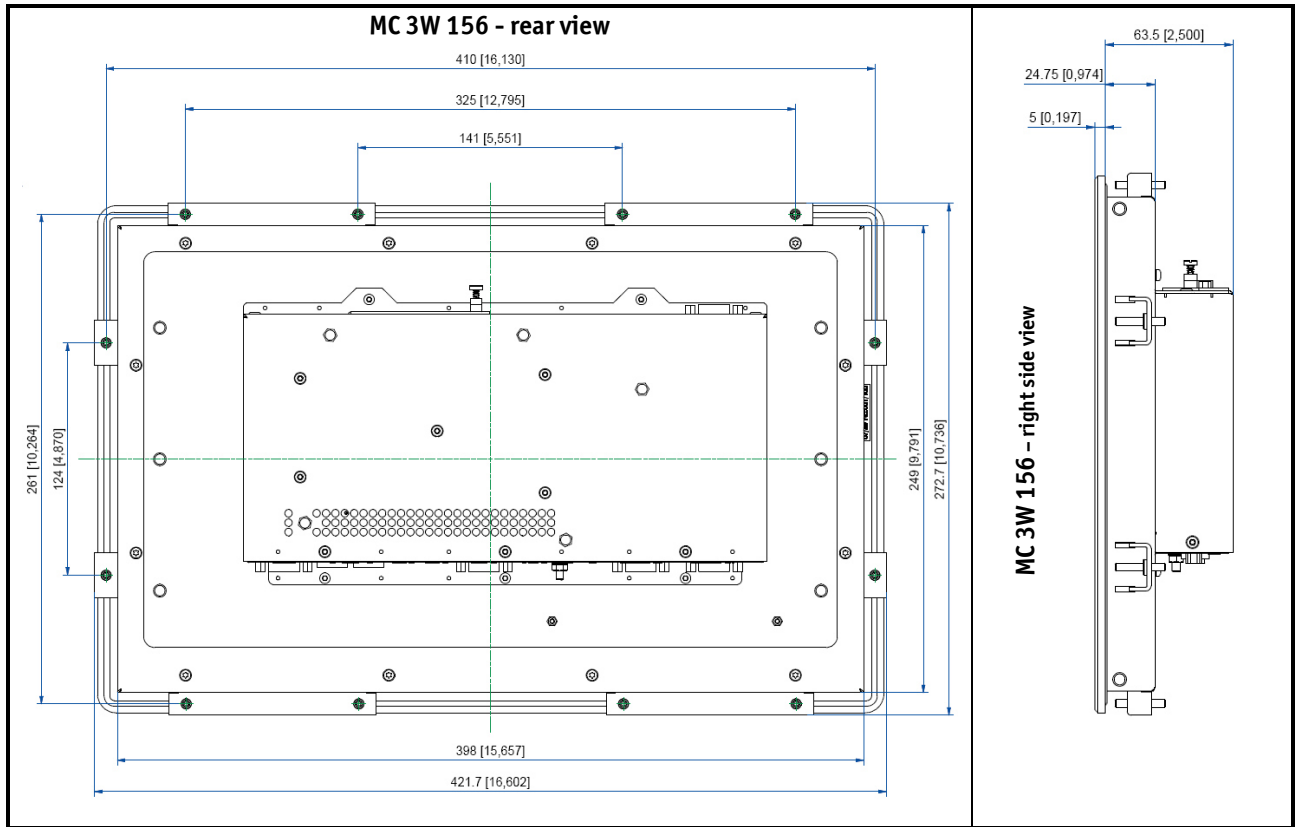

9.4. CE Directives and Standards

CE Directives	
Low Voltage Directive (Electrical Safety)	2006/95/EC
EMC Directive	2004/108/EC
RoHS II Directives	2011/65/EU

Electrical Safety	Standards
EUROPE	EN 60950-1: 2006
USA	UL 60950-1:2006 cULus Listed
CB Scheme	IEC 60950-1:2005 CB Certificate

EMC	Standards for MC 3 104/121/150/170	Standards for MC 3W 156
EUROPE	<p>Generic standards - Emission standard for residential, commercial and light-industrial environments (Emission): EN 61000-6-3: 2007 +A1:2010</p> <p>Emission of Information technology equipment – Radio disturbance characteristics – Limits and methods of measurement: EN 55022:2010 Class B</p> <p>ITE - Immunity characteristics - Limits and methods of measurement EN55024: 2010</p> <p>Generic standards - Immunity for industrial environments (Immunity): EN 61000-6-2: 2005</p>	<p>Generic standards - Emission standard for residential, commercial and light-industrial environments (Emission): EN 61000-6-3: 2007 +A1:2010</p> <p>Emission of Information technology equipment – Radio disturbance characteristics – Limits and methods of measurement: EN 55022:2010 Class B</p> <p>ITE - Immunity characteristics - Limits and methods of measurement EN55024: 2010</p> <p>Generic standards - Immunity for industrial environments (Immunity): EN 61000-6-2: 2005</p>
U.S.A.	FCC 47 CFR Part 15, Class A	FCC 47 CFR Part 15, Class A
Canada	ICES-003 class A	ICES-003 class A

10. Standard Interfaces – Pin Assignments

Low-active signals are indicated by a minus sign.

10.1.1. Power Connector

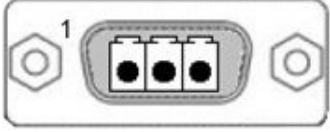
Pin	Signal Name	3-pin POWER SUBCON (male)
1	0V input (-24 VDC polarity on the unit)	
2	NC	
3	+24 VDC (input)	

10.1.2. Serial interface COM (RS232)

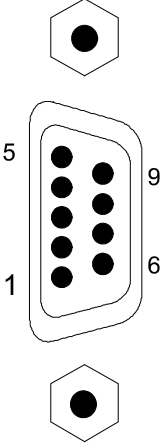
Pin	Signal Name	9-pin D-SUB Connector (male)
1	DCD (Data Carrier Detect)	
2	RXD (Receive Data)	
3	TXD (Transmit Data)	
4	DTR (Data Terminal Ready)	
5	GND (Signal Ground)	
6	DSR (Data Set Ready)	
7	RTS (Request to Send)	
8	CTS (Clear to Send)	
9	RI (Ring Indicator)	

10.1.3. Serial Port (RS422/RS485) configured as RS422 (4-Channel Mode)

Refer to the chapter 7.3.1 “RS422/RS485 Serial Interface Connector/s”, Table 1, Table 2 and Table 3.

Pin	Signal Name	9-pin D-SUB Connector (female)
1	TxD- (Transmit Data-)	
2	RxD+ (Receive Data+)	
3	TxD+ (Transmit Data+)	
4	RxD- (Receive Data-)	
5	GND (Signal Ground)	
6	RTS- (Request to Send-)	
7	RTS+ (Request to Send+)	
8	CTS+ (Clear to Send+)	
9	CTS- (Clear to Send-)	

10.1.4. Serial Port (RS422/RS485) configured as RS485 (4-Wire Mode), full duplex, (Bus-Master)

Refer to the chapter 7.3.1 “RS422/RS485 Serial Interface Connector/s”, Table 1, Table 2 and Table 3.

Pin	Signal Name	9-pin D-SUB Connector (female)
1	TxD- (Transmit Data-)	
2	RxD (Receive Data+)	
3	TxD+ (Transmit Data+)	
4	RxD- (Receive Data-)	
5	GND (Signal Ground)	
6	NC	
7	NC	
8	NC	
9	NC	

10.1.5. Serial Port (RS422/RS485) configured as RS485 (2-Wire Mode), half duplex

Refer to the chapter 7.3.1 “RS422/RS485 Serial Interface Connector/s”, Table 1, Table 2 and Table 3.

Pin	Signal Name	9-pin D-SUB Connector (female)
1	Data-	
2	NC	
3	Data+	
4	NC	
5	GND (Signal Ground)	
6	NC	
7	NC	
8	NC	
9	NC	

10.1.6. CAN Connector

Refer to the chapter 7.3.2 “DIP-Switch Settings (SW1) for LPCtoCAN Adapter”.

Pin	Signal Name	9-pin D-SUB Connector (male)
1	NC	
2	CANL (galavic separated)	
3	CANOV (galavic separated)	
4	NC	
5	NC	
6	NC	
7	CANH (galavic separated)	
8	NC	
9	NC	
case	GND	

10.1.7. DP Connector (DisplayPort)

Pin	Signal Name	20-pin DP Connector
1	ML LANE 0+	
2	GND (ML LANE 0)	
3	ML LANE 0-	
4	ML LANE 1+	
5	GND (ML LANE 1)	
6	ML LANE 1-	
7	ML LANE 2+	
8	GND (ML LANE 2)	
9	ML LANE 2-	
10	ML LANE 3+	
11	GND (ML LANE 3)	
12	ML LANE 3-	
13	AUX_SEL#	
14	Pull-down to GND	
15	AUX CH+	
16	GND (AUX CH)	
17	AUX CH-	
18	Hotplug	
19	GND (GND_DDC)	
20	+3.3V (DDC EEPROM power) 500mA fused	

10.1.8. USB Port

Pin	Signal Name	4-pin USB Connector Type A Version 2.0
1	VCC	
2	Data-	
3	Data+	
4	GND	

11. Technical Support

For technical support, please contact our Technical Support department:

e-mail: support@kontron.com

Web: <http://www.kontron.com/support>

Make sure you have the following information on hand when you call:

- the unit part id number (PN),
- the serial number (SN) of the unit; the serial number can be found on the type label, placed on the rear side of the system.

Be ready to explain the nature of your problem to the service technician.

If you have questions about Kontron Europe or our products and services, you can reach us by e-mail or at: www.kontron.com.

11.1. Returning Defective Merchandise

Please follow these steps before you return any merchandise to Kontron Europe:

1. Download the corresponding form for returning a device with an RMA No. [RMA (Return of Material Authorization)] from our website www.kontron.com / Support / RMA Information.
You also can contact our Customer Service department to obtain an RMA No.:
e-Mail: service@kontron.com
2. Ensure that you have received an RMA number from Kontron Customer Services before returning any device. Write this number clearly on the outside of the package.
3. Describe the fault that has occurred.
4. Please provide the name and telephone number of a person we can contact to obtain more information, where necessary. Where possible, please enclose all the necessary customs documents and invoices.
5. When returning a device:
 - Pack it securely in its original box.
 - Enclose a copy of the RMA form with the consignment.

Corporate Offices

Europe, Middle East & Africa	North America	Asia Pacific
Oskar-von-Miller-Str. 1 85386 Eching/Munich Germany Tel.: +49 (0)8165/ 77 777 Fax: +49 (0)8165/ 77 219 info@kontron.com	14118 Stowe Drive Poway, CA 92064-7147 USA Tel.: +1 888 294 4558 Fax: +1 858 677 0898 info@us.kontron.com	17 Building,Block #1,ABP. 188 Southern West 4th Ring Beijing 100070, P.R.China Tel.: + 86 10 63751188 Fax: + 86 10 83682438 info@kontron.cn