

» Instructions for Use «



WARNING!

For a full understanding of the performance characteristics of this device, the user should carefully read this "Instructions for Use" before using of the device.

Medi Client IIA

Instructions for use (Version 1.03)

0-0096-6791

This page is intentionally left blank.

1. Table of Contents

1. Table of Contents	1
1.1. Table of Figures.....	2
2. Introduction	4
3. Symbols used in the Instructions for Use	5
3.1. Symbols used on the Device.....	5
4. Important Instructions	6
4.1. Note on the Warranty	6
4.2. Exclusion of Accident Liability Obligation.....	6
4.3. Liability Limitation / Exemption from the Warranty Obligation	6
5. General Safety Instructions	7
5.1. Instructions for the CMOS (Lithium) Battery	9
5.2. Electrostatic Discharge (ESD)	9
5.2.1. Grounding Methods.....	9
5.3. Electromagnetic Compatibility (EN 60650-1)	10
5.3.1. FCC Statement (USA)	10
5.3.2. EMC-Compliance for Canada	10
5.3.3. Electromagnetic Compatibility for EU.....	10
5.4. Electromagnetic Compatibility (EN60601-1-2)	10
5.4.1. Compliant Accessories	14
6. Scope of Delivery	15
6.1. Optional Parts.....	15
6.2. Labels and Product Identification	16
7. Product Description	17
7.1. Front Side View	19
7.1.1. Power Button on the Front Side	19
7.1.2. Power LED on the Front Side	20
7.1.3. Display (10.4"/15") with Touch Screen.....	20
7.2. Bottom View.....	23
7.2.1. Power and Reset	23
7.2.2. Power Button on the Interface Side	24
7.2.3. Power LED on the Interface Side and Error Codes.....	24
7.2.4. Storage Drive Activity LED	25
7.2.5. Interfaces (Rear, Bottom Side of the System)	25
7.3. Top, Left and Right Side View	29
7.3.1. USB Interface Connector on the Left Side of the System	29
7.4. Rear View.....	30
7.5. Internal Storage Device	30
7.6. Mounting to an optional VESA® Mounting System	31
7.7. Getting started	32
7.7.1. Connecting to AC Power Source via the optional AC/DC Adapter	32
7.7.2. Connecting to DC Power Source (Option)	33
7.8. Operating System and Hardware Component Drivers	35
7.8.1. Hints for the Installation of the Hampshire® TSHARC™ Touch Screen Controller Driver.....	35

8. Maintenance and Prevention	36
8.1. Maintenance Intervals for the Lithium Battery.....	36
8.2. System Self Protection against Ambient Overheating.....	36
8.3. Care and Cleaning.....	37
8.4. Disinfection.....	37
8.4.1. Recommended surface-disinfectants:.....	37
9. Technical Data	38
9.1. Electrical Specifications.....	39
9.1.1. Electrical Specifications for Medi Client IIA System.....	39
9.1.2. Electrical Specifications for the Optional AC/DC Adapter.....	39
9.2. Environmental Specifications.....	39
9.3. Mechanical Specifications.....	40
9.3.1. Outline Dimensions for Medi Client IIA 104.....	40
9.3.2. Outline Dimensions for Medi Client IIA 150.....	42
9.4. CE Directives and Standards.....	44
10. Interfaces - Pin Assignments	45
10.1.1. Power Connector.....	45
10.1.2. USB Interfaces (USB).....	45
10.1.3. Serial Port RS232.....	45
10.1.4. Serial Port (RS422/RS485) configured as RS422 (4-Channel Mode).....	46
10.1.5. Serial Port (RS422/RS485) configured as RS485 (4-Wire Mode), full duplex, (Bus-Master).....	46
10.1.6. Serial Port (RS422/RS485) configured as RS485 (2-Wire Mode), half duplex.....	47
10.1.7. CAN Connector.....	47
10.1.8. VGA Port (VGA).....	48
11. Technical Support	49
11.1. Returning Defective Merchandise.....	49

1.1. Table of Figures

Fig. 1: Bottom view.....	18
Fig. 2: Right view.....	18
Fig. 3: Frontal view.....	18
Fig. 4: Left view.....	18
Fig. 5: Top view.....	18
Fig. 6: Rear view.....	18
Fig. 7: Front view of the Medi Client IIA (shown as Medi Client IIA 104).....	19
Fig. 8: Hampshire TSHARC Control Panel.....	21
Fig. 9: Select calibration type.....	22
Fig. 10: Configure calibration.....	22
Fig. 11: Calibration.....	22
Fig. 12: Bottom view.....	23
Fig. 13: Detail of the bottom side with interfaces.....	23

Fig. 14: DC Power connector on the bottom (rear) side of the Medi Client IIA system	23
Fig. 15: Color code for current system power state	24
Fig. 16: Example of eError codes.....	24
Fig. 17: Errors priority	24
Fig. 18: Color of the storage drive activity LED, depending on the system configuration	25
Fig. 19: ESD protection cover for the male serial port.....	25
Fig. 20: Color used in the Table 9, Table 10 and Table 11:	28
Fig. 21: Top view	29
Fig. 22: Right side of the Medi Client IIA system	29
Fig. 23: Left side of the Medi Client IIA system	29
Fig. 24: Rear side of the Medi Client IIA system.....	30
Fig. 25: Allowed operating positions of the Medi Client IIA with VESA® 75/100 compliant mounting system (between 0° and 85°).....	31
Fig. 26: Connecting to AC power source via the AC/DC adapter	32
Fig. 27: External AC/DC adapter for with AC power cord for Class II equipment (complying to the EU / US requirements)	32
Fig. 28: Connecting to DC power source	33
Fig. 29: Phoenix plug terminal (option) with “plus” and “minus” marking	34
Fig. 30: Frontal view of the Medi Client IIA 104 system.....	40
Fig. 31: Rear and left side view of the Medi Client IIA 104 system	41
Fig. 32: Detail for VESA® mounting.....	41
Fig. 33: Frontal view of the Medi Client IIA 150 system.....	42
Fig. 34: Rear and left side view of the Medi Client IIA 150 system	42

2. Introduction

Kontron Europe GmbH would like to point out that the information contained in this manual may be subject to technical alteration, particularly as a result of the constant upgrading of Kontron Europe products. The attached documentation does not entail any guarantee on the part of Kontron Europe with respect to technical processes described in the manual or any product characteristics set out in the manual. Kontron Europe does not accept any liability for any printing errors or other inaccuracies in the manual unless it can be proven that Kontron Europe is aware of such errors or inaccuracies or that Kontron Europe is unaware of these as a result of gross negligence and Kontron Europe has failed to eliminate these errors or inaccuracies for this reason. Kontron Europe expressly informs the user that this manual only contains a general description of technical processes and instructions which may not be applicable in every individual case. In cases of doubt, please contact Kontron Europe.



This manual is protected by copyright. All rights are reserved by Kontron Europe. Copies of all or part of this manual or translations into a different language may only be made with the prior written consent of Kontron Europe. Kontron Europe points out that the information contained in this manual is constantly being updated in line with the technical alterations and improvements made by Kontron Europe to the products and thus this manual only reflects the technical status of the products by Kontron Europe at the time of printing.

© 2014 by Kontron Europe GmbH

Printing and duplication, even of sections, is only permissible with the express approval of

Kontron Europe GmbH
Site: Eching
Oskar-von-Miller-Str. 1
85386 Eching
Germany

3. Symbols used in the Instructions for Use

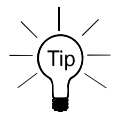







Symbol	Meaning
	This symbol indicates the danger of injury to the user or the risk of damage to the product if the corresponding warning notices are not observed.
	This symbol indicates that the product or parts thereof may be damaged if the corresponding warning notices are not observed.
	This symbol indicates general information about the product and the instructions for use.
	This symbol precedes helpful hints and tips for daily use.

® Microsoft, MS-DOS, Windows 98, Windows 2000, Windows CE.net, Windows XP are registered trademarks of the Microsoft Corporation in the United States and other countries.

® IBM, PC-AT and PS/2 are registered trademarks of the International Business Machines Corporation.

Other product names mentioned in this manual may also be registered trademarks and are used solely for identification purposes.

3.1. Symbols used on the Device

	Power input
	Power button
	RESET button
	USB port
	Read accompanying documentation
	Consult accompanying safety instruction included in the "Instruction for Use"
	Date of manufacture
	Manufacturer
	Non-disposable part

4. Important Instructions

This chapter contains instructions which must be observed when using your Medi Client IIA system. The manufacturer's instructions provide useful information on your device.

4.1. Note on the Warranty

Due to their limited service life, parts which by their nature are subject to a particularly high degree of wear (wearing parts) are excluded from the warranty beyond that provided by law. This applies to batteries, to the display backlighting, for example.

4.2. Exclusion of Accident Liability Obligation

Kontron Europe shall be exempted from the statutory accident liability obligation if the user fails to observe the safety instructions.

4.3. Liability Limitation / Exemption from the Warranty Obligation

In the event of damage to the device caused by failure to observe the hints in the "Instructions for Use" and on the device (especially the "General Safety Instructions for IT Equipment"), Kontron Europe shall not be required to honor the warranty even during the warranty period and shall be exempted from the statutory accident liability obligation.



5. General Safety Instructions

Please read this section carefully and observe the instructions for your own safety and correct use of the device. The chapter also contains information on approval and interference suppression of your device. Observe the warnings and instructions on the device and in the "Instructions for Use". The Medi Client IIA system has been built and tested by Kontron Europe in accordance to IEC/EN/UL/CSA 60950-1 and EN 60601-1 and left the company in a perfectly safe condition.

In order to maintain this condition and ensure safe operation, the user must observe the instructions and warnings contained in the "Instructions for Use".

- The device must be used in accordance with the instructions for use.
- The electrical installations in the room must correspond to the requirements of the local (country-specific) regulations.
- Take care that there are no cables, particularly power cables, in areas where persons can trip over them.
- Do not use a power cable in sockets shared by a number of other power consumers. Do not use an extension cable.
- Only use the power cord supplied. Don't use injured or damaged power cords.
- Do not place the device in direct sunlight, near heat sources or in a damp place. Make sure the device has adequate ventilation.
- Only devices and components which fulfill the requirements of an SELV circuit (safety extra low voltage) in accordance with EN60950-1 or EN60601-1 may be connected to the interfaces of the system.
- All plugs on the connection cables must be screwed or locked to the housing.
- The Medi Client IIA system is designed to be used in vertical position with the interfaces downwards. The system may be operated in the positions permitted by the VESA® 75/100 compliant mounting system used but with following restriction: The allowed operating position of the Medi Client IIA with VESA® 75/100 compliant mounting system must be kept between 0° and 85° as shown in Fig. 25.
- Don't stack this device with other electronic devices. Interacting EMC influence may be happen.
- The device generates heat during operation. Make sure it is adequately ventilated. Do not cover the air intake and exhaust openings of the device.
- Repairs may only be carried out by qualified specialist personnel authorized by Kontron Europe.
- Maintenance or repair on the open device may only be carried out by qualified personnel authorized by Kontron Europe which is aware of with the associated dangers.
- Only original accessories approved by Kontron Europe and listed in the "Instructions for Use" may be used; refer also to the accessories included in the chapter 5.4.1 "Compliant Accessories". Failure to do so may result in higher emission levels or to a reduction in immunity to EMC phenomena.
- Don't drop the Medi Client IIA system! If some plastic parts of the enclosure are broken, do not use the Medi Client IIA anymore and disconnect it from the power-source.
- Do not remove the ESD protection cover Fig. 19 mounted to the serial interface of the Medi Client IIA if no serial device is connected to this port (refer to the section 7.2.5.3, Serial Interface Connector).
- The DC input must fulfill SELV requirements of EN60601-1 standard.
- The DC power source should be able to be switched off and on via an isolating switch.
- The unit is only completely disconnected from the DC main power source, when the DC power cord is disconnected either from the power source or the unit. Therefore, the DC power cord and its connectors must always remain easily accessible.

- The main power cable of the optional external AC/DC adapter serves as disconnecting device. For this reason the outlet of the AC power source must be located near to the device and be easily accessible.
- If a risk of injury or, by operation error, a potential hazard occurs for the patient or/and the operator during operation, please fill out the "Incident Report Form" that you can find on the last page on the „Instructions for Use“, and send it to Kontron.
- It must be assumed that safe operation is no longer possible,
 - if the device has visible damage or
 - if the device no longer functions.In these cases the device must be shut down and secured against unintentional operation.

5.1. Instructions for the CMOS (Lithium) Battery

The implemented SBC (Single Board Computer) is equipped with a Lithium battery. The Lithium battery should be replaced by the manufacturer only. Please observe the chapter 8.1 "Maintenance Intervals for the Lithium Battery".



Caution

Danger of explosion when replacing with wrong type of battery. The Lithium battery type must be UL listed.



Do not dispose of lithium batteries in general trash collection. Dispose of the battery according to the local regulations dealing with the disposal of these special materials, (e.g. to the collecting points for dispose of batteries).

5.2. Electrostatic Discharge (ESD)



A sudden discharge of electrostatic electricity can destroy static-sensitive devices or micro-circuitry. Proper packaging and grounding techniques are necessary prerequisites for avoiding damage.

Always take the following precautions:

1. Do not remove the ESD protection cover Fig. 19 mounted to the serial interface of the Medi Client IIA if no serial device is connected to this port (refer to the section 7.2.5.3, Serial Interface Connector).
2. Transport printed circuit boards in static-safe containers such as boxes or bags.
3. Keep electrostatic sensitive parts in their containers until they arrive at a static-free station.
4. Always be properly grounded when touching a sensitive PCB, component, or assembly.
5. Store electrostatic-sensitive PCB's in protective packaging or on conductive foam.

5.2.1. Grounding Methods

Guard against electrostatic damage of the device by taking the following preventative steps:

1. Cover workstations with approved anti-static material. Provide a wrist strap connected to a work surface and properly grounded tools and equipment.
2. Use anti-static mats, heel straps, or air ionizers for added protection.
3. Handle electrostatic-sensitive components, PCB's, and assemblies by the case or the edge of the board.
4. Avoid contact with pins, leads, or circuitry.
5. Turn off power and input signals before inserting and removing connectors or test equipment.
6. Keep the work area free of non-conductive materials such as ordinary plastic assembly aids and Styrofoam.
7. Use field service tools, such as cutters, screwdrivers, and vacuum cleaners that are conductive.
8. Always lay drives and PCB's with the component-side down on the foam.

5.3. Electromagnetic Compatibility (EN 60650-1)

5.3.1. FCC Statement (USA)

This equipment has been tested and found to comply with the limits for a Class B digital device, pursuant to Part 15 of the FCC Rules. These limits are designed to provide reasonable protection against harmful interference in a residential installation. This equipment generates, uses and can radiate radio frequency energy and, if not installed and used in accordance with the instructions, may cause harmful interference to radio communications. However, there is no guarantee that interference will not occur in a particular installation.

If this equipment does cause harmful interference to radio or television reception, which can be determined by turning the equipment off and on, the user is encouraged to try to correct the interference by one or more of the following measures:

- Reorient or relocate the receiving antenna.
- Increase the separation between the equipment and receiver.
- Connect the equipment into an outlet on a circuit different from that to which the receiver is connected.
- Consult the dealer or an experienced radio/TV technician for help.

5.3.2. EMC-Compliance for Canada

(English): This Class B digital apparatus complies with the Canadian ICES-003.

(French) : Cet appareil numérique de la class B est conforme à la norme NMB-003 du Canada.

5.3.3. Electromagnetic Compatibility for EU

This product has been designed for low level of radiated emission for residential, commercial and light-industrial environments and high immunity level for industrial environmental. This product complies with the European Council Directive on the approximation of the laws of the member states relating to electromagnetic compatibility (2004/108/EC).

If the user modifies and/or adds to the equipment (e.g. installation of add-on cards) the prerequisites for the CE conformity declaration (safety requirements) may no longer apply.

5.4. Electromagnetic Compatibility (EN60601-1-2)

The separation distances are written with regard to the Medi Client IIA system. The numbers provided will not guarantee faultless operation but should provide reasonable assurance of such. This information may not be applicable to other medical electrical equipment, and older equipment may be particularly susceptible to interference.

General Information

Medical electrical equipment needs special precautions regarding electromagnetic compatibility (EMC) and needs to be installed and put into service according to the EMC information provided in this "Instruction for Use".

Portable and mobile RF communications equipment can affect medical electrical equipment.

Cables and accessories not specified within the "Instructions for Use" are not authorized. Using other cables and/or accessories may adversely impact safety, performance and electromagnetic compatibility (increased emission and decreased immunity).

Caution:

The Medi Client IIA should not be used adjacent to or stacked with other equipment; if adjacent or stacked use is inevitable, the equipment should be observed to verify normal operation in the configuration in which it will be used.

Note

The Medi Client IIA is intended for use in the electromagnetic environments specified below. The user of this equipment should assure that it is used in such an environment.

Electromagnetic Emissions		
Medi Client IIA is intended for use in the electromagnetic environment specified below. The operator should assure that it is used in such an environment.		
Emissions	Compliance according to...	Electromagnetic environment
RF emissions (CISPR 11)	Group1	The Medi Client IIA uses RF energy only for its internal function. Therefore, its RF emissions are very low and are not likely to cause any interference in nearby electronic equipment.
CISPR Emissions Classification	Class B	The Medi Client IIA is suitable for use in establishments including domestic establishments and those directly connected to the public low voltage power supply network that supplies buildings used for domestic purposes.
Harmonic emissions (IEC 61000-3-2)	Class D	
Voltage fluctuations / flicker (IEC 61000-3-3)	Complies	

Table 1: Information regarding electromagnetic emissions (IEC 60101-1-2, table 201)

Electromagnetic Immunity			
The Medi Client IIA is intended for use in the electromagnetic environment specified below. The operator should assure that it is used in such an environment.			
Immunity against...	IEC 60601-1-2 test level	Compliance level (Medi Client IIA)	Electromagnetic environment
electrostatic discharge, ESD (IEC 61000-4-2)	contact discharge: ± 6 kV air discharge: ± 8 kV	$\pm 2, 4, 8$ kV, except for the interfaces marked with the ESD symbol	Floors should be wood, concrete or ceramic tile. If floors are covered with synthetic material, the relative humidity should be at least 30 %.
electrical fast transients / bursts (IEC 61000-4-4)	power supply lines: ± 2 kV longer input / output lines: ± 1 kV	± 2 kV, ± 1 kV	Mains power quality should be that of a typical commercial or hospital environment.
surges on AC mains lines (IEC 61000-4-5)	Common mode: ± 2 kV differential mode: ± 1 kV	± 2 kV, ± 1 kV	Mains power quality should be that of a typical commercial or hospital environment.
power frequency magnetic field 50/60 Hz (IEC 61000-4-8)	3 A/m	30 A/m	If high levels of power frequency magnetic fields occur, the system maybe influenced, so therefore avoid system operating nearby AC-mains cable runway or cable bundle.
voltage dips and short interruptions on AC mains input lines (IEC 61000-4-11)	>95% Interruption for 10 ms 30% Dips for 500ms 60% Dips for 100ms >95% Interruption for 5000ms	according the test levels from IEC60601-1-2	Mains power quality should be that of a typical commercial and/or hospital environment. If the user of the Medi Client IIA requires continued operation during power mains interruptions, it is recommended that the Medi Client IIA is powered from an uninterruptable power supply.

Table 2: Electromagnetic Immunity

Electromagnetic Immunity			
The Medi Client IIA is intended for use in the electromagnetic environment specified below. The customer or the user of the Medi Client IIA should assure that it is used in such an environment.			
Immunity test	IEC 60601 test level	Compliance level (Medi Client IIA)	Electromagnetic environment - guidance
Conducted RF IEC 61000-4-6	3 Vrms 150 kHz to 80 MHz	[U ₁] V U ₁ =10V	Portable and mobile RF communications equipment should be used no closer to any part of the Medi Client IIA, including cables, than the recommended separation distance calculated from the equation applicable to the frequency of the transmitter. Recommended separation distance $d[m] = \left[\frac{3,5}{U_1} \right] \sqrt{P} \approx 0,4\sqrt{P}$
Radiated RF IEC 61000-4-3	3 V/m 80 MHz to 2,5 GHz	[E ₁] V/m E ₁ =10V/m	80 MHz to 800 MHz: $d[m] = \left[\frac{3,5}{E_1} \right] \sqrt{P} \approx 0,4\sqrt{P}$ 800 MHz to 2,5 GHz: $d[m] = \left[\frac{7}{E_1} \right] \sqrt{P} = 0,7\sqrt{P}$ where P is the maximum output power rating of the transmitter in watts [W] according to the transmitter manufacturer and d is the recommended separation distance in metres [m]. Field strengths from fixed RF transmitters, as determined by an electromagnetic site survey, (a.) should be less than the compliance level in each frequency range. (b.) Interference may occur in the vicinity of equipment marked with the following symbol: 
<p>a. Field strengths from fixed transmitters, such as base stations for radio (cellular/cordless) telephones and land mobile radios, amateur radio, AM and FM radio broadcast and TV broadcast cannot be predicted theoretically with accuracy. To assess the electromagnetic environment due to fixed RF transmitters, an electromagnetic site survey should be considered. If the measured field strength in the location in which the Medi Client IIA is used exceeds the applicable RF compliance level above, the Medi Client IIA should be observed to verify normal operation. If abnormal performance is observed, additional measures may be necessary, such as re-orienting or relocating the Medi Client IIA.</p> <p>b. Over the frequency range 150 kHz to 80 MHz, field strengths should be less than 10 V/m.</p>			

Table 3: Guidance and manufacturer's declaration - Electromagnetic Immunity

Recommended separation distances between portable and mobile RF communications equipment and the Medi Client IIA

The Medi Client IIA is intended for use in an electromagnetic environment in which radiated RF disturbances are controlled. The customer or the user of the Medi Client IIA can help prevent electromagnetic interference by maintaining a minimum distance between portable and mobile RF communications equipment (transmitters) and the Medi Client IIA as recommended below, according to the maximum output power of the communications equipment.

Rated maximum output power of transmitter [W]	Separation distance according to frequency of transmitter [m]		
	150 kHz to 80 MHz $d = 0,4\sqrt{P}$	80 MHz to 800 MHz $d = 0,4\sqrt{P}$	800 MHz to 2,5 GHz $d = 0,7\sqrt{P}$
0,01	0,04	0,04	0,07
0,1	0,13	0,13	0,22
1	0,40	0,40	0,70
10	1,26	1,26	2,21
100	4,00	4,00	7,00

For transmitters rated at a maximum output power not listed above, the recommended separation distance **d** in metres [m] can be estimated using the equation applicable to the frequency of the transmitter, where **P** is the maximum output power rating of the transmitter in watts [W] according to the transmitter manufacturer.

NOTE 1 At 80 MHz and 800 MHz, the separation distance for the higher frequency range applies.

NOTE 2 These guidelines may not apply in all situations. Electromagnetic propagation is affected by absorption and reflection from structures, objects and people.

Table 4: Recommended separation distances between portable and mobile RF communications equipment and the Medi Client IIA



Attention:

Use of mobile phones or other HF power transmitting devices nearby the Medi Client IIA maybe influence the function and correct visualization of signals. Therefore please switch off any HF energy emitting devices or keep a distance of minimum 3 m (10 feet) to the Medi Client IIA system. Please observe the value included in the "Table 4".

Caution:

This device works without deviation and the safe operation is ensured only, if the safety, the EMC and the ESD precautions contained in the "Instructions for Use" are observed by the user. Also the labels, stickers and markings on device itself shall be taken into consideration. Please observe the warnings and follow the instructions contained in the "Instructions for Use" or on the labels of the device.

Don't stack this device with other electronic devices. Interacting EMC influence may be happen.

	<p>CAUTION</p> <p>The device is not Defibrillation proved! Be careful, system maybe destroyed by disregarding of this hint.</p>
	<p>CAUTION</p> <p>Possible fire hazard, explosion or ignitions will be happen, when used this device in oxygen enriched atmosphere or mixtures of oxygen and flammable vapors, such as alcohol, ether, ethylene and cyclopropane.</p> <p>The device is not AP or APG classified!</p>

Safe Networking with Medi Client IIA



For a safe networking with electrical equipment, the user is responsible to ensure that the resulting system meets the requirements set forth by the following standards for medical equipment:

EN 60601-1 (IEC 60601-1)	Part 1: General requirements for safety
EN 60601-1-1 (IEC 60601-1-1)	Part 1-1: General requirements for safety; Safety requirements for medical electrical systems
EN 60601-1-2 (IEC 60601-1-2)	Part 1-2: General requirements for safety Electromagnetic compatibility; Requirements and tests
EN 60601-1-4 (IEC 60601-1-4)	Part 1-4: General requirements for safety Programmable electrical medical systems



5.4.1. Compliant Accessories

- Shielded serial cable, length up to 3 m (118.11")
- 10/100/1000 CAT6 Ethernet cable, length up to 10 m (393.7")
- USB Mouse, Microsoft Wheel Mouse Optical 1.1A USB
- USB Keyboard Cherry, Model RS6500 USB
- AC/DC- Adapter, Kontron Part Number (PN): 1036-2985
- For VESA® 75/100 mounting: M4x8 zinc-coated Phillips screw (PN: 0-0068-1058) for or M4x8 V2A stainless steel, Allen screw, flat-head (PN: 0-0068-2575)

6. Scope of Delivery

	Medi Client IIA 104 or Medi Client IIA 150
	Stylus (Touch Pen)
	Phoenix Power Plug Terminal
	This "Medi Client IIA Instructions for Use"

6.1. Optional Parts

	AC/DC Adapter for Class II devices [Part Number (PN): 1036-2985]
	Power Cord (complying to the EU requirements)
	Power Cord (complying to the US requirements)
Screws for VESA® 75/100 mounting	M4x8 zinc-coated Phillips screws [Part Number (PN): 0-0068-1058] or M4x8 V2A stainless steel Allen screws flat-head [Part Number (PN): 0-0068-2575]

6.2. Labels and Product Identification

System Type	Part Number	Product Identification
Medi Client IIA	2-A0HI-xxxx	Medi Client IIA 104 (Medi Client IIA with a 10.4" display)
	2-A0HJ-xxxx	Medi Client IIA 150 (Medi Client IIA with a 15" display)

The type label with the corresponding product part number is at the rear side of the system. These part numbers correspond to the part numbers for Certification testing by UL, and other certifying agencies.

On the type label of your system is an alphanumeric characters combination (MN) according to the ordered system configuration (the /"xxxx"/ group of the MN defines the system configuration).

The inspection status label and the type label (product designation, serial number) are located on the rear side of the device.

7. Product Description

Before you begin using your Medi Client IIA system, you should take a few minutes to learn about the various ports, connectors and indicators that are part of your Medi Client IIA system, as well as the components that make up the system.

The Medi Client IIA is a Human-Machine-Interface (HMI) system designed for demanding medical applications as interface device for the operator in order to visualize the operations from medical applications and saving data and images. The Medi Client IIA is not designed for diagnostic use.

The Medi Client IIA system is equipped with a 10.4" or a 15" display. In front of the display there is installed a touch screen, that also protects the display surface from dirt and scratches.

It is designed to be mounted by a VESA® 75/100 mounting system.

The Medi Client IIA system accommodates a Single Board Computer (SBC) with an on board CompactFlash™-slot (IDE).

The system can be optionally equipped with a CF card, type I and/or an internal 2.5" HDD (SATA).

The operating elements of the Medi Client IIA system consist of:

- Power button: one power button is located on the displays front panel of the system and the second power button on the rear (bottom) side.
- LED indicators: one power LED is located on the displays front panel of the system and the second power LED on the rear (bottom) side
- Reset button

The interfaces 1x serial (RS232), 2x LAN (10/100/1000 Mbps), 2x USB (2.0) and 1x VGA are located on rear (bottom) side. For ESD protection an ESD protection cover is mounted to the serial interface of the Medi Client IIA.

An additional USB port is available on the left side (rear) of the unit. This USB connector is covered by an elastic captive rubber coat.

The Medi Client IIA system is designed to be connected to a +24 (12-24) VDC power source using the DC power terminal.

In order to connect the system to an AC power supply the optional external AC/DC adapter can be ordered.

The Medi Client IIA and the optional AC/DC adapter are verified and certified as protection class II devices [without PE (protection Earth) connection].

The Medi Client IIA system is designed to comply with the IP21 protection class.

The Medi Client IIA system is a fanless system. The air openings, located on the rear side of the device provide air circulation for the system interior cooling, in order to prevent overheating. The integrated SBC provides a self protection against overheating if the SBC's temperature sensors will measure a temperature level out of the limits. Please observe the chapter 8.2 "System Self Protection against Ambient Overheating".



When powering on the Medi Client IIA system, make sure that the air intake and exhaust openings are not obstructed.

The Medi Client IIA system ensures the IP 21 protection class. At the display front side the protection class IP65 is ensured.



Intended Use

The "essential performance" of the Medi Client IIA system is to control medical equipment with medical applied parts (e.g. as user terminal for x-ray or endoscopic devices).



It is not allowed to use the Medi Client IIA system as a diagnostic system or a patient monitoring system!



The Medi Client IIA is delivered without any medical application software.

Only approved and certified medical application software, that comply with the standard IEC60601-1-4 and respectively ISO 14971 shall be used and installed on the Medi Client IIA.



Fig. 1: Bottom view



Fig. 2: Right view



Fig. 3: Frontal view



Fig. 4: Left view



Fig. 5: Top view



Fig. 6: Rear view

7.1. Front Side View

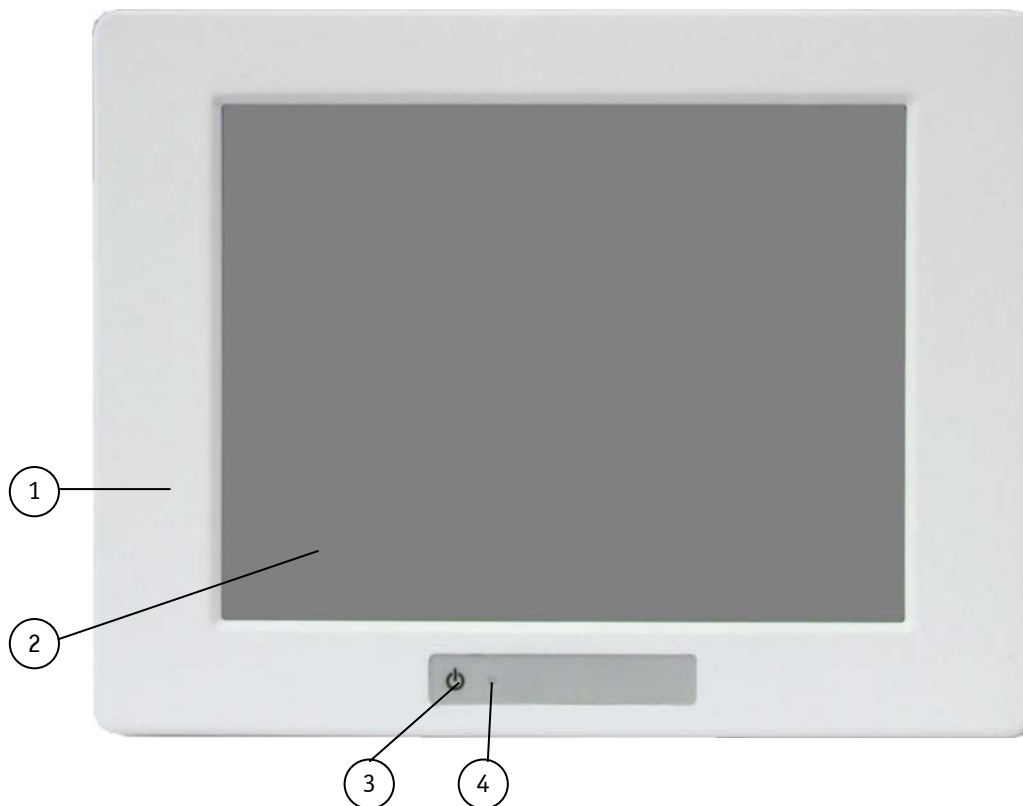

Fig. 7: Front view of the Medi Client IIA (shown as Medi Client IIA 104)

- | | |
|---------------------------------------|----------------|
| 1 Front plate | 3 Power button |
| 2 10.4" TFT display with touch screen | 4 Power LED |

At the front side are located:

- Power button and power LED
- Front plate for the 10.4"/15" display
- 10.4"/15" display with corresponding resistive touch screen

For the outline dimensions of unit are refer to the chapter 9.3 "Mechanical Specifications".

7.1.1. Power Button on the Front Side

The power button (Fig. 7, pos. 3) allows to power ON or OFF the Medi Client IIA system. This power button works in an "OR" function together with the power button located on the interface side. Refer to the section 7.2.2 "Power Button on the Interface Side).

7.1.2. Power LED on the Front Side

The power LED (Fig. 7, pos. 4) indicates the power states of the system.

The system is connected to the power source	Power Button (front/rear)	Power LED (front)	Medi Client IIA System Status
Medi Client IIA	Off	orange	The system is in "standby"
	On	green	The system is running.

Table 5: System Power states



Please observe that this power LED does not indicate error codes if malfunction conditions of the system occur. Only the power LED (Fig. 13, Pos. 10) on the interface side signals a malfunction condition via error codes (Refer to the section 8.2).



Even when the system is turned off via power button (front or rear) there is still a standby-voltage of 5 V on the SBC board. The system is not completely disconnected from the main power source by turning off via the power button.

Hints for DC power connection:

The DC main power supply should be able to be switched off and on via a 2-pole isolating switch. The unit is only completely disconnected from the DC main power supply, when the DC power cord is disconnected either from the DC main or the unit. Therefore, the DC power cord and its connectors must always remain easily accessible.

Hints for AC power connection via the optional external AC/DC adapter:

The main power cable of the external AC/DC adapter serves as disconnecting device. For this reason the outlet of the AC power source must be located close to the device and be easily accessible.

7.1.3. Display (10.4"/15") with Touch Screen

The built-in display is a 10.4" or a 15" size TFT display with corresponding resistive touch screen. The touch screen is USB connected. For technical specification of the built-in display refer to the chapter 9 "Technical Data".

The display is equipped with a resistive touch screen. The touch screen offers the same degree of user comfort as the mouse buttons. A stylus is supplied for touch screen operation. The surface of the display is also mechanically protected through the touch screen. The touch screen registers contacts of a finger or a pen and allows moving the mouse pointer. Use a stylus (included) for best results.

You get the corresponding touch screen driver for your operating system, installed on your Medi Client IIA system.



Do not use a hard or a pointed object (like screw drivers) to operate the touch screen, since it can damage the touch screen surface.

For cleaning and disinfection of the Medi Client IIA please refer to chapter 8.3 and 8.4.

7.1.3.1. Calibrating the Touch Screen

Calibration serves two purposes:

- Sets the active area of the touch screen
- Aligns the active area of the touch screen to the screen's image.



Before you calibrate the touch screen, let the system warm up for 30 minutes.

Calibration aligns the active touch-sensitive area of the touch screen with the image on the display. Calibration also determines the edges of the screen's image and locates the center of the touch screen. If the touch screen is not calibrated properly, the active area of the touch screen may not be aligned with the screen's image or may be unnecessarily small in size. If necessary, in order to access the calibration routine, use an USB mouse.

7.1.3.2. Calibrate the Touch Screen

The touch screen of your Medi Client IIA system is factory calibrated. Run the calibration routine when an alignment problem exists between the mouse pointer and the stylus contact location on the screen. You can adjust the touch screen calibration by:

- Running the touch screen property sheet from the Start-Programs and clicking on "Hampshire TSHARC Control Panel". The following screen will appear:

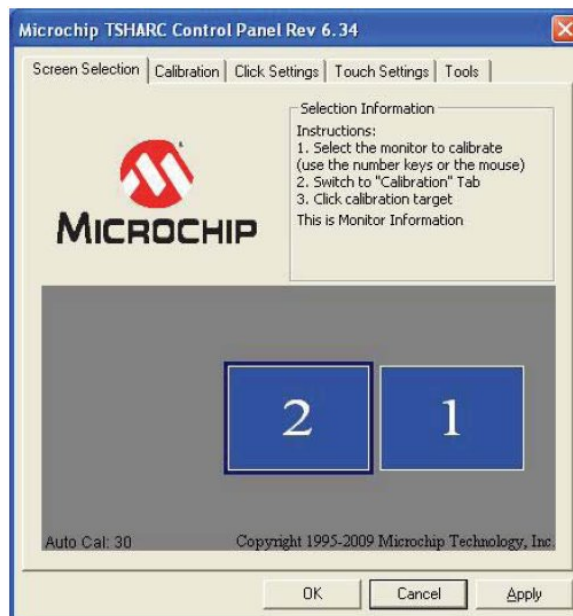

Fig. 8: Hampshire TSHARC Control Panel

Navigate using the available tabs.

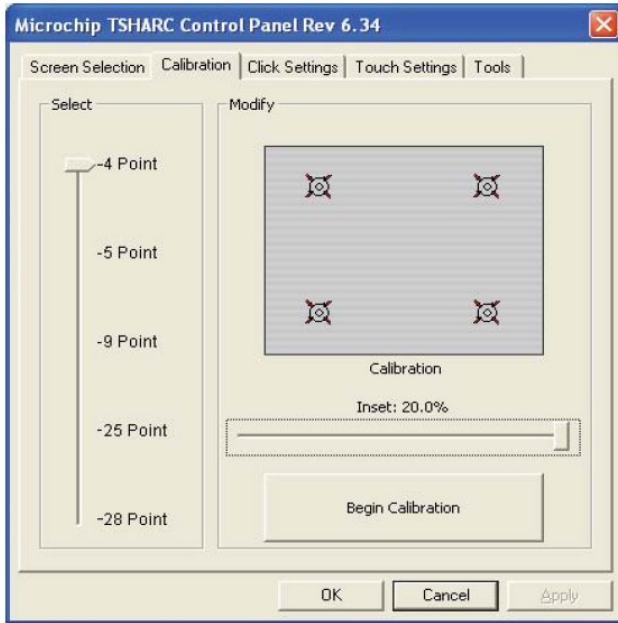

Fig. 9: Select calibration type

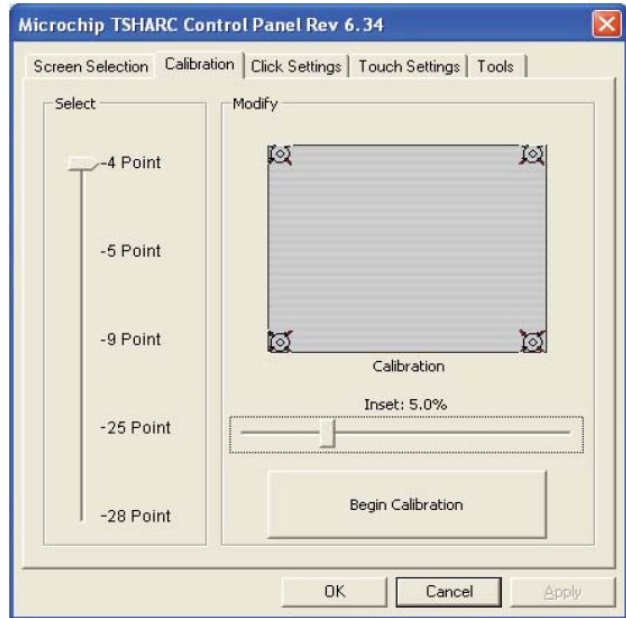

Fig. 10: Configure calibration

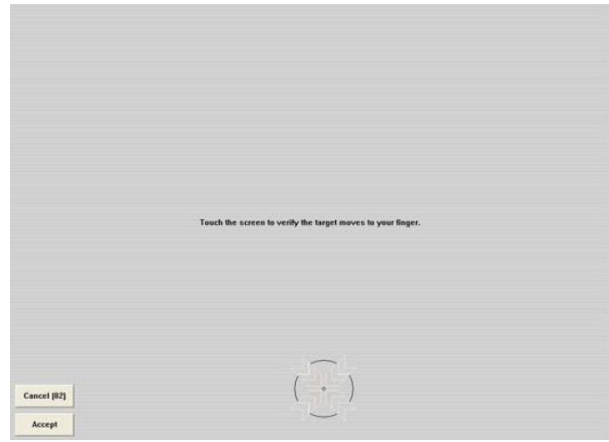
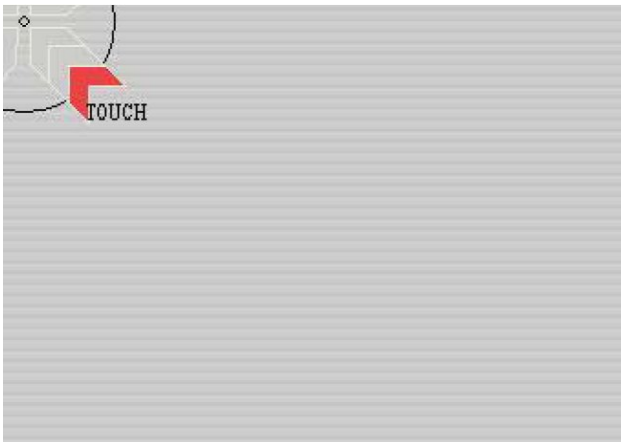

Fig. 11: Calibration

7.2. Bottom View

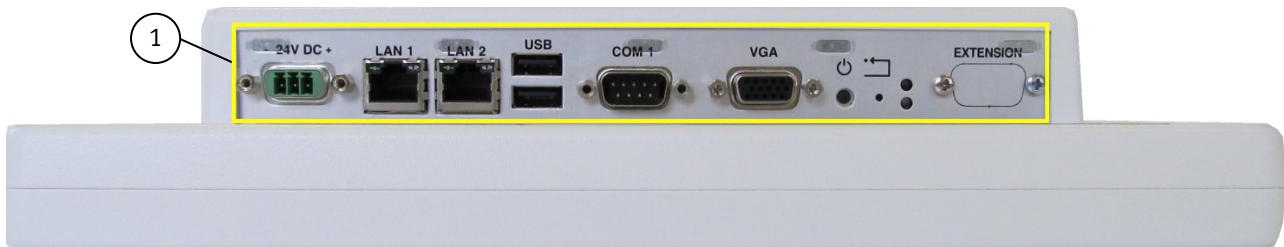

Fig. 12: Bottom view

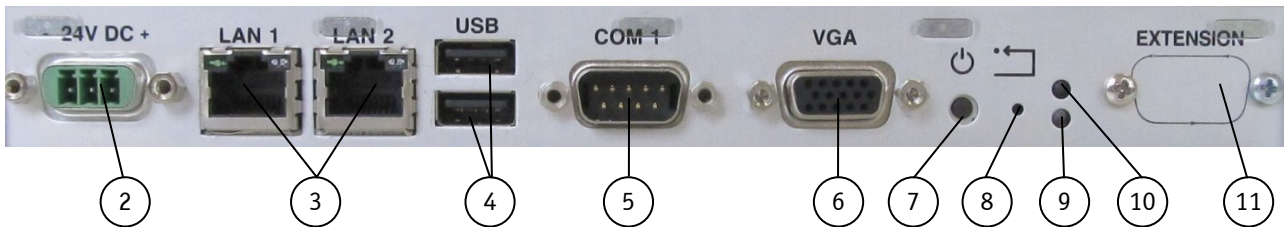

Fig. 13: Detail of the bottom side with interfaces

Legend for Fig. 12 and Fig. 13:

- | | |
|--|--|
| 1 Power, controls and interfaces on the bottom side | 6 VGA interface connector |
| 2 DC power connector (24VDC) | 7 Power button |
| 3 2x Ethernet (10/100/1000 Mbps) interface connector | 8 Reset button |
| 4 2x USB (2.0) connector | 9 HDD LED |
| 5 COM1 serial port connector (RS232) | 10 Power LED |
| | 11 Knock out for additional interfaces |

7.2.1. Power and Reset

7.2.1.1. DC In Power Connector



Fig. 14: DC Power connector on the bottom (rear) side of the Medi Client IIA system

The DC In power connector (refer to Fig. 13, pos. 2 and Fig. 14) provides the power connection of the Medi Client IIA system to the main power source via the DC power cable (optional accessory) or via the AC/DC adapter (optional accessory). For the pin assignment refer to the section 10.1.1 "Power Connector."

7.2.1.2. Reset Button

To restart the system, e.g. after a system hang-up, press the RESET button (Fig. 13, pos. 8). The system restarts automatically without turning the computer off and on again.



During a reset all data in the main memory will be erased.

7.2.2. Power Button on the Interface Side

The power button (Fig. 13, pos. 7) allows to power ON/OFF the system. Please observe the settings in BIOS Setup / Chipset Configuration / South Bridge Configuration / Restore on AC Power Loss with option settings: **Power on** (default)/ Power off).

Please observe the description in the section 8.2 "System Self Protection against Ambient Overheating". The power button is deactivated as long as the protection against overheating function is active.



Even when the system is turned off via the power button there is still a standby-voltage of 5 V on the SBC. The system is not completely disconnected from the main power supply by turning off via the power button.

Hints for DC power connection:

The DC main power supply should be able to be switched off and on via a 2-pole isolating switch. The unit is only completely disconnected from the DC main power supply, when the DC power cord is disconnected either from the DC main or the unit. Therefore, the DC power cord and its connectors must always remain easily accessible.

Hints for AC power connection via the optional external AC/DC adapter:

If the Medi Client IIA system is connected to an AC power source via an AC/DC adapter, the main power cable of the external AC/DC adapter serves as disconnecting device. For this reason the outlet of the AC power source must be located near to the device and be easily accessible.

7.2.3. Power LED on the Interface Side and Error Codes

The power LED (Fig. 13, pos. 10) indicates the current system power state (S0, S3, S4, or S5) as shown in the Fig. 15. The power LED will blink red if an error condition was detected; refer to the Fig. 16 and Fig. 17. The blink code is independent from the systems power states LED color. The color red is reserved for error codes, only.

Power LED: Color code for current power state	
S0	S3 or S4 or S5
green	orange

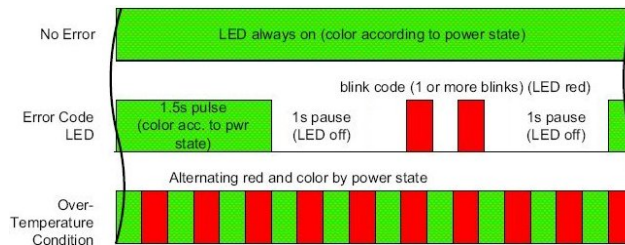

State / Error	Priority (blinks)
OK	-
Voltage Error	1
Temp. Error	2
Battery Error	4

Fig. 15: Color code for current system power state

Fig. 16: Example of eError codes

Fig. 17: Errors priority

An over-temperature condition has the highest of all priorities. Please observe the description in the chapter 8.2 "System Self Protection against Ambient Overheating". The power button is deactivated as long as the temperature is too high. To signalize this emergency state, the LED alternates between red and the current power state color.

Note: Higher priority codes will not interrupt a code which has started until the current blink code is completed.

7.2.4. Storage Drive Activity LED

Refer to (Fig. 13, pos. 9) for the storage drive activity LED location. Depending on the system configuration [a CF card, type I and/or an internal 2.5" HDD (SATA)] and storage drive/s activity this LED may be blinking as shown below:

Power state of the system	Storage drive/s activity on the system	Color of the storage drive activity LED
ON	only CF card (PATA)	green
	only HDD (SATA)	red
	simultaneously: CF card and SATA HDD	orange
	no activity on any storage drive of the system	off

Fig. 18: Color of the storage drive activity LED, depending on the system configuration

7.2.5. Interfaces (Rear, Bottom Side of the System)

7.2.5.1. Ethernet Interface Connectors

These interface connectors (refer to Fig. 13, pos.3) are provided as RJ45 sockets with integrated LEDs and support a 10/100/1000 Mbps data transfer rate.

Ethernet LED States:

Left LED State	Link Activity State	Right LED State	Link Speed
off	Link not active	Off	10 Base-T
green	Link active	green	100 Base-T
green	Link active	orange	1000 base-T

7.2.5.2. USB interface Connectors

The system is equipped at the bottom side (rear) with two USB 2.0 interface connectors (refer to Fig. 13, pos. 4). These connectors provide connections for USB-compatible devices.

7.2.5.3. Serial Interface Connector

This RS232 connection (refer to Fig. 13, pos. 5) is available as 9-pin D-SUB connectors (male) and provides connection (RS232) for serial devices. The system is delivered with an ESD protection cover (Fig. 19) mounted to this serial interface in order to ensure the ESD protection if no serial device is connected to this port.



Fig. 19: ESD protection cover for the male serial port



The ESD protection cover (Fig. 19) should be removed only when a serial device will be connected to the serial port.

7.2.5.4. VGA Interface Connector

An external (analog) monitor can be plugged into this interface (refer to Fig. 13, pos. 6) which is provided as a 15-pin D-SUB socket.

7.2.5.5. Knock out for Additional Interfaces labeled "Extension"

On customer request, the configuration of the Medi Client IIA system can be expanded with an optional interface (Fig. 13, pos. 11) as: RS232 or RS422/485 or LPCtoCAN (SJA1000) adapter. The expansion of the system and the custom settings can be carried out by the manufacturer only. The corresponding pin assignments for your customized system configuration you can find in the chapter 10.



The customer specific configuration for this extension port as RS232 or RS422/485 or LPCtoCAN (SJA1000) adapter can only be carried out by the manufacturer.

When ordering a system with a RS422/485 port or CAN BUS port, you need to specify the requirements (configuration) of this port.

For a custom configuration of the serial port as RS422 or RS485, please observe the "Quick Reference Guide" for "EASY 485/422" on our web site www.kontron.com.

7.2.5.6. Extension as RS422/RS485 Serial Interface Connector

Serial Communication Type	Transmitting<->receiving
RS422 4-Channel Mode	-
RS485 4-Wire Mode (Bus-Master)	-
RS485 2-Wire Mode	RTS
RS485 2-Wire Mode	Timeout

Table 6: Settings for serial communication type

Termination Resistor for RS422 and RS485
Deactivated
Activated

Table 7: Setting in order to activate or deactivate the termination resistor

Timeout	Min. Baudrate
10.2ms	1200
9.6ms	
9.0ms	
8.4ms	
7.8ms	
7.2ms	
6.5ms	
5.9ms	
4.8ms	2400
4.3ms	
3.7ms	
3.1ms	
2.5ms	4800
1.9ms	
1.2ms	9600
0.6ms	19200

Table 8: Settings in order to set the needed Timeout and min. Baudrate

7.2.5.7. Extension as CAN BUS Interface

The factory settings for SJA1000-base address, the SJA-interrupt, and the NVRAM operation mode.

	Factory settings for the CAN BUS interface
--	--

Fig. 20: Color used in the Table 9, Table 10 and Table 11:

SJA Base Address

Address Range
0x340 to 0x35F
0x320 to 0x33F
0x300 to 0x31F
0x220 to 0x23F
0x200 to 0x21F ¹
0x140 to 0x15F
0x120 to 0x13F
0x100 to 0x11F

Table 9: SJA-Base Address Settings

SJA-Interrupt

IRQ
disabled
15
11
10
7
5
4
3

Table 10: SJA-Interrupt Settings

NVRAM-Operation Mode

Mode
disabled
IO-mode
Memory at C0000
Memory at D0000

Table 11: NVRAM-Operation Mode Settings

7.3. Top, Left and Right Side View



Fig. 21: Top view

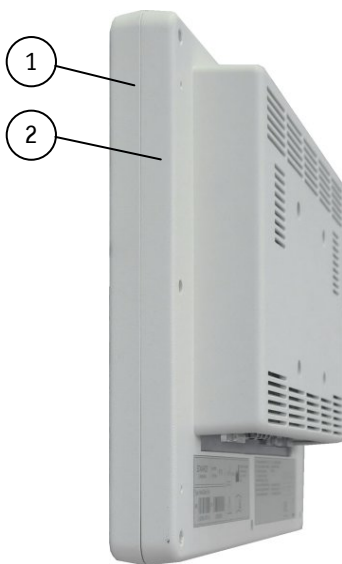

Fig. 22: Right side of the Medi Client IIA system

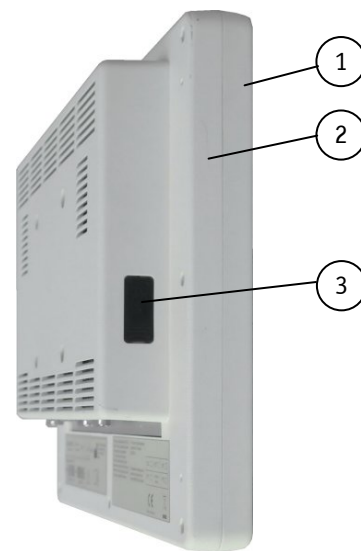

Fig. 23: Left side of the Medi Client IIA system

Legend for Fig. 21, Fig. 22 and Fig. 23:

- | | |
|--|--------------------|
| 1 Front part of the display/system enclosure | 3 Covered USB port |
| 2 Rear part of the display/system enclosure | |

7.3.1. USB Interface Connector on the Left Side of the System

The USB connector (Fig. 23, pos. 3) is covered by an elastic captive rubber coat. The rubber coat prevents the penetration of fluid, if no device is connected.

This connector USB 2.0 allows you to connect different USB-compatible devices to the Medi Client IIA system.



The Medi Client IIA system only complies with IP21 protection class if the left side USB connector is covered by the elastic captive rubber coat.

The front display side the Medi Client IIA system only ensures the IP65 protection class.

7.4. Rear View

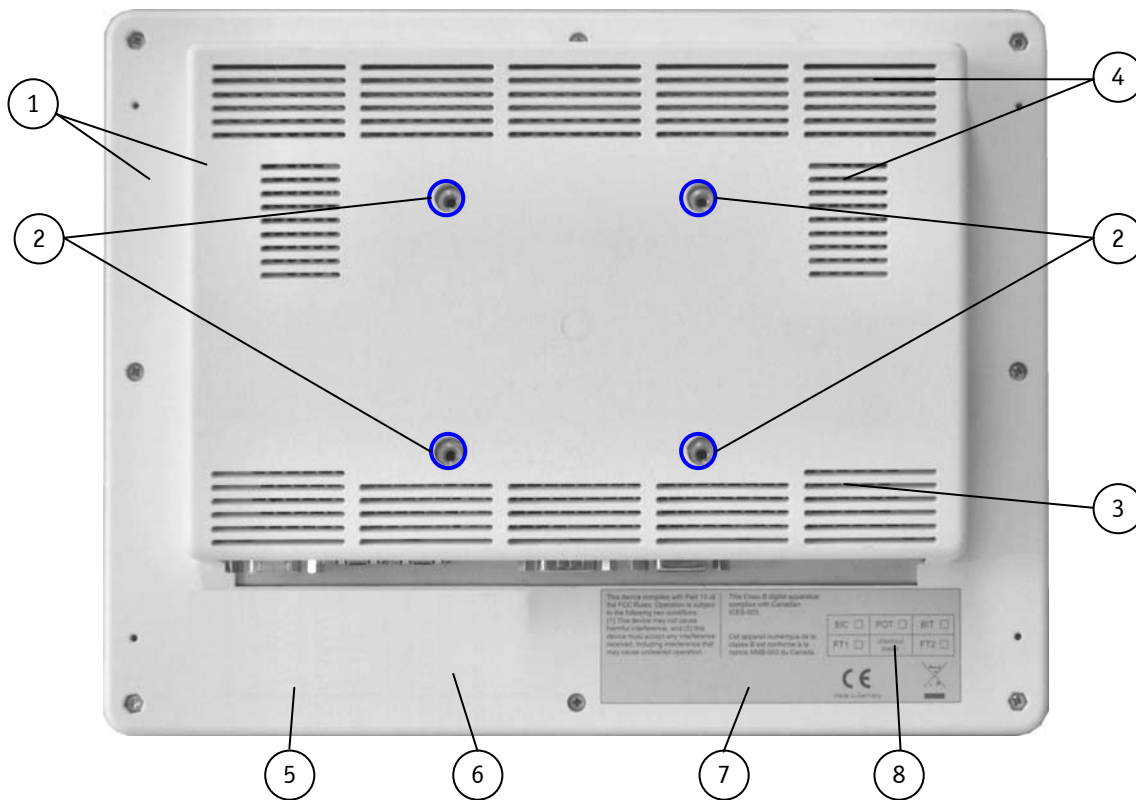

Fig. 24: Rear side of the Medi Client IIA system

- | | | | |
|---|---|---|--|
| 1 | Rear part of the display/system enclosure | 5 | Location for type label of the system |
| 2 | 4x threaded holes (marked blue in the picture) for mounting on VESA® 75 compliant mounting system | 6 | Location for label for medical devices |
| 3 | Air intake openings | 7 | FCC verification label |
| 4 | Air exhaust openings | 8 | Inspection status label |



When powering on the Medi Client IIA system, make sure that the air intake and exhaust openings are not obstructed.



Medi Client IIA 104 is VESA® 75 compliant and the Medi Client IIA 150 is VESA® 75/100 compliant. Use four M4 metric screws to attach the system to a VESA® mounting system. Depending on the VESA® mounting system used, choose the length of the screws so that the screw-in depth of the screws should be between 4mm (0.16") up to 7mm (0.28"). For corresponding screws refer to the screw type included in the chapter 6.1 "Optional Parts".

Using longer screws could damage the internal components of the Medi Client IIA system. For VESA® mounting details, please observe the Fig. 31, Fig. 32 and Fig. 34.

7.5. Internal Storage Device

The system can be optionally equipped with a CF card, type I and/or an internal 2.5" HDD (SATA).

7.6. Mounting to an optional VESA® Mounting System



The Medi Client IIA system can be mounted to an optional VESA® 75/100 compliant mounting system.

- ❑ Medi Client 104 is VESA® 75 compliant (refer to Fig. 31).
- ❑ Medi Client 150 is VESA® 75/100 compliant (refer to Fig. 34).

The Medi Client IIA system is designed to be used in vertical position with the interfaces downwards.

The system may be operated in the positions permitted by the VESA® 75/100 mounting system used but with following restriction:



The allowed operating positions of the Medi Client IIA with VESA® 75/100 compliant mounting system are only between 0° and 85° as shown in Fig. 25.

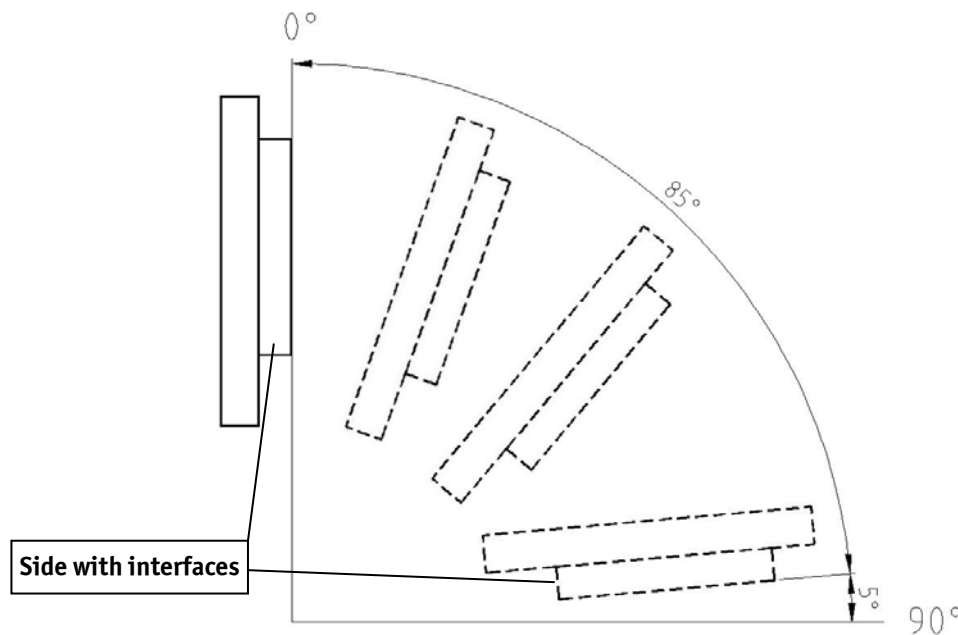

Fig. 25: Allowed operating positions of the Medi Client IIA with VESA® 75/100 compliant mounting system (between 0° and 85°).



Use four M4 metric screws to attach the system to a VESA® 75/100 mounting system. Depending on the VESA® mounting system, choose the length of the screws so that the screw-in depth of the screws should be between 4mm (0.16") up to 7mm (0.28").

Using longer screws could damage the internal components of the Medi Client IIA system.

For VESA® mounting details, please observe the Fig. 31, Fig. 32 and Fig. 34.



When powering on the Medi Client IIA system, make sure that the air intake and exhaust openings are not obstructed.

In order to ensure a proper operation of the system, we recommend keeping the ambient temperature around an operating Medi Client IIA system within the specified intended use temperature range (0°C-40°C).

7.7. Getting started

In order to use a DC power source as main power source, a Phoenix Power Plug Terminal for connecting a DC power cable to the system can be ordered.



- Before using your system, you should first become familiar with the system components and check that everything is connected properly.
- It is recommended that the last cable attached to the system should be the power cable!

7.7.1. Connecting to AC Power Source via the optional AC/DC Adapter

The Medi Client IIA system can be connected to the AC power source via the optional AC/DC adapter (refer to Fig. 26 and Fig. 27).

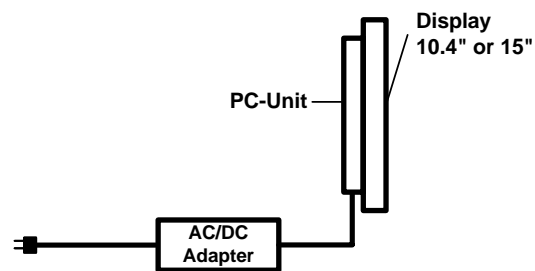

Fig. 26: Connecting to AC power source via the AC/DC adapter



Fig. 27: External AC/DC adapter for with AC power cord for Class II equipment (complying to the EU / US requirements)

AC/DC Adapter for Class II equipment	
AC Input	DC Output
100-240 V	24 VDC
1.5 -0.7A	2.5 A
47-60 Hz	



If the Medi Client IIA is used with an optional AC/DC adapter, the operation of the Medi Client IIA is permitted only with original accessories approved by Kontron Europe:

- "external AC/DC adapter", Part Number: 1036-2985

Follow these steps in order to connect the Medi Client IIA to an AC power source via the optional AC/DC adapter:



Attach the supplied AC power cable (for EU or US) that corresponds to the requirements of the country where the system is used.

The AC/DC adapter must stand freely and may not be covered. Do not place the AC/DC adapter onto a heat-sensitive surface.

There must be at least 100 mm (approximately 4") free space around the Medi Client IIA system and around the AC/DC adapter.

1. Connect the 3-pin DC power connector of the AC/DC adapter (Fig. 27) to the appropriate DC power connector (Fig. 13, pos. 2) of the Medi Client IIA system. The DC power connector of the system is on the rear bottom side. Make sure the connector is securely locked in place.
2. Connect the AC power cord to the AC/DC adapter.
3. Plug the AC connector of the adapter into an AC wall outlet of the AC power source.
4. Turn on the Medi Client IIA system via the power button

7.7.2. Connecting to DC Power Source (Option)

The Medi Client IIA system will be connected to a DC power source using the DC power cable confectioned as described in the chapter 7.7.2.1 "DC Power Cable Connector (Option)".

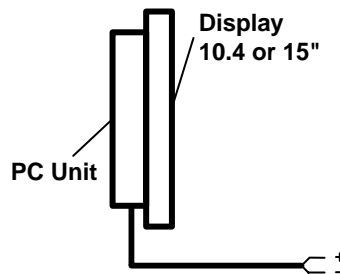

Fig. 28: Connecting to DC power source

1. Connect the 3-pin DC power connector of the DC power cable to the appropriate DC power connector (Fig. 13, pos. 2) of the Medi Client IIA system. The DC power connector of the system is on the rear bottom side. Make sure the connector is securely locked in place.
2. Ensure that the DC power source is switched off via a two pole isolating switch, in order to ensure that no power is flowing from the external power source during the connection procedure.
3. Connect the other end of the DC power cable to the terminals of the 24V DC power source. Ensure that the power connections maintain the proper polarity.
4. Switch on the isolating switch in order to apply voltage to the terminals of the power source (cable wires).
5. Turn on the Medi Client IIA system via the power button.



Hints for DC power connection:

The DC power source should be able to be switched off and on via a two pole isolating switch.

The unit is only completely disconnected from the DC main power source, when the DC power cord is disconnected either from the power source or the unit. Therefore, the DC power cord and its connectors must always remain easily accessible.

The DC power source to be used with the Medi Client IIA system must be galvanically isolated according to IEC60601-1 safety of medical devices!

If you are not sure, use the optional AC/DC adapter listed in this "Instructions for Use".

7.7.2.1. DC Power Cable Connector (Option)

The Medi Client IIA can be ordered with a DC power plug terminal (3-pin Phoenix connector). For the DC connection prepare the connecting wires using the Phoenix plug terminal (optional part).

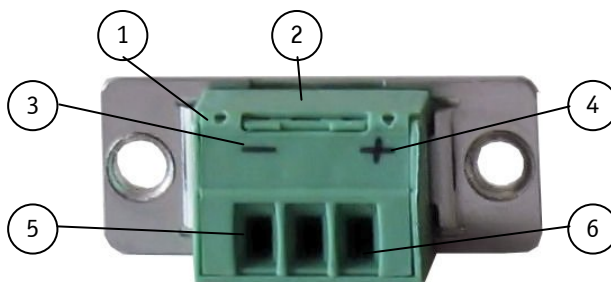

Fig. 29: Phoenix plug terminal (option) with "plus" and "minus" marking

- | | |
|--|---|
| 1 3-pin Phoenix plug terminal | 4 Marking "plus" |
| 2 Cover over the slotted pan head screws | 5 Location for inserting the "minus" wire |
| 3 Marking "minus" | 6 Location for inserting the "plus" wire |

1. Cut two isolated wires to the required length [AWG18 (\varnothing minimum 1 mm²; maximum length: 5 m)].
2. Strip each end 5 –7 mm.
3. Twist the striped wire-ends and tin it with solder.
4. Open the cover to have access to the slotted pan head screws.
5. Loosen the two slotted pan head screws (that correspond to the marked location "+" and "-" of the DC plug terminal) far enough so that you can insert the end of the prepared wires.
6. Insert the wires into the corresponding clamp of the Phoenix plug terminal. Make sure that you have the right polarity of the connection (refer to Fig. 29).
7. Fasten the screws to secure the wires into the clamps of the plug terminal.
8. Close the cover.



The second end of each wire will be prepared as required for the connection to the 24 DC power source.



The DC power source to be used with the Medi Client IIA system must be galvanically isolated according to IEC60601-1 safety of medical devices!

If you are not sure, use the AC/DC adapter provided with the system.

7.8. Operating System and Hardware Component Drivers

Your Medi Client IIA system can be supplied either with or without a pre-installed operating system.

If you have ordered your system with a pre-installed operating system, all drivers are installed in accordance with the system configuration ordered (optional hardware components). Your system is fully operational at the first start-up.

If you have ordered a Medi Client IIA system without a pre-installed operating system, because you want to install it yourself, please pay attention to the following instructions:



You can download the relevant drivers for the installed hardware from our web site at www.kontron.com by selecting the product name (designation).

The corresponding driver (depending on the installed operating system) for the touch screen controller is available on our website by selecting the "Downloads" tab of the Medi Client IIA product page.



Medi Client IIA is delivered without any medical application software.

Only approved and certified medical application software, that comply with the standard IEC60601-1-4 and respectively ISO 14971 shall be used and installed on Medi Client IIA.

7.8.1. Hints for the Installation of the Hampshire® TSHARC™ Touch Screen Controller Driver

7.8.1.1. Preparations of System for Installation Procedure

Before installing the driver please check the following items.

- operating system installed
- USB port driver for operating system installed.
- USB port in BIOS enabled
- Boot or install device are not write protected (EWFmgr)
- download driver from WEB (Ethernet connection is needed)
- optional: device for loading the drivers is installed (USB Stick / USB CD-ROM)

During the installation of the "Hampshire® TSHARC™ Touch Screen Controller Driver" you have to set following:

- "Controller Type" to: 12 or 10 Bit Controller

and

- "Interface Type" to: "USB".



During the installation of the "Hampshire® TSHARC™ Touch Screen Controller Driver" for the USB connected touch screen, do not use the AUTODETECT feature of the Hampshire® TSHARC™ touch screen driver.

Please observe that during installation no error occurs.



For more information about touch screen calibration you can find in the Hampshire® TSHARC™ UniWinDriver™ Users Manuals for Windows® XP and Windows® XP Embedded on the www.hampshirecompany.com website.

8. Maintenance and Prevention

8.1. Maintenance Intervals for the Lithium Battery

The Medi Client IIA medical HMI should not be opened by the user. A minimum maintenance interval of three and a half years is recommended in order to replace the Lithium battery (CMOS).



This device must be inspected and serviced at regular intervals. A record must be kept on this preventive maintenance. We recommend contacting the Service-Department of your establishment. For repairs we recommend obtaining a service contract with the manufacturer Service-Department through your vendor.

8.2. System Self Protection against Ambient Overheating

The Medi Client IIA system is designed to be protected against ambient overheating.

During operation the system will be automatically turned off, if the ambient temperature around the system exceeds (because of external reasons) the ambient temperature of 50°C and the internal temperature reaches the limit of 85°C (measured on the internal temperature sensor).

What happens after such a turn off?

The system should cool down until the internal measured temperature deceeds: 70°C.

The device turns on automatically and performs a system start as soon as the internal temperature decreases to 70 °C.

Please observe that as long as the internal temperature is too high:

- the color of the power LED (Fig. 13, pos. 10) on the bottom/rear side of the system alternates between red and the current power state color to signalize this emergency state (refer to the section 7.2.3 “Power LED on the Interface Side and Error Codes”),



Please observe that the power LED (Fig. 7, pos. 4) on the display side does not indicate error codes if malfunction conditions of the system occur. As long as the internal temperature is too high the color of this LED (on the display side) stays permanent orange.

- the power buttons function are deactivated (refer also to the section 7.1.1 “Power Button on the Front Side” and 7.2.2 “Power Button on the Interface Side”) and
- the settings in BIOS Setup / Chipset Configuration / South Bridge Configuration / Restore on AC Power Loss with option settings: Power on (default)/ Power off) will also be ignored.



Attention!

In order to ensure a proper operation of the system, we recommend keeping the ambient temperature around an operating Medi Client IIA system within the specified intended use temperature range (0°C - 40°C) (refer to the section 9.2. “Environmental Specifications”).

When the system is turned off via the self protection against ambient overheating function, any unsaved data will be lost. [The Windows does not shut down properly! The system is powered off immediately (like forced off via power button) and enter into 5-volt standby mode as long as the internal temperature is too high.]

8.3. Care and Cleaning

Mild detergent and water is recommended for cleaning. Use of strong solvents, which could attack paint or plastic, should be avoided.

The plastic surface of the Medi Client IIA system is subject to burning and scarring from direct heat sources such as cigarettes. The display front is sealed against dust, liquids, etc.



Use no abrasives, abrasion sponges, steel wool, metal threads, or solvent like alcohol, acetone, washing gasoline to clean the chassis or the touch screen surface of the Medi Client IIA.

Do not use hard or pointed objects, such as knife, pen or pencil tips, to operate the touch screen. Sharp objects can permanently damage the functionality of the touch screen.

8.4. Disinfection



Disinfect Medi Client IIA system before operation with a surface disinfectant. Observe application time and concentration (according to the indications of the manufacturer of the disinfectant).

The front side of the system can be spray disinfected. Use a cloth moistened with disinfectant to clean the rear parts of the system.

Do not spray cleaning/disinfecting agent to the rear side of the Medi Client IIA system.

Do not autoclave the Medi Client IIA system.

Do not immerse or rinse the Medi Client IIA system. Never immerse electrical contacts in water or other liquids.

Steps

1. Disconnect the Medi Client IIA from any AC or DC power source before cleaning.
2. Wipe the Medi Client IIA system with a clean cloth that has been moistened in the cleaning/disinfecting solution. The front side of the system can also be spray disinfected.
3. Prepare agent per manufacturer's instructions or hospital protocol.
4. Wipe thoroughly with a clean cloth.

8.4.1. Recommended surface-disinfectants:

Incidin® Extra (EAN No. 40005 16 802002)

Henkel Hygiene GmbH Düsseldorf, Postfach 130406, Germany

Telephone: 00 49 (2 11) 98 93 – 0, Emergency Number: 00 49 (2 11) 797 -3350

Cidex™ (Active Dialdehyd Solution)

Surgikos, Inc.; P.O. Box 130; Arlington, Texas 76010;

Tel.: ++800-433-5009,

Manufacturer Information under:

Johnson & Johnson Medical Inc. – Customer Service Tel.: ++800-423-5850

9. Technical Data

Medi Client IIA (Class II Equipment)		Medi Client IIA 104	Medi Client IIA 150
TFT LCD Display	Screen size & Active area (H x V) [mm]	10.4"; 211.2 x 158.4mm	15" 304.1 x 228.1
	Resolution (H x V) [pixel]	800 x 600 (SVGA)	1024 x 768 (XGA)
	Pixel Pitch (H x V) [mm]	0.264 x 0.264	0.297 x 0.297
	Colour depth	262k	16.2 M
	Backlight	1x CCFL	2x CCFL
	Brightness cd/m ²	230	350
	Control signal	1x 6bit LVDS	1x 6bit LVDS
	Viewing angle (r / l / u / d)	70 / 70 / 55 / 65	70/70/65/60
	Contrast ratio	500:1	700: 1
Touch Screen		4 wire resistive analog	4 wire resistive analog
VESA® 75/100 compliant		VESA® 75	VESA® 75/100
Single Board Computer with Intel® Atom™ CPU			<input checked="" type="checkbox"/>
Lithium Battery 3.0 V for RTC, Type: CR2032, UL recognized			<input checked="" type="checkbox"/>
Controls and Indicators			
Power Button [on the front and bottom (rear) side]			<input checked="" type="checkbox"/>
Power LED [on the front and bottom (rear) side]			<input checked="" type="checkbox"/>
HDD LED on the bottom (rear) side			<input checked="" type="checkbox"/>
Reset Button [on the bottom (rear) side]			<input checked="" type="checkbox"/>
Interfaces [on the bottom (rear) side]			
USB 2.0			2x
LAN1, LAN2 Ethernet (10/100/1000 Mbps)			2x
VGA			1x
Serial Port RS232 (with mounted ESD protection cover)			1x
Interfaces (on the left side)			
USB 2.0			1x
DC IN Power Connector [3-Pin Connector on the bottom (rear) side]			<input checked="" type="checkbox"/>
BIOS			AMI
Operating System		Refer to the Datasheet for Medi Client IIA on our Website www.kontron.com	
Protection Class (system) IP 21 according IEC 60529			<input checked="" type="checkbox"/>
Optional Parts			
Storage Media		CF Card and/or 2.5" SATA HDD (not included)	
DC Power Terminal (3-Pin Phoenix Conn.)			
External AC/DC Adapter (Class II equipment) with corresponding power cable for EU or for UK or for US			
Screws for VESA® 75/100 mounting		M4x8 zinc-coated Phillips screws (PN: 0-0068-1058) or M4x8 V2A stainless steel Allen screws flat-head (PN: 0-0068-2575)	

9.1. Electrical Specifications

9.1.1. Electrical Specifications for Medi Client IIA System

System Type	Product Designation	Input
Medi Client IIA	Medi Client IIA 104/150	12-24 VDC 2.8-1.8 A max.

9.1.2. Electrical Specifications for the Optional AC/DC Adapter

Optional Parts	AC Input	DC Output
AC/DC Adapter	100-240 V 1.5-0.7 A 47-63 Hz	24 VDC 2.5 A

9.2. Environmental Specifications

Thermal Management	passive cooling (for CPU and system)
Operating Temperature / relative Humidity	0 ... +40 °C, 20-85% (non condensing) (32 ... 104 °F, 20-85% (non condensing))
Storage / Transit Temp. / relative Humidity	-20 ... +60 °C, 5-95% (non condensing) (-4 ... 140 °F, 5-95% (non condensing))
Operating Altitude	up to 3,000 m (10,000 ft)
Atmospheric Pressure (operating)	up to 1060 hPa
Storage / Transit Altitude	up to 4,622 m (15.165 ft)
Operating Shock	15 G, 11 ms duration, half-sinus
Storage / Transit Vibration	30 G, 11 ms duration, half-sinus
Operating Vibration	10-500 Hz; 1G
Storage / Transit Vibration	10-500 Hz; 2.0 G
Protection Class	IP21

9.3. Mechanical Specifications

Dimension for	Medi Client IIA 104	Medi Client IIA 150
Height	226 mm (8.898")	286 mm (11.26")
Width	296 mm (11.563")	363 mm (14.29")
Depth (total)	58.5 mm (1.953")	62 mm (2.44")
Weight	2.2 kg (4.85 lbs)	3.3 kg (7.275 lbs)

9.3.1. Outline Dimensions for Medi Client IIA 104

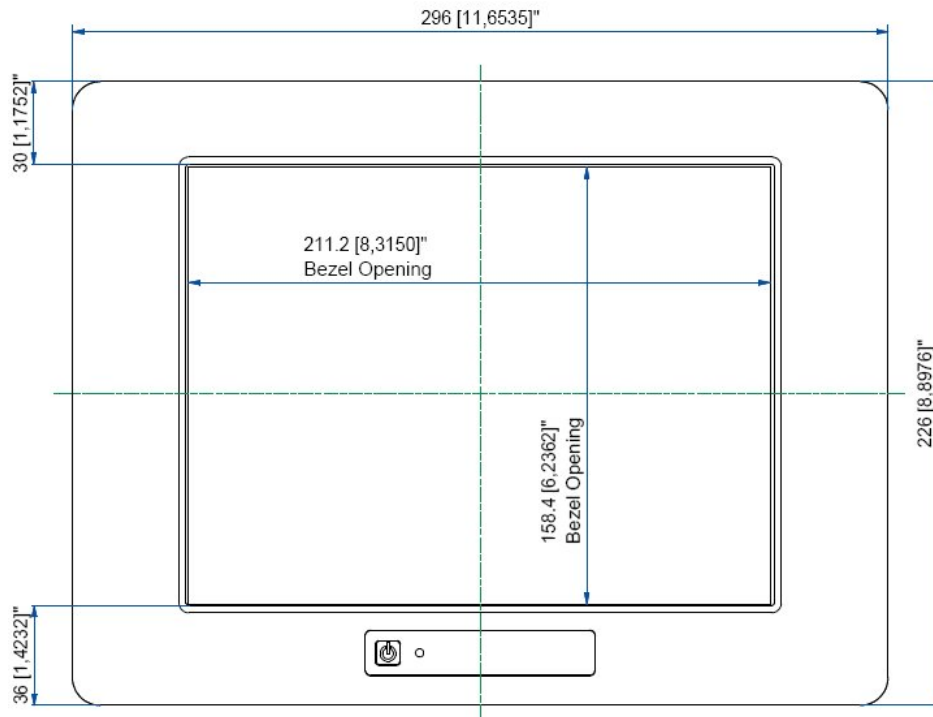

Fig. 30: Frontal view of the Medi Client IIA 104 system

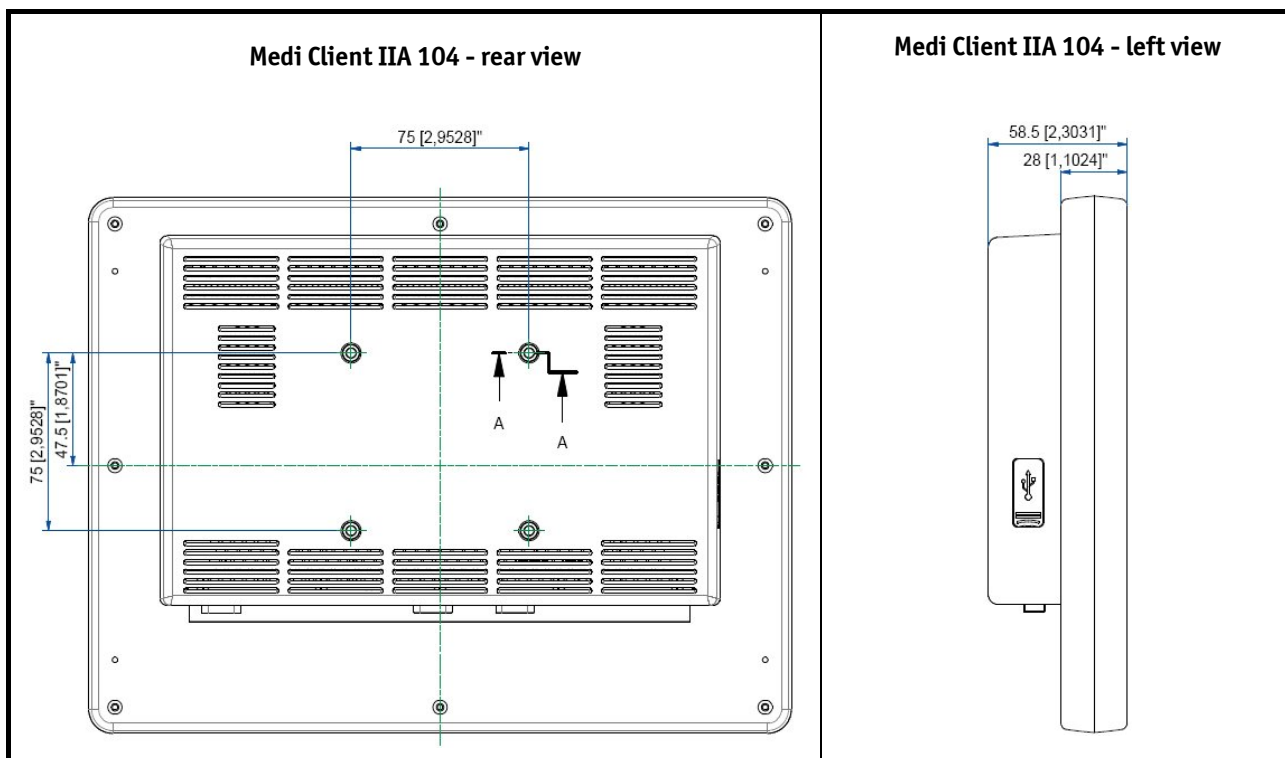

Fig. 31: Rear and left side view of the Medi Client IIA 104 system

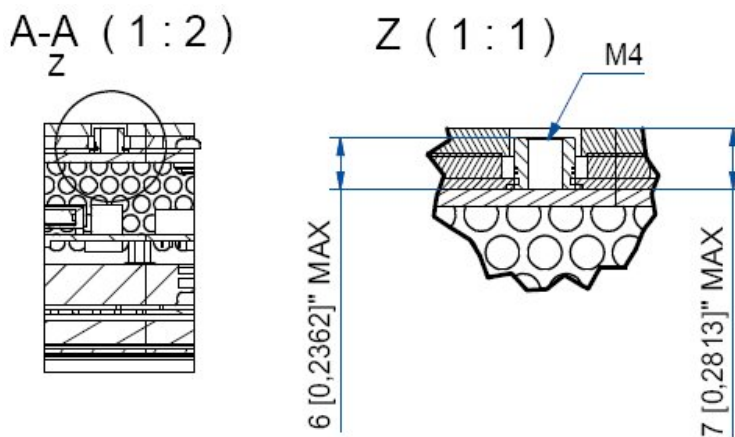

Fig. 32: Detail for VESA® mounting



Medi Client IIA 104 is VESA® 75 compliant.

Use four M4 metric screws to attach the system to a VESA® mounting system. Depending on the VESA® mounting system used, choose the length of the screws so that the screw-in depth of the screws should be between 4mm (0.16") up to 7mm (0.28"). For corresponding screws refer to the screw type included in the chapter 6.1 "Optional Parts".

Using longer screws could damage the internal components of the Medi Client IIA system.

For VESA® mounting details, please observe the Fig. 31 and Fig. 32.

9.3.2. Outline Dimensions for Medi Client IIA 150

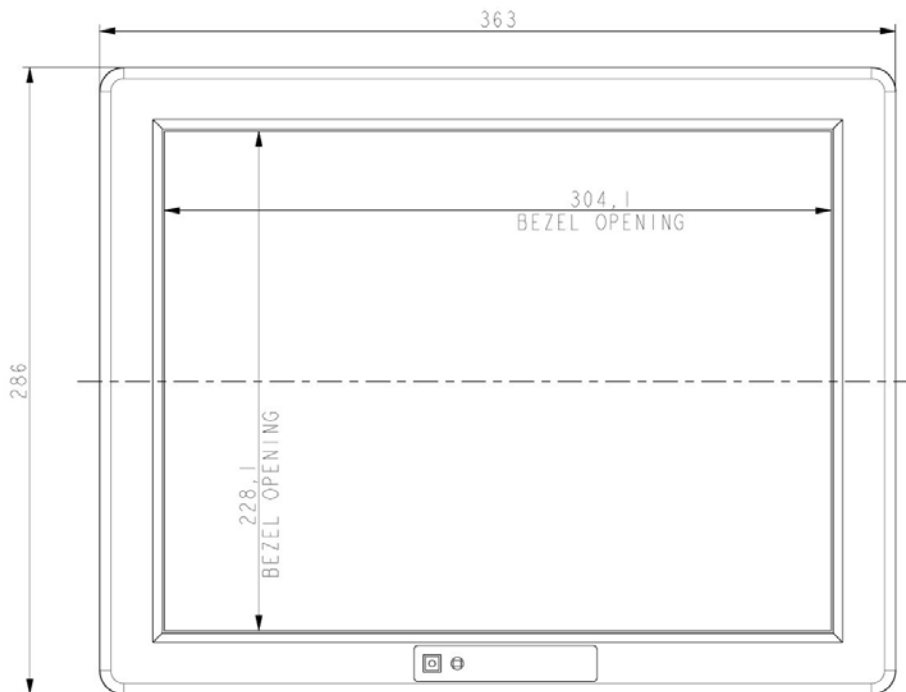

Fig. 33: Frontal view of the Medi Client IIA 150 system

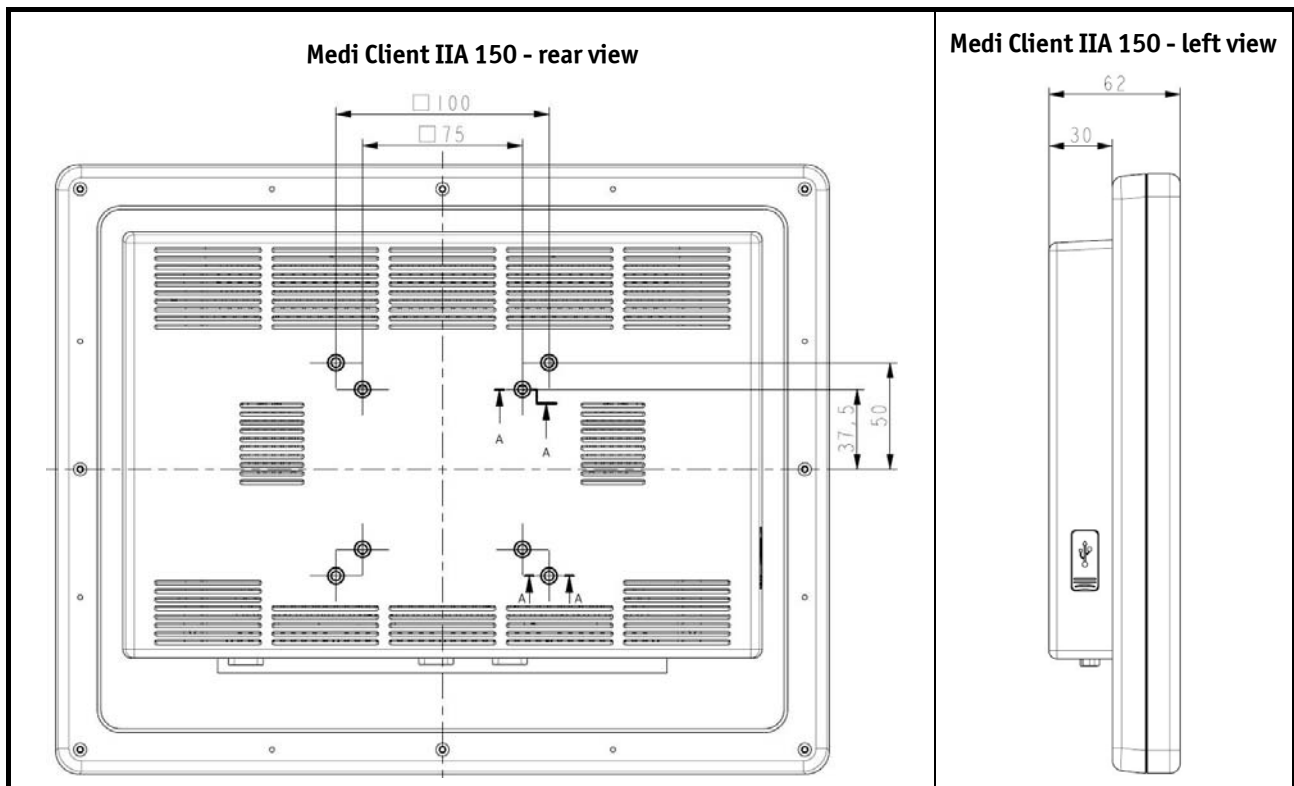

Fig. 34: Rear and left side view of the Medi Client IIA 150 system



Medi Client IIA 150 is VESA® 75/100 compliant.

Use four M4 metric screws to attach the system to a VESA® mounting system. Depending on the VESA® mounting system used, choose the length of the screws so that the screw-in depth of the screws should be between 4mm (0.16") up to 7mm (0.28"). For corresponding screws refer to the screw type included in the chapter 6.1 "Optional Parts".

Using longer screws could damage the internal components of the Medi Client IIA system.

For VESA® mounting details, please observe the Fig. 34 and Fig. 32.

9.4. CE Directives and Standards

CE Directives	
Low Voltage Directive (Electrical Safety)	2006/95/EC
EMC Directive	2004/108/EC
Medical Device Directive	93/42/EEC class 1 device
CE Marking	93/68/ECC

Electrical Safety	Standards
EUROPE	EN 60950-1: 2006 EN 60601-1 3 rd Edition: 2006
USA / Canada	UL 60950-1:2006 cULus Listed
CB Scheme	CB Certification

EMC	Standards
EN 55022: 2006	Emission of Information technology equipment – Radio disturbance characteristics – Limits and methods of measurement
EN 61000-3-2:2006	Limits - Limits for harmonic current emissions (equipment input current \leq 16 A per phase)
EN 61000-3-3:2006	Limitation of voltage changes, voltage fluctuations and flicker in public low-voltage supply systems, for equipment with rated current \leq 16 A per phase and not subjected to conditional connection
EN 61000-6-4: 2007	Generic standards - Emission standard for industrial environments
EN 61000-6-3: 2007	Generic standards – Emission standard for residential, commercial and light-industrial environments
EN 55024: 1998 + A1: 2001 + A2: 2003	Information technology equipment – Immunity characteristics – Limits and methods of measurement
EN 61000-6-2: 2005	Generic standards - Immunity for industrial environments (Immunity):
EN 55011: 2007	Industrial scientific and medical (ISM) radio-frequency equipment – Electromagnetic disturbance characteristics – Limits and methods of measurement
EN60601-1-2: 2007	Medical electrical equipment - General requirements for basic safety and essential performance - Collateral standard: Electromagnetic compatibility - Requirements and tests
U.S.A.	FCC 47 CFR Part 15, Class B
Canada	ICES-003

10. Interfaces - Pin Assignments

10.1.1. Power Connector

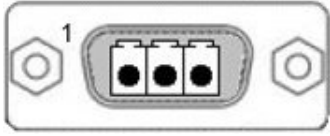
Pin	Signal Name	3-pin POWER SUBCON (male)
1	0V input (-24 VDC polarity on the unit panel)	
2	NC	
3	+24 VDC (input)	

10.1.2. USB Interfaces (USB)

Pin	Signal Name	4-pin USB Socket Type A Version 2.0/1.1
1	VCC	
2	Data-	
3	Data+	
4	GND	

10.1.3. Serial Port RS232

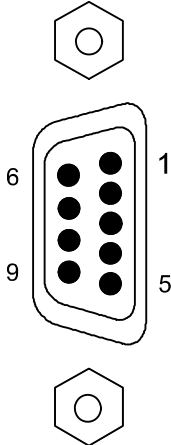
Pin	Signal Name	9-pin D-SUB Plug (male)
1	DCD (Data Carrier Detect)	
2	RxD (Receive Data)	
3	TxD (Transmit Data)	
4	DTR (Data Terminal Ready)	
5	GND (Signal Ground)	
6	DSR (Data Set Ready)	
7	RTS (Request to Send)	
8	CTS (Clear to Send)	
9	RI (Ring Indicator)	

10.1.4. Serial Port (RS422/RS485) configured as RS422 (4-Channel Mode)

Refer to the chapter 7.2.5.6 "Extension as RS422/RS485 Serial Interface Connector", Table 6, Table 7 and Table 8.

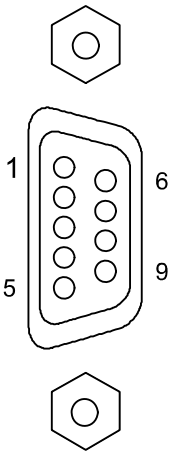
Pin	Signal Name	9-pin D-SUB Connector (female)
1	TxD- (Transmit Data-)	
2	RxD+ (Receive Data+)	
3	TxD+ (Transmit Data+)	
4	RxD- (Receive Data-)	
5	GND (Signal Ground)	
6	RTS- (Request to Send-)	
7	RTS+ (Request to Send+)	
8	CTS+ (Clear to Send+)	
9	CTS- (Clear to Send-)	

10.1.5. Serial Port (RS422/RS485) configured as RS485 (4-Wire Mode), full duplex, (Bus-Master)

Refer to the chapter 7.2.5.6 "Extension as RS422/RS485 Serial Interface Connector", Table 6, Table 7 and Table 8.

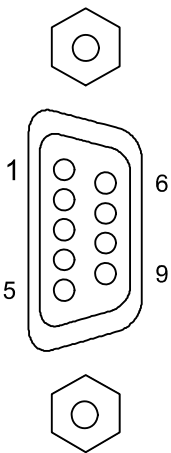
Pin	Signal Name	9-pin D-SUB Connector (female)
1	TxD- (Transmit Data-)	
2	RxD (Receive Data+)	
3	TxD+ (Transmit Data+)	
4	RxD- (Receive Data-)	
5	GND (Signal Ground)	
6	NC	
7	NC	
8	NC	
9	NC	

10.1.6. Serial Port (RS422/RS485) configured as RS485 (2-Wire Mode), half duplex

Refer to the chapter 7.2.5.6 "Extension as RS422/RS485 Serial Interface Connector", Table 6, Table 7 and Table 8.

Pin	Signal Name	9-pin D-SUB Connector (female)
1	Data-	
2	NC	
3	Data+	
4	NC	
5	GND (Signal Ground)	
6	NC	
7	NC	
8	NC	
9	NC	

10.1.7. CAN Connector

Refer to the chapter 7.2.5.7 "Extension as CAN BUS Interface", Table 9, Table 10 and Table 11.

Pin	Signal Name	9-pin D-SUB Connector (male)
1	NC	
2	CANL (galavic separated)	
3	CANOV (galavic separated)	
4	NC	
5	NC	
6	NC	
7	CANH (galavic separated)	
8	NC	
9	NC	
case GND		

10.1.8. VGA Port (VGA)

Pin	Signal Name	15-pin D-SUB Connector (female)
1	Analog red output	
2	Analog green output	
3	Analog blue output	
4	N.C.	
5-8	GND	
9	+5 V (DDC)	
10	GND	
11	N.C.	
12	SDA (DDC)	
13	TTL HSync	
14	TTL VSync	
15	SCL (DDC)	

11. Technical Support

For technical support, please contact our Technical Support department:

Tel: +49 (0) 8165/77 112
 e-mail: support-keu@kontron.com
 Web: <http://www.kontron.com/support>

Make sure you have the following information on hand when you call:

- the unit part id number (PN),
- the serial number (SN) of the unit; the serial number can be found on the type label, placed on the right side of the system.

Be ready to explain the nature of your problem to the service technician.

If you have questions about Kontron Europe or our products and services, you can reach us by the above-mentioned telephone number and on e-mail address or at: www.kontron.com.

11.1. Returning Defective Merchandise

Please follow these steps before you return any merchandise to Kontron Europe:

1. Download the corresponding form for returning a device with an RMA No. [RMA (Return of Material Authorization)] from our website www.kontron.com / Support / .RMA Information; contact our Customer Service department to obtain an RMA No.
 e-Mail: service@kontron.com
2. Ensure that you have received an RMA number from Kontron Customer Services before returning any device. Write this number clearly on the outside of the package.
3. Describe the fault that has occurred.
4. Please provide the name and telephone number of a person we can contact to obtain more information, where necessary. Where possible, please enclose all the necessary customs documents and invoices.
5. When returning a device:
 - Pack it securely in its original box.
 - Enclose a copy of the RMA form with the consignment.

Corporate Offices

Europe, Middle East & Africa	North America	Asia Pacific
Oskar-von-Miller-Str. 1 85386 Eching/Munich Germany Tel.: +49 (0)8165/ 77 777 Fax: +49 (0)8165/ 77 219 info@kontron.com	14118 Stowe Drive Poway, CA 92064-7147 USA Tel.: +1 888 294 4558 Fax: +1 858 677 0898 info@us.kontron.com	17 Building,Block #1,ABP. 188 Southern West 4th Ring Beijing 100070, P.R.China Tel.: + 86 10 63751188 Fax: + 86 10 83682438 info@kontron.cn