

# » Kontron User's Guide «

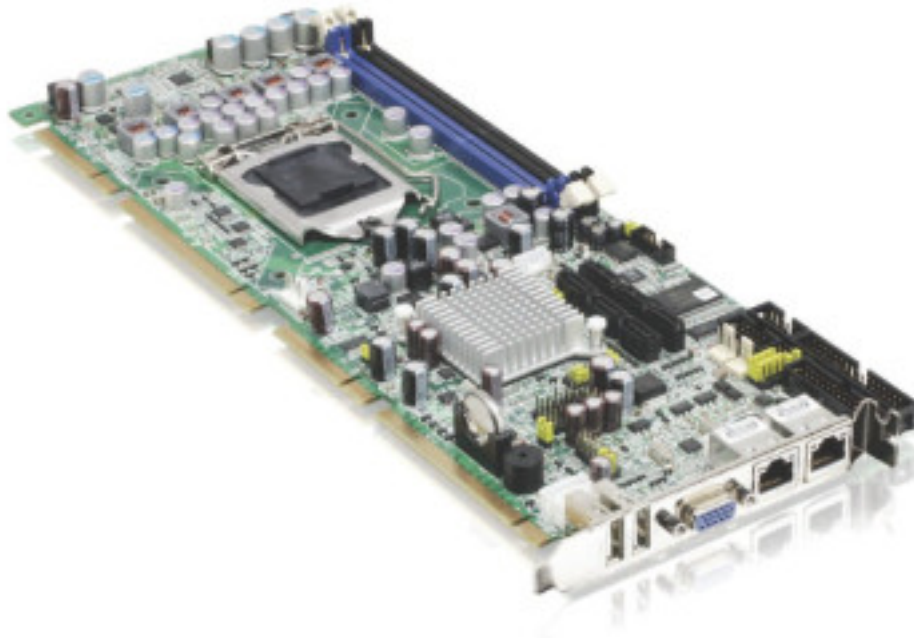

## PCI-760

**User's Guide** (Version V1.10)  
0-0096-4163

This page is intentionally left blank.

# 1. Table of Contents

<b>1. Table of Contents</b> .....	<b>1</b>
1.1. Table of Figures.....	2
<b>2. Introduction</b> .....	<b>3</b>
2.1. Symbols used in this Manual .....	4
<b>3. Safety Instructions</b> .....	<b>5</b>
3.1. Safety Instructions for the Lithium Battery .....	5
3.2. Basic Safety and EMC Compatibility .....	5
<b>4. Important Instructions</b> .....	<b>6</b>
4.1. Electrostatic Discharge (ESD) .....	6
4.2. Note on the Warranty.....	6
4.3. Exclusion of Accident Liability Obligation.....	6
4.4. Liability Limitation / Exemption from the Warranty Obligation .....	6
4.5. General Instruction on Usage .....	6
<b>5. Scope of Delivery</b> .....	<b>7</b>
5.1. Labeling Information .....	7
<b>6. Features</b> .....	<b>8</b>
<b>7. Functional Diagram</b> .....	<b>13</b>
<b>8. Memory Installation</b> .....	<b>14</b>
<b>9. Jumpers and Connectors Overview</b> .....	<b>15</b>
9.1.1. Connectors located on Slot Bracket .....	18
9.1.2. Jumpers on the PCI-760 .....	20
9.1.3. Connectors On-Board .....	22
9.1.4. PICMG 1.3 Connector (Edge Connector) PCI Express and PCI(-X) Interfaces .....	32
9.1.5. Lithium Battery .....	36
<b>10. AMI BIOS Configuration</b> .....	<b>37</b>
10.1. BIOS Setup.....	37
10.1.1. Navigation .....	37
10.2. Main.....	38
10.2.1. System Time / System Date.....	38
10.3. Advanced.....	40
10.3.1. CPU Configuration (Configure advanced CPU settings) .....	41
10.3.2. IDE Configuration.....	42
10.3.3. AHCI Configuration (AHCI Settings).....	48
10.3.4. Super IO Configuration (Configure Win627 Super IO Chipset) .....	49
10.3.5. USB Configuration.....	51
10.3.6. Event Log Configuration (Event Logging details) .....	53
10.3.7. Remote Access Configuration (Configure Remote Access type and parameters) .....	54
10.3.8. ACPI Configuration.....	56
10.3.9. MPS Configuration .....	59
10.3.10. Trusted Computing.....	59
10.3.11. ASF Configuration .....	60
10.3.12. Intel AMT Configuration [Configure Intel AMT Parameters] .....	60
10.3.13. Intel TXT (LT) Configuration [Configure Intel TXT (LT) Parameters] .....	61
10.3.14. Intel VT-d Configuration .....	61
10.3.15. Intel VA Configuration (Configure Intel VA Parameters).....	61
10.4. PCIPnP .....	62
10.5. Boot .....	65
10.6. Security.....	69

10.6.1. Supervisor Password .....	69
10.6.2. User Password .....	69
10.7. Chipset .....	72
10.7.1. North Bridge Chipset Configuration .....	72
10.7.2. South Bridge Chipset Configuration .....	75
10.7.3. ME Subsystem Configuration .....	77
10.8. Exit .....	79
10.8.1. Save Changes and Exit .....	79
10.8.2. Discard Changes and Exit .....	79
10.8.3. Discard Changes .....	79
10.8.4. Load Optimal Defaults .....	79
10.8.5. Load Failsafe Defaults .....	79
<b>11. Technical Data .....</b>	<b>80</b>
11.1. Electrical Specifications .....	81
11.2. Mechanical Specifications .....	81
11.3. Environmental Specifications .....	81
11.4. CE Directives .....	81
<b>12. Technical Support .....</b>	<b>82</b>
12.1. Returning Defective Merchandise .....	82

## 1.1. Table of Figures

Fig. 1: PCI-760 board .....	7
Fig. 2: PCI-760 – Functional diagram .....	13
Fig. 4: PCI-760 - Detail for jumpers and connectors located near the CMOS battery .....	17
Fig. 5: PCI-760 – Slot Interfaces .....	18
Fig. 6: Placement of the battery .....	36

## 2. Introduction

Kontron Embedded Computers would like to point out that the information contained in this manual may be subject to technical changes, particularly as a result of continuous upgrades.

The attached documentation does not entail any guarantee on the part of Kontron Embedded Computers with respect to technical processes described in the manual or any product characteristics set out in the manual. Kontron Embedded Computers does not accept any liability for any printing errors or other inaccuracies in the manual unless it can be proven that Kontron Embedded Computers is aware of such errors or inaccuracies or that Kontron Embedded Computers is unaware of these as a result of gross negligence and Kontron Embedded Computers has failed to eliminate these errors or inaccuracies for this reason.

Kontron Embedded Computers expressly informs the user that this manual only contains a general description of technical processes and instructions which may not be applicable in every individual case. In cases of doubt, please contact Kontron Embedded Computers.

This manual is protected by copyright. All rights are reserved by Kontron Embedded Computers. Copies of all or part of this manual or translations into a different language may only be made with the prior written consent of Kontron Embedded Computers. Kontron Embedded Computers points out that the information contained in this manual is continuously being updated in line with the technical alterations and improvements made by Kontron Embedded Computers to the products and thus this manual only reflects the technical status of the products at the time of printing. Updated versions are available on the Kontron web page: [www.kontron.com](http://www.kontron.com).



© 2011 by Kontron Embedded Computers

Printing and duplication, even of sections, is only permissible with the express approval of

Kontron Embedded Computers GmbH  
Oskar-von-Miller-Str. 1

85386 Eching  
Germany

## 2.1. Symbols used in this Manual

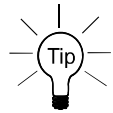
Symbol	Meaning
	This symbol indicates the danger of injury to the user or the risk of damage to the product if the corresponding warning notices are not observed.
	This symbol indicates that the product or parts thereof may be damaged if the corresponding warning notices are not observed.
	This symbol refers to general information on the device and manual.
	This symbol comes before useful information and tips for routine operation.
<i>format a:</i>	Commands are printed in <i>Courier</i> .

© Microsoft, MS-DOS, Windows and Windows NT are registered trademarks of the Microsoft Corporation.

© IBM, PC-AT, OS/2 and PS/2 are registered trademarks of the International Business Machines Corporation.

© Intel and Pentium are registered trademarks of Intel Corporation.

© AMI is a registered trademark of American Megatrends, Inc.

Other product names cited in this manual may also be trademarks and are used here solely for identification purposes.

## 3. Safety Instructions

### 3.1. Safety Instructions for the Lithium Battery

The PCI-760 board is equipped with a Lithium battery. For the replacing of this battery please observe the instructions described in the chapter 9.1.5.1 "Replacing the Lithium Battery".



**Caution!**

Danger of explosion when replaced with wrong type of battery. Replace the battery only with UL recognized Lithium battery that has the same or equivalent type recommended by Kontron.



Do not dispose of lithium batteries in domestic waste. Dispose of the battery according to the local regulations dealing with the disposal of these special materials (e.g. to the collecting points for the disposal of batteries).

### 3.2. Basic Safety and EMC Compatibility

The PCI-760 board is a fixed component that shall be installed into a stationary system by applying good engineering practices and respecting the information on the intended use of the components with a view to meeting the protection requirements [refer to (a) and (b)].

The PCI-760 board was designed and manufactured, having regard to the state of the art, as to ensure that:

(a) the electromagnetic disturbance generated does not exceed the level above which radio and telecommunications equipment or other equipment cannot operate as intended;

(b) it has a level of immunity to the electromagnetic disturbance to be expected in its intended use which allows it to operate without unacceptable degradation of its intended use.

The PCI-760 board was designed, manufactured and checked according to the basic safety requirements in the scope of the low-voltage (LVD) directive.

## 4. Important Instructions

The manufacturer's instructions provide useful information on your PCI-760 board.



### 4.1. Electrostatic Discharge (ESD)

The components on the board are sensitive to static electricity. Care must therefore be exercised at all times during handling and inspection of the PCI-960 board, in order to ensure the product integrity.

- Do not handle this product while it is outside its protective enclosure, while it is not used for operational purposes, unless it is otherwise anti-static protected.
- Unpack or install this product only at EOS/ESD safe workstations. When safe work station are not guaranteed, it is important for the user to be electrically discharged before touching the PCI-960 board with his/her hands or tools. This is most easily done by touching a metal part of your system housing.
- Only hold the assemblies at the edge.
- Do not touch any connection pins or conductors on the assembly.

### 4.2. Note on the Warranty

Due to their limited service life, parts which, by their nature, are especially subject to wear (wearing parts) are not included in the guarantee beyond the legal stipulations. This applies to the batteries, for example.

### 4.3. Exclusion of Accident Liability Obligation

Kontron Embedded Computers shall be exempted from the statutory accident liability obligation if the user fails to observe the safety instructions.

### 4.4. Liability Limitation / Exemption from the Warranty Obligation

In the event of damage to the device caused by failure to observe the hints in this manual and eventually on the device (especially the safety instructions), Kontron Embedded Computers shall not be required to honor the warranty even during the warranty period and shall be exempted from the statutory accident liability obligation.

### 4.5. General Instruction on Usage

In order to ensure safe operation, the user must observe the instructions and warnings contained in this manual.

Kontron Embedded Computers can only guarantee the safety, reliability and performance of the board if following instructions are observed.

- The PCI-760 board must be used in accordance with the instructions for use.
- The PCI-760 board is designed to be built-in to a system, which fulfill all necessary technical and environmental requirements.
- When installing the board into a system, ensure that the system is switched off and the systems power cord is disconnected from the power source. Disconnect all cable connections of peripheral devices from the system.
- Ensure that the DC operating voltages adheres to the specification given in the "Electrical Specifications".
- Only devices and components which fulfill the requirements of a SELV circuit (security extra low voltage) in accordance with IEC / EN 60950-1 may be connected to the interfaces of the PCI-760 board.
- If extensions are made to the PCI-760 board, the legal stipulations and the board specifications must be observed.



## 5. Scope of Delivery

Please check that your package is complete, and contains the items below (according to the ordered unit configuration).  
If you discover damaged or missing items, please contact your dealer.

- 1x PCI-760 SBC (Single Board Computer) PICMG 1.3 (full-size)
- General Safety Instructions for Boards

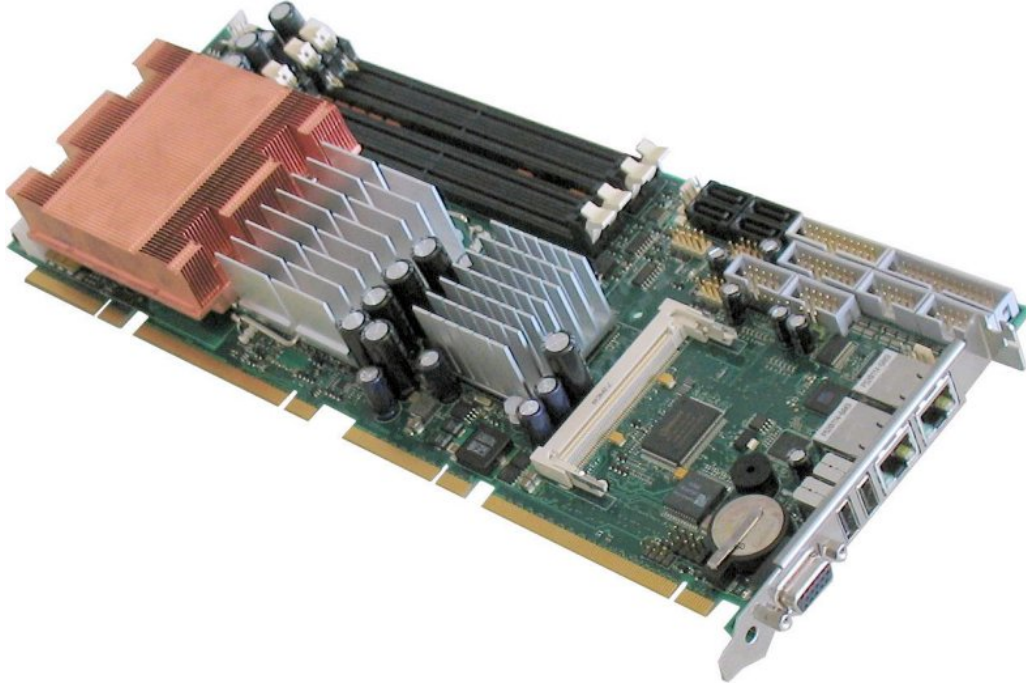

Fig. 1: PCI-760 board

### Optional

- 1x Cable Set (Accessories)
- Option: USB-Flash-Module-Intel® Z-U130  
For more information refer to: [www.intel.com](http://www.intel.com)

### 5.1. Labeling Information

Two types of printed labels on the PCI-760 board must show the following information:

1. Board identification label that has implemented: Board Designation/Serial Number/Part Number/Product Revision/QM-Field/Bar Code/Datamatrix Code
2. 4x MAC-Address Label

## 6. Features

### Form Factor:

- Full size SHB PICMG 1.3 form factor (13.33 x 4.98 inch).

### Processor (CPU):

Intel® Core™ 2 Duo/Quad, 65 nm (Desktop)

- 800/1066/1333 MHz FSB (**F**ront **S**ide **B**US)
- LGA775
- 2MB/4MB/8MB, L2 Cache (depending on the installed CPU)

**Processor Socket:** LGA 775 (using LGA 771 heat sink)

### Memory

- Dual-Channel DDR2 memory architecture, un-buffered, non-ECC
- 4x DDR2 DIMM 240-pin slots for up to 8GB 667/800 MHz DDR2 SDRAM (use please: PC2-5300 and/or PC2-6400)
- Memory type: 512Mb, 1Gb DDR2 DRAM technologies

**Chipset:** Intel® ICH9DO + Q35 GMCH (**G**raphics **M**emory **C**ontroller **H**ub)

**I/O Controller Hub:** Intel® 82801IO [ICH9 Digital Office (ICH9DO)]

- PCI Express: 5 PCI Express (PCIe) root ports (PCI Express specification Rev. 1.1)
- Integrated Serial ATA Host Controller: up to six SATA ports; Data transfer rates up to 3.0 Gb/s (300 MB/s)
- External SATA support including eSATA port multiplier
- Intel® Matrix Storage Technology
  - Configures the SATA controller as a RAID controller (RAID 0/1/5/10)
- USB 2.0
  - Six UHCI Host Controllers, supporting up to twelve external ports
  - Two EHCI Host Controllers, supporting up to twelve external ports
  - Two Configuration Options for EHCI Controllers 6+6 and 8+4
  - Per-Port-Disable Capability
  - Includes up to two USB 2.0 High-speed Debug Ports
  - Supports wake-up from sleeping states S1–S5
  - Supports legacy Keyboard/Mouse software
- Intel® Active Management Technology with System Defense



For Information refer to Intel® Active Management Technology.

- Features and Benefits** Out-of-band system access
- Remote trouble-shooting and recovery
- Hardware-based agent presence checking
- Proactive alerting
- Remote hardware and software asset tracking

“Intel® Active Management Technology (Intel® AMT) requires the computer system to have an Intel® AMT-enabled chipset, network hardware and software, as well as connection with a power source and a corporate network connection. Setup requires configuration by the purchaser and may require scripting with the management console or further integration into existing security frameworks to enable certain functionality. It may also require modifications of implementation of new business processes.”

- Intel® I/O Virtualization (VT-d) support
- Intel® Trusted Execution Technology support
- Power Management Logic
  - Supports ACPI 3.0b
  - ACPI-defined power states C1, C2, S1, S3–S5 for Desktop
- Enhanced DMA Controller
- SMBus
  - Faster speed, up to 100 kbps
  - Supports SMBus 2.0 Specification
- High Precision Event Timers
- Timers Based on 82C54
- Real-Time Clock
  - 256-byte battery-backed CMOS RAM
- System TCO Reduction Circuits

#### **Internal Graphics: Intel® GMA 3100 (Graphics Media Accelerator)**

- Max memory allocation support based on total system memory
- 400-MHz integrated RAMDAC that can drive a standard progressive scan analog monitor with a resolution of up to 2048x1536 pixel (QXGA)
- Dedicated CRT interface with data-interface control: (15-pin D-SUB connector on I/O panel)

#### **Integrated Audio:**

- Integrated HDA (High Definition Audio) controller (ICH9DO) with ALC882 Codec
  - Meets performance requirements for audio on PC2001 systems
  - 10 DAC channels support 16/20/24-bit PCM format for 7.1 sound playback
  - DACs (Digital-to-Analog Converter) support 44.1k/48k/96k/192kHz
  - ADCs (Analog-to-Digital Converter) support 44.1k/48k/96kHz
  - 16/20/24-bit S/PDIF-OUT supports 44.1k/48k/96k/192kHz sample rate
  - 16/20/24-bit S/PDIF-IN supports 44.1k/48k/96k/192kHz sample rate
  - Backward compatibility with AC'97
  - Built-in headphone amplifiers
  - Meets Microsoft WHQL/WLP 2.0 audio requirements
  - EAX™ 1.0 & 2.0 compatible
  - Direct Sound 3D™ compatible
  - Microphone Acoustic Echo Cancellation (AEC),
  - Noise Suppression (NS) technology for voice application
- On board audio ports:
  - Line-In, Line-Out and Microphone-In available on boxed header on board
  - Surround L/R, Side Surround L/R and Center/LFE available on boxed header on board
  - SPDIF-In and SPDIF-Out header on board for coaxial and/or optical fiber connection via an adapter cable with slot mounting bracket (not included)

**Networking:**

- **Intel® 82566DM (ICH9DO)** Ethernet controller that supports the LAN1 interface [RJ45 connector on I/O panel with integrated LEDs (LED with three signal outputs)]
  - Compliant with IEEE 802.3ab
  - LAN Connect Interface (LCI) and Gigabit LAN Connect Interface (GLCI)
  - 10/100/1000 Mbps Ethernet Support
  - Jumbo Frame Support
  - Automatic MDI Crossover
  - Wake-on-LAN
  - supports Teaming
- **Realtek RTL8111B** PCI Express Controller (via internal PCIe x1 Link of ICH9DO) that supports the LAN2 (RJ45 connector on I/O panel with integrated LEDs)
  - Compliant with IEEE 802.3u, IEEE 802.3ab
  - 10/100/1000 Mbps Ethernet Support
  - Crossover Detection & Auto-Correction
  - Configurable 48 KB deep buffer
  - Wake-on LAN (WOL)
- **Realtek 8110SC** Gigabit Ethernet Controller for PCI 32bit, 33MHz
  - Compliant with IEEE 802.3u, IEEE 802.3ab
  - Routed to the PICMG1.3 edge connector
  - 10/100/1000 Mbps Ethernet Support
  - Crossover Detection & Auto-Correction
  - Wake-on-LAN (WOL)

**Super-I/O**

- Winbond W83627HF with integrated hardware monitor
  - Compliant with Microsoft PC98/PC99 Hardware Design Guide
  - LPC-based Super-I/O
  - On board ports: 2x COM, 1x LPT, PS/2-Keybaord, PS/2 Keyb.-Lock and PS2-Mouse, Watchdog, Hardware-Monitoring, Suspend-LED

**Hardware Monitor, Temperature Monitor**

- Chassis Intruder, via ICH9DO
- Monitoring of 3 fan tachometer outputs
- Fan control outputs, maximum current: 750mA each
- Monitoring of two board temperatures (core voltage regulator and DDR2-DIMM sockets)
- Remote diode temperature sense for the CPU temperature
- Voltage sense for +5V, +12V, +3.3V, +1.8 V, CPU coreA/B (1.05V), VBAT, +5VSB, +3.3VSB

**Serial ATA (SATAII)**

- Four 7-pin connectors (lockable connectors) on board and two interface connections routed to the PICMG1.3 edge connector.
- Data transfer rate up to 300 Mbps on each port
- RAID 0/1/5/10 functionality with ICH9DO

## USB Ports

Twelve USB 2.0 Port (USB0 – USB11):

- Two ports on the I/O slot bracket,
- Six ports on board
- Four USB signals routed to the PICMG1.3 edge connector
  - Maximum continuous load current per port: 500mA
  - Typical short-circuit current at 25°C: 900mA
  - Overcurrent indicators
  - Wake-up capability on the USB ports; The USB devices are supplied with standby power.

## Serial Communication Ports

Two high-speed 16550 compatible UARTs with 16-byte send/receive FIFOs

- The serial ports support RS232 (COM1, COM2); COM2 is configurable RS422, RS485
- Fully programmable serial-interface characteristics
- Programmable baudrate up to 115kbit/s
- The pin 10 of the serial ports delivers 12V fused
- The serial ports have wake-up capability from any sleep state.

## Parallel Port

One bi-directional LPT port, which is configurable for standard LPT

- Support Enhanced Parallel Port (EPP) - Compatible with IEEE 1284 specification
- Support Extended Capabilities Port (ECP) - Compatible with IEEE 1284 specification

## Keyboard and Mouse

Interfaces (7-pin header on board) to standard AT keyboard and PS/2 mouse

- 8042 based with F/W from AMIKKEY
- Fast Gate A20 and Hardware Keyboard Reset
- Support port 92
- Keyboard Wake-up by programmable keys
- Mouse Wake-up by programmable buttons

## PS/2 Keyboard Lock

2-pin row on board for PS/2 keyboard lock

## Multifunction Connector

- One hard drive activity LED for all HDD devices
- Power LED
- PS/2 Keyboard & PS/2 Mouse
- Reset

## Connector for Power Buttons

- 2-pin connector for additional power button



### Power Button Control:

If an ATX power supply is used, the SBC can control it either through:

- the backplane via PICMG 1.3 edge connector or
- its additional power button connector (J34) or
- the hardware monitor connector (J7) power button (PWRBT#) input.

### PCI -Support

- up to five PCI-Masters, 32-bit/33 MHz according to PCI Specification v2.3 for:
  - one PCI-Master on board: optional single MiniPCI connector, type IIIA; signaling 3.3 V (installed Mini PCI card must be 5 V tolerant)



Hint for the optional MiniPCI connector: the additional USB signals on reserved pins **for e. g. bluetooth are not supported.**

- up to four PCI-Masters routed to the PICMG 1.3 edge connector  
Supports 5V PCI backplanes
- PCI Express routed to the PICMG 1.3 edge connector
  - 4x PCIe x1 or 1x PCIe x4
  - 1x PCIe x16

### Real Time Clock (RTC)

Motorola MC146818B-compatible RTC with 256 bytes of battery-backed RAM

- RTC supports a date alarm that allows for scheduling a wake-up event up to 30 days in advance
- A coin-cell battery (CR2032) powers the real-time clock and CMOS memory
- A battery socket eases replacing empty batteries
- Battery backup time > 5 years
- Accuracy better than 50ppm (max. deviation 4s/24 hours) within the whole temperature range

### BIOS

The BIOS is based on the AMI BIOS Core Release 8.00.14.

- 4 MB (32MBit), Flash BIOS-ROM connected to the SPI-Bus
- Upgradeable via Flash updating tool
- PXE-Boot
- Legacy USB Support including USB 2.0
- Support of Serial Ports (RS232, serial console redirection); COM2 configurable as RS422 and RS485
- Support of VGA (CRT)
- ACPI Support
- Hardware Monitoring

### Power and System Management

- BIOS-support for CPU-Internal temperature-sensor/s
- Power management according to ACPI 3.0
- Three Fan controls, additional four FAN-Tacho inputs available on Hardware Monitor Connector
- Supports Full-on (S0), Suspend (S1), Suspend-To-RAM (S3), Suspend-To-Disk (S4) and Soft-Off (S5).
- Wake-up events
- Optional customized logo in boot-screen feature

# 7. Functional Diagram

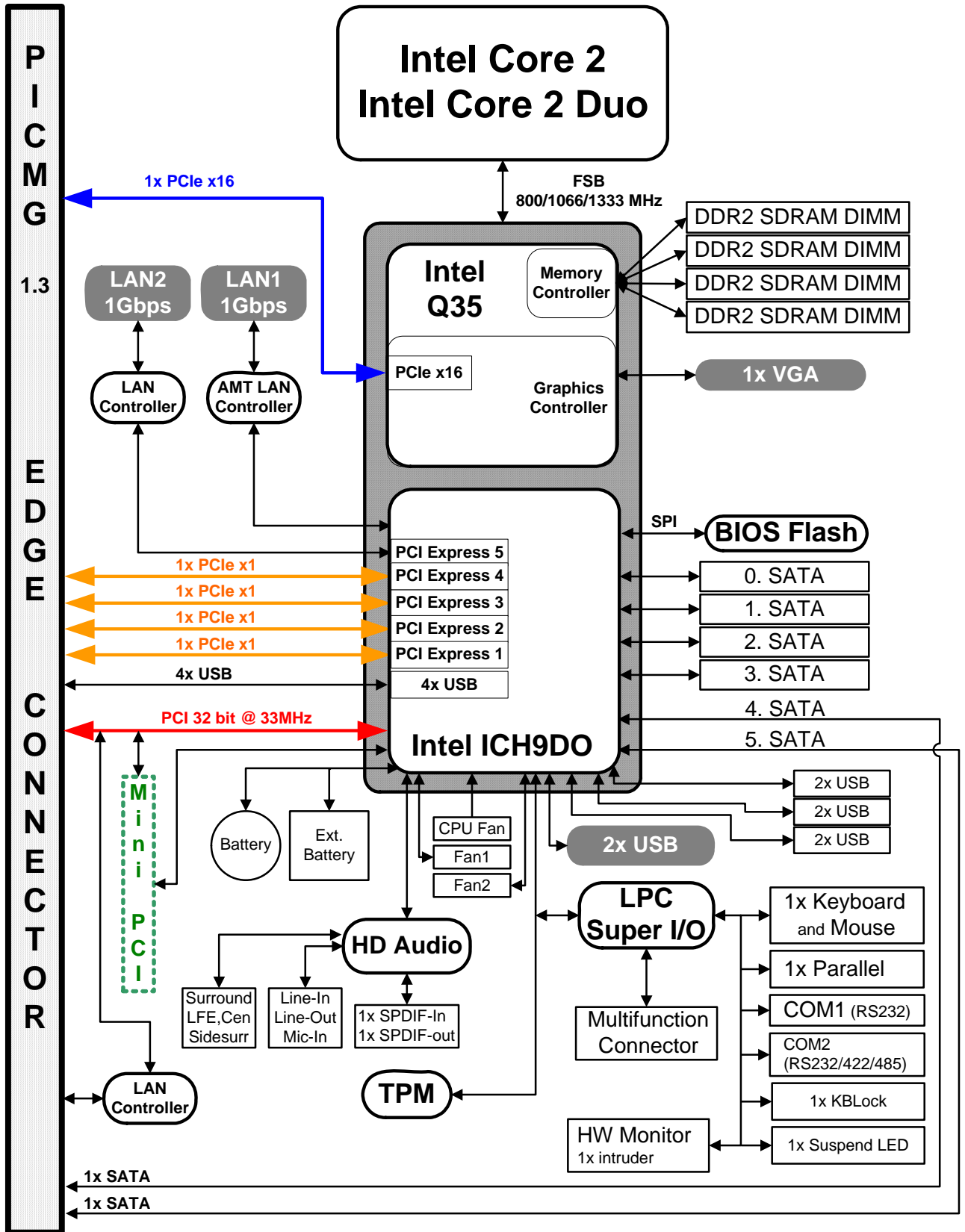

**Legend:**  On board connectors  
 External interfaces  
 Option

Fig. 2: PCI-760 – Functional diagram

## 8. Memory Installation

The PCI-760 board supports four DDR2 DIMM sockets (240-pin) for up to a total memory of up to 8GB DDR2 SDRAM. The single/double sided memory modules can be user-defined combined in sizes of 256MB, 512MB up to max. 2GB per DDR2 DIMM-socket.



The majority of systems supporting dual-channel memory can be configured in either single-channel or dual-channel memory mode.

The speed used in all channels is the speed of the slowest DIMM in the system.

Only around a memory of 3.5 GB is usable for most of 32 bit operating systems.

DIMM0 (nearest positioned to the CPU) must be fitted first for AMT and QST feature.

For the best dual-channel memory performance on boards with the Intel dual-channel DDR2 chipsets must be used identically paired memory modules in channel A and B.

We recommend installing into the board DDR2 DIMM sockets a dual channel kit (identically manufacturer, capacity, speed, number of chips and modules).

### Prerequisites for dual-channel memory configuration:

1. Both modules are the same capacity (e.g. both are 256MB or 512MB)
2. Both modules are the same speed (e.g. both are PC2700 or PC3200)
3. Both have the same number of chips and module sides (e.g. both have the same number of chips on the module, and both are either single-sided or double-sided).

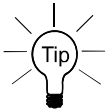

If other memory configuration is used, the system will revert to the single-channel memory mode (lower-performing mode).

The speed of the bus clock and the timing of the memory access for the whole main memory (RAM) are given by the slowest DDR2 DIMM Module built-in the system.



## 9. Jumpers and Connectors Overview

The jumpers and connectors of the PCI-760 board will be described in detail below.



Signals suffixed by a pound (#) are active-low.

All headers will have a pitch of 0.100" (2.54mm), otherwise noted different.

<b>Connectors on the I/O Panel</b>	
J36	VGA Connector
J25	LAN1 Connector
J26	LAN2 Connector
J29	USB7 Connector
J30	USB6 Connector
<b>On-Board Jumpers</b>	
JP1	COM2 (RS422) Enable Termination Resistors
JP2	COM2 (RS485/422) Enable Termination Resistors
JP3	Conn. for Ext. Temp. Sensor (not supported)
JP4	Always POWER ON (not supported)
JP5	RTC Reset (Clear CMOS)
JP6	Disable Backup Restore Function
JP7	TPM Physical presence (reserved)
JP8	Image Flash; BIOS programming (before BIOS update contact our Technical Support Department)
JP9	Reset Management Engine (reserved)
JP10	Enable/Disable the HDACT LED of the USB Flash Module
<b>On-Board Connectors</b>	
J1, J4, J24	12V Fan Connectors (3-pin)
J31	12V ATX Power Connector (4-pin)
J14	Multifunctional Connector (16-pin)
J15	Serial Connector COM1 (10-pin)
J16	Serial Connector COM2 (10-pin)
J8	Parallel Connector LPT (26-pin)
J22	SPDIF-IN&-Out Connector (5-pin)
J32	Keyboard Lock Connector (2-pin)
J33	Suspend-LED (2-pin)
J34	Additional Power Button Connector (2-pin)
J20	Audio Connector (10-pin) (Line-in, Line-out, Mic.)
J23	Audio Connector (10-pin) (Surround L/R, Side surround L/R, Center/LFE)
J13	USB header (USB4+USB5) (9-pin+key)
J19	USB header (USB8+USB9) (9-pin+key)
J10	USB header (USB10+USB11) (9-pin+key)
J5	SATA0 Connector
J11	SATA1 Connector
J6	SATA2 Connector
J12	SATA3 Connector
J28	MiniPCI Connector (124-pin)
J3	DDR2 DIMM Connector (240-pin) Channel B Bank 1
J9	DDR2 DIMM Connector (240-pin) Channel B Bank 0
J17	DDR2 DIMM Connector (240-pin) Channel A Bank 1
J18	DDR2 DIMM Connector (240-pin) Channel A Bank 0
BAT1	Lithium Battery Socket
J35	Ext Battery Connector (option)
J21	Keyboard&Mouse Connector
J7	Hardware Monitor Connector (20-pin)
J2	Extended Debug Port (XDP) Connector (reserved) [is located on the bottom side]
J27	CPU Socket
J41	Connector for Temp. Sensor (factory fitted with Temperature Sensor)

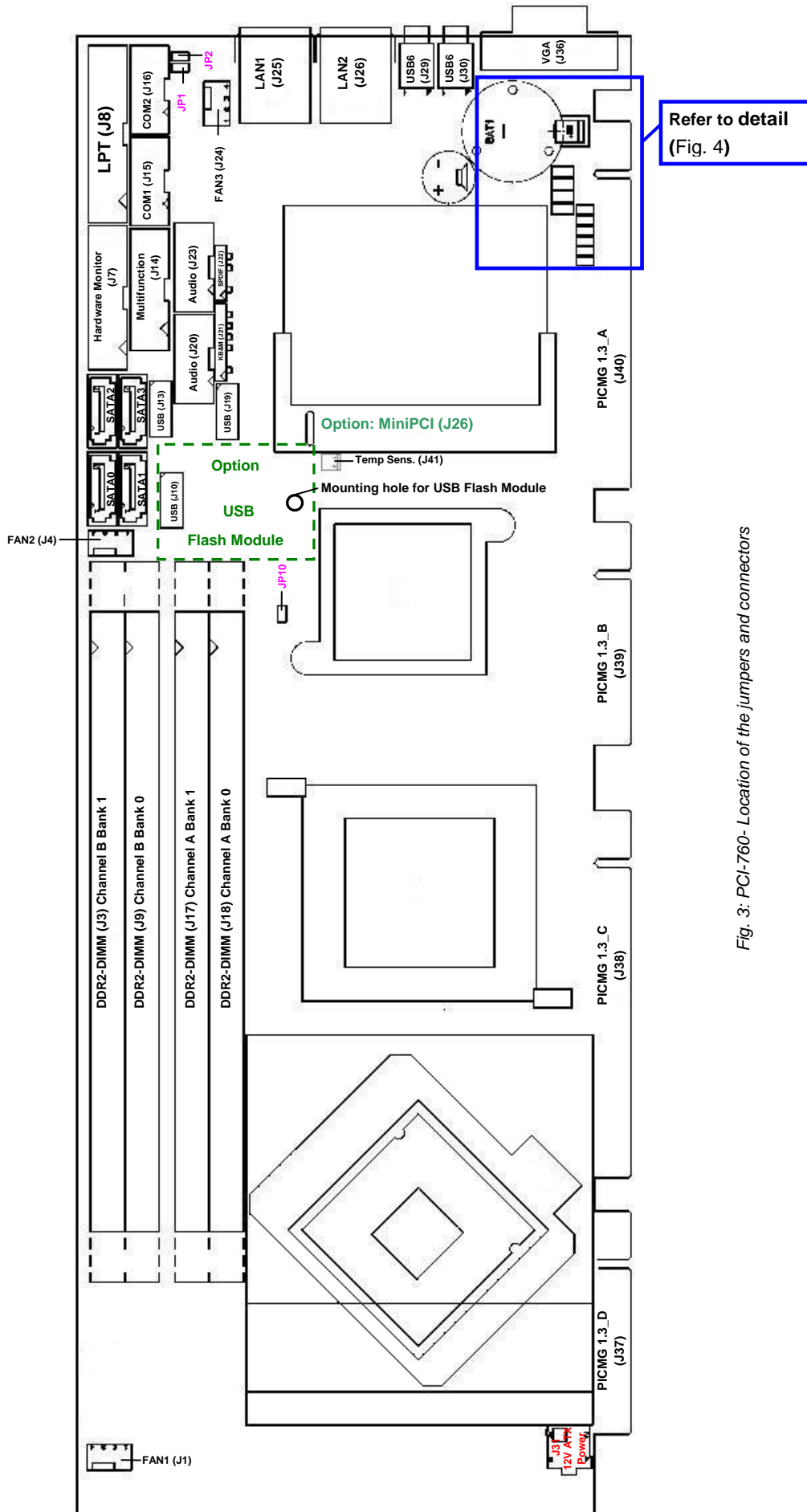

Fig. 3: PCI-760- Location of the jumpers and connectors

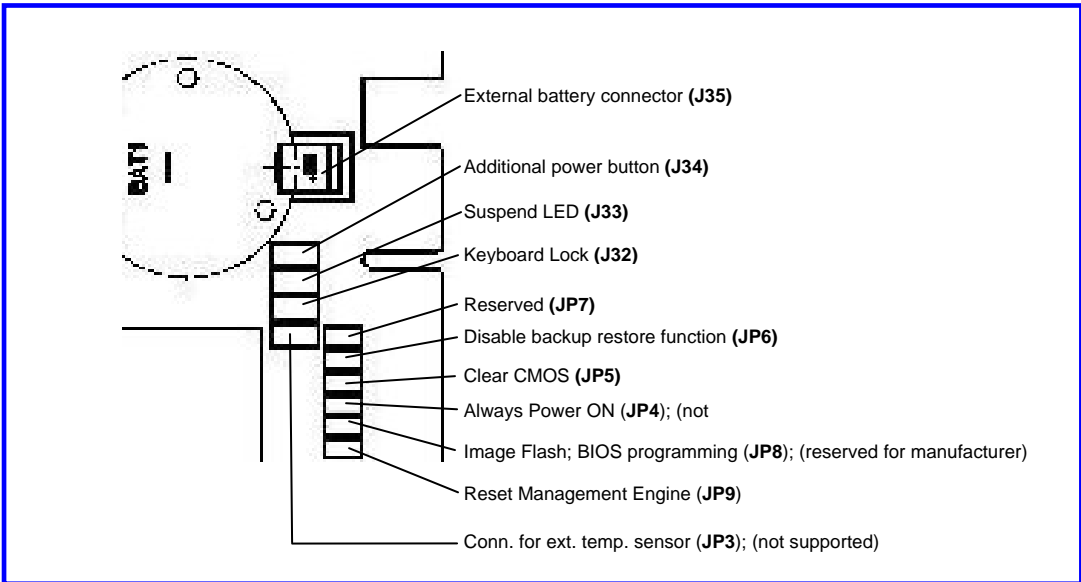

Fig. 4: PCI-760 - Detail for jumpers and connectors located near the CMOS battery

**9.1.1. Connectors located on Slot Bracket**

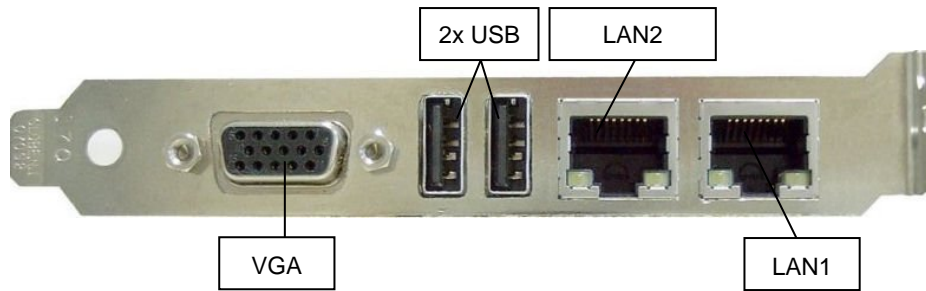

Fig. 5: PCI-760 – Slot Interfaces

**9.1.1.1. J29 and J30 USB Connectors**

The slot bracket of the PCI-760 board provides two external USB 2.0/1.1 interfaces (USB6 and USB7). These connectors allow connection of USB-compatible devices to the PCI-760 board (slot bracket).

Pin	Signal Name	4-pin USB Socket Type A Version 2.0/1.1
1	VCC, fused	
2	Data-	
3	Data+	
4	GND	

**9.1.1.2. J36: VGA Connector**

An external (analog) monitor can be plugged into this interface which is provided as a 15-pin D-SUB socket.

Pin	Signal Name	15-pin D-SUB Socket (female)
1	Analog red output	
2	Analog green output	
3	Analog blue output	
4	NC	
5-8	GND	
9	VCC, fused for DDC	
10	GND	
11	NC	
12	SDA (DDC)	
13	TTL HSync	
14	TTL VSync	
15	SCL (DDC)	

**9.1.1.3. J25 and J26: Gigabit LAN Connectors**

The slot bracket of the PCI-760 board is equipped with two LAN connectors. These interface connectors are provided as RJ45-sockets with integrated LEDs. The data transfer rate for the LAN communication is up to 10/100/1000Mbps.

Only the LAN1 interface (via LAN controller Intel 82566DM) provides the Intel® AMT (Active Management Technology). For more information about advanced features of AMT refer to “Intel® Active Management Technology”.

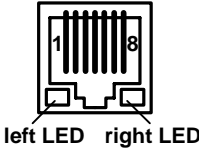
Pin#	Signal Name	J25: LAN1 [RJ45 (female)]
1	MDI0+	
2	MDI0-	
3	MDI1+	
4	MDI2+	
5	MDI2-	
6	MDI1-	
7	MDI3+	
8	MDI3-	

Speed (Mbps)	LAN1: LED Indicators		
	LED left		LED right
	LINK	ACTIVE	
10	on	orange on (blinking)	off
100	on	orange on (blinking)	green
1000	on	orange on (blinking)	orange

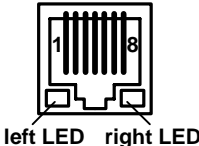
Pin#	Signal Name	J26: LAN2 [RJ45 (female)]
1	MDI0+	
2	MDI0-	
3	MDI1+	
4	MDI2+	
5	MDI2-	
6	MDI1-	
7	MDI3+	
8	MDI3-	

Speed (Mbps)	LAN2: LED Indicators		
	LED left		LED right
	LINK	ACTIVE	
10	off	orange on (blinking)	off
100	off	orange on (blinking)	green
1000	off	orange on (blinking)	orange



### 9.1.2. Jumpers on the PCI-760

The jumpers on the PCI-760 allow you to configure your CPU card according to the needs of your applications.



In order to change a jumper setting, turn off the computer using the ATX-power supply switch. If your power supply has no On/Off switch, disconnect the main power source. The board otherwise could be damaged.

The following examples show the conventions used in this section.

1  2	Jumper Open
1  2	Jumper Closed

#### 9.1.2.1. JP1 and JP2: Jumpers for COM2 Configuration as RS422 or RS485



The serial port COM2 (RS232 default setting) can be configured in the BIOS setup RS422 or RS485.



The jumpers JP1 and JP2 allow you to connect or disconnect the termination resistors (120 ohm) on / from the serial port COM2, when the operation mode in the BIOS is set to RS422 or RS485.



When installing the board at one end of the network, JP1 and JP2 jumper caps must be installed to connect the 120 ohm termination resistors.

**In RS422 mode, both jumper caps (JP1 and JP2) must be installed to connect the 120 ohm line termination resistors.**

JP1:-Pin Row, DIP 2-pin	Setting	Function COM2 (RS422)
1  2	Pin 1-2 Short/Closed	RS422 with connected termination resistor
1  2	Pin 1-2 Open (Default)	RS422 without connected termination resistor

JP2:-Pin Row, DIP 2-pin	Setting	Function COM2 (RS485 or RS422)
1  2	Pin 1-2 Short/Closed	RS485 or RS422 with connected termination resistor
1  2	Pin 1-2 Open (Default)	RS485 without connected termination resistor



The serial port COM2 (RS232 default setting) can be configured in the BIOS setup RS422 or RS485. Refer to BIOS settings for COM2 configuration as RS422 and RS485.



### 9.1.2.2. JP5: Jumper for RTC Reset (Clear CMOS Content)

This jumper allows you to clear the data (such as system password, date, time, and system setup parameters) in CMOS.



In order to change a jumper setting, please turn off the computer and unplug the power source to the board. Otherwise, the board could be damaged.

***The board might not start with this jumper in “closed” position.***

JP5: Pin Row, DIP 2-pin	Setting	Function
	Pin 1-2 Open (Default)	Normal Operation
	Pin 1-2 Short/Closed	Clear CMOS Content





For clearing of content, please wait 10 sec.

### 9.1.2.3. JP6: Disable CMOS Backup Restore Function

This jumper prevents the use of CMOS backup (in the case that the CMOS data are invalid). Set jumper (JP6) prevents, that wrong settings of the backup are loading. The system boots using the “power on defaults” from onboard RAM.



In order to change a jumper setting, please turn off the computer and unplug the power source to the board. Otherwise, the board could be damaged.



JP6: Pin Row, DIP 2-pin	Setting	Function
	Pin 1-2 Open (Default)	CMOS Backup-Function is enabled
	Pin 1-2 Short/Closed	CMOS Backup-Function is disabled

### 9.1.2.4. JP8: Image Flash; BIOS Programming



Before update the BIOS you have to contact our technical Support Department. Otherwise, the board could be damaged.

### 9.1.2.5. JP10: Enable/Disable the HDACT# LED for the USB Flash Module

JP10:-Pin Row, DIP 2-pin	Setting	Function
	Pin 1-2 (Default) Short/Closed	On pin 10 of the J10 USB boxed header is available the HDACT# LED signal of the USB Flash Module (refer to subsection 9.1.3.12)
	Pin 1-2 Open	No signal on pin 10 of the J10 USB boxed header (refer to subsection 9.1.3.12)



Do not set this jumper, if you intend to connect to the J10 USB port another USB device than the USB Flash Module.

### 9.1.3. Connectors On-Board

#### 9.1.3.1. J31: +12V ATX Power Connector

The ATX connector is used to connect the +12V ATX power supply to the board in order to provide power to the CPU.

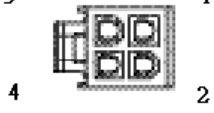
J31: 4-pin Connector	Pin	Signal Name
	1	GND
	2	GND
	3	+12V
	4	+12V

#### 9.1.3.2. J14: Multifunctional Connector

A system chassis can be equipped with components, that provide acoustical or/and light indication of the computer activities, and switches to change the computer status. J14 is a 16-pin box header that provides following connections:

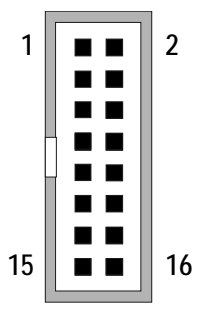
Signal Name	Pin #	J14: Boxed Header, DIP 16-pin	Pin #	Signal Name
KBCKL	1		2	GND
KBDATA	3		4	GND
VCC5V fused	5		6	PWRLED+
Speaker	7		8	VCC5V fused
MCKL	9		10	GND
MDATA	11		12	GND
PBRES#	13		14	GND
HDLED-	15		16	HDLED+

The multifunctional connector (J5) provides an interface:

- for a PS/2 keyboard and a PS/2 mouse connector
- to a speaker for audio tone generation
- to connect the Power LED
- to connect the hard drive activity LED
- to connect the reset button

#### Power LED: pins 4 and 6

These-pins allow the connection of the power LED.

#### Reset Button: pins 13 and 14

To these pins can be connected a reset button. The reset button is used to restart the system without turning the main power switch off and on again.



Depending on the software and operating system, some data may be lost if the reset button is activated.



**Hard Disk Drive LED: pins 15 and 16**

To these pins can be connected a hard drive activity LED. This LED will flash when the HDD is being accessed.

**Speaker: pins 7 and 8**

These-pins provide an interface to connect a speaker for audio tone generation. An 8-ohm speaker is recommended.

**Keyboard: pins 1, 2, 3, and 5**

These-pins can be used to connect the cable connection for an external PS/2 keyboard connector.

**Mouse: pins 9, 10, 11, and 5**

These-pins can be used to connect the cable connection for an external PS/2 mouse connector.

**9.1.3.3. J34: Additional Power Button Connector**

This connection allows you to attach an external ATX power button.

J34: 2-pin Row	Pin #	Signal Name
	1	GND

**9.1.3.4. J1: CPU Fan Power Connector**

It is a 4-pin header that allows the connection of the CPU fan. The CPU fan must be a 12V fan (max. 750 mA).

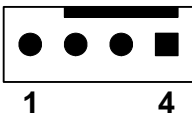
J1: 4-pin Molex Connector (friction lock)	Pin #	Signal Name
	1	CTRL (PWM)
	2	Rotation
	3	+12V
	4	GND

**9.1.3.5. J4: Chassis Fan1 Power Connector**

It is a 4-pin header that allows the connection of a chassis fan. The chassis fan must be a 12V fan (max. 750 mA).

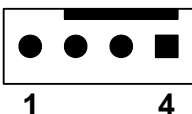
J4:- 4-pin Molex Connector (friction lock)	Pin #	Signal Name
	1	CTRL (PWM)
	2	Rotation
	3	+12V
	4	GND

**9.1.3.6. J24: Chassis Fan2 Power Connector**

It is a 4-pin header that allows the connection of a chassis fan. The chassis fan must be a 12V fan (max. 750 mA).

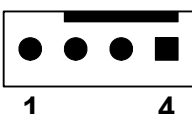
J24: 4-pin Molex Connector (friction lock)	Pin #	Signal Name
	1	CTRL (PWM)
	2	Rotation
	3	+12V
	4	GND



Also a 3-pin FAN connector cable can be can be connected to each of J1, J4 or J24.

**9.1.3.7. J5, J6, J11, and J12: Serial ATA Connectors**

These connectors allow you to connect Serial-ATA devices. (Each of the SATA interfaces supports one Serial-ATA device).

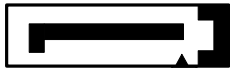

The PCI-760 board supports up to six Serial ATA ports. Two of the SATA ports (SATA4 and SATA5) are routed to the backplane via the PICMG 1.3 edge connector.

J5, J6, J11, and J12: Serial ATA: High Speed Headers Molex 67800-8001, Locking Latch)	Pin #	Signal Name
 <b>SATA</b>	1	GND
	2	TX+
	3	TX-
	4	GND
	5	RX-
	6	RX-
	7	GND

**9.1.3.8. J8: Parallel Port Connector (LPT)**

LPT is an IEEE1284 compatible interface and supports Normal/EPP/ECP mode.

This port is provided as a 26-pin boxed header.

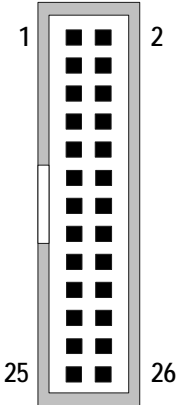
Signal Name	Pin #	J8: Boxed Header, DIP 26-pin	Pin #	Signal Name
Strobe#	1	 <b>LPT</b>	2	AutoFeed#
PD0, Data 0	3		4	Error#
PD1, Data 1	5		6	Initialize#
PD2, Data 2	7		8	SLIN
PD3, Data 3	9		10	GND
PD4, Data 4	11		12	GND
PD5, Data 5	13		14	GND
PD6, Data 6	15		16	GND
PD7, Data 7	17		18	GND
Acknowledge#	19		20	GND
Busy	21		22	GND
Paper empty	23		24	GND
SLCT	25		26	NC

### 9.1.3.9. J15: Serial Port Connector COM1

The 10-pin boxed header is to be used with the supplied serial cable.

#### COM1 pin assignment RS232:

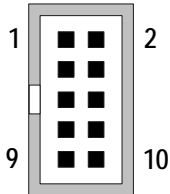
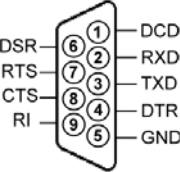
J15: Boxed Header, DIP 10-pin	RS232 (Pinning on the on-board header)		D-SUB Connector
 <p style="text-align: center;"><b>COM1</b></p>	<b>Pin #</b>	<b>Signal Name</b>	Pinning on the supplied cable connector:  
	1	DCD, Data carrier detect	
	2	DSR, Data set ready	
	3	RxD, Receive data	
	4	RTS, Request to send	
	5	TxD, Transmit data	
	6	CTS, Clear to send	
	7	DTR, Data terminal ready	
	8	RI, Ring indicator	
	9	GND, ground	
10	12 V, fused		

**9.1.3.10. J16: Serial Port Connector COM2**

The 10-pin box header is to be used with the supplied serial cable. This interface is RS232 (default) and can be configured as RS422 or RS485 (BIOS Setup).



For RS422 and RS485 mode, please install the jumper caps (JP1 and JP2) to use the onboard termination resistors (120ohm).



**RS232 mode (default)**

**RS422 point-to-point mode:**

The RX signal is always enabled via application software.

**RS485 party line mode:**

The RX signal is enabled when COM2 RTS is deasserted via application software.

The TX signal is enabled when COM2 RTS is asserted via application software.

**COM2-pin assignment as RS232 (default):**

J16: Boxed Header, DIP 10-pin	RS232 (Pinning on the on-board header)		D-SUB Connector
<p>COM2</p>	<b>Pin #</b>	<b>Signal Name</b>	Pining on the supplied cable connector:  
	1	DCD, Data carrier detect	
	2	DSR, Data set ready	
	3	RxD, Receive data	
	4	RTS, Request to send	
	5	TxD, Transmit data	
	6	CTS, Clear to send	
	7	DTR, Data terminal ready	
	8	RI, Ring indicator	
	9	GND, ground	
10	12 V, fused		

**COM2 pin assignment as RS422:**

J16: Boxed Header, DIP 10-pin	RS422 (Pinning on the on-board header)		D-SUB Connector
<p>COM2</p>	<b>Pin #</b>	<b>Signal Name</b>	Pining on the supplied cable connector:  
	1	NC	
	2	NC	
	3	RxD-, Receive data	
	4	RxD+, Receive data	
	5	TxD-, Transmit data	
	6	TxD+, Transmit data	
	7	NC	
	8	NC	
	9	GND, ground	
10	12 V fused		

## COM2 pin assignment as RS485:

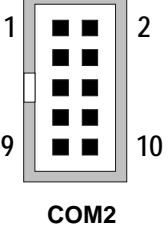
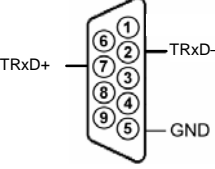
J16: Boxed Header, DIP 10-pin	RS485 (Pinning on the on-board header)		D-SUB Connector
	Pin #	Signal Name	
	1	NC	Pining on the supplied cable connector:  
	2	NC	
	3	TRxD-, Transmit/Receive data	
	4	TRxD+, Transmit/Receive data	
	5	12 V, fused	
	6	NC	
	7	NC	
	8	NC	
	9	GND, ground	
	10	12 V, fused	

## 9.1.3.11. J7: Hardware Monitor &amp; GPIO Connector

The hardware monitor & GPIO connector provides signals for hardware monitoring and allows you to monitor user defined function GPIO[0-3].

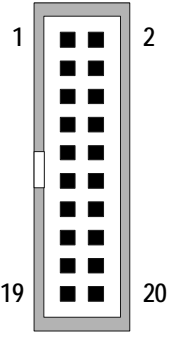
Signal Name	Pin#	J7: Box Header, DIP 20-pin	Pin#	Signal Name
GND	1		2	PWRBTN#
SMBALERT#	3		4	GND
EXT_SMBDATA	5		6	EXT_SMBCLK
APFLT# (GPIO[0]) (not supported)	7		8	CPUFLT# (GPIO[1]) (not supported)
* EXFLT# (GPIO[2]) (not supported)	9		10	GND
FANFLT# (GPIO[3]) (not supported)	11		12	GND
CHASINT#	13		14	GND
FAN_TACH1X(J4) (not supported)	15		16	FAN_TACH2X(J24) (not supported)
FAN_TACH3X (not supported)	17		18	SIO_TACH4 (not supported)
SIO_TACH5 (not supported)	19		20	SIO_TACH6 (not supported)



\* EXFLT# (GPIO[2])

Use this pin for alarm signal of a redundant PSU.

**9.1.3.12. J13, J19 and J10: USB Extension**

Each of the onboard boxed 10-pin-header for USB extension (J13, J19 and J10) supports two USB ports (Port 4 and Port 5 / Port 8 and Port 9 / Port 10 and Port 11). Pin 9 is removed for keying purposes. (A slot bracket with 2x USB type A connectors can be ordered separately.)



The PCI-760 board supports twelve USB ports (USB0-USB11).

- J29 (USB7) and J30 (USB6) are available on the slot bracket.
  - J13 (USB4 and USB5), J19 (USB8 and USB9) and
  - J10 (USB10 and USB11) are on board
- (J10 is used for the connection of the optional USB Flash Module; refer to the subsection 9.1.2.5 “JP10: Enable/Disable the HDACT# LED for the USB Flash Module”)*
- USB0, USB1, USB2 and USB3 are routed to the backplane via the PICMG 1.3 edge connector.

USB Port 5		J13: Boxed Header DIP 10-pin	USB Port 4	
Pin #	Signal Name		Pin #	Signal Name
1	VCC fused		2	VCC fused
3	D5-		4	D4-
5	D5+		6	D4+
7	GND		8	GND
9	Key		10	NC

USB Port 9		J19: Boxed Header DIP 10-pin	USB Port 8	
Pin #	Signal Name		Pin #	Signal Name
1	VCC fused		2	VCC fused
3	D9-		4	D8-
5	D9+		6	D8+
7	GND		8	GND
9	Key		10	NC

USB Port 11		J10: Boxed Header DIP 10-pin	USB Port 10	
Pin #	Signal Name		Pin #	Signal Name
1	VCC fused		2	VCC fused
3	D11-		4	D10-
5	D11+		6	D10+
7	GND		8	GND
9	Key		10	Refer to the subsection 9.1.2.5 „JP10: Enable/Disable the HDACT# LED for the USB Flash Module“

### 9.1.3.13. J21: Keyboard & Mouse for External Connector

This connector provides an interface for additional PS/2 keyboard and PS/2 mouse.

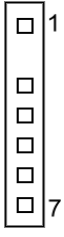
J21: Pin Row; DIP 7-pin	Pin #	Signal Name
 KBMS	1	KB DAT
	2	Key
	3	MS DAT
	4	GND
	5	VCC fused
	6	KB CLK
	7	MS CLK

### 9.1.3.14. J32: PS/2 Keyboard-Lock Connector

The keyboard lock allows the user to lock the PS/2 keyboard (if the chassis is equipped with a keyboard lock), protecting the system from unauthorized use.

J32: Pin-Row: 2-pin	Pin #	Signal Name
	1	GND
	2	KB Lock

### 9.1.3.15. J22: SPDIF-In & -Out

The SPDIF connector (J21) allows digital audio input and output via an adapter cable with slot mounting bracket for coaxial and/or optical fiber connection (not included).

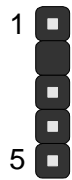
J22: Pin-Row: 5-pin	Pin #	Signal Name
	1	+5V
	2	Key
	3	SPDIF-out
	4	GND
	5	SPDIF-in

### 9.1.3.16. J35: External Battery Connector (option)

The PCI-760 is delivered with an on-board CMOS Lithium battery.

Depending on the configuration of your system, the CMOS Lithium battery can be connected to the J35 connector in order to have external accessibility.

J35: 2-pin Molex 22-23-2021 (friction lock)	Pin#	Signal Name
	1	V_BAT
	2	GND

**9.1.3.17. J33: Suspend LED**

J33 is available for connecting an LED, which indicates whether the system is in suspend mode or powered-up. The LED will be on when the system is in the suspend mode. If the system is fully powered up the LED will be dark.

J33: Pin-Row: 2-pin	Pin #	Signal Name
	1	GND
	2	SUSLED

**9.1.3.18. J20 and J23: Audio Connectors**

This is an interface for the I/O bracket audio cable that allows connection of audio devices (J20 for: Line-In, Line-Out, Mic-In) and (J23 for: Surround).

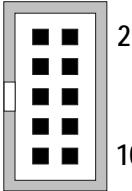
Signal Name	Pin #	J20: 10-pin Header	Pin #	Signal Name
LINEOUT_R	1		2	LINEOUT_L
AUDIO_GND	3		4	AUDIO_GND
LINEIN_L	5		6	LINEIN_R
AUDIO_GND	7		8	AUDIO_GND
MIC_IN_R	9		10	MIC_IN_R

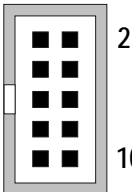
Signal Name	Pin #	J23: 10-pin Header	Pin #	Signal Name
SURR_OUT_R	1		2	SURR_OUT_L
AUDIO_GND	3		4	AUDIO_GND
SIDESURR_L	5		6	SIDESURR_R
AUDIO_GND	7		8	AUDIO_GND
LFE_OUT	9		10	CEN_OUT

**9.1.3.19. J41: Connector for Temperature Sensor**

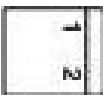
J41: Pin-Row: 2-pin	Pin #	Signal Name
	1	THRM_D+
	2	THRM_D-



The PCI-760 board comes factory-fitted with a temperature sensor [to the connector (J41)]. This temperature sensor measures the inside ambient temperature of the computer.



## 9.1.3.20. J28: MiniPCI Connector

MiniPCI Slot, 124-pin, Pin Assignments					
Pin	Signal	Pin	Signal	Pin	Signal
1	NC	51	AD21	101	GND
2	NC	52	AD22	102	GND
3	NC	53	AD19	103	AC97_SYNC
4	NC	54	AD20	104	GND (M66EN)
5	NC	55	GND	105	AC97_SDATAIN
6	NC	56	PAR	106	AC97_SDATAOUT
7	NC	57	AD17	107	AC97_BITCLK
8	NC	58	AD18	108	GND (ACCID0)
9	NC	59	-CEB2	109	PU (ACCID1)
10	NC	60	AD16	110	AC97_RESET
11	NC	61	-IRDY	111	MPCI_AUDMON
12	NC	62	GND	112	NC
13	NC	63	VCC3	113	GND
14	NC	64	-FRAME	114	GND
15	GND	65	-CLKRUN	115	MPCI_AUDOUT
16	NC	66	-TRDY	116	MPCI_AUDIN
17	-INTB	67	-SERR	117	GND
18	VCC	68	-STOP	118	GND
19	VCC3	69	GND	119	GND
20	-INTA	70	VCC3	120	GND
21	NC	71	-PERR	121	NC
22	NC	72	-DEVSEL	122	-MPCIACT
23	GND	73	-CBE1	123	VCC
24	V3.3Aux	74	GND	124	3.3VAUX
25	CLK	75	AD14		
26	-RST	76	AD15		
27	GND	77	GND		
28	VCC3	78	AD13		
29	-REQ	79	AD12		
30	-GNT	80	AD11		
31	VCC3	81	AD10		
32	GND	82	GND		
33	AD31	83	GND		
34	-PME	84	AD9		
35	AD29	85	AD8		
36	NC	86	-CBE0		
37	GND	87	AD7		
38	AD30	88	VCC3		
39	AD27	89	VCC3		
40	VCC3	90	AD6		
41	AD25	91	AD5		
42	AD28	92	AD4		
43	RESV	93	NC		
44	AD26	94	AD2		
45	-CBE3	95	AD3		
46	AD24	96	AD0		
47	AD23	97	VCC		
48	IDSEL	98	NC		
49	GND	99	AD1		
50	GND	100	NC		

### 9.1.4. PICMG 1.3 Connector (Edge Connector) PCI Express and PCI(-X) Interfaces

The “Side A” pins are on component side, the “Side B” pins are on solder side.

#### 9.1.4.1. SHB Express™ Connector Pinout

x16 PCIe Connector A			x8 PCIe Connector B		
	Side B	Side A		Side B	Side A
1	SMCLK	SMDAT	1	+5Vaux	+5Vaux
2	GND	GND	2	GND	RSVD NC*
3	TDI	TCK	3	a_PETp8	GND
4	TDO	TMS	4	a_PETn8	GND
5	TRST#	WAKE#	5	GND	a_PERp8
6	PWRBT#	PME#	6	GND	a_PERn8
7	PWRGD	PSON#	7	a_PETp9	GND
8	SHB_RST#	PERST#	8	a_PETn9	GND
9	CFG0	CFG1	9	GND	a_PERp9
10	CFG2	CFG3	10	GND	a_PERn9
11	RSVD NC*	GND	11	RSVD NC*	GND
	Mechanical Key			Mechanical Key	
12	GND	RSVD NC*	12	GND	RSVD NC*
13	b_PETp0	GND	13	a_PETp10	GND
14	b_PETn0	GND	14	a_PETn10	GND
15	GND	b_PERp0	15	GND	b_PERp10
16	GND	b_PERn0	16	GND	b_PERn10
17	b_PETp1	GND	17	a_PETp11	GND
18	b_PETn1	GND	18	a_PETn11	GND
19	GND	b_PERp1	19	GND	b_PERp11
20	GND	b_PERn1	20	GND	b_PERn11
21	b_PETp2	GND	21	a_PETp12	GND
22	b_PETn2	GND	22	a_PETn12	GND
23	GND	b_PERp2	23	GND	b_PERp12
24	GND	b_PERn2	24	GND	b_PERn12
25	b_PETp3	GND	25	a_PETp13	GND
26	b_PETn3	GND	26	b_PETn13	GND
27	GND	b_PERp3	27	GND	b_PERp13
28	GND	b_PERn3	28	GND	b_PERn13
29	REFCLK0+	GND	29	b_PETp14	GND
30	REFCLK0-	GND	30	b_PETn14	GND
31	GND	REFCLK1+	31	GND	b_PERp14
32	RSVD_G NC*	REFCLK1-	32	GND	b_PERn14
33	REFCLK2+	GND	33	b_PETp15	GND
34	REFCLK2-	GND	34	b_PETn15	GND
35	GND	REFCLK3+	35	GND	a_PERp15
36	RSVD-G NC*	REFCLK3-	36	GND	a_PERn15
37	REFCLK4+	GND	37	RSVD NC*	GND
38	REFCLK4-	GND	38	RSVD NC*	RSVD NC*
39	GND	REFCLK5+	39	GND	GND
40	RSVD-G NC*	REFCLK5-	40	GND	GND
41	REFCLK6+	GND	41	GND	GND
42	REFCLK6-	GND	42	GND	GND
43	GND	REFCLK7+	43	GND	GND
44	GND	REFCLK7-	44	+12V	+12V
45	a_PETp0	GND	45	+12V	+12V
46	a_PETn0	GND	46	+12V	+12V
47	GND	a_PERp0	47	+12V	+12V
48	GND	a_PERn0	48	+12V	+12V
49	a_PETp1	GND	49	+12V	+12V
50	a_PETn1	GND			
51	GND	a_PERp1			
52	GND	a_PERn1			
53	a_PETp2	GND			
54	a_PETn2	GND			
55	GND	a_PERp2			
56	GND	a_PERn2			

57	a_PETp3	GND
58	a_PETn3	GND
59	GND	a_PERp3
60	GND	a_PERn3
61	a_PETp4	GND
62	a_PETn4	GND
63	GND	a_PERp4
64	GND	a_PERn4
65	a_PETp5	GND
66	a_PETn5	GND
67	GND	a_PERp5
68	GND	a_PERn5
69	a_PETp6	GND
70	a_PETn6	GND
71	GND	a_PERp6
72	GND	a_PERn6
73	a_PETp7	GND
74	a_PETn7	GND
75	GND	a_PERp7
76	GND	a_PERn7
77	RSVD NC*	GND
78	+3.3V	+3.3V
79	+3.3V	+3.3V
80	+3.3V	+3.3V
81	+3.3V	+3.3V
82	+3.3Vaux NC*	+3.3Vaux NC*

x16 PCIe Connector C			x8 PCIe Connector D		
	Side B	Side A		Side B	Side A
1	USB0P	GND	1	INTB#	INTA#
2	USB0N	GND	2	INTD#	INTC#
3	GND	USB1P	3	GND	VIO
4	GND	USB1N	4	REQ3#	GNT3#
5	USB2P	GND	5	REQ2#	GNT2#
6	USB2N	GND	6	PCL_RST#	GNT1#
7	GND	USB3P	7	REQ1#	GNT0#
8	GND	USB3n	8	REQ0#	SERR#
9	USBOC0#	GND	9	SDONE NC*	+3.3v
10	GND	USBOC1#	10	GND	CLKFI
11	USBOC2#	GND	11	CLKFO	GND
	Mechanical Key			Mechanical Key	
12	GND	USBOC3#	12	CLKC	CLKD
13	SATHATOP	GND	13	GND	+3.3V
14	SATAH0N	GND	14	CLKA	CLKB
15	GND	SATAHR0P	15	+3.3V	GND
16	GND	SATAHR0N	16	AD31	GND
17	SATAHT1P	GND	17	AD29	+3.3V
18	SATAHT1N	GND	18	M66EN	AD30
19	GND	SATAHR1P	19	AD27	AD28
20	GND	SATAHR1N	20	AD25	GND
21	a_MDI0p	GND	21	GND	AD26
22	a_MDI0n	GND	22	C/BE3#	AD24
23	GND	a_MDI1p	23	AD23	+3.3V
24	GND	a_MDI1n	24	GND	AD22
25	a_MDI2p	GND	25	AD21	AD20
26	a_MDI2n	GND	26	AD19	PCIXCAP
27	GND	a_MDI3p	27	+5V	AD18
28	GND	a_MDI3n	28	AD17	AD16
29	IPMB_CL	GND	29	C/BE2#	GND
30	IPMB_DA	GND	30	PCL_PRST#	FRAME#
31	GA0 NC*	GA1 NC*	31	IRDY#	TRDY#
32	GA2 NC*	GA4 NC*	32	DEVSEL#	+5V
33	GA3 NC*	GA5 NC*	33	LOCK#	STOP#
34	b_MDI0p NC*	GND	34	PERR#	GND
35	b_MDI0n NC*	GND	35	GND	C/BE1#
36	GND	b_MDI1p NC*	36	PAR	AD14
37	GND	b_MDI1n NC*	37	SB0# NC*	GND
38	b_MDI2p NC*	GND	38	GND	AD12
39	b_MDI2n NC*	GND	39	AD15	AD10
40	GND	b_MDI3p NC*	40	AD13	GND
41	GND	b_MDI3n NC*	41	GND	AD09
42	+3.3V	+3.3V	42	AD11	C/BE0#
43	+3.3V	+3.3V	43	AD08	GND
44	+3.3V	+3.3V	44	GND	AD06
45	+3.3V	+3.3V	45	AD07	AD05
46	+3.3V	+3.3V	46	AD04	GND
47	+3.3V	+3.3V	47	GND	AD02
48	+3.3V	+3.3V	48	AD03	AD01
49	+3.3V	+3.3V	49	AD00	GND
50	+3.3V	+3.3V			
51	GND	GND			
52	GND	GND			
53	GND	GND			
54	GND	GND			
55	GND	GND			
56	GND	GND			
57	GND	GND			
58	GND	GND			
59	+5V	+5V			
60	+5V	+5V			
61	+5V	+5V			
62	+5V	+5V			

---

63	GND	GND
64	GND	GND
65	GND	GND
66	GND	GND
67	GND	GND
68	GND	GND
69	GND	GND
70	GND	GND
71	GND	GND
72	GND	GND
73	+12V	+12V
74	+12V	+12V
75	+12V	+12V
76	+12V	+12V
77	+12V	+12V
78	+12V	+12V
79	+12V	+12V
80	+12V	+12V
81	+12V	+12V
82	+12V	+12V

NC\*: Not connected

### 9.1.5. Lithium Battery

PCI-760 is provided with a 3.0 V “coin cell” lithium battery for the RTC operation and CMOS Setup RAM. Please observe the chapter 3.1 “Safety Instructions for the Lithium Battery”.

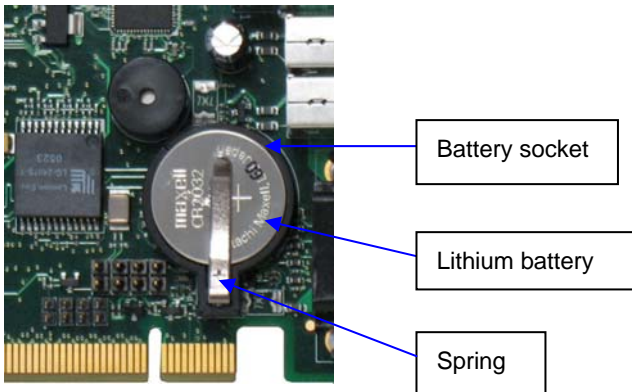

Fig. 6: Placement of the battery

#### 9.1.5.1. Replacing the Lithium Battery

To replace the battery please proceed as follows:

1. Turn the power off.
2. If your system is equipped with expansion cards, remove them first, if necessary.
3. Remove the battery by pressing outwards the ejector spring.
4. Insert the new battery into the socket.
5. Make sure that you insert the battery correctly. The minus pole must be as marked (with a white line on the battery) in the *fig. 5!*

The lithium battery must be replaced with an identical battery or a battery type recommended by Kontron Embedded Computers (Lithium battery 3.0 V for RTC, type: CR2032).



Do not dispose of lithium batteries in domestic waste. Dispose of the battery according to the local regulations dealing with the disposal of these special materials (e.g. to the collecting points for the disposal of batteries).

## 10. AMI BIOS Configuration

This chapter describes the settings available in the optional AMI BIOS for the PCI-760 board. The AMI BIOS (Basic Input/Output System) pre-installed in your computer system's ROM supports Intel® Pentium® M processor in a standard IBM AT compatible I/O system.

### 10.1. BIOS Setup

The AMI BIOS provides a Setup utility program for specifying the system configurations and settings. The BIOS ROM of the system stores the Setup utility. When you turn on the computer, the AMI BIOS is activated.

Pressing the <Del> key immediately allows you to enter the Setup utility. If you are a little bit late pressing the <Del> key, POST (Power On Self Test) will continue with its test routines, thus preventing you from invoking the Setup. If you still wish to enter Setup, restart the system by pressing the "Reset" button or simultaneously pressing the <Ctrl>, <Alt> and <Delete> keys. You can also restart by turning the system Off and back On again. The following message will appear on the screen:

```
Press <DEL> to Enter Setup
```

In general, you press the arrow keys to highlight items, <Enter> to select, the <PgUp> and <PgDn> keys to change entries, <F1> for help and <Esc> to quit.

When you enter the Setup utility, the Main Menu screen will appear on the screen. The Main Menu allows you to select from various Setup functions and exit choices.

The BIOS Setup screen has two main frames. The left frame displays all the options that can be configured. "Grayed-out" options cannot be configured. Blue options can be select and configured.

The right frame displays the key legend. Above the key legend is an area reserved for a text message. When an option is selected in the left frame, it is highlighted in white. Often a text message will accompany it.

#### 10.1.1. Navigation

Hot Key	Description
→← Left/Right	The <i>Left and Right</i> <Arrow> keys allow you to select a BIOS Setup screen.  For example: Main screen, Advanced screen, Chipset screen, and so on.
↑↓ Up/Down	The <i>Up and Down</i> <Arrow> keys allow you to select a BIOS Setup item or sub-screen.
+ / - Plus/Minus	The <i>Plus and Minus</i> <Keys> keys allow you to change the field value of a particular BIOS Setup item.  For example: Date and Time.
Tab	The <Tab> key allows you to select BIOS Setup fields.



The <F8> key on your keyboard is the Fail-Safe key. It is not displayed on the key legend by default. To set the Fail-Safe settings of the BIOS, press the <F8> key on your keyboard. The Fail-Safe settings allow the motherboard to boot up with the least amount of options enabled. This can lessen the probability of conflicting settings.

The <F9> key on your keyboard is the Optimal-Default key. To set the Optimal-Default settings of the BIOS, press the <F9> key on your keyboard.

## 10.2. Main

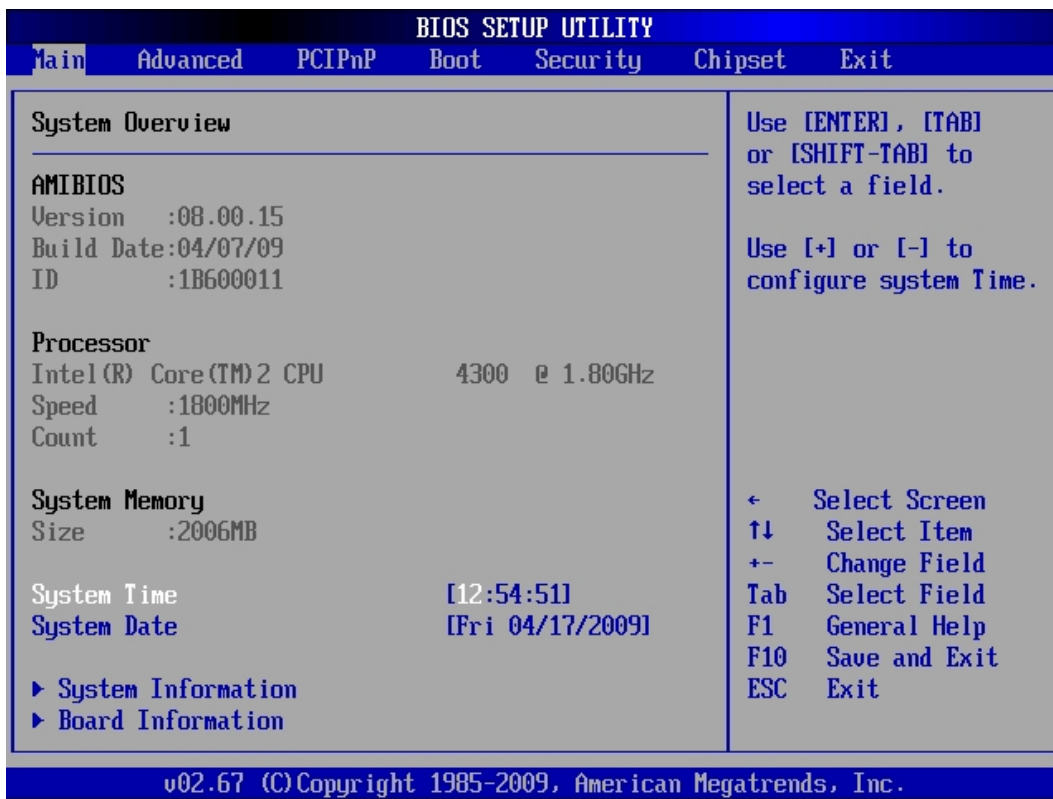

### 10.2.1. System Time / System Date

<i>System Time</i>	<p>This field indicates the time of the device. If you change the time setting, enter the time in the format <i>HH:MM:SS</i></p> <p>HH=Hours MM=Minutes SS=Seconds</p>
<i>System Date</i>	<p>This field indicates the date of the device. If you change the date setting, enter the date in the format <i>MM.DD.YYYY</i>.</p> <p>MM=Month DD=Day YYYY=Year</p> <p>The "System Date" format can be arbitrary configured.</p>



➤ **Board Information**

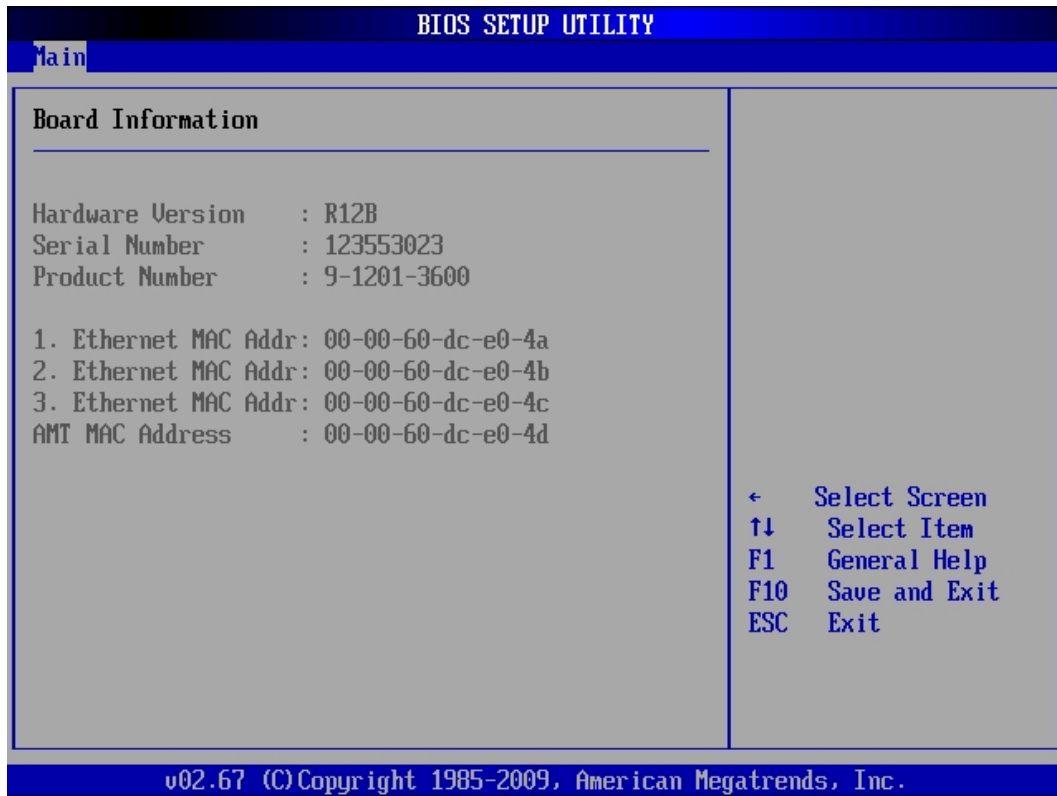

➤ **System Information**

The system information is available only when a customized ordered tool is installed.

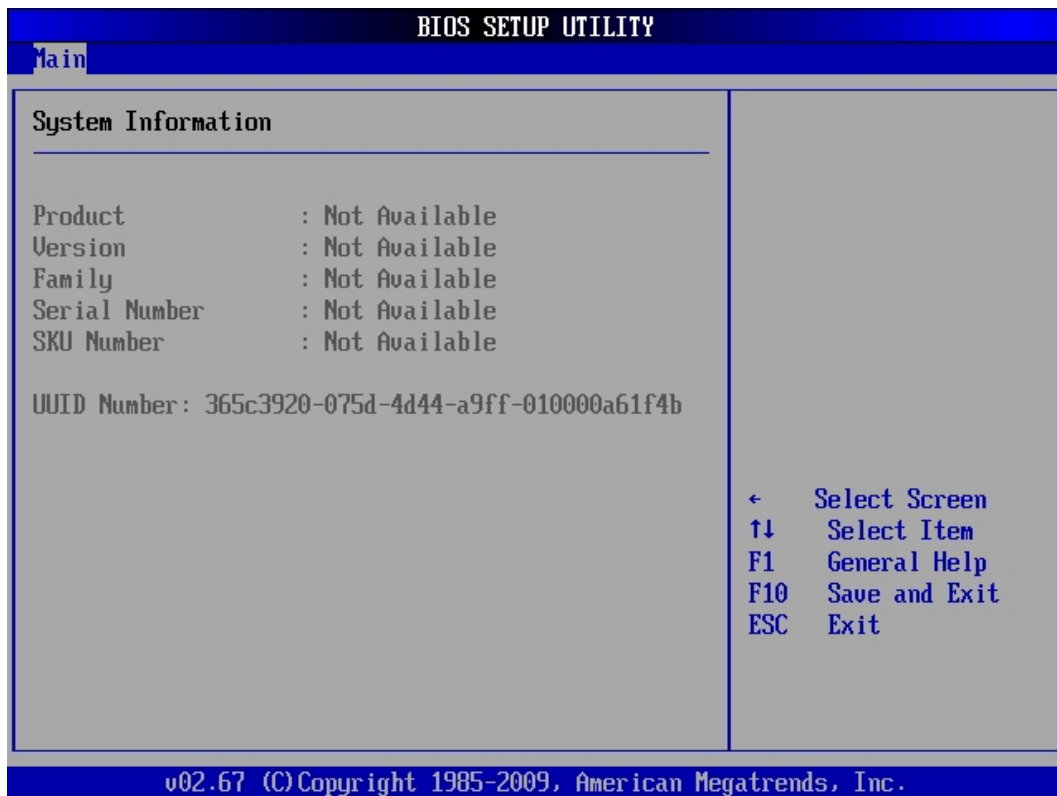

### 10.3. Advanced

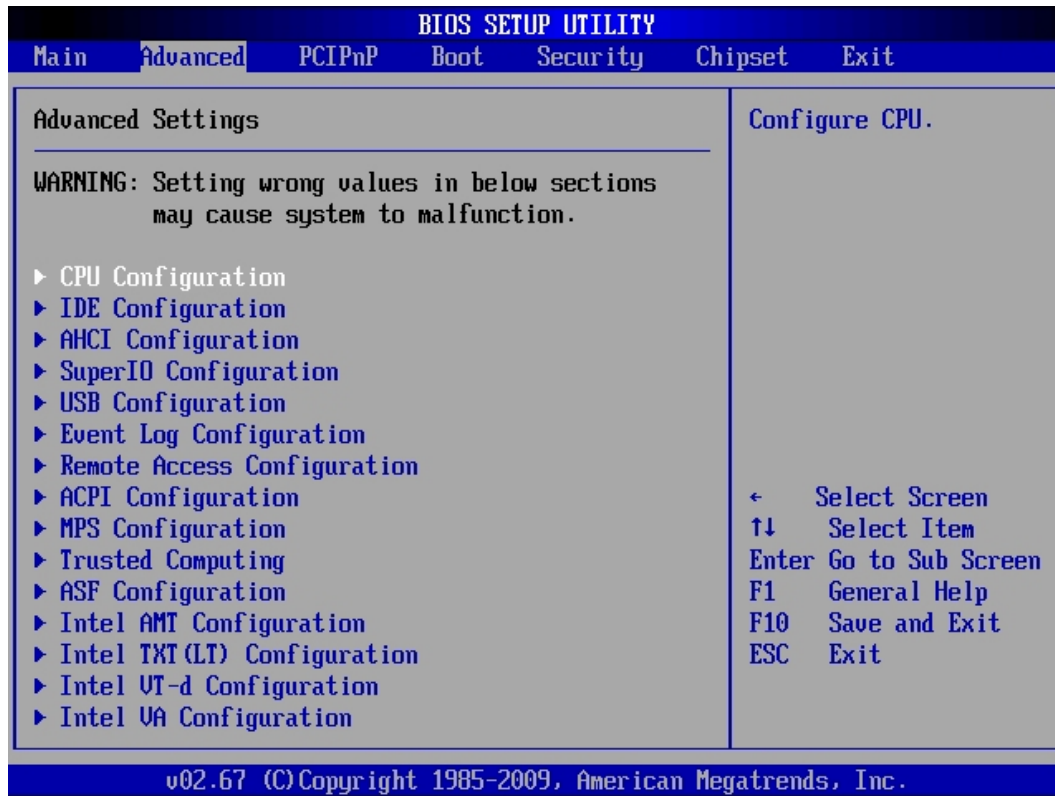

You can select the sub menus of the *Advanced* BIOS Setup:

- |                               |                                |
|-------------------------------|--------------------------------|
| • CPU Configuration           | • MPS Configuration            |
| • IDE Configuration           | • Trusted Computing            |
| • AHCI Configuration          | • ASF Configuration            |
| • SuperIO Configuration       | • Intel AMT Configuration      |
| • USB Configuration           | • Intel TXT (LT) Configuration |
| • Event Log Configuration     | • Intel VT-d Configuration     |
| • Remote Access Configuration | • Intel VA Configuration       |
| • ACPI Configuration          |                                |

### 10.3.1. CPU Configuration (Configure advanced CPU settings)

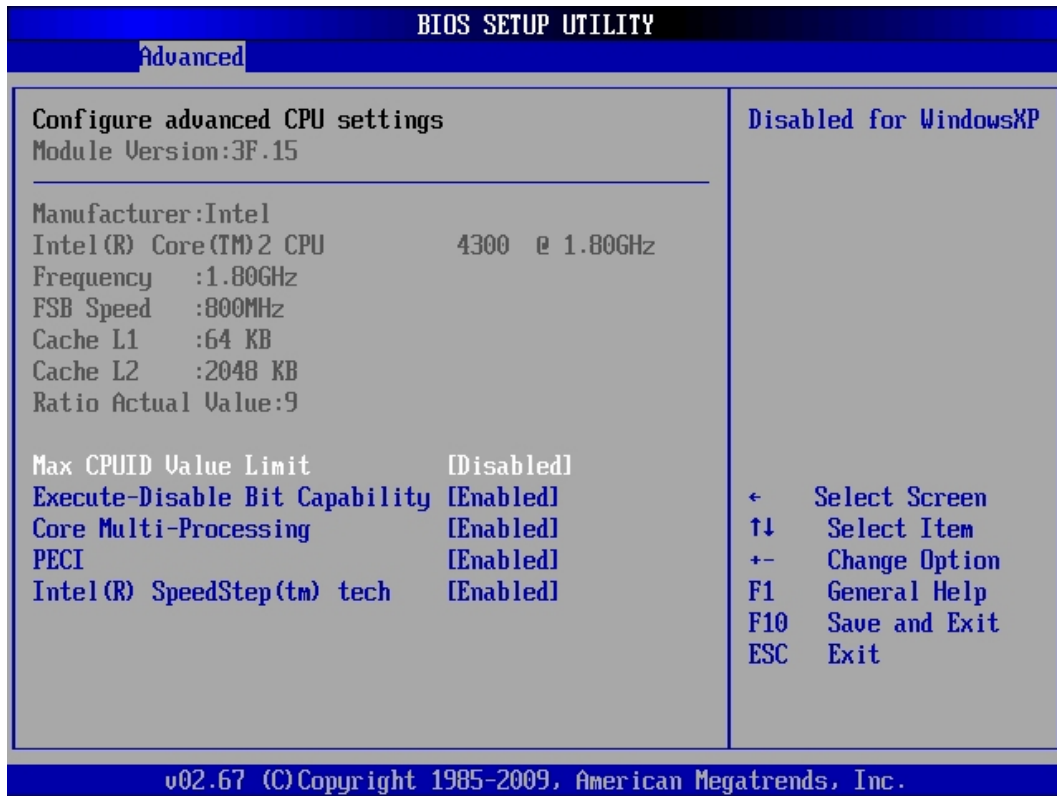

#### 10.3.1.1. Max CPUID Value Limit

Disabled for Windows XP

Available settings are: **Disabled** and *Enabled*.

#### 10.3.1.2. Execute Disable Bit Capability

When “*Disabled*” is set, forces the Execute-Disable Bit Capability extended feature bit to always return 0.

Available settings are: **Enabled** and *Disabled*.

#### 10.3.1.3. Core Multi-Processing

When “*Disabled*” is set, disables one execution core of each CPU die.

Available settings are: **Enabled** and *Disabled*.

#### 10.3.1.4. Peci

When “*Enabled*” is set, enables the Peci interface.

Available settings are: **Enabled** and *Disabled*.

#### 10.3.1.5. Intel® SpeedStep™ tech

If “*Disabled*” is set, disables GV3.

If “*Enabled*” is set, enables GV3

Available settings are: **Enabled** and *Disabled*.

### 10.3.2. IDE Configuration

This field can be used to select options for the IDE Configuration settings.

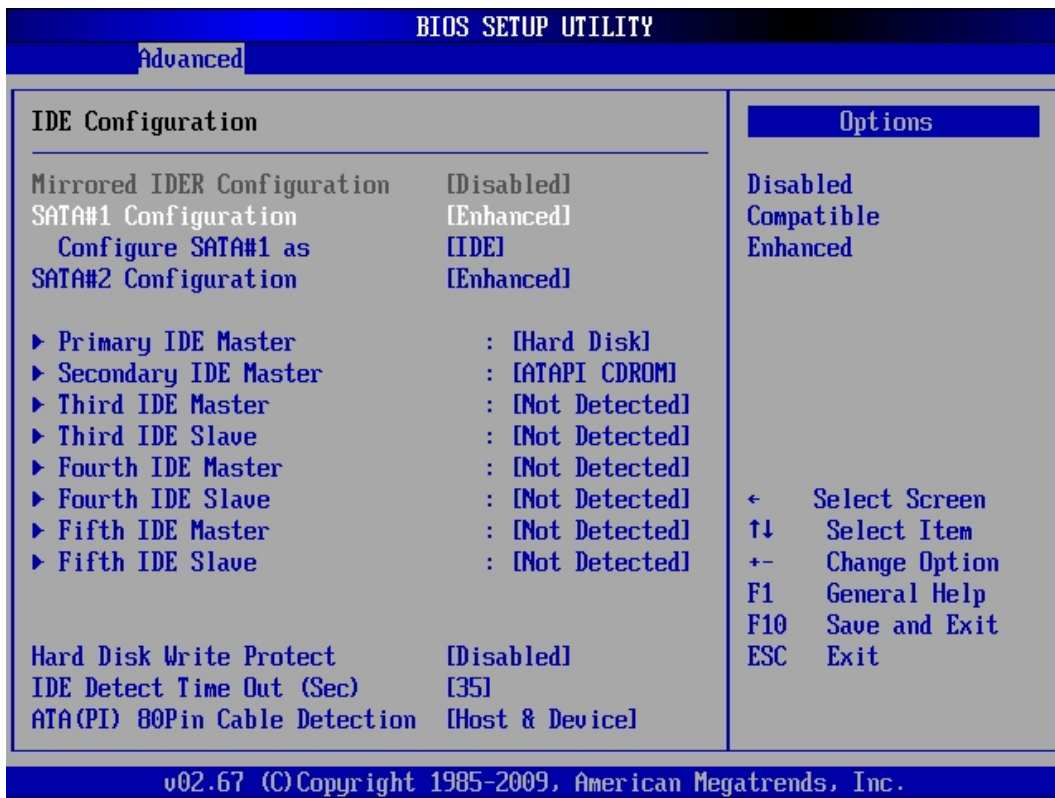

#### 10.3.2.1. SATA#1 Configuration (SATA#1 Controller)

Available settings are: **Enhanced**, *Compatible* and *Disabled*.

#### 10.3.2.2. Configure SATA#1 as

Available settings are: **IDE**, *RAID* and *AHCI*.

#### 10.3.2.3. SATA#2 Configuration (SATA#2 Controller)

Available settings are: **Enhanced** and *Disabled*.

#### 10.3.2.4. Hard Disk Write Protect

This option allows you to enable or disable the device write protection. This will be effective only if the device is accessed through BIOS.

Available settings: *Enabled* and **Disabled**.

### 10.3.2.5. IDE Detect Time Out (Sec)

Set this option to stop the AMI BIOS from searching for IDE devices within the specified number of seconds. Basically, this allows you to fine-tune the settings to allow for faster boot times.



Low settings can cause unreliable detection!

Possible settings are: 0, 5, 10, 15, 20, 25, 30 and **35**.

0	This is the optimal setting for systems whose onboard controllers point to a specific IDE device in the AMI BIOS.
5	Set this option to stop the BIOS from searching the IDE Bus for IDE devices in five seconds.
10	Set this option to stop the BIOS from searching the IDE Bus for IDE devices in ten seconds.
15	Set this option to stop the BIOS from searching the IDE Bus for IDE devices in 15 seconds.
20	Set this option to stop the BIOS from searching the IDE Bus for IDE devices in 20 seconds.
25	Set this option to stop the BIOS from searching the IDE Bus for IDE devices in 25 seconds.
30	Set this option to stop the BIOS from searching the IDE Bus for IDE devices in 30 seconds.
<b>35</b>	This setting is recommended for all IDE devices that are set to AUTO in the BIOS setting (because a Master waits 30 sec. max. for a slave device).

### 10.3.2.6. ATA(PI) 80Pin Cable Detection

Set this option to define the method used to detect an ATA (PI) 80-pin cable. Possible settings are: **Host & Device**, *Host* and *Device*.

<b>Host &amp; Device</b>	Set this value to use both the motherboard IDE controller and the IDE device to detect the type of IDE cable present.
<i>Host</i>	Set this value to use motherboard onboard IDE controller to detect the type of IDE cable present.
<i>Device</i>	Set this value to use IDE disk drive to detect the type of IDE cable present.

### ➤ Primary IDE Master / Primary IDE Slave

These fields call the submenu to make corresponding settings of the IDE devices.



You should change the default settings only if you are connecting an additional IDE drive (e.g. Hard disk drive).

The description of the setting options for *Primary IDE Master* also applies to *Primary IDE Slave*



**The default settings strongly depend on the installed drive.**

**These entries are specific for each installed device as:**

- Primary IDE Master/Primary IDE Slave
- Secondary IDE Master/Secondary IDE Slave
- Third IDE Master/Third IDE Slave
- Fourth IDE Master/Fourth IDE Slave

The screens below are only an example for which entries could be available.

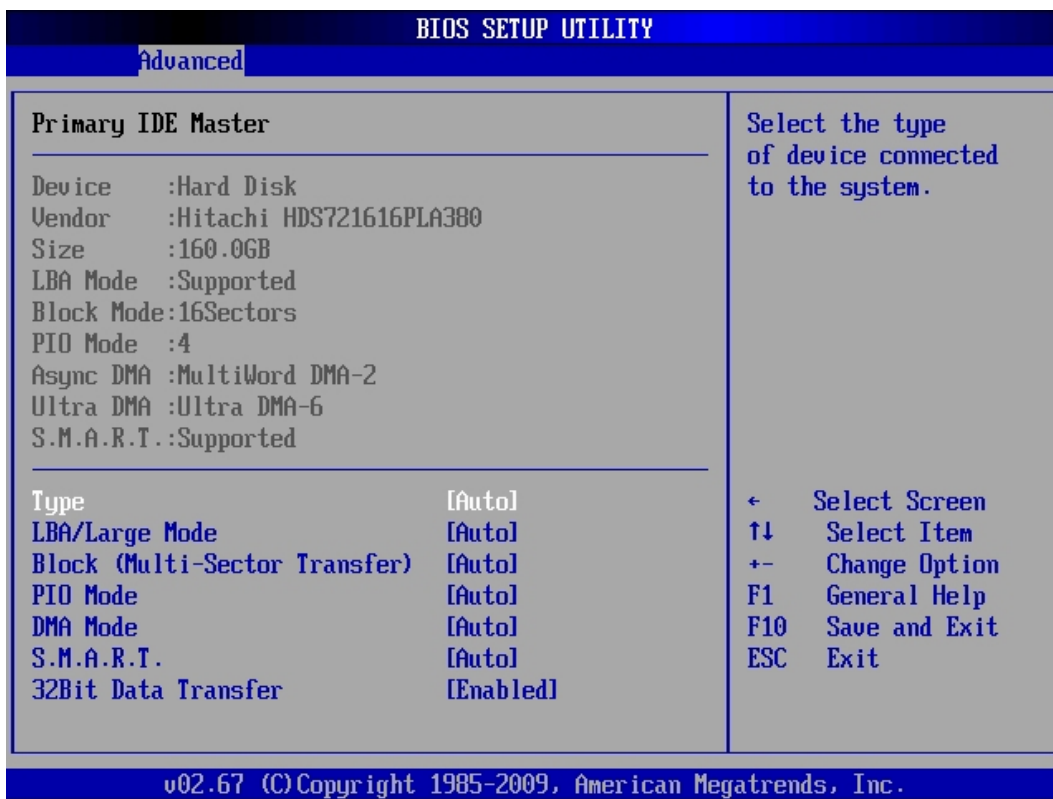

BIOS SETUP UTILITY	
Advanced	
<b>Secondary IDE Master</b>	
Device :ATAPI CDROM Vendor :ASUS DVD-E818AT LBA Mode :Supported PIO Mode :4 Async DMA :MultiWord DMA-2 Ultra DMA :Ultra DMA-5	
Type	[Auto]
PIO Mode	[Auto]
DMA Mode	[Auto]
Select the type of device connected to the system.	
← Select Screen ↑↓ Select Item +- Change Option F1 General Help F10 Save and Exit ESC Exit	
v02.67 (C) Copyright 1985-2009, American Megatrends, Inc.	

BIOS SETUP UTILITY	
Advanced	
<b>Third IDE Slave</b>	
Device :Not Detected	
LBA/Large Mode	[Auto]
Block (Multi-Sector Transfer)	[Auto]
PIO Mode	[Auto]
DMA Mode	[Auto]
S.M.A.R.T.	[Auto]
32Bit Data Transfer	[Enabled]
Disabled: Disables LBA Mode. Auto: Enables LBA Mode if the device supports it and the device is not already formatted with LBA Mode disabled.	
← Select Screen ↑↓ Select Item +- Change Option F1 General Help F10 Save and Exit ESC Exit	
v02.67 (C) Copyright 1985-2009, American Megatrends, Inc.	

**10.3.2.7. Type**

Select the type of device connected to the system.

*Not Installed, Auto, CD/DVD and ARMD (ATAPI Removable Media Device).*

**10.3.2.8. LBA/Large Mode**

The LBA (Logical Block Addressing)/Large Mode option allows you to enable or disable support for IDE devices with capacities greater than 528MB. The maximum drive capacity in the LBA mode is 137GB.

<b>Auto</b>	This setting allows the BIOS to auto-detect LBA mode control on the specified channel (if the device supports it and the device is not already formatted with LBA Mode disabled).
<b>Disabled</b>	Disables the LBA Mode and prevent the BIOS from using LBA mode control on the specified channel.

**10.3.2.9. Block (Multi-Sector Transfer)**

If your hard disk supports the block mode, select *Auto* for the automatic determination of the number of the blocks per request. Several sectors can be at the same time read/written. The data transfer rate will be increased.

Available settings are: **Auto** and *Disabled*.

<b>Auto</b>	The data transfer from and to the device occurs multiple sectors at a time if the device supports it. Block mode allows transfers of up to 64Kb per interrupt.
<b>Disabled</b>	The data transfer from and to the device occurs one sector at a time. Only 512 byte of data can be transferred per interrupt if block mode is not used. This setting should be used only if read and write failures occur with "Auto".

**10.3.2.10. PIO Mode**

These fields allow your system IDE controller to work faster. Rather than have the BIOS issue a series of commands that transfer to or from the IDE drive, PIO (Programmed Input/Output) allows the BIOS to communicate with the controller and CPU directly.

The system supports five modes, numbered from 0 to 4, which primarily differ in timing. Available settings are: *0, 1, 2, 3, 4* and *Auto*. When *Auto* is selected, the BIOS will select the best available mode.

Available settings are: **Auto**, *0, 1, 2, 3* and *4*.

<b>Auto</b>	This setting allows the BIOS to auto-detect the PIO mode. This setting is to be used if the IDE disk drive cannot be determined.
<i>0</i>	This setting allows the BIOS to use the PIO mode 0. It has a data transfer rate of 3.3MBs.
<i>1</i>	This setting allows the BIOS to use the PIO mode 1. It has a data transfer rate of 5.2MBs.
<i>2</i>	This setting allows the BIOS to use the PIO mode 2. It has a data transfer rate of 8.3MBs.
<i>3</i>	This setting allows the BIOS to use the PIO mode 3. It has a data transfer rate of 11.1MBs.
<i>4</i>	This setting allows the BIOS to use the PIO mode 4. It has a data transfer rate of 16.6MBs. This setting generally works with all hard disk drives manufactured after 1999. For other disk drive, such as IDE CD-ROM drives, check the specifications of the drive.



Do not change the default setting "**Auto**".

If some read and write failures occur, check the length and quality of the integrated device cable first or set this option to a setting with a lower data transfer rate as specified for your device.



### 10.3.2.11. DMA Mode

This option allows you to select the DMA mode option (depending on the integrated device). Available settings are: **Auto**, SWDMA0, SWDMA1, SWDMA2, MWDMA0, MWDMA1, MWDMA2, UDMA0, UDMA1, UDMA2, UDMA3, UDMA4, UDMA5 and UDMA6.

<b>Auto</b>	If "Auto" is set, the BIOS auto-detects the DMA mode. This is the default setting.
<b>SWDMA0</b>	If "SWDMA0" is set the BIOS uses the Single Word DMA mode 0. It has a data transfer rate of 2.1MBs.
<b>SWDMA1</b>	If "SWDMA1" is set the BIOS uses the Single Word DMA mode 1. It has a data transfer rate of 4.2MBs.
<b>SWDMA2</b>	If "SWDMA2" is set the BIOS uses the Single Word DMA mode 2. It has a data transfer rate of 8.3MBs.
<b>MWDMA0</b>	If "MWDMA0" is set the BIOS uses the Multi Word DMA mode 0. It has a data transfer rate of 4.2MBs.
<b>MWDMA1</b>	If "MWDMA1" is set the BIOS uses the Multi Word DMA mode 1. It has a data transfer rate of 13.3MBs.
<b>MWDMA2</b>	If "MWDMA2" is set the BIOS uses the Multi Word DMA mode 2. It has a data transfer rate of 16.6MBs.
<b>UDMA0</b>	If "UDMA0" is set the BIOS uses the Ultra DMA mode 0. It has a data transfer rate of 16.6MBs (the same data transfer rate as PIO mode 4, and Multi Word DMA mode 2).
<b>UDMA1</b>	If "UDMA1" is set the BIOS uses the Ultra DMA mode 1. It has a data transfer rate of 25MBs.
<b>UDMA2</b>	If "UDMA2" is set the BIOS uses the Ultra DMA mode 2. It has a data transfer rate of 33.3MBs.
<b>UDMA3</b>	If "UDMA3" is set the BIOS uses the Ultra DMA mode 3. It has a data transfer rate of 44.4MBs. It is required to be used the 80-conductor ATA cable for this data transfer rate.
<b>UDMA4</b>	If "UDMA4" is set the BIOS uses the Ultra DMA mode 4. It has a data transfer rate of 66.6MBs. It is required to be used the 80-conductor ATA cable for this data transfer rate.
<b>UDMA5</b>	If "UDMA5" is set the BIOS uses the Ultra DMA mode 5. It has a data transfer rate of 99.9MBs. It is required to be used the 80-conductor ATA cable for this data transfer rate.
<b>UDMA6</b>	If "UDMA6" is set the BIOS uses the Ultra DMA mode 6. It has a data transfer rate of 133.2MBs. It is required to be used an 80-conductor ATA cable for this data transfer rate.

### 10.3.2.12. S.M.A.R.T.

S. M. A. R. T. (Self-Monitoring, Analysis and Reporting Technology) is used to predict drive failures. (The integrated drive has to support this feature).

Available Settings are: **Auto**, *Disabled* and *Enabled*.

### 10.3.2.13. 32Bit Data Transfer

This option allows you to enable or disable the 32bit data transfer rate for the IDE devices. If this option is "Enabled" the data transfer is accelerated and the CPU (PCI Bus) is relieved.

Available settings are: **Enabled** and *Disabled*.

### 10.3.3. AHCI Configuration (AHCI Settings)

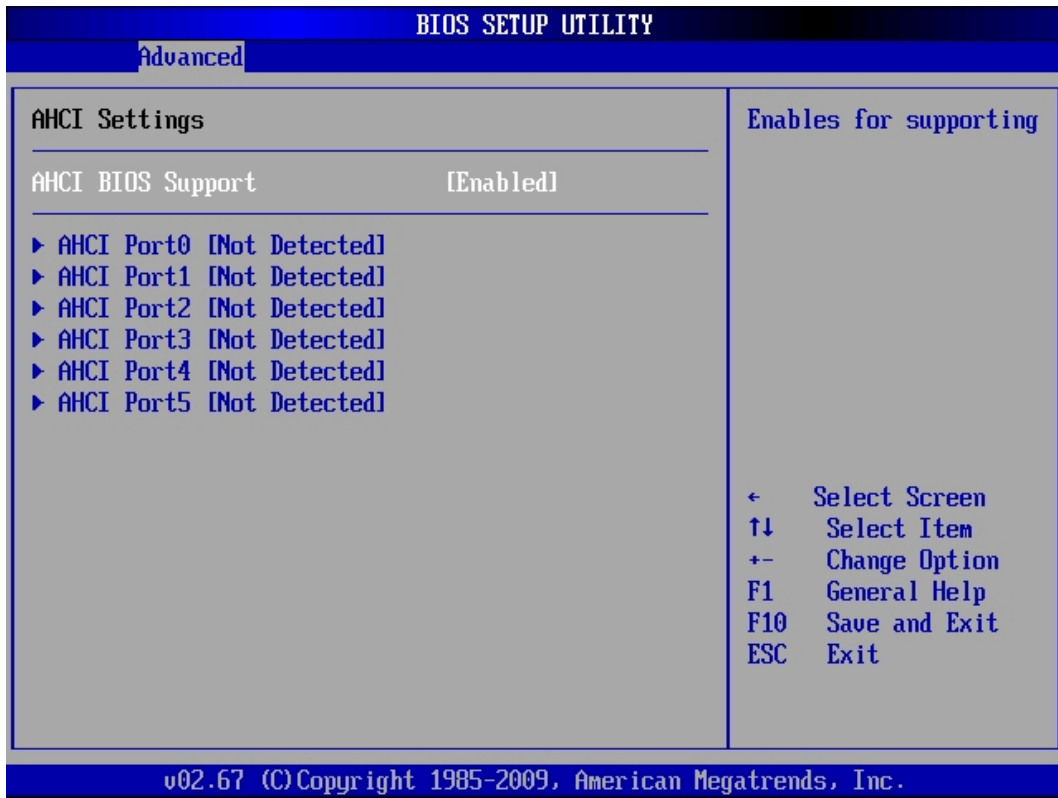

#### 10.3.3.1. AHCI BIOS Support

In order to support the AHCI (Advanced Host Controller Interface) (referring to IDE Configuration/ Configure SATA#1 as/AHCI setting) this option must be set to *Enabled*. For detailed information refer to “Serial ATA AHCI 1.2 Specification”.

Available settings: **Enabled** and *Disabled*.

#### 10.3.3.2. AHCI Port0/ /AHCI Port5

These options display the detected SATA devices (if configured in IDE Configuration/ Configure SATA#1 as to AHCI). Each SATA detected device (AHCI configured) allows following:

**SATA #(1/ /5)** with available settings: **Auto** and *Not Installed*.

**S.M.A.R.T.** with available settings: **Enabled** and *Disabled*.

### 10.3.4. Super IO Configuration (Configure Win627 Super IO Chipset)

This field can be used to select the Super I/O settings.

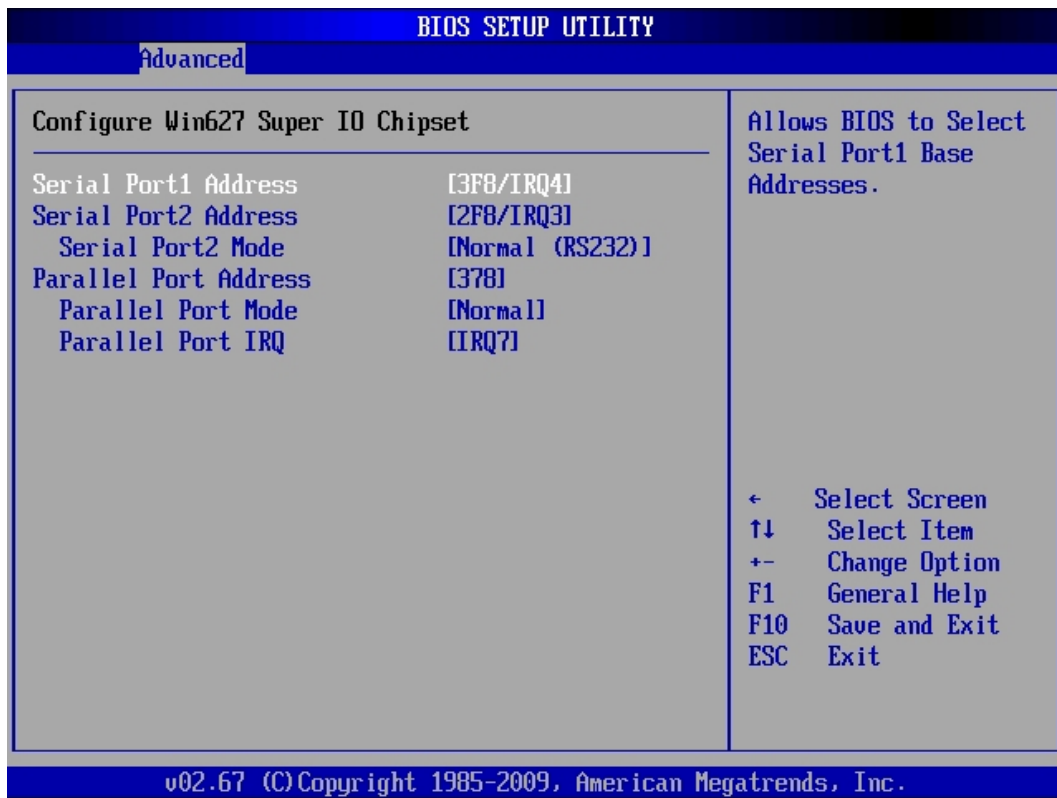

#### 10.3.4.1. Serial Port 1 & 2 Address

These fields allow you to select the onboard serial ports and their addresses.

Available settings are:

	Default	Available settings (without default setting)
Serial Port 1 Address	<b>3F8/IRQ4</b>	3E8/IRQ4 / 2E8/IRQ3 / Disabled
Serial Port 2 Address	<b>2F8/IRQ3</b>	3E8/IRQ4 / 2E8/IRQ3 / Disabled

**10.3.4.2. Serial Port2 Mode**

This field allows you to select the line mode for serial communication. Available settings are: **Normal (RS232)**, **RS422** and **RS485**.

If the [Serial Port2 Mode] is set to **RS422** is available a supplementary option: [Serial Port2 Transmitter].

<b>If Serial Port2 Mode is set to RS422</b>	<b>Available settings</b>
Serial Port2 Transmitter	Enabled and <b>Disabled</b>

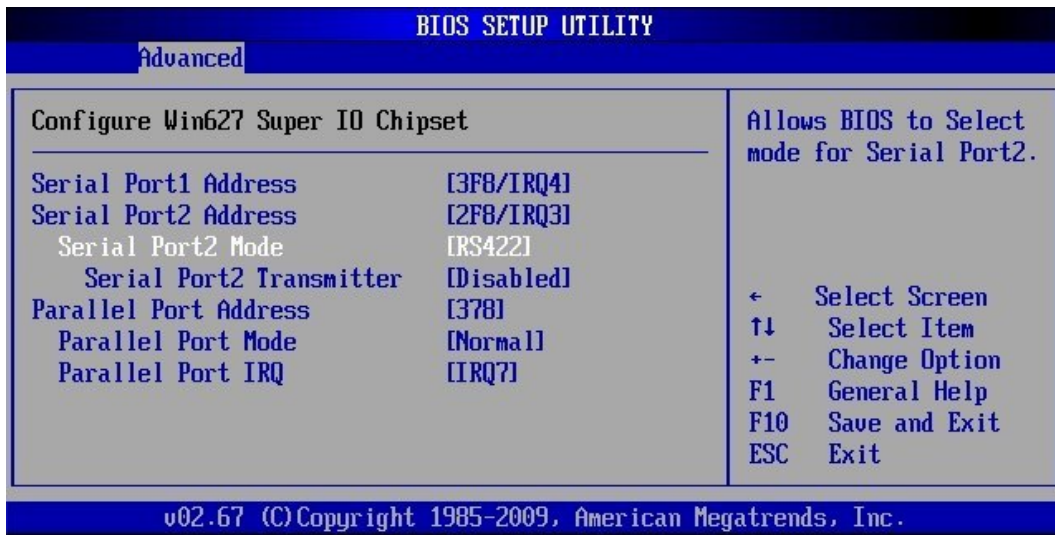

**10.3.4.3. Parallel Port Address**

This field selects the I/O address used to access the parallel interface.

The possible values are: **Disabled**, **378**, **278**, **3BC**.



The use of address space **3BC** may be restricted for some modes because it doesn't allow for eight consecutive addresses.

**10.3.4.4. Parallel Port Mode**

This field is used to specify whether the parallel port is to be used as a bi-directional input/output port or just as an output port. **ECP** and **EPP** transfer modes allow faster transfer rates of 2 and 2.4 Mbytes/s. These modes will only work with peripheral devices which support them. In addition, the field **Parallel Port Address** must be set to **378** or **278** when using one of these two modes.

<b>Normal</b>	The port functions as an output port only.
<b>Bi-Directional</b>	Data can be transferred in both directions across the port.
<b>EPP</b>	Fast transfer mode (up to 2 Mbytes/s), can output and receive data. The mode requires a peripheral device which supports the EPP (Enhanced Parallel Port) transfer mode.
<b>ECP</b>	Fast transfer mode (up to 2.4 Mbytes/s), can output and receive data. The mode requires a peripheral device which supports the ECP (Enhanced Capability Port) transfer mode.
<b>ECP &amp; EPP</b>	Fast transfer mode (up to 2.4 Mbytes/s), can output and receive data. The mode requires a peripheral device which supports both EPP (Enhanced Parallel Port) and ECP (Enhanced Capability Port) transfer mode.

**10.3.4.5. Parallel Port IRQ**

This field selects the interrupt used for the parallel interface.

It is possible to choose between: **IRQ7** and **IRQ5**.

<b>IRQ7</b>	This setting allows the parallel port to use the interrupt IRQ7.
<b>IRQ5</b>	This setting allows the parallel port to use the interrupt IRQ5.

### 10.3.5. USB Configuration

This field allows you to select options for USB configuration.

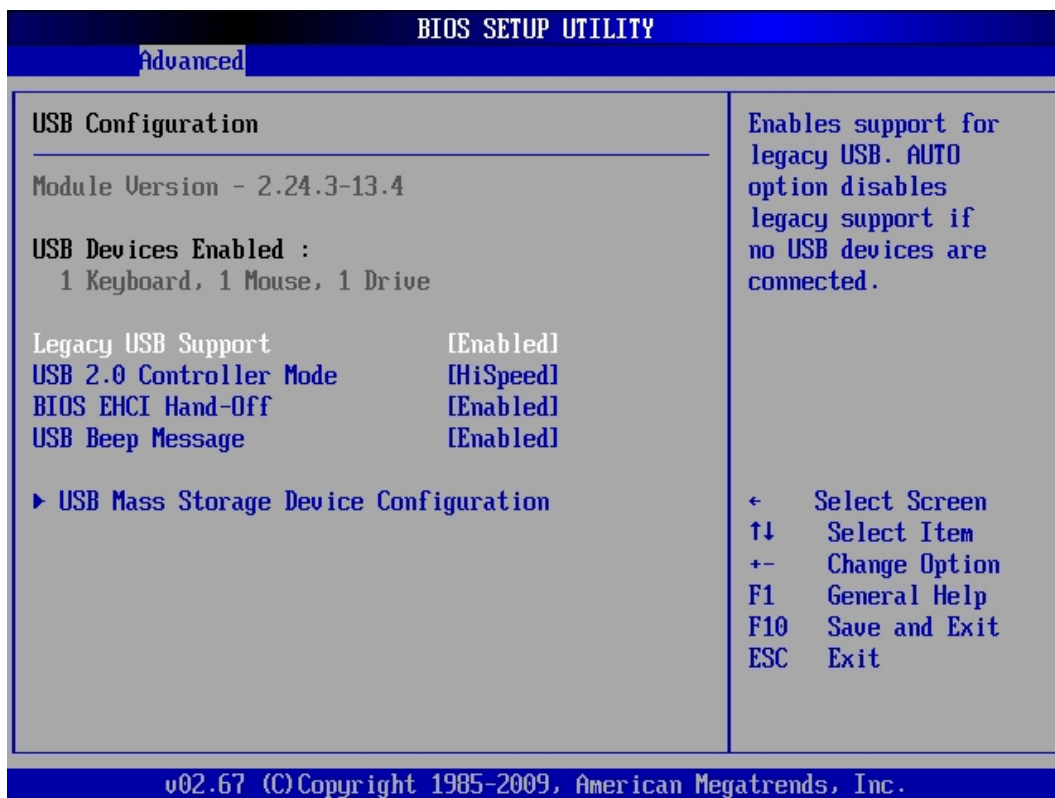

#### 10.3.5.1. Legacy USB Support

This function enables or disables support for legacy USB. Enabling legacy USB support allows using USB devices under DOS and other non-Plug & Play operating systems.

Possible settings are: **Enabled**, *Disabled* and *Auto*.

If “Auto” is set, the system searches for USB devices. Whether no device is detected, the BIOS disable this option in background.

#### 10.3.5.2. USB 2.0 Controller Mode

The [USB 2.0 Controller Mode] option is available only if the option [Legacy USB Support] is set to **Enabled** or **Auto**.

This option allows you to set the data signaling rate for the USB 2.0 controller.

Possible settings are: *FullSpeed* and **HiSpeed**.

<b>HiSpeed</b>	This setting allows data signaling rate of 480 Mbps.
<i>FullSpeed</i>	This setting allows data signaling rate of 12 Mbps.

#### 10.3.5.3. BIOS EHCI Hand-Off

The [BIOS EHCI Hand-Off] option is available only if the option [Legacy USB Support] is set to **Enabled** or **Auto**.

This option allows you to enable support for operating systems without “EHCI Hand-Off” features.

Possible settings are: **Enabled** and *Disabled*.

#### 10.3.5.4. USB Beep Message

This option allows you to enable or disable generating a beep during USB devices enumeration.

Possible settings are: **Enabled** and *Disabled*.

### ➤ USB Mass Storage Device Configuration

This option is only available if USB storage devices are connected to the board.

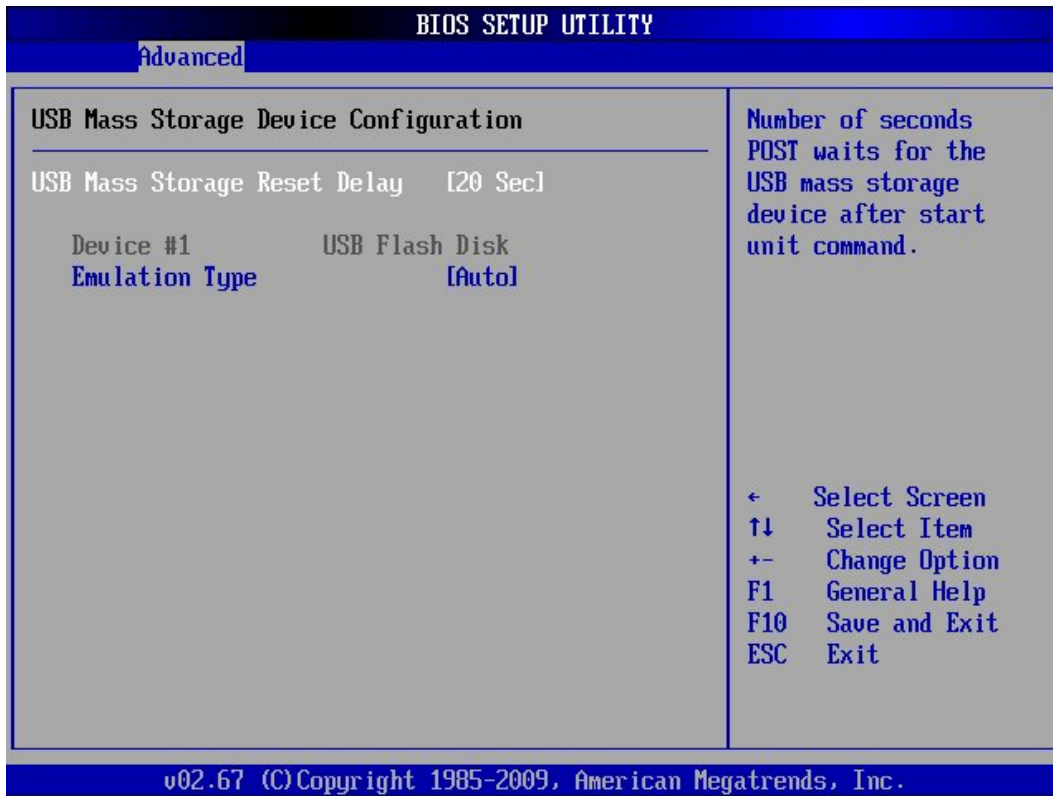

#### 10.3.5.5. USB Mass Storage Reset Delay

This option specifies amount of time the BIOS USB code should wait after issuing a reset to the USB mass storage devices (only needed for slow starting devices).

It is possible to choose between: *10 Sec*, **20 Sec**, *30 Sec*, and *40 Sec*.

#### 10.3.5.6. Emulation Type

This option specifies the type of emulation provided by the BIOS for the device.

It is possible to choose between: **Auto**, *Hard Disk*, *CD-ROM*, *Floppy* and *Forced FDD*.

<b>Auto</b>	When this option is selected the BIOS detects the current formatted media.
<i>Hard Disk</i>	This option allows the device to be emulated as hard disk.
<i>CD-ROM</i>	This option allows the device to be emulated as a CD-ROM (if the block size of the media is greater than 512 bytes).
<i>Floppy</i>	This option allows the device to be emulated as floppy drive.
<i>Forced FDD</i>	This option allows a hard disk image to be connected as a floppy image.

### 10.3.6. Event Log Configuration (Event Logging details)

AMI BIOS logs certain events to be event log, which can be configured using these options.

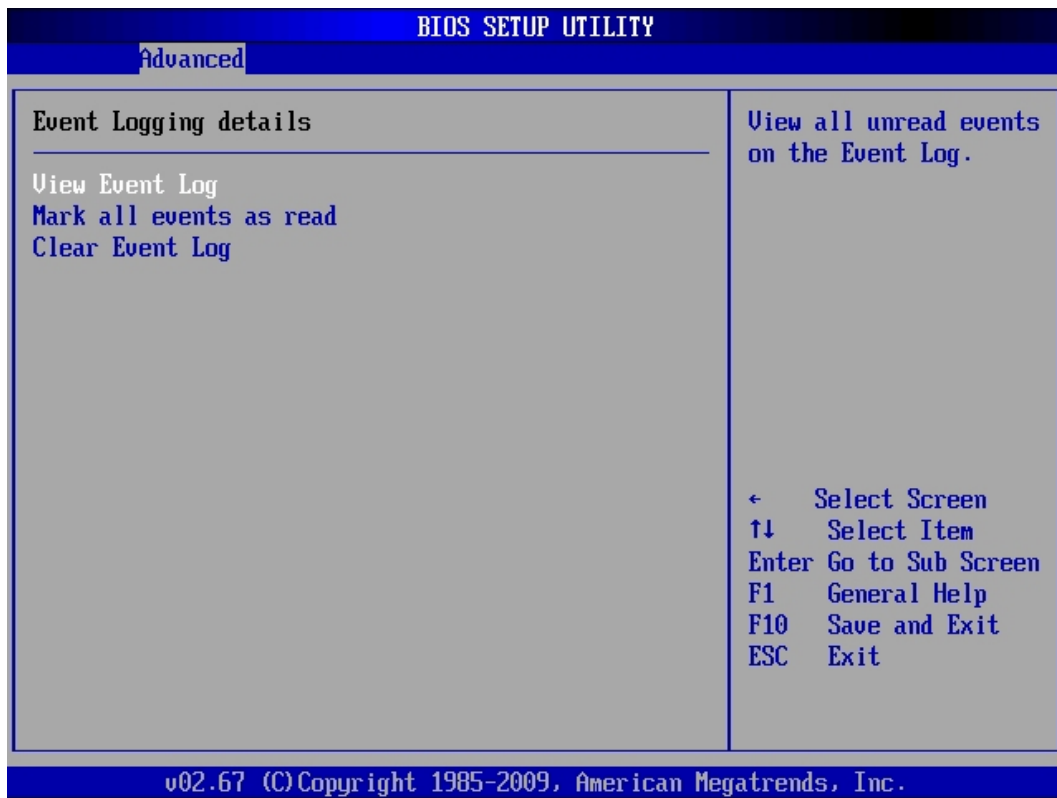

#### 10.3.6.1. View Event Log

This selection allows you to view the event log.

#### 10.3.6.2. Mark all events as read

This selection allows you to set the events as already read.

#### 10.3.6.3. Clear Event Log

This selection allows you to clear all events in the event log.

### 10.3.7. Remote Access Configuration (Configure Remote Access type and parameters)

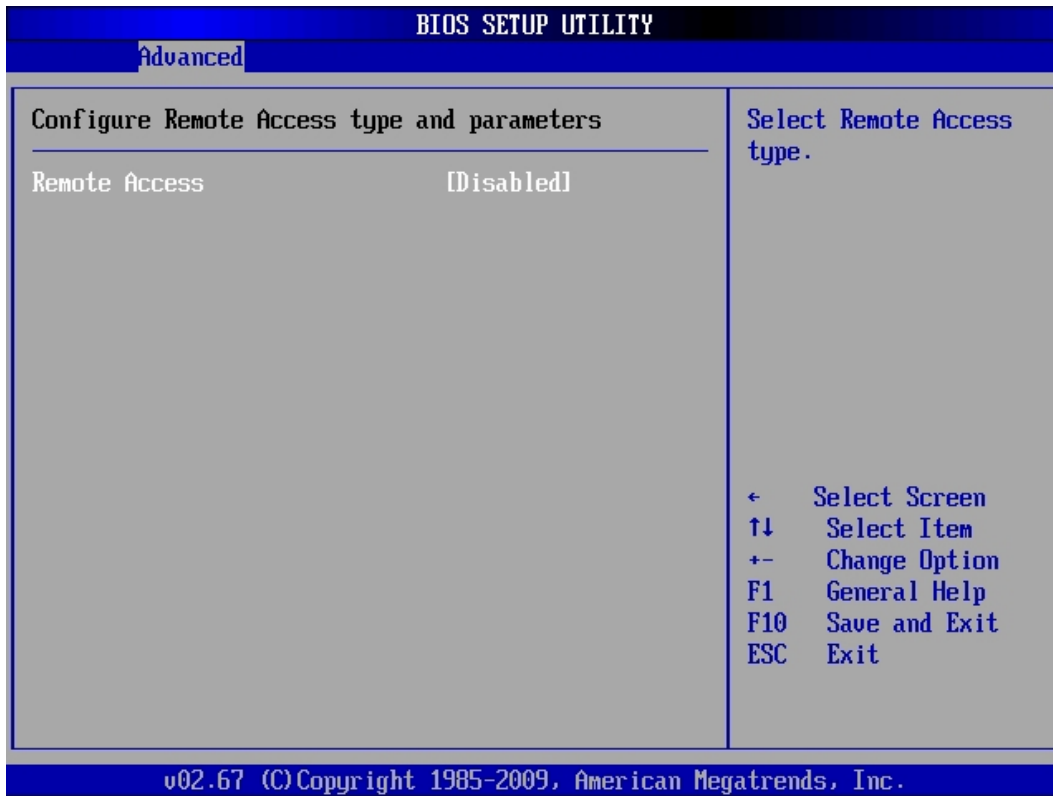

#### 10.3.7.1. Remote Access

This option allows you to enable or disable the console redirection features.

Available settings are: *Enabled* and **Disabled**.

If this option is set to "*Enabled*" are available following options:

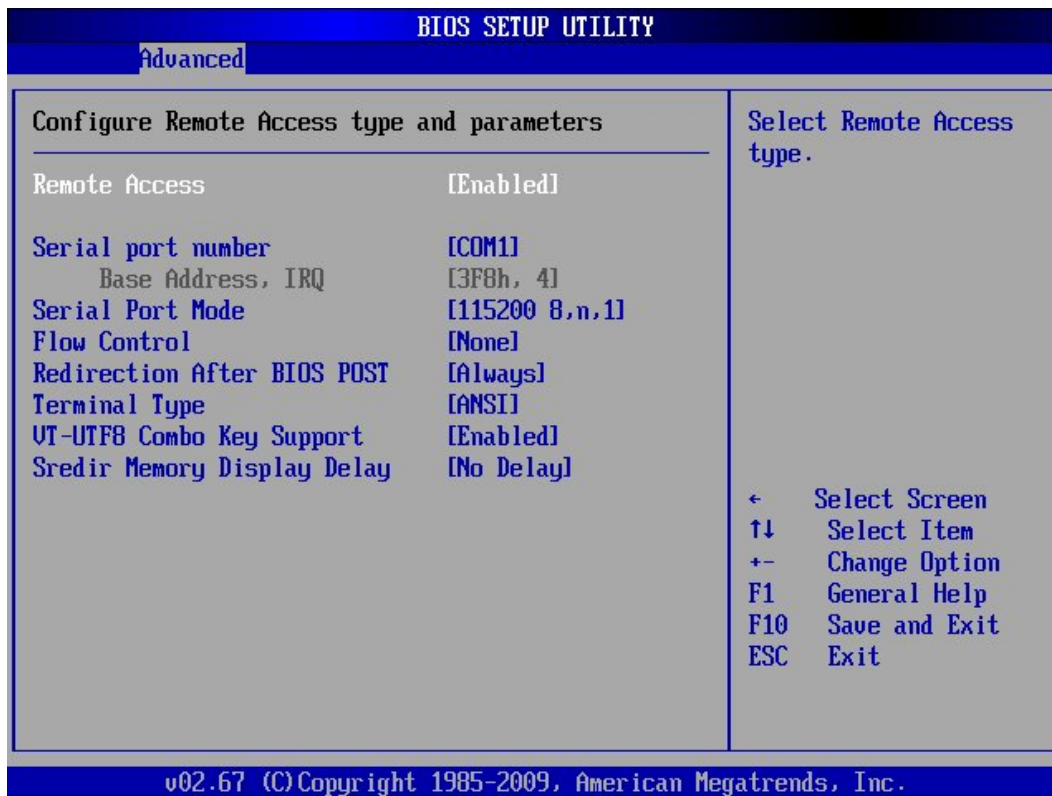



### 10.3.7.2. Serial port number

This option allows you to select the serial port for console redirection.

The available settings are: **COM1** **COM2** and **COM3**.



The COM 3 interface is an internal virtual serial interface of the ICH9DO that allows remote access via the LAN1 (AMT LAN Controller).

### 10.3.7.3. Serial Port Mode

This option allows you to select the serial port features (Speed, Data Bits, Parity, StopBits) for a proper data transfer with the client system.

The available settings are: **115200 8,n,1** / 57600 8,n,1 / 38400 8,n,1 / 19200 8,n,1 / 09600 8,n,1.

### 10.3.7.4. Flow Control

Flow Control lets computers (host and client) tell each other when they can accept more data for transmission and when to wait. This handshaking prevents data from being lost because one computer was busy.

The available settings are: **None**, **Hardware** and **Software**.

### 10.3.7.5. Redirection After BIOS POST

This option allows you to select when the console redirection will be used.

<b>Always</b>	Redirection is always active. (Some OSs may not work like expected if this setting is chosen.)
<b>Boot Loader</b>	Redirection is active during POST and during Boot Loader.
<b>Disabled</b>	Turns off the redirection after POST.

### 10.3.7.6. Terminal Type

This option allows you to select the target terminal type.

The available settings (industry standard terminal protocol) are: **ANSI**, **VT 100** and **VT-UTF8**.

### 10.3.7.7. VT-VTF8 Combo Key Support

This option allows you to enable or disable the VT-UTF8 Combo Key Support for ANSI/VT 100 terminals.

It is possible to choose between: **Enabled** and **Disabled**.



Client and target systems must have the same settings for a working communication.

### 10.3.7.8. Sredir Memory Display Delay

This option allows you to pause the memory display during redirection for the set value.

Available settings are: **No Delay**, **Delay 1 Sec**, **Delay 2 Sec** and **Delay 4 Sec**.

### 10.3.8. ACPI Configuration

ACPI Configuration settings allow you to select the Advanced Power Management (APM) options.

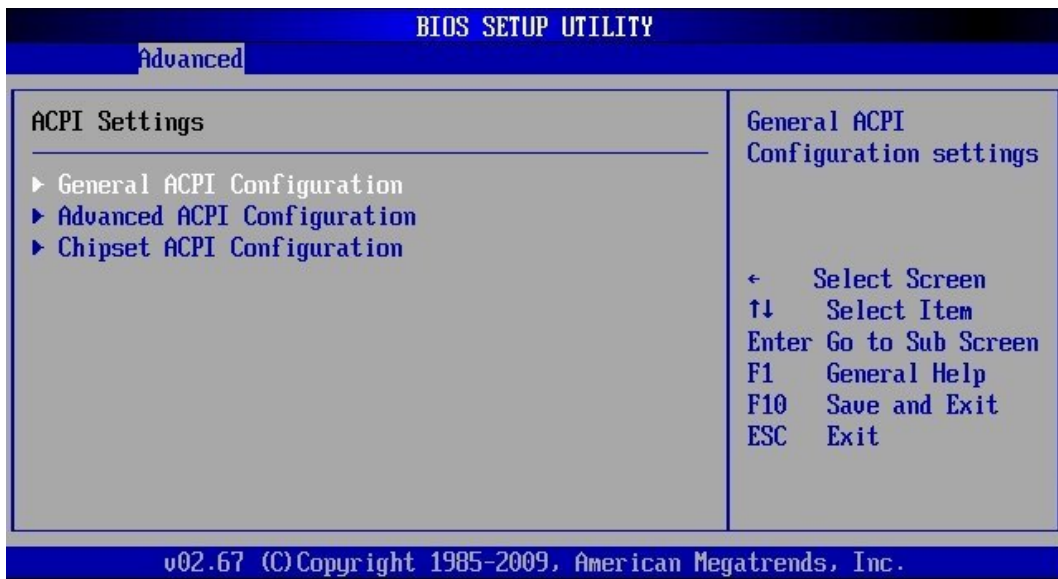

#### ➤ General ACPI Configuration

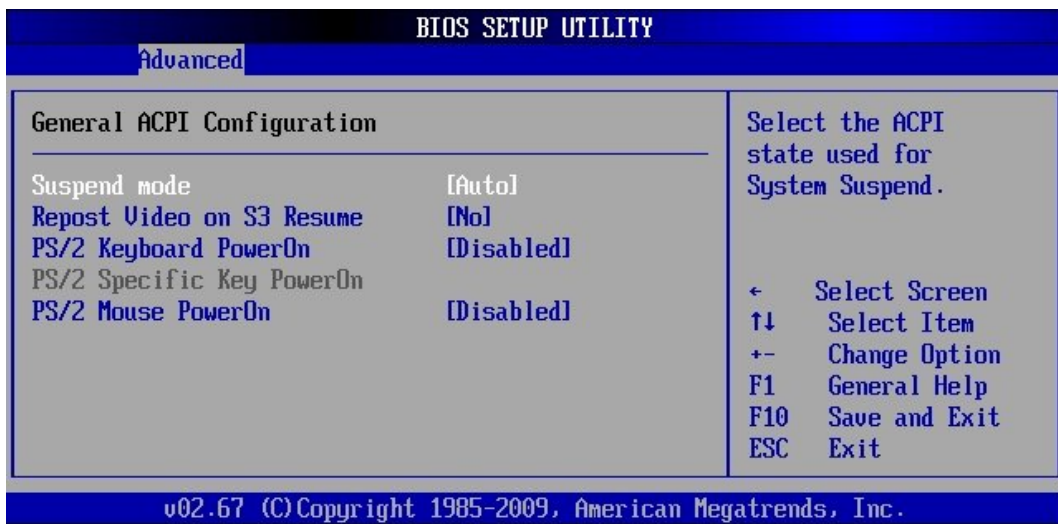

#### 10.3.8.1. Suspend Mode

This option allows you to select the ACPI state used for System Suspend.

Available settings: **Auto**, *S1 (POS)* and *S3 (STR)*.

#### 10.3.8.2. Repost Video on S3 Resume

The settings of this option allows or prevents the video BIOS to be initialized coming out of the S3 state.

Available settings: Yes and **No**.

#### 10.3.8.3. PS/2 Keyboard PowerOn

This option allows you to wake up the system via PS/2 Keyboard.

Available settings: *Specific Key*, *Any Key* and **Disabled**.

#### 10.3.8.4. PS/2 Mouse PowerOn

This option allows you to wake up the system via PS/2 Mouse.

Available settings: *Left Button*, *Right Button* and **Disabled**.

➤ **Advanced ACPI Configuration**

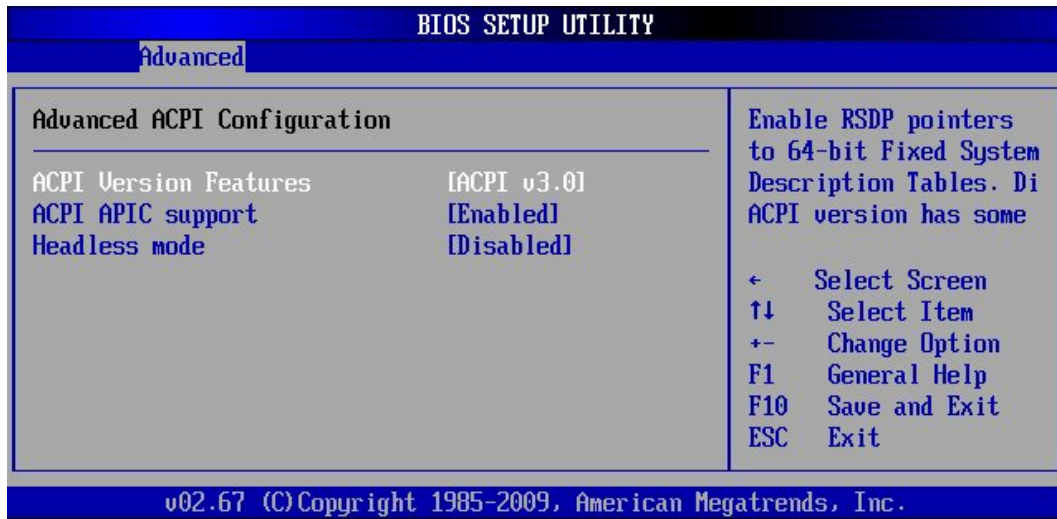

**10.3.8.5. ACPI Versions Features**

This option allows you to set the corresponding ACPI version.

It is possible to choose between: *ACPI v1.0*, *ACPI v2.0* and **ACPI v3.0**.

**10.3.8.6. ACPI APIC support**

This option determines whether or not to include the ACPI APIC table pointer to the RSDT pointer list.

It is possible to choose between: **Enabled** and *Disabled*.

<b>Enabled</b>	This setting will initiate ACPI APIC support.
<i>Disabled</i>	This setting disables ACPI APIC support.

**10.3.8.7. Headless mode**

This option is used to update the ACPI FACP table to indicate headless operations.

It is possible to choose between: *Enabled* and **Disabled**.

<i>Enabled</i>	This option enables updating the ACPI FACP table to indicate headless operation.
<b>Disabled</b>	This option disables updating the ACPI FACP table to indicate headless operation.

➤ **Chipset ACPI Configuration (South Bridge ACPI Configuration)**

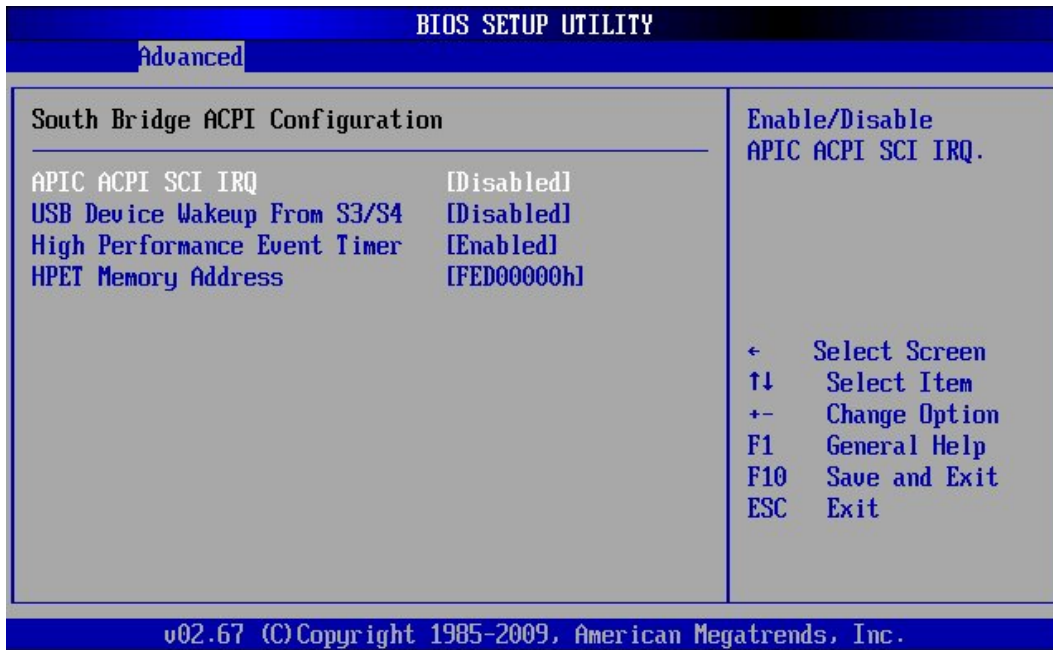

#### 10.3.8.8. APIC ACPI SCI IRQ

This option allows you to enable or disable the APIC ACPI IRQ function.

Available settings: *Enabled* and *Disabled*.

#### 10.3.8.9. USB Device Wakeup From S3/S4

This option allows you to enable or disable the wakeup function from the S3/S4 state.

Available settings: *Enabled* and *Disabled*.

#### 10.3.8.10. High Performance Event Timer

This option allows you to enable or disable the HPET (High Performance Event Timer).

Available settings: *Enabled* and *Disabled*.

#### 10.3.8.11. HPET Memory Address

This option is available only if the [High Performance Event Timer] is set to "*Enabled*".

Available settings: *FED00000h* / *FED01000h* / *FED02000h* and *FED03000h*.

### 10.3.9. MPS Configuration

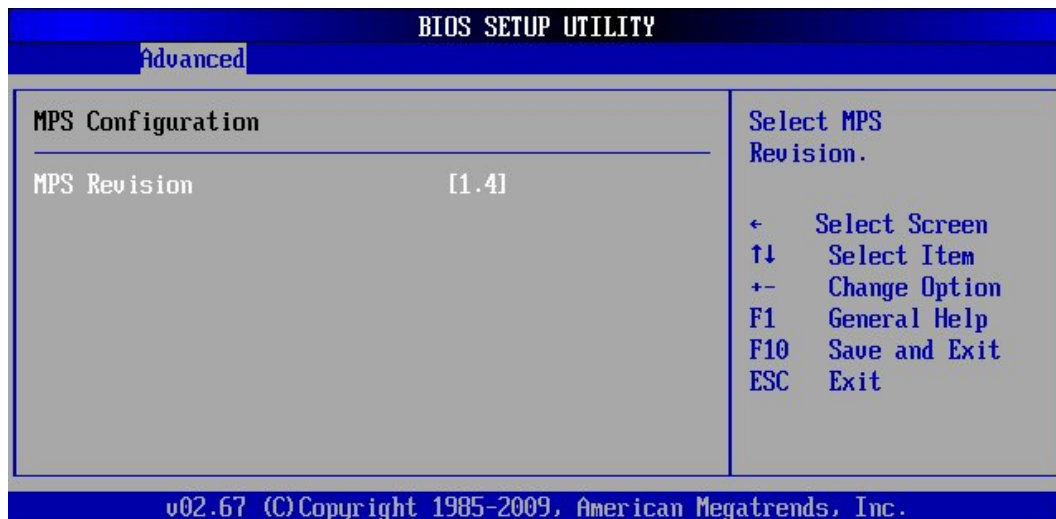

This field allows you to select which MPS (Multi-Processor Specification) version is used. You have to select the MPS version supported by your operating system.

Available settings are: **1.4** and **1.1**.

### 10.3.10. Trusted Computing

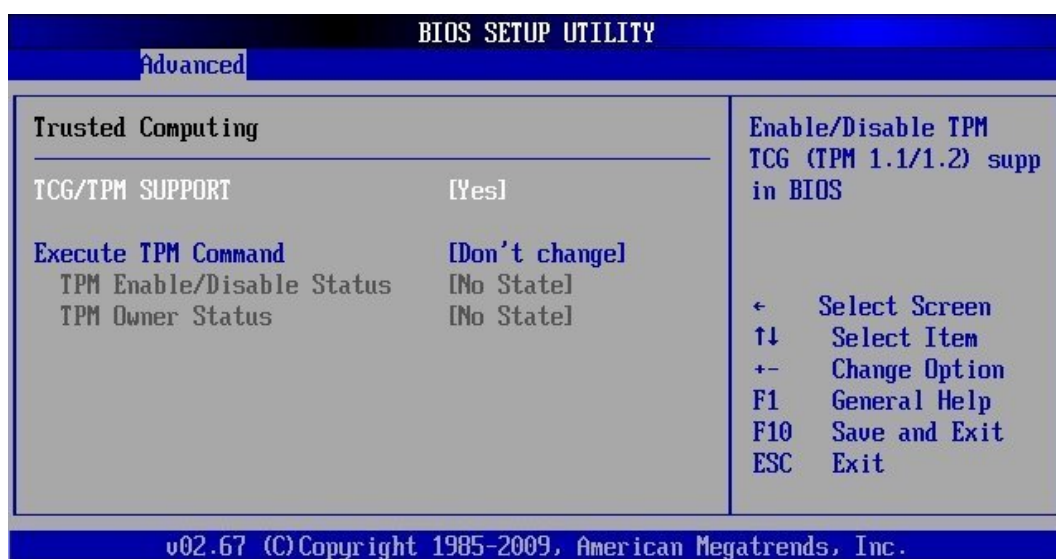

#### 10.3.10.1. TCG/TPM Support

This option allows you to enable or disable the TPM TCG (TPM 1.1/1.2) support in BIOS.

Available settings are: **Yes** and **No**.

#### 10.3.10.2. Execute TPM Command

This option allows you to enable (activate), to disable (deactivate) the initialization of the TPM (Trusted Platform Module).

Available settings are: **Don't change**, **Disabled** and **Enabled**.

If the option [TCG/TPM Support] is set to "**No**" the option [Execute TPM Command] is not available.

## 10.3.11. ASF Configuration

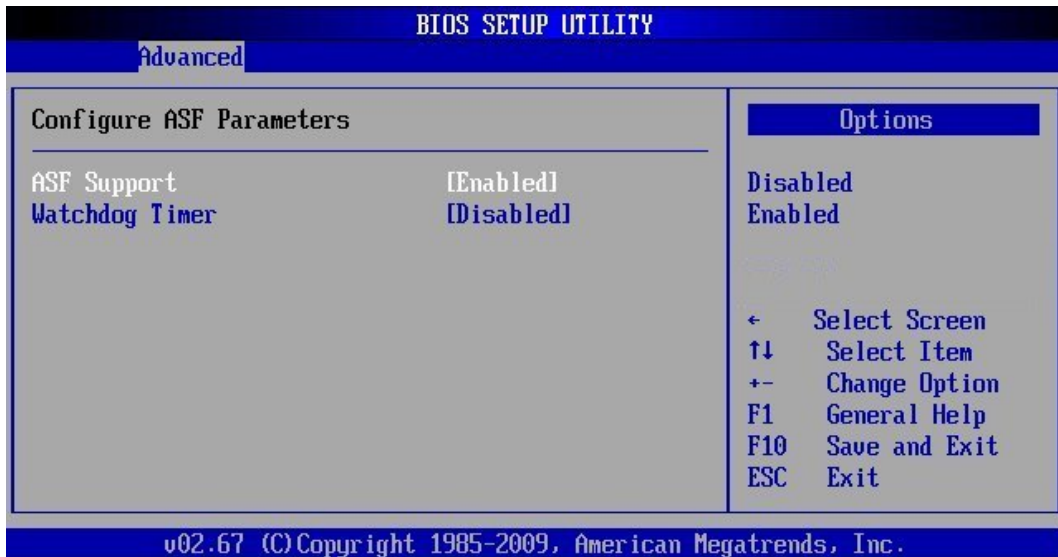

**ASF Support** with available settings: *Enabled* and *Disabled*.

**Watchdog Timer** with available settings: *Enabled* and *Disabled*.



For more information refer to the ASF (**A**lert **S**tandard **F**ormat) 2.0 specification, which defines alerting and remote-control interfaces.

## 10.3.12. Intel AMT Configuration [Configure Intel AMT Parameters]



For Information refer to Intel® Active Management Technology.

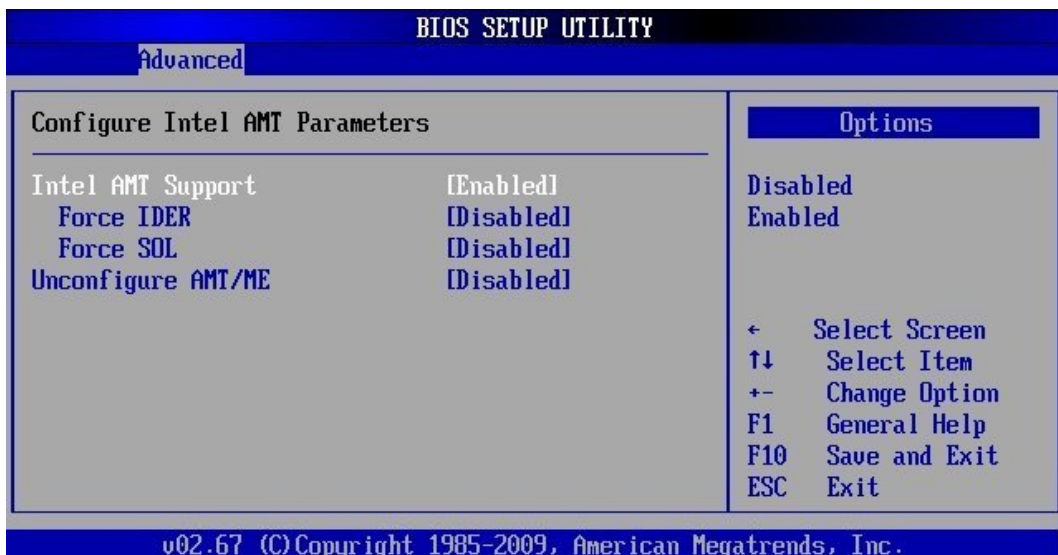

## 10.3.12.1. Intel AMT Support

Available settings: *Enabled* and *Disabled*.

**Force IDER:** Available settings: IDER Pri. Master, IDER Pri Slave, IDER Sec. Master, IDER Sec. Slave and *Disabled*.

**Force SOL:** Available settings: *Enabled* and *Disabled*.

## 10.3.12.2. Unconfigure AMT/ME

Available settings: *Enabled* and *Disabled*.



### 10.3.13. Intel TXT (LT) Configuration [Configure Intel TXT (LT) Parameters]

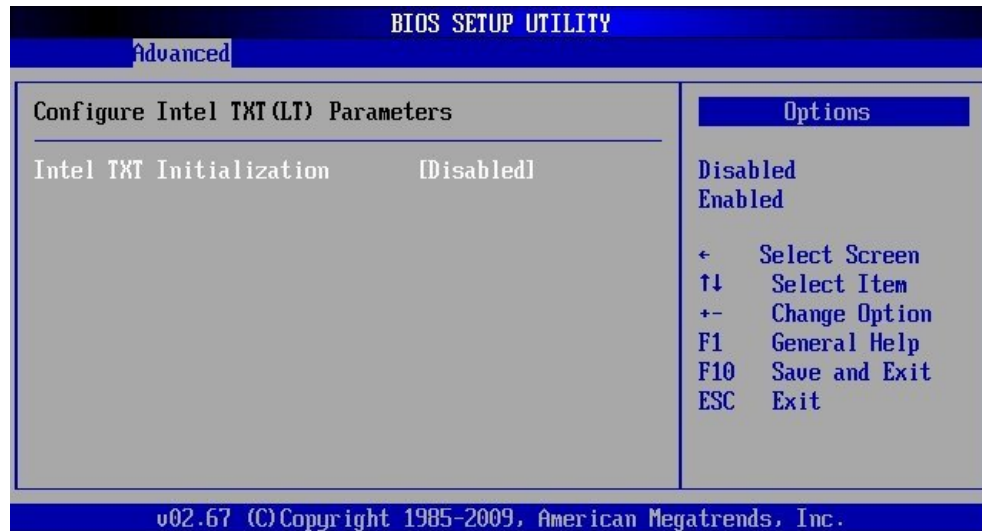

#### 10.3.13.1. Intel TXT Initialization

This option allows you to configure Intel TXT Tech. Available settings: *Enabled* and *Disabled*.

### 10.3.14. Intel VT-d Configuration

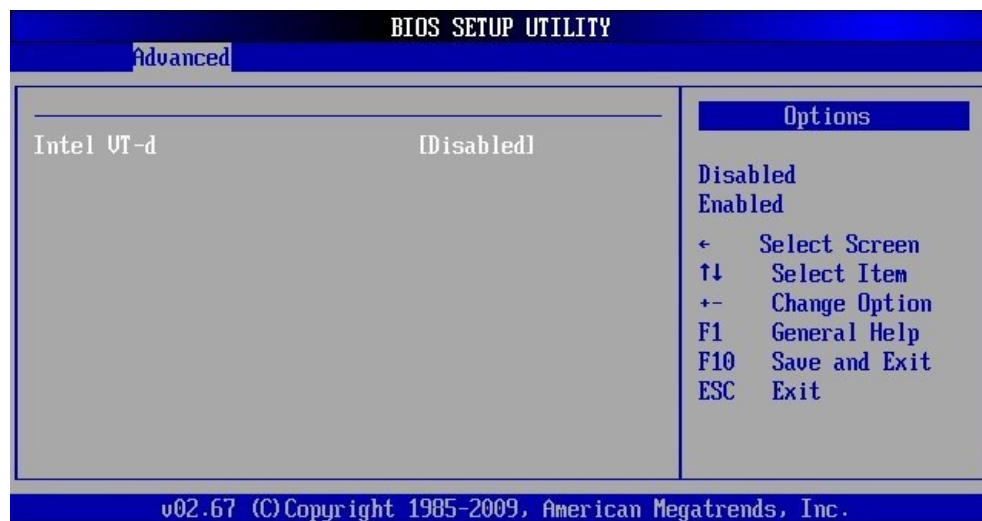

This option allows you to configure Intel VT-d Tech. Available settings: *Enabled* and *Disabled*.

### 10.3.15. Intel VA Configuration (Configure Intel VA Parameters)

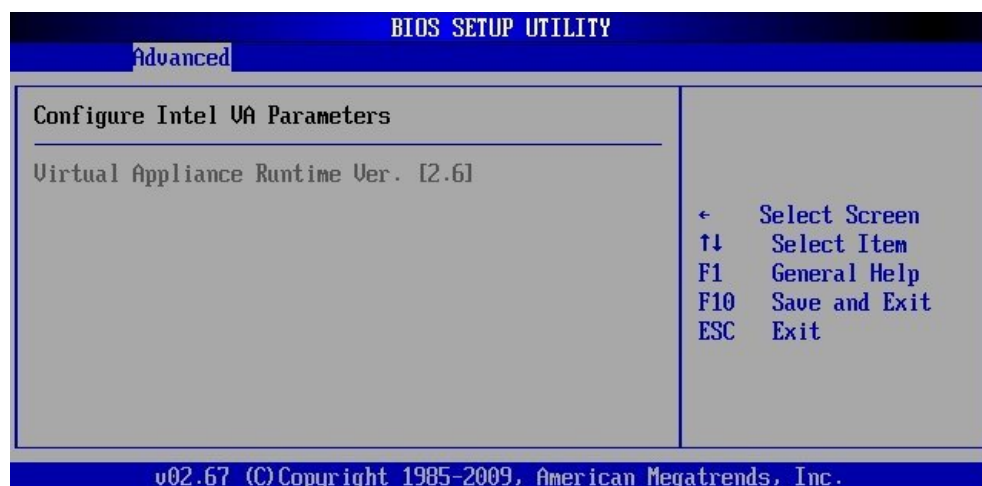

## 10.4. PCIPnP

The "PCI PnP Configuration" section of the BIOS controls the settings for the onboard PCI slots.

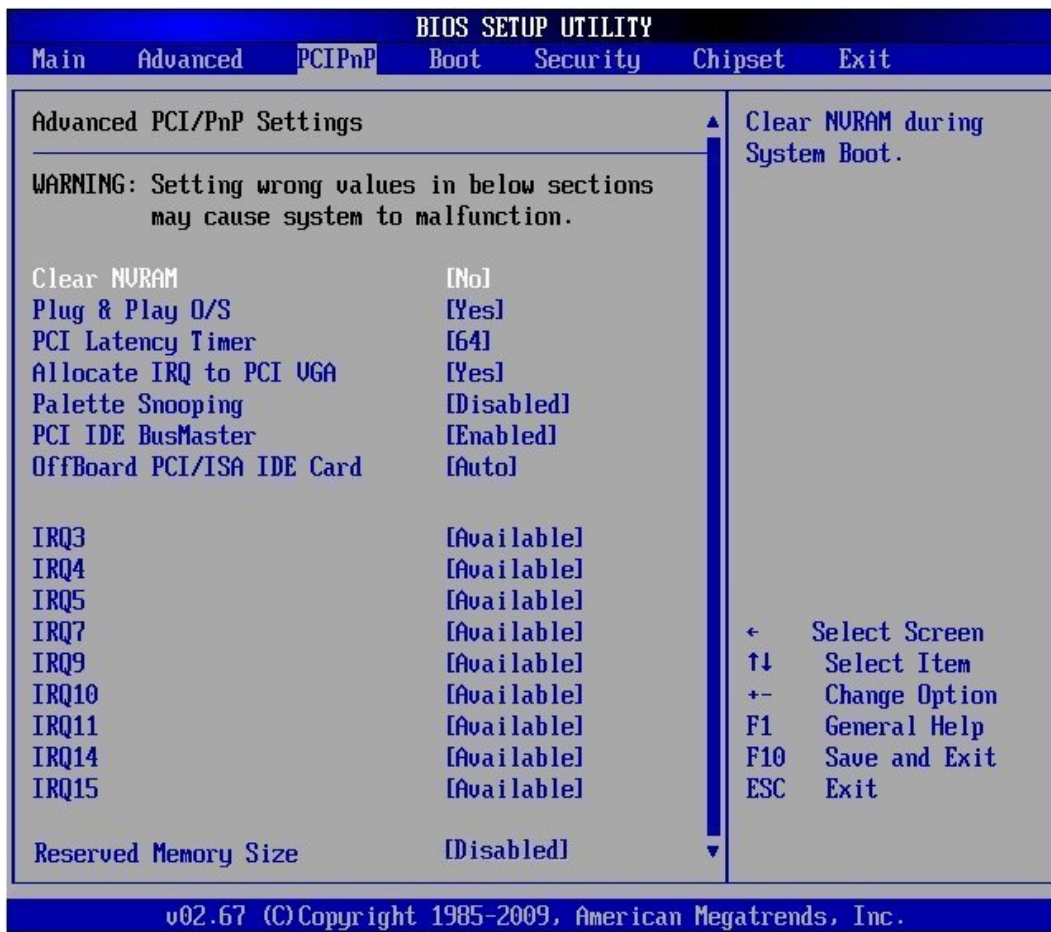

### 10.4.1.1. Clear NVRAM

This option allows you to clear the NVRAM during the system boot.

The available settings are: **No** and **Yes**.

### 10.4.1.2. Plug & Play O/S

This field determines the Plug&Play function. Plug&Play means that added components are automatically recognized and installed if they support automatic recognition.

The available settings are: *No* and **Yes**.

<b>No</b>	The system BIOS assumes the recognition of the components and assigns the resources (e.g. DOS, WIN3.1).
<b>Yes</b>	The operating system assumes part of the Plug&Play functions. This setting should only be selected if the operating system supports Plug&Play (e. g. Windows 95 or higher) (e.g. Windows 2000, XP, Modem, LINUX).

### 10.4.1.3. PCI Latency Timer

This choice specifies, how long (PCI clock) a PCI card can still use the PCI Bus as master, if another PCI card requests the access to the PCI Bus.

The available settings are: 32, **64**, 96, 128, 160, 192, 224 and 248.



**10.4.1.4. Allocate IRQ to PCI VGA**

This option allows or restricts the system to allocate an IRQ to a VGA adapter card that uses the PCI Bus.

The available settings are: **Yes** and *No*.

<b>Yes</b>	Assigns an IRQ to PCI VGA card if the card requests an IRQ.
<i>No</i>	Does not assign an IRQ to a PCI VGA card even if the card requests an IRQ.

**10.4.1.5. Palette Snooping**

This option allows the compliance of older higher resolution video cards to the VGA standard. As presently all video boards are compliant to this standard, this option must stay **Disabled**.

This default setting should not be changed unless the VGA card manufacturer requires Palette Snooping to be "*Enabled*".

The available settings are: *Enabled* and **Disabled**.

**10.4.1.6. PCI IDE BusMaster**

If this option is „Enabled“, the BIOS uses busmastering for reading/writing to IDE drives.

The available settings are: **Enabled** and *Disabled*.

**10.4.1.7. OffBoard PCI/ISA IDE Card**

This option is to be used if an offboard PCI/ISA IDE controller adapter card is installed in the system.

The settings of this option allow you to specify the PCI expansion slot on the motherboard where the offboard PCI/ISA controller is installed.

The available settings are: *PCI Slot1*, *PCI Slot2*, *PCI Slot3*, *PCI Slot4*, *PCI Slot5*, *PCI Slot6*, and **Auto**.

**10.4.1.8. IRQ3, IRQ4, IRQ5, IRQ7, IRQ9, IRQ10, IRQ11, IRQ14, IRQ15**

These options allow you to configure the IRQ Resources.

Available settings are: **Available** and *Reserved*.

<b>Available</b>	This setting allows the specified IRQ to be used by PCI/PnP device.
<i>Reserved</i>	This setting allows the specified IRQ to be used by a legacy ISA device.

**10.4.1.9. DMA Channel 0, DMA Channel 1, DMA Channel 3, DMA Channel 5, DMA Channel 6, DMA Channel 7**

These options allow you to configure the DMA channels.

Available settings are: **Available** and *Reserved*.

<b>Available</b>	This setting allows the specified DMA channel to be used by PCI/PnP device.
<i>Reserved</i>	This setting allows the specified DMA channel to be used by a legacy ISA device.

#### 10.4.1.10. Reserved Memory Size

This option allows you to specify the memory size for the ISA extension cards (only to be used if the ISA-Bridge is equipped on the backplane).

Available settings are: *16k*, *32k*, *64k* and **Disabled**.

If this option is enabled to *16k*, *32k* or *64k* a supplementary option is available: “**Reserved Memory Address**”.

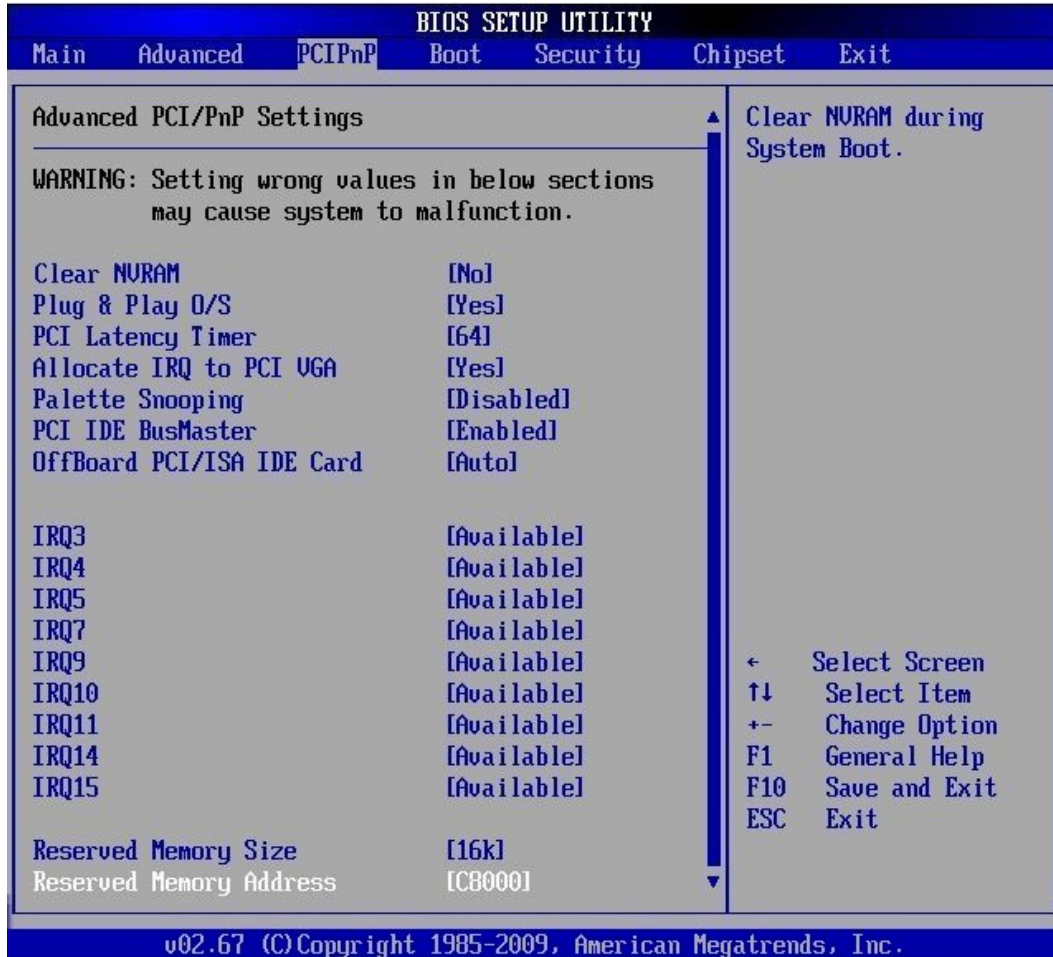

#### 10.4.1.11. Reserved Memory Address

This option allows you to specify the memory size for the ISA extension cards in the reserved memory address.

Available settings are: C0000, C4000, **C8000**, CC000, D0000, D4000, D8000 and DC000.



For a proper ISA card installation, set the same values of the BIOS options “Reserved Memory Size” and “Reserved Memory Address” like on the OS level and/or driver level (depending on the installed ISA card).

## 10.5. Boot

In the Boot menu you define the sequence in which the system BIOS searches the drives for system files to start the operating system.

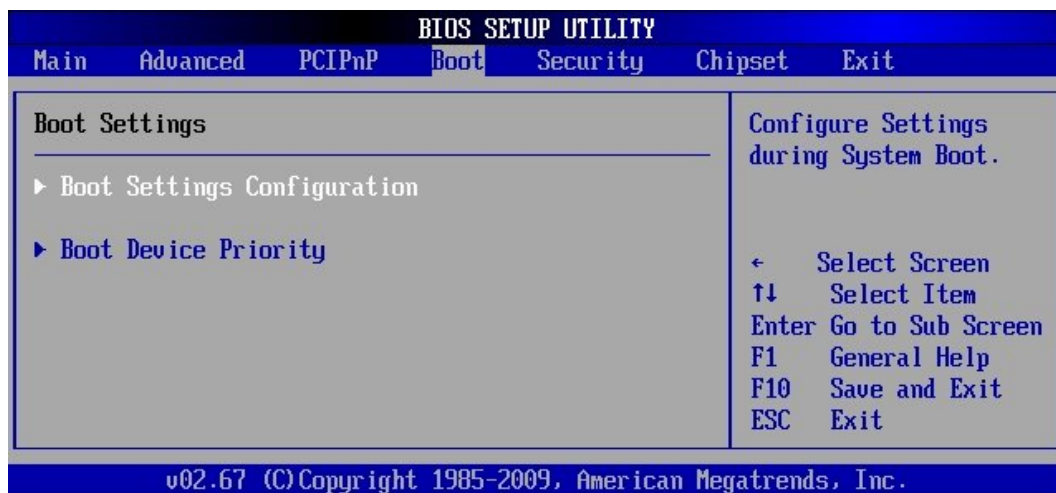

### ➤ Boot Settings Configuration

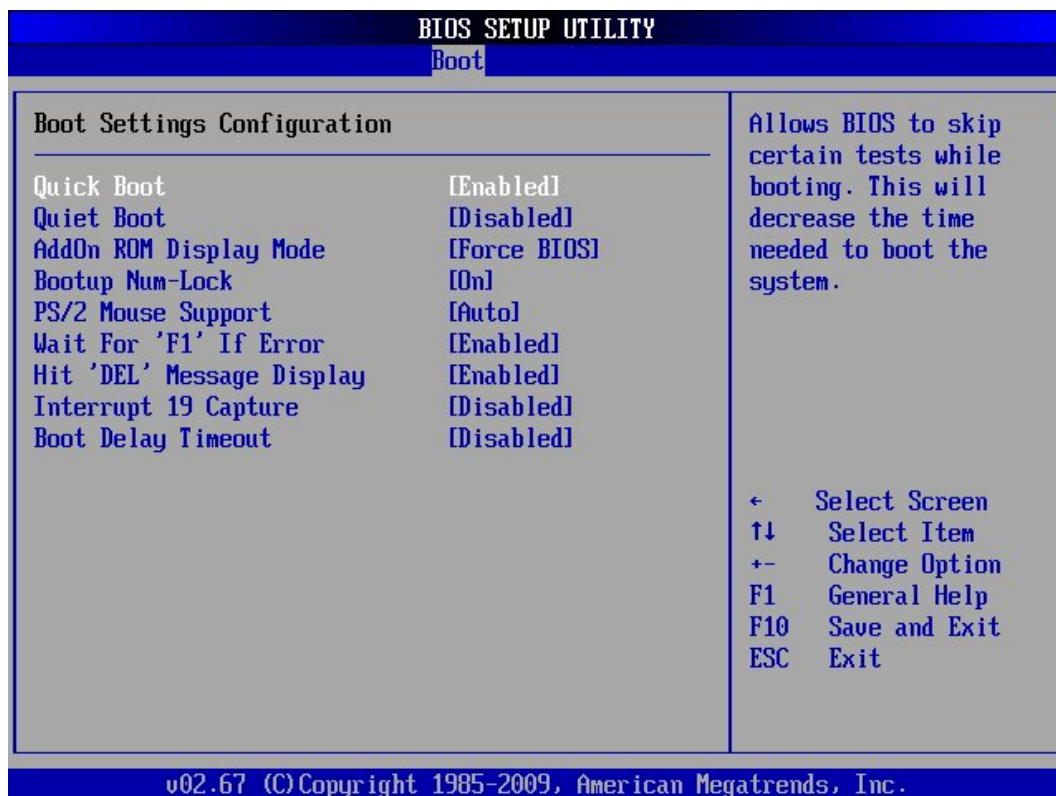

#### 10.5.1.1. Quick Boot

This option allows or restricts the BIOS to perform all POST tests.

It is possible to choose between: **Enabled** and *Disabled*.

<b>Enabled</b>	This setting allows the BIOS to skip certain POST tests to boot faster.
<i>Disabled</i>	This setting allows the BIOS to perform all POST tests.

**10.5.1.2. Quiet Boot**

This option allows you to modify the boot up screen settings between POST messages or OEM logo.

It is possible to choose between: *Enabled* and *Disabled*.

<i>Enabled</i>	This setting allows the computer system to display the OEM logo instead of POST messages.
<i>Disabled</i>	This setting allows the computer system to display the POST messages.

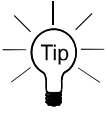

If this option is *Enabled* the installed AMI-Logo (or a customized Company-Logo, if ordered) will be displayed during POST.

**10.5.1.3. AddOn ROM Display Mode**

This option can be used to display add-on ROM (read-only memory) messages (e.g. the SCSI BIOS or VGA BIOS).

It is possible to choose between: **Force BIOS** and *Keep Current*.

<i>Keep Current</i>	A third party BIOS messages are not displayed during system boot.
<b>Force BIOS</b>	This setting allows the computer system to force a third party BIOS to display its messages during system boot.

**10.5.1.4. Bootup Num-Lock**

Set this value to allow the Number Lock setting to be modified during boot up.

It is possible to choose between: **On** and *Off*.

<b>On</b>	Set this value to allow the Number Lock on the keyboard to be enabled automatically when the computer system is boot up. This allows the immediate use of 10-keys numeric keypad located on the right side of the keyboard. To confirm this, the Number Lock LED light on the keyboard will be lit. This is the default setting.
<i>Off</i>	This option does not enable the keyboard Number Lock automatically. To use the 10-keys on the keyboard, press the Number Lock key located on the upper left-hand corner of the 10-key pad. The Number Lock LED on the keyboard will light up when the Number Lock is engaged.

**10.5.1.5. PS/2 Mouse Support**

This option allows you to activate or to restrict the PS/2 mouse support.

It is possible to choose between: **Auto**, *Enabled* and *Disabled*.

<i>Enabled</i>	Set this value to force the system to reserve an IRQ for PS/2 devices.
<i>Disabled</i>	This option will prevent the PS/2 mouse port from using system resources and will prevent the port from being active. Use this setting if you want to install an external serial mouse.
<b>Auto</b>	Set this value to allow the BIOS to auto-detect a PS/2 mouse and to reserve the resources for it.

**10.5.1.6. Wait For 'F1' If Error**

This option specifies if errors detected during the boot time, determine the interruption of the boot procedure.

It is possible to choose between: **Enabled** and **Disabled**.

<b>Enabled</b>	The boot procedure is stopped, whenever the BIOS detect an error. The system waits for a user input.
<b>Disabled</b>	The boot procedure will be not halted for any error that may be detected.

**10.5.1.7. Hit 'DEL' Message Display**

This option allows you to modify the setting for "Hit 'DEL' Message Display".

It is possible to choose between: **Enabled** and **Disabled**.

<b>Enabled</b>	This setting allows the system to display: Hit Del to enter Setup during memory initialization. If "Quiet Boot" option is enabled, the Hit 'DEL' message will not display.
<b>Disabled</b>	This setting prevents the system to display: Hit Del to enter Setup during memory initialization. If "Quiet Boot" option is enabled, the Hit 'DEL' message will not display.

**10.5.1.8. Interrupt 19 Capture**

Set this value to allow option ROMs such as network controllers to trap BIOS interrupt 19.

It is possible to choose between: **Enabled** and **Disabled**.

<b>Enabled</b>	The BIOS allows option ROMs to trap interrupt 19.
<b>Disabled</b>	The BIOS prevents option ROMs from trapping interrupt 19.

**10.5.1.9. Boot Delay Timeout**

This option allows you to enable or to disable the "Boot Delay Time out".

It is possible to choose between: **Enabled** and **Disabled**.

➤ **Boot Device Priority**

In the *Boot Device Priority* menu you define the sequence in which the system BIOS searches the drives for system files to start the operating system.

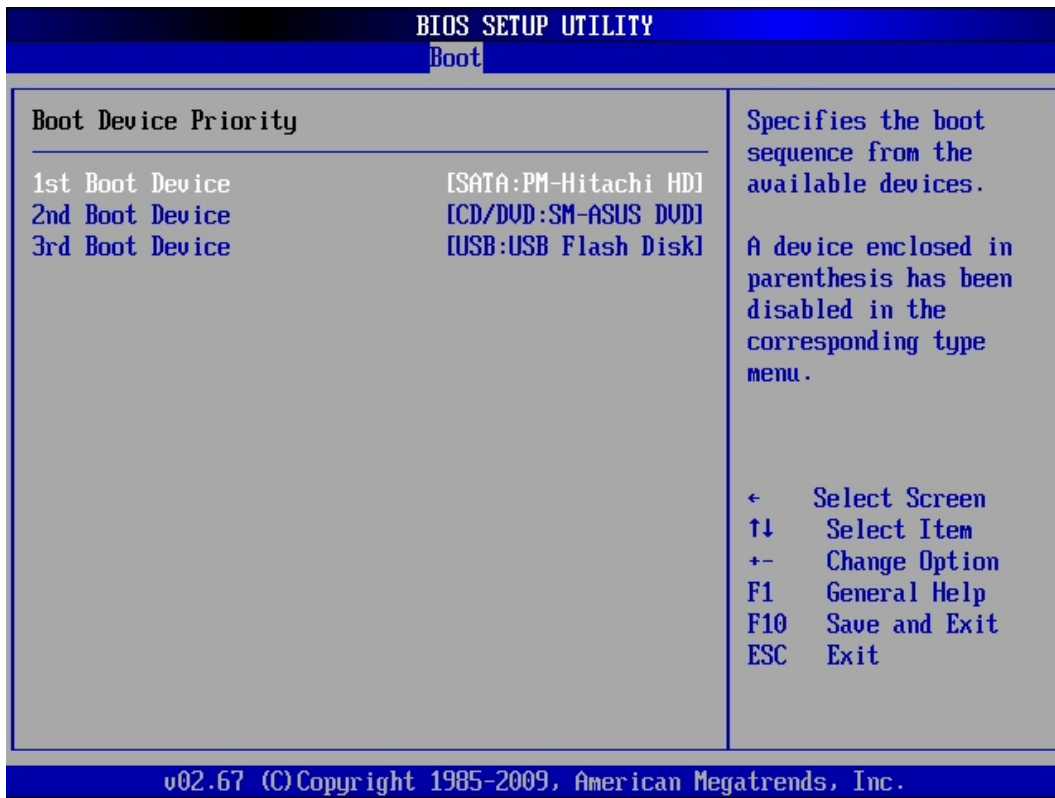

List of devices available for use as boot devices: (the possible selection is depending on the system configuration).

**10.5.1.10. 1<sup>st</sup> / 2<sup>nd</sup> , / 3<sup>rd</sup> , .... / n<sup>th</sup> Boot Device**

Available settings: [SATA: PS-WDC WD800AAJS-00PSA0]; [CD/DVD: PM-HL-DT-STDVD-ROM GDRH2]; [CD/DVD: PM-HL-DT-STDVD-ROM GDRH2]; [USB: Kingston DataTraveler]; [Network: B04 D00 Yukon PXE]; [Network: B03 D00 Yukon PXE] and Disabled.

Boot Devices (examples)		Description
1 <sup>st</sup> Boot Device	SATA: PM-Hitachi HDS721616PLA380	Primary Master (not included)
2 <sup>nd</sup> Boot Device	CD/DVD: SM-ASUS DVD-E818AT	Secondary Master (not included)
3 <sup>rd</sup> Boot Device	USB: USB Flash Disk	(not included)

In order to boot from LAN (network booting) you have to access the [BIOS Setup/Chipset/South Bridge Configuration] and set “**Enable**” for the corresponding LAN Controller and the appropriate option [LAN Boot].

Set the Network device in [BIOS Setup/Boot/Boot Device Priority] as [1st Boot Device].



Each of these changes will be adopted only, if “Save Changes and Exit” is selected after changing of the default settings. Reboot your system. Refer to the chapter “10.7.2.41. / 2. / 3. Ethernet Controller” and “10.7.2.5 LAN Boot”

Boot Devices Priority (example for Network Device as 1 <sup>st</sup> boot device)		Description
1 <sup>st</sup> Boot Device	Network: IBA GE Slot 00C8 v 1270	
2 <sup>nd</sup> Boot Device	CD/DVD: SM-ASUS DVD-E818AT	Secondary Master (not included)
3 <sup>rd</sup> Boot Device	USB: USB Flash Disk	(not included)
4 <sup>th</sup> Boot Device	SATA: PM-Hitachi HDS721616PLA380	Primary Master (not included)

## 10.6. Security

PCI-760 supports Supervisor and User password.

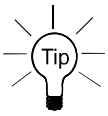

Valid password (Supervisor and User) can be a 1 to 6 alphanumeric characters combination.

If you are using both passwords the Supervisor password must be set first.

Keep a record of the new password when the password is changed. If you forget the password, you must erase the system configuration information in NVRAM.

The system can be configured so that all users must enter a password every time the system boots or when BIOS Setup is executed, using either or either the Supervisor password or User password.

The Supervisor and User passwords activate two different levels of password security.

If you select password support, you are prompted for a one to six character password. Type the password on the keyboard. The password does not appear on the screen when typed. Make sure you write it down. If you forget it, you must drain NVRAM and reconfigure.



### 10.6.1. Supervisor Password

This field indicates whether a supervisor password has been set.

If the password has been installed, *Installed* displays. If not, *Not Installed* displays.

### 10.6.2. User Password

This field indicates whether a user password has been set. If the password has been installed, *Installed* displays. If not, *Not Installed* displays.

## 10.6.2.1. Change Supervisor Password

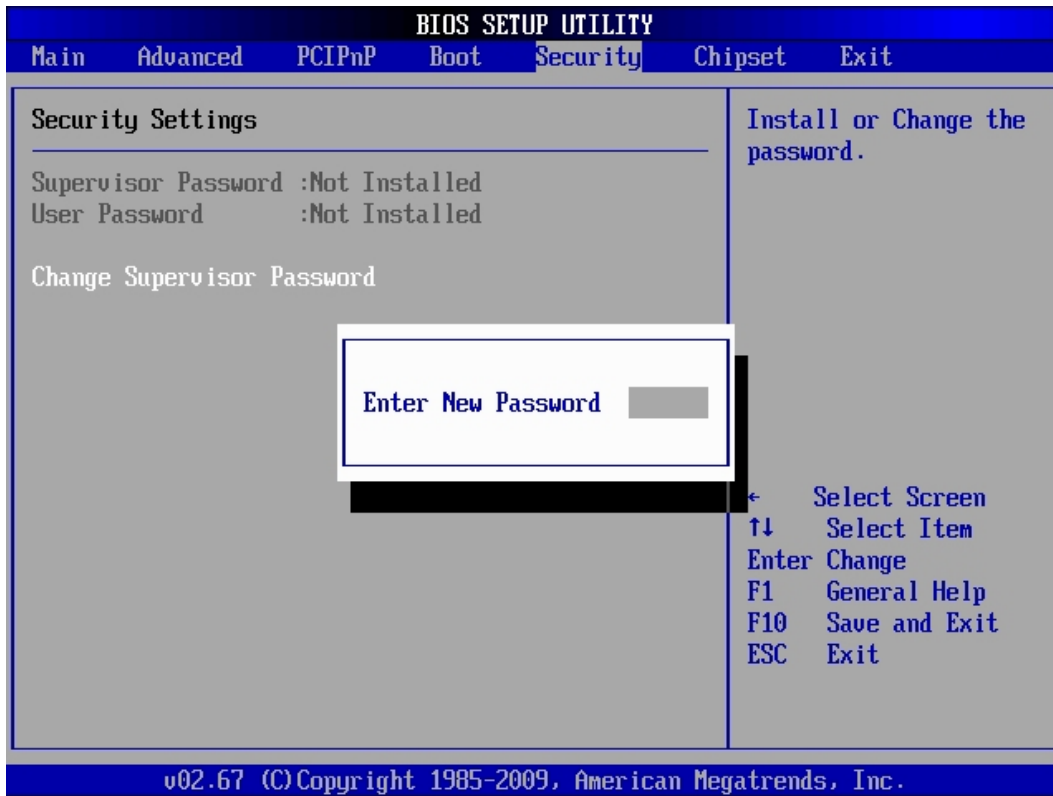

Select this option and press <Enter> to access the sub menu.

You can use the sub menu to change the supervisor password. Select the “Change Supervisor Password” option from the Security Setup menu and press <Enter>.

“Enter New Password:” input field appears. Valid password can be a 1 to 6 alphanumeric characters combination. Type the password and press <Enter>. The screen does not display the characters entered. “Confirm New Password:” input field appears. Retype the password as prompted and press <Enter>. If the password confirmation is incorrect, an error message appears. The password is stored in NVRAM.

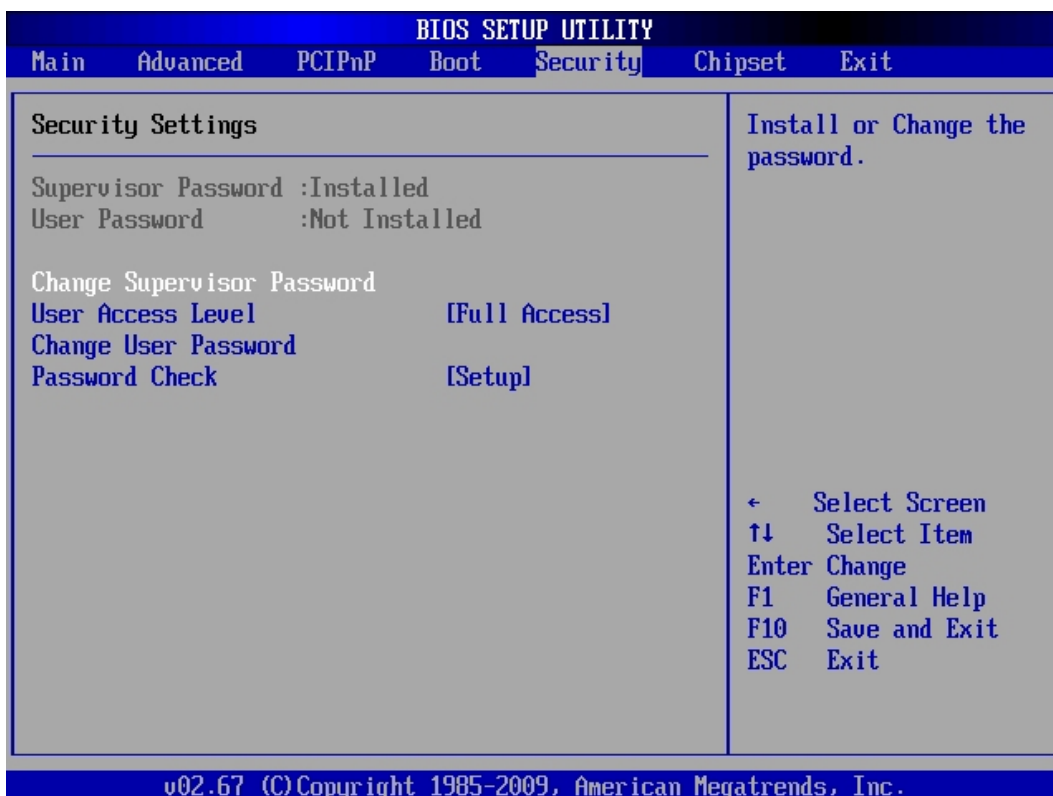



If a Supervisor Password is installed two options are available:

“**User Access Level**” with following settings: *Full Access*, *Limited*, *View Only*, and *No Access*.

“**Password Check**” with following settings: *Setup* and *Always*.

#### 10.6.2.2. Change User Password

Select this option and press <Enter> to access the sub menu.

You can use the sub menu to change the user password. Select Change User Password from the Security Setup menu and press <Enter>.

“Enter New Password:” input field appears. Valid password can be a 1 to 6 alphanumeric characters combination. Type the password and press <Enter>. The screen does not display the characters entered. “Confirm New Password:” input field appears. Retype the password as prompted and press <Enter>. If the password confirmation is incorrect, an error message appears. The password is stored in NVRAM.

If a User Password is installed are available the “**Clear User Password**” option:

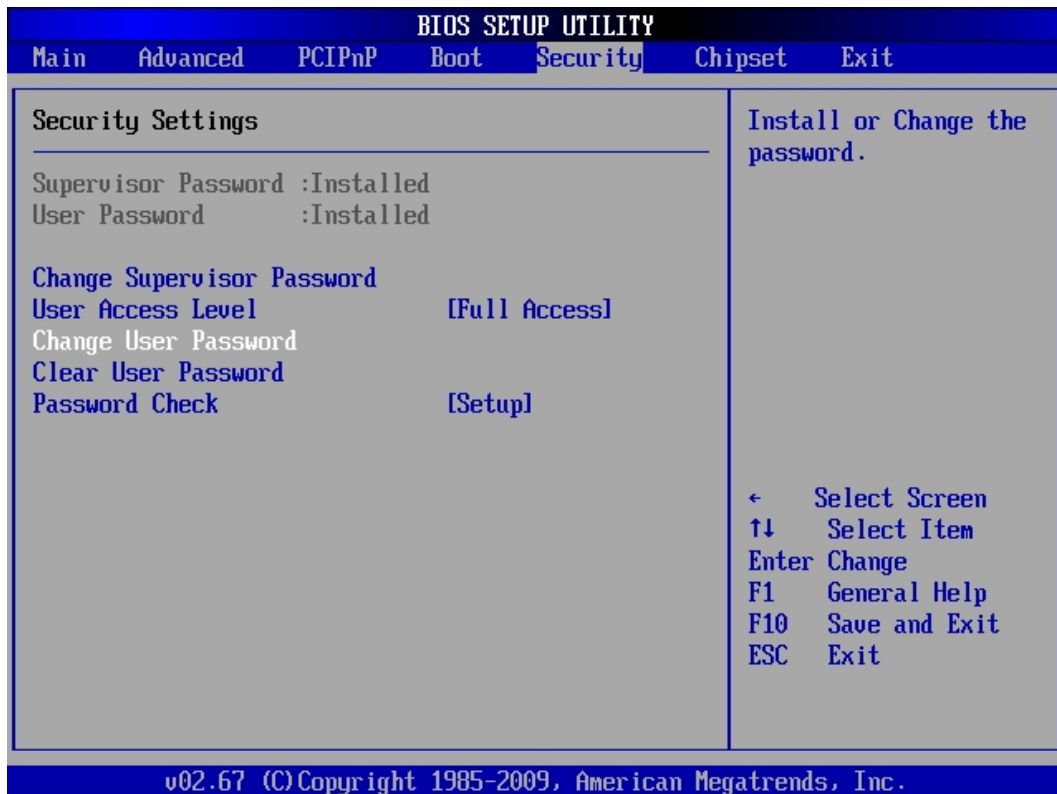

## 10.7. Chipset

All "Chipset" BIOS Setup options are described in this section. The "Chipset" BIOS Setup screen is shown below.



### 10.7.1. North Bridge Chipset Configuration

You can use this field to select options for the NorthBridge chipset configuration.

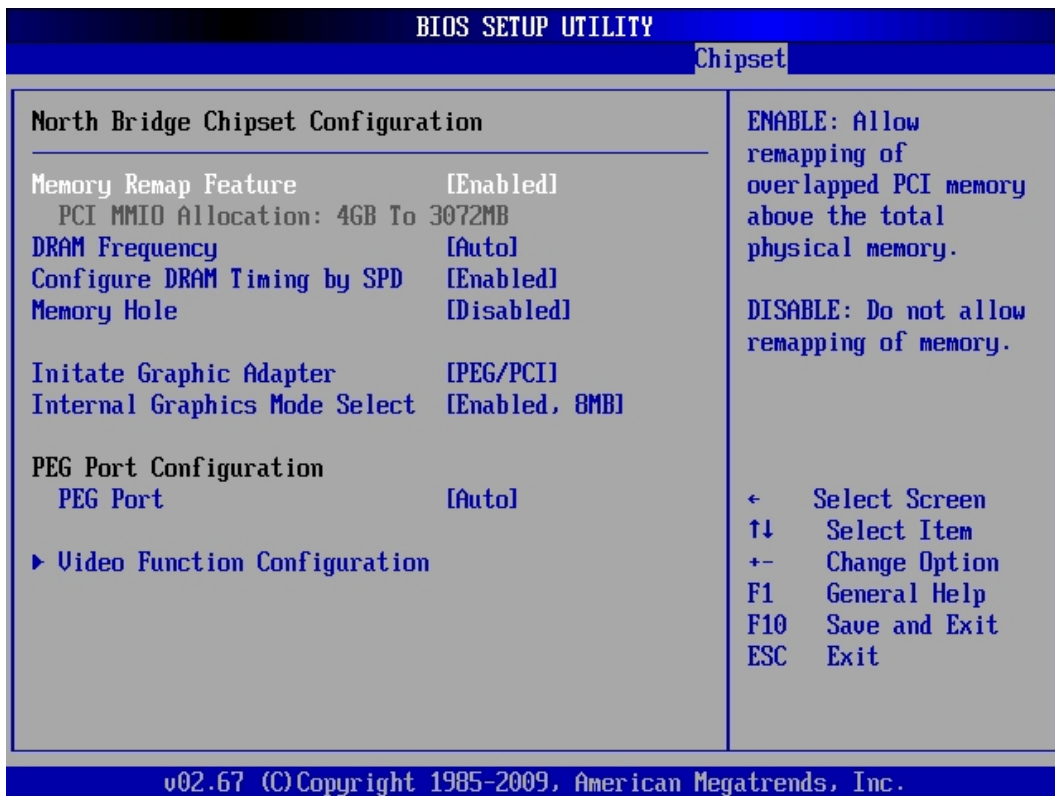

#### 10.7.1.1. Memory Remap Feature

This option allows you to enable or disable the remapping of the overlapped PCI memory above the physical memory.

The available settings are: **Enabled** and *Disabled*.

#### 10.7.1.2. DRAM Frequency

The available settings are:

**Auto**, 533 MHz, 667 MHz, 800 MHz and 1067 MHz.

### 10.7.1.3. Configure DRAM Timing by SPD

The available settings are: **Enabled** and **Disabled**.

If the [Configure DRAM Timing by SPD] option is set to “disabled” are available additional settings (refer to the picture below).

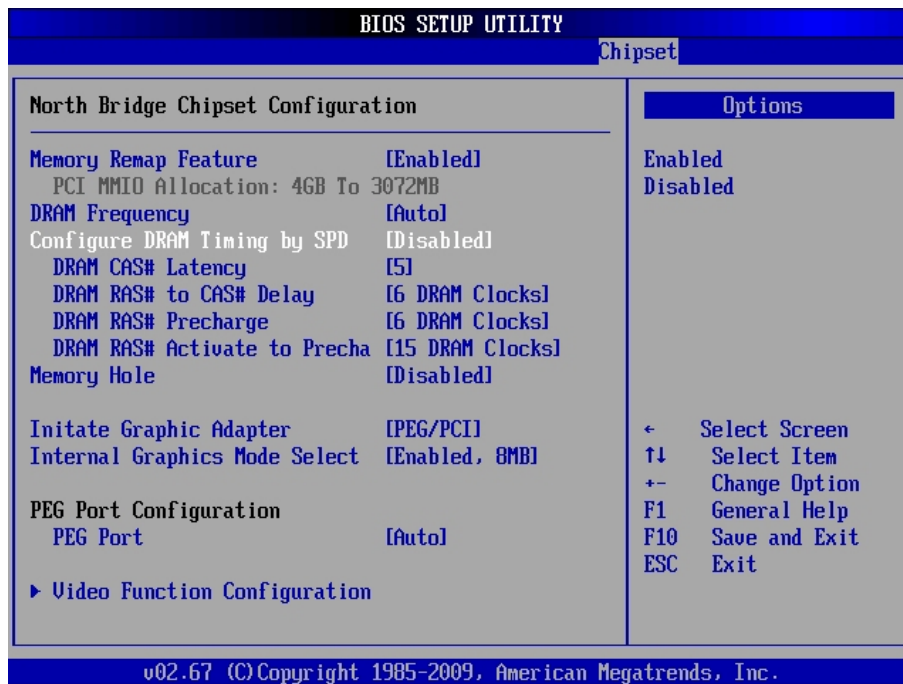

#### 10.7.1.4. DRAM CAS# Latency

Available settings: 3, 4, **5** and 6.

#### 10.7.1.5. DRAM RAS# to CAS# Delay

Available settings: 3 DRAM Clocks, 4 DRAM Clocks, 5 DRAM Clocks and **6 DRAM Clocks**.

#### 10.7.1.6. DRAM RAS# Precharge

Available settings: 3 DRAM Clocks, 4 DRAM Clocks, 5 DRAM Clocks and **6 DRAM Clocks**.

#### 10.7.1.7. DRAM RAS# Activate to Precha

Available settings: 9 DRAM Clocks, 10 DRAM Clocks, 11 DRAM Clocks, 12 DRAM Clocks, 13 DRAM Clocks, 14 DRAM Clocks and **15 DRAM Clocks**.

#### 10.7.1.8. Memory Hole

In order to improve performance, certain space in memory can be reserved for ISA cards. This memory must be mapped into the memory space 15MB-16MB.

The available settings are: 15MB-16MB and **Disabled**.

#### 10.7.1.9. Initiate Graphic Adapter

These settings allow you to select the graphics controller used as primary boot device. The available settings are: **IGD**, **PCI/IGD**.

**PEG:** PCI Express Graphics

**PCI:** PCI Device

#### 10.7.1.10. PEG Port Configuration

**PEG Port:** Available settings are: **Disabled** and **Auto**.

➤ **Video Function Configuration**

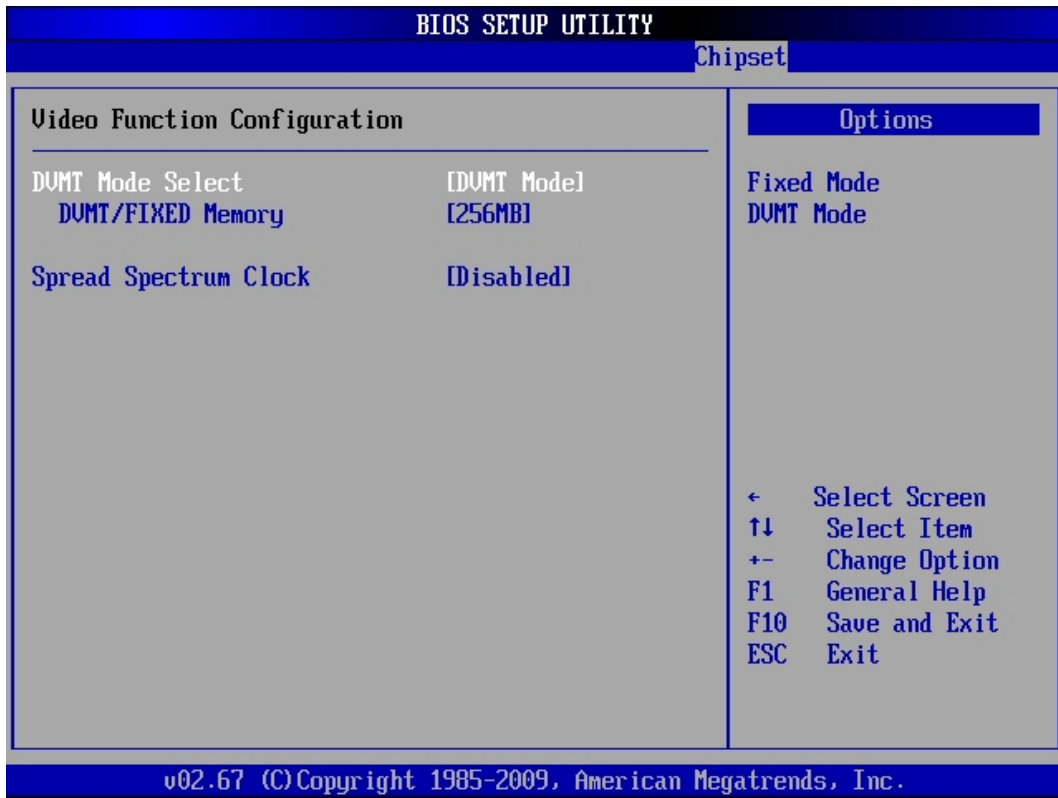

#### 10.7.1.11. DVMT Mode Select

This option allows you to select the DVMT operating mode.

Available settings are: *Fixed Mode* and **DVMT Mode**.

#### 10.7.1.12. DVMT/Fixed Memory

Available settings are: *Maximum DVTM*, *128MB* and **256MB**.

#### 10.7.1.13. Spread Spectrum Clock

Available settings are: *Enabled* and **Disabled**.

## 10.7.2. South Bridge Chipset Configuration

You can use this field to select options for the SouthBridge chipset configuration.

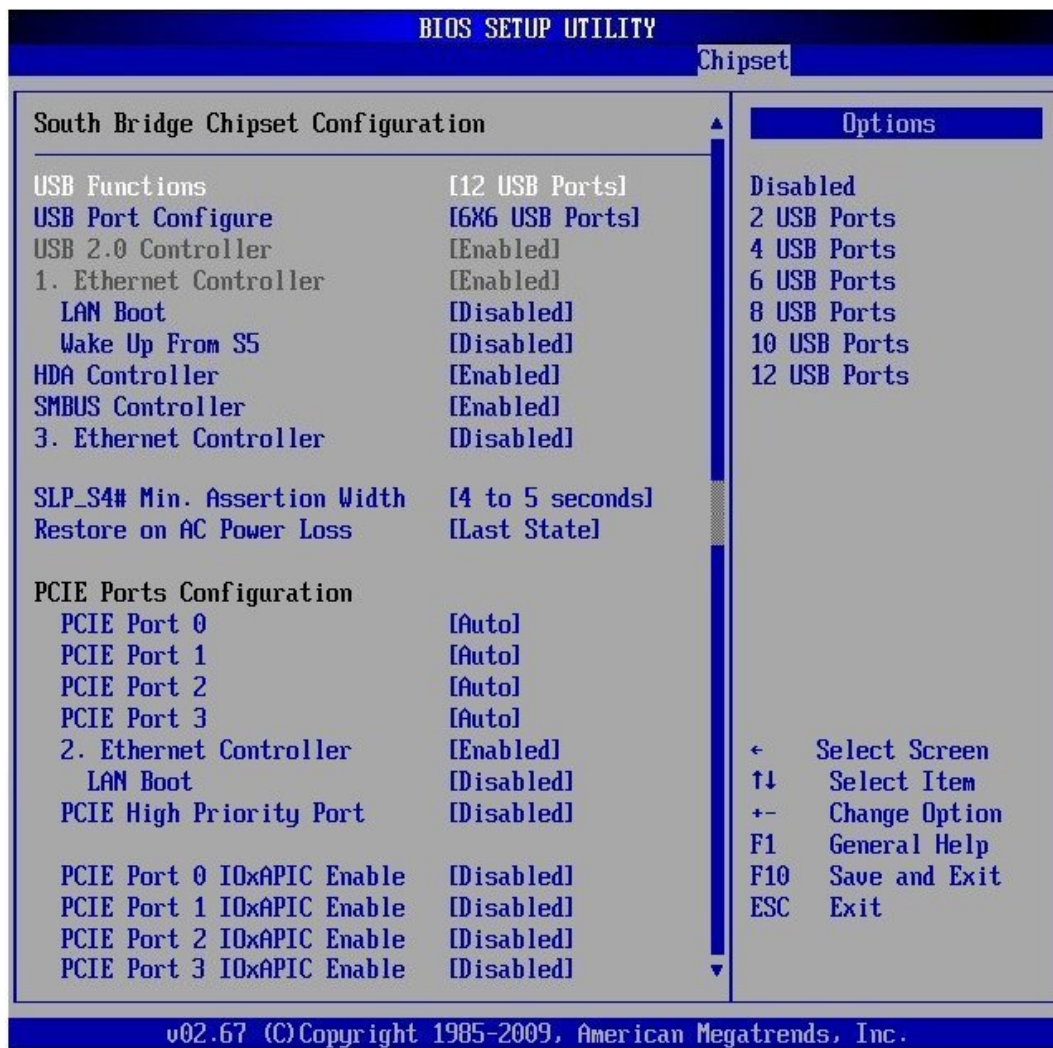

### 10.7.2.1. USB Function

This option allows you to enable or disable the host controllers.

Possible settings are: *Disabled*, *2 USB Ports*, *4 USB Ports*, *6 USB Ports*, *8 USB Ports*, *10 USB Ports* and **12 USB Ports**.

### 10.7.2.2. USB Port Configure

Possible settings are: **6x6 USB Ports** and *8x4 USB Ports*.

### 10.7.2.3. USB 2.0 Controller

This option (EHCI USB controller function) is always enabled.

### 10.7.2.4. 1. / 2. / 3. Ethernet Controller

These options allow you to enable or to disable the corresponding Ethernet controller.

Possible settings are: *Enabled* and *Disabled*.



1. Ethernet Controller is always *Enabled*.
2. Ethernet Controller is set by default to **Enabled**.
3. Ethernet Controller is set by default to **Disabled**.

In order to use the LAN as boot device refer to the chapter 10.5.1.10 "1<sup>st</sup> / 2<sup>nd</sup>, / 3<sup>rd</sup>, .... / n<sup>th</sup> Boot Device"

#### 10.7.2.5. LAN Boot

Possible settings are: *Enabled* and ***Disabled***.



In order to use the LAN as boot device refer to the chapter 10.5.1.10 “1<sup>st</sup> / 2<sup>nd</sup>, / 3<sup>rd</sup>, .... / n<sup>th</sup> Boot Device”

#### 10.7.2.6. Wake Up From S5

Possible settings are: *Enabled* and ***Disabled***.

#### 10.7.2.7. Wake Up From S5

Possible settings are: *Enabled* and ***Disabled***.

#### 10.7.2.8. HDA Controller

This option allows you to enable or disable the HAD audio controller.

Possible settings are: ***Enabled*** and *Disabled*.

#### 10.7.2.9. SMBUS Controller

This option allows you to enable or to disable the SMBUS controller.

Possible settings are: ***Enabled*** and *Disabled*.

#### 10.7.2.10. SLP\_S4# Min Assertion Width

The available settings are: *1 to 2 seconds*, *2 to 3 seconds*, *3 to 4 seconds* and ***4 to 5 seconds***.

#### 10.7.2.11. Restore on AC Power Loss

**10.7.2.12.** This option allows you to specify the state the system should return to when power is restored after AC power loss.

The available settings are: *Power Off*, *Power On* and ***Last State***.

#### 10.7.2.13. PCIE Ports Configuration

#### 10.7.2.14. PCIE Port 0 / PCIE Port 1 / PCIE Port 2 / PCIE Port 3

Possible settings are: ***Auto***, *Enabled* and *Disabled*.

#### 10.7.2.15. PCIE High Priority Port

Available settings are: ***Disabled***, *Port 0*, *Port 1*, *Port 2*, *Port 3*, *2. Ethernet* and *1. Ethernet*.

#### 10.7.2.16. PCIE Port 0 IOxAPIC Enable / PCIE Port 1 IOxAPIC Enable / PCIE Port 2 IOxAPIC Enable / PCIE Port 3 IOxAPIC Enable

Available settings are: ***Disabled*** and *Enabled*.

### 10.7.3. ME Subsystem Configuration

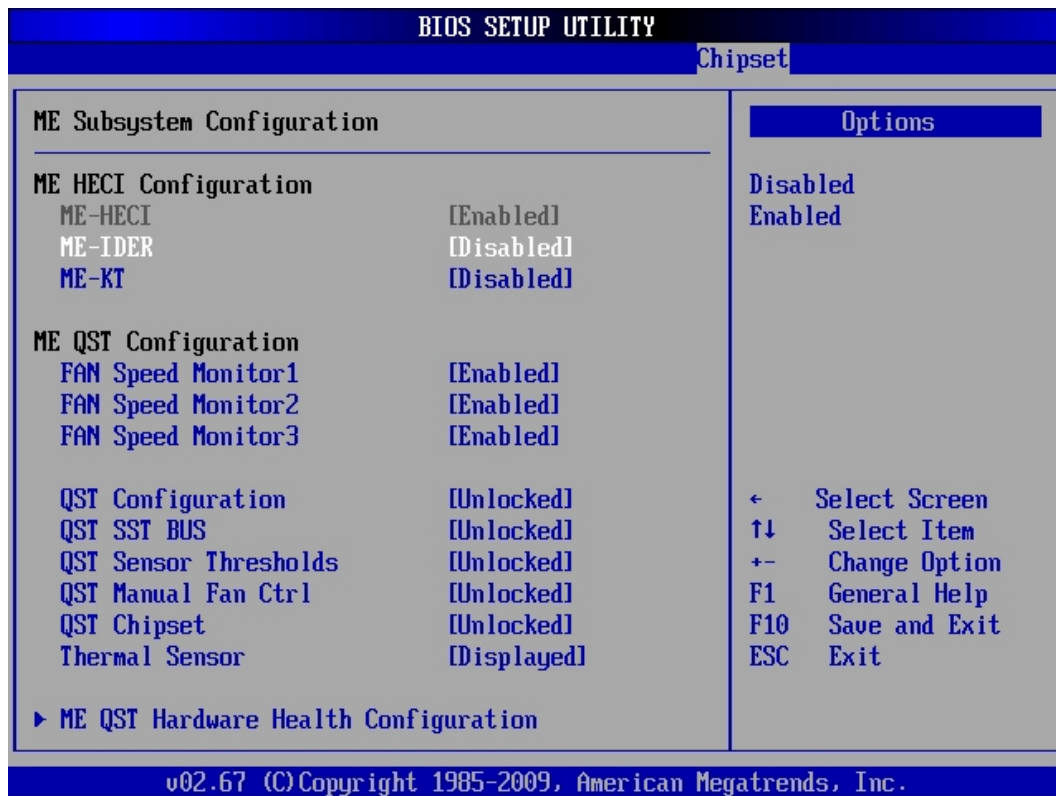

#### 10.7.3.1. ME HECI Configuration

##### ME-HECI

This option is set by default to *Enabled*.

##### ME-IDER/ME-KT

Possible settings are: *Enabled* and ***Disabled***.

#### 10.7.3.2. ME QST Configuration

##### FAN Speed Monitor 1 / 2 / 3

Possible settings are: ***Enabled*** and *Disabled*.

##### QST Configuration

Possible settings are: *Locked* and ***Unlocked***.

##### QST SST BUS

Possible settings are: *Locked* and ***Unlocked***.

##### QST Sensor Thresholds

Possible settings are: *Locked* and ***Unlocked***.

##### QST Manual Fan CTRL

Possible settings are: *Locked* and ***Unlocked***.

##### QST Chipset

Possible settings are: *Locked* and ***Unlocked***.

##### Thermal Sensor

Possible settings are: *Hidden* and ***Displayed***.

## ➤ ME QST Hardware Health Configuration

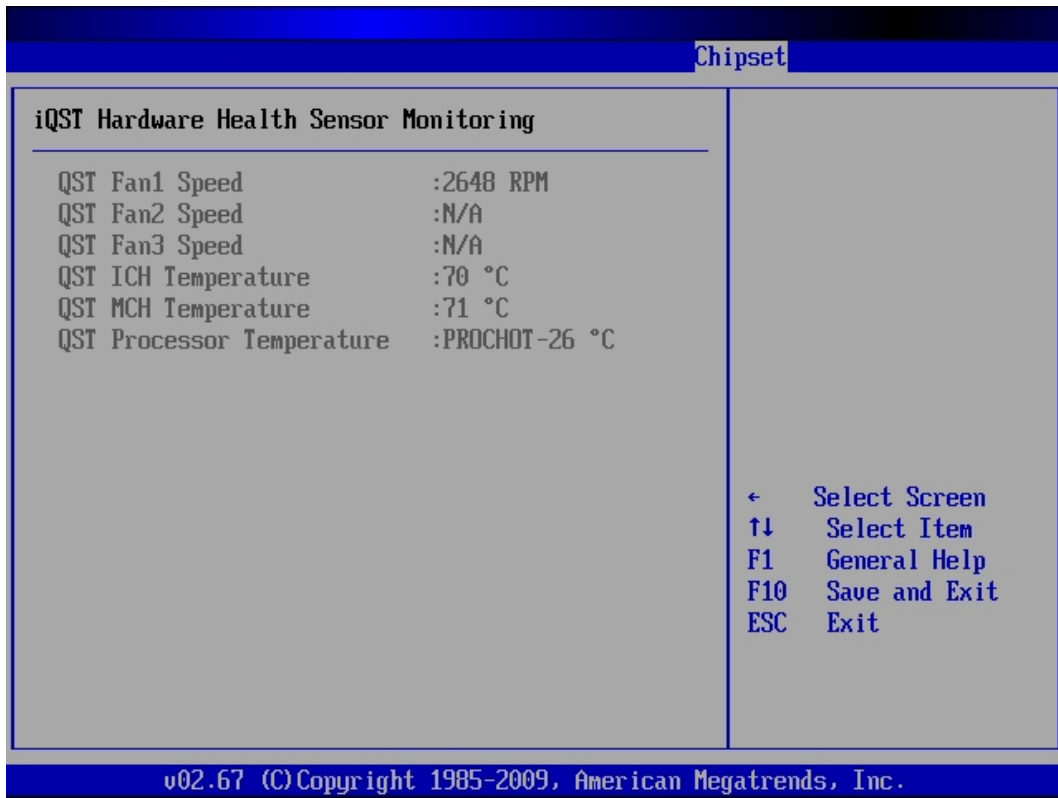



## 10.8. Exit

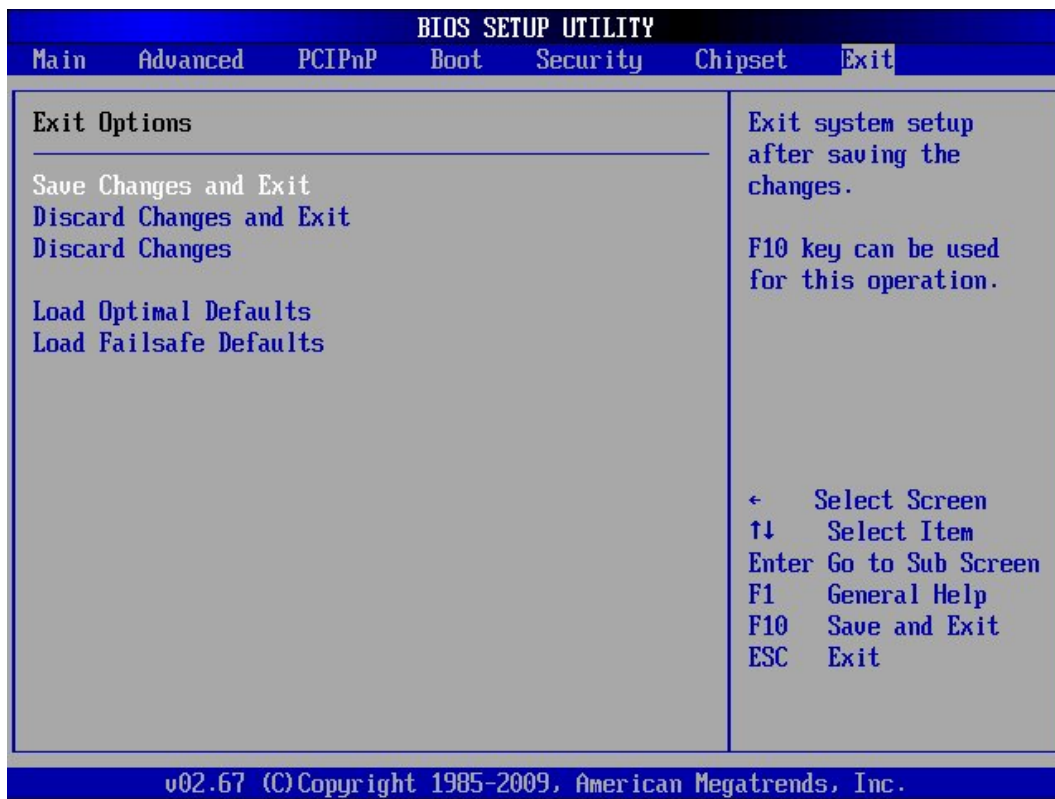

### 10.8.1. Save Changes and Exit

This field saves the settings you have made and exits BIOS Setup.

### 10.8.2. Discard Changes and Exit

This field exits BIOS Setup without saving the new settings.

### 10.8.3. Discard Changes

This field resets all values to those that were active when the computer was turned on without exiting BIOS Setup.

### 10.8.4. Load Optimal Defaults

This option allows you to load the default values of your system configuration. These default settings (manufacturing settings) are optimal and enable all high performance features.

### 10.8.5. Load Failsafe Defaults

By this option the system can reload all default settings, which are permanently stored in the BIOS-ROM.

These settings are not the optimized default settings (manufacturing defaults) for your system, but can be used, if after changes, the system does not run reliably. The Fail-Safe settings are designed for maximum stability, but not maximum performance.

## 11. Technical Data

PCI-760 Board	Main Specifications
<b>Processor</b>	Intel® Core™ 2 Duo/Quad, (Desktop); Socket 775 For CPU frequency, please refer to the actually data sheet on the web page: <a href="http://www.kontron.com">www.kontron.com</a>
<b>Board Type</b>	PICMG 1.3 standard, full size
<b>Memory Socket</b>	4x 240-pin DDR2 DIMMs
<b>Memory</b>	Up to 8GB of 667/800 MHz DDR2 SDRAM (dual channel), unbuffered, non-ECC; Memory Type: 256 Mb, 512Mb, 1Gb
<b>Cache</b>	Up to 4 MB Level 2 depending on the installed processor
<b>Chipset</b>	Intel® 82Q35 GMCH with integrated Intel® GMA 3100 (Graphics Media Accelerator) Intel® ICH9DO with Intel® Matrix Storage Technology for SATA RAID 0, 1, 5, 10 configuration
<b>LPC Super I/O</b>	Winbond W83627HF
<b>Gigabit Ethernet Controllers</b>	1x Intel® 82566DM (ICH9DO) LAN-Controller 1x Realtek RTL8111B LAN Controller 1x Realtek 8110SC LAN Controller
<b>Audio</b>	Integrated HDA ( <b>H</b> igh <b>D</b> efinition <b>A</b> udio) controller (ICH9DO) with ALC882 Codec
<b>BIOS</b>	AMI BIOS PnP; ACPI 3.0; 4MB (32Mbits) Flash BIOS ROM
<b>Watchdog</b>	Time-out occurs after 255 seconds/minutes
<b>Operating Systems</b>	Information about the applicable operating systems refer to the web page: <a href="http://www.kontron.com">www.kontron.com</a> or: <a href="mailto:support@kontron.com">support@kontron.com</a>
<b>External Connectors (on the slot bracket)</b>	1x Ethernet (LAN1) (10/100/1000 Mbps, [Intel® AMT ( <b>A</b> ctive- <b>M</b> anagement- <b>T</b> echnology)]) 1x Ethernet (LAN2) 10/100/1000 Mbps) 2x USB (2.0) 1x VGA
<b>Onboard Connectors</b>	4x SATA II, 3Gbps 1x MiniPCI (Option) 2x Serial Port 1x COM1 (RS232) 1x COM2 (RS232) configurable RS422, RS485 1x Parallel Port 6x USB (2.0) 1x Audio (Line-In, Line-Out, Mic-In) 1x Audio (Surround L/R, Side surround L/R, Center/LFE), 1x SPDIF-In&-Out (supports coax. and optical fibre via additional Multimedia Bracket) 1x Multifunctional Connector with support for: 1x PS/2 Keyboard 1x PS/2 Mouse 1x Power LED 1x Reset Button 1x Speaker 1x HDD LED 1x Hardware Monitor supports monitoring of: 4x Fan-Taacho Power Button Chassis Intruder 1x SMBus 4x user defined GPIO[0-3] 3x 12V Fan Power Connector (4-pin) 1x 12V ATX Power Connector 1x Additional Power Button Connecor 1x Suspend-LED 1x Keyboard&Mouse 1x Keyboard Lock 1x LPC-Bus (reserved) 1x Lithium Battery Socket 1x External Battery Connector 1x Connector for Temp. Sensor (factory-fitted with Temperature Sensor)

The table is continued on the next page.

<b>Onboard Jumpers</b>	2x Configuration COM2 with Termination Resistors 1x Disable CMOS Backup Restore Function 1x RTC Reset (Clear CMOS)
<b>Power Supply</b>	Lithium battery 3.0 V for RTC, Type: CR2032 External 12V ATX: [option: via on-board or backplane] Power via backplane and PICMG 1.3 edge connector: +3.3 VSB, +5.0 VSB, +12.0 V, +5.0 V, +3.3 V

## 11.1. Electrical Specifications

Board Version	Type of the external PSU	Inputs via	
PCI-760	ATX PSU	Backplane and PICMG 1.3 edge connector	+3.3 VSB, +5 VSB, +3.3 V, +5.0 V, +12.0 V
		On-board 12 V ATX power connector: J31 or 12V ATX power connector on the backplane	+12V

## 11.2. Mechanical Specifications

<b>Dimensions</b>	338.58 x 126.39 x 22.7 mm (13.33" x 4.98" x 0.89") (height without CPU heatsink)
<b>Weight</b>	0.455 kg (1.003 lbs.) (without CPU fan)

## 11.3. Environmental Specifications

<b>Operating Temperature</b>	0 °C to 60 °C (32 °F to 140 °F)
<b>Storage/Transport Temperature</b>	-40 °C to +70 °C (-40 °F to 158 °F)
<b>Relative Humidity</b>	5 % to 95 % (non-condensing)

## 11.4. CE Directives

CE Directives	
Electrical Safety	General Product Safety Directive (GPSD) 2001/95/EC Low Voltage Directive (LVD) 2006/95/EC
ElectroMagnetic Compatibility (EMC)	EMC Directive 2004/108/EC

## 12. Technical Support

For technical support, please contact our Technical Support department.

German headquarter Hotline:

TEL: (+49) 8165-77 112

FAX: (+49) 8165-77 110

E-mail: [support@kontron.com](mailto:support@kontron.com)

Make sure you have the following on hand when you call:

- the unit part id number (P/No #),
- and the serial number (S/No #) of the unit (provide the serial number found on the label, placed on the rear side of the board).

Be ready to explain the nature of your problem to the service technician.

If you have any questions about Kontron Embedded Computers or our products and services, you may reach us at the aforementioned numbers, or at: [www.kontron.com](http://www.kontron.com) or by writing to:

Kontron Embedded Computers GmbH

Oskar von Miller-Str. 1

85386 Eching

Germany

### 12.1. Returning Defective Merchandise

Before returning any merchandise please:

Download the form for returning a device with an RMA No. [RMA (Return of Material Authorization)] from our website [www.kontron.com](http://www.kontron.com) / Support /RMA Information; contact our Customer Service department to obtain an RMA No.:

Fax: (+49) 8165-77 412

e-Mail: [service@kontron.com](mailto:service@kontron.com)

4. Ensure that you have received an RMA No. from Kontron Customer Services before returning any device. Write this number clearly on the outside of the package that you are sending to us.
5. Describe the fault that has occurred.
6. Please provide the name and telephone number of a person we can contact to obtain more information, where necessary. Where possible, please enclose all the necessary customs documents and invoices.
7. When returning a device:
  - Pack it securely in its original box.
  - Enclose a copy of the RMA form with the consignment.

### Corporate Offices

Europe, Middle East & Africa	North America	Asia Pacific
Oskar-von-Miller-Str. 1 85386 Eching/Munich Germany Tel.: +49 (0)8165/ 77 777 Fax: +49 (0)8165/ 77 219 <a href="mailto:info@kontron.com">info@kontron.com</a>	14118 Stowe Drive Poway, CA 92064-7147 USA Tel.: +1 888 294 4558 Fax: +1 858 677 0898 <a href="mailto:info@us.kontron.com">info@us.kontron.com</a>	17 Building,Block #1,ABP. 188 Southern West 4th Ring Beijing 100070, P.R.China Tel.: + 86 10 63751188 Fax: + 86 10 83682438 <a href="mailto:info@kontron.cn">info@kontron.cn</a>

