

» Kontron User's Guide «

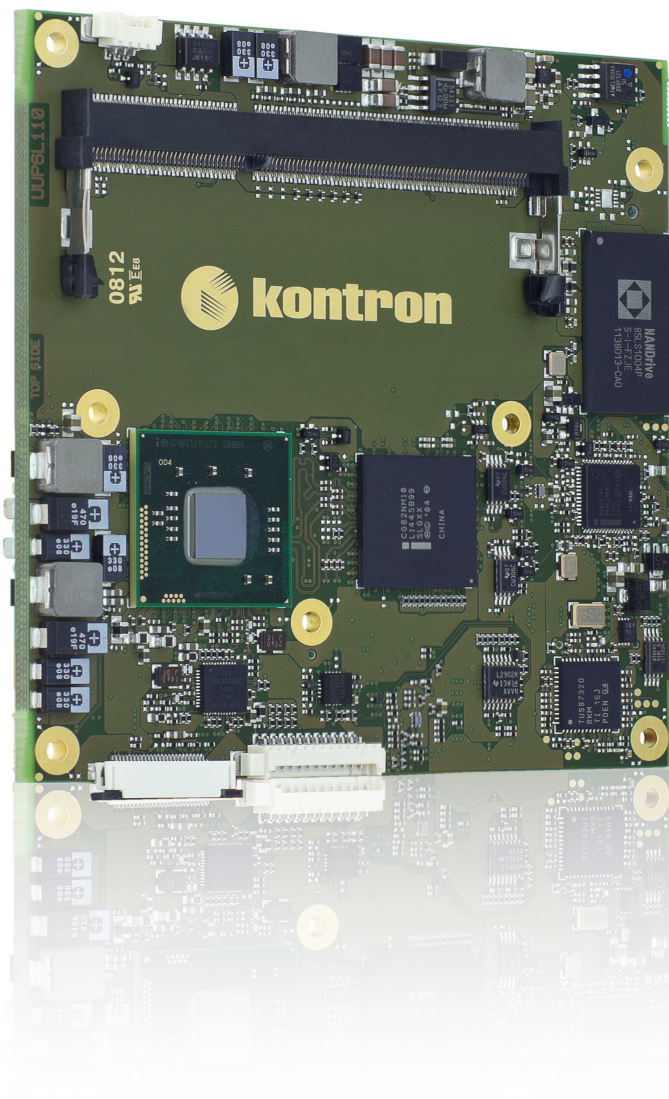

COMe-cCT6

Document Revision 130

» Table of Contents «

1	<u>User Information</u>	6
1.1	<u>About This Document</u>	6
1.2	<u>Copyright Notice</u>	6
1.3	<u>Trademarks</u>	6
1.4	<u>Standards</u>	6
1.5	<u>Warranty</u>	7
1.6	<u>Technical Support</u>	7
2	<u>Introduction</u>	8
2.1	<u>Product Description</u>	8
2.2	<u>Naming clarification</u>	8
2.3	<u>Understanding COM Express® Functionality</u>	8
2.4	<u>COM Express® Documentation</u>	9
2.5	<u>COM Express® Benefits</u>	9
3	<u>Product Specification</u>	10
3.1	<u>Modules definition</u>	10
3.2	<u>Functional Specification</u>	11
3.3	<u>Block Diagram</u>	15
3.4	<u>Accessories</u>	16
3.5	<u>Electrical Specification</u>	17
3.5.1	<u>Supply Voltage</u>	17
3.5.2	<u>Power Supply Rise Time</u>	17
3.5.3	<u>Supply Voltage Ripple</u>	17
3.5.4	<u>Power Consumption</u>	17
3.5.5	<u>ATX Mode</u>	18
3.5.6	<u>Single Supply Mode</u>	18
3.6	<u>Power Control</u>	19
3.7	<u>Environmental Specification</u>	20
3.7.1	<u>Temperature Specification</u>	20
3.7.2	<u>Humidity</u>	20
3.8	<u>Standards and Certifications</u>	21
3.9	<u>MTBF</u>	23
3.10	<u>Mechanical Specification</u>	24
3.11	<u>Module Dimensions</u>	25
3.12	<u>Thermal Management, Heatspreader and Cooling Solutions</u>	26
3.13	<u>Onboard Connectors</u>	27
3.13.1	<u>FAN</u>	28
3.13.2	<u>CPU Debug & CPLD</u>	28
4	<u>Features and Interfaces</u>	29
4.1	<u>Onboard SSD</u>	29
4.2	<u>S5 Eco Mode</u>	30

4.3	LPC	31
4.4	Serial Peripheral Interface (SPI)	32
4.5	SPI boot	32
4.6	M.A.R.S.	34
4.7	UART	35
4.8	Fast I2C	36
4.9	GPIO - General Purpose Input and Output	37
4.10	Dual Staged Watchdog Timer	38
4.11	Intel® Fast Flash Standby™ / Rapid Start Technology™	39
4.12	Speedstep Technology	41
4.13	C-States	42
4.14	Hyper Threading	43
4.15	Display Configuration	44
4.16	Graphics Features	47
4.17	Hardware Configuration	47
4.18	Graphics VBIOS and Driver	47
4.19	ACPI Suspend Modes and Resume Events	48
4.20	USB	49
5	System Resources.....	50
5.1	Interrupt Request (IRQ) Lines	50
5.2	Memory Area	50
5.3	I/O Address Map	51
5.4	Peripheral Component Interconnect (PCI) Devices	51
5.5	I2C Bus	52
5.6	JILI I2C Bus	52
5.7	System Management (SM) Bus	52
6	Connectors.....	53
6.1	Connector Location	53
7	Pinout List.....	54
7.1	General Signal Description	54
7.2	Connector X1A Row A	55
7.3	Connector X1A Row B	57
7.4	Connector X1B Row C	59
7.5	Connector X1B Row D	61
8	BIOS Operation.....	63
8.1	Determining the BIOS Version	63
8.2	BIOS Update	63
8.3	Setup Guide	65
8.4	POST Codes	65
8.4.1	Start AMI® Aptio Setup Utility	65

8.5	BIOS Setup	67
8.5.1	Main Menu	67
8.5.2	Advanced	69
8.5.3	Chipset	99
8.5.4	Boot	106
8.5.5	Security	107
8.5.6	Save & Exit	109

1 User Information

1.1 About This Document

This document provides information about products from Kontron Europe GmbH and/or its subsidiaries. No warranty of suitability, purpose, or fitness is implied. While every attempt has been made to ensure that the information in this document is accurate, the information contained within is supplied "as-is" and is subject to change without notice.

For the circuits, descriptions and tables indicated, Kontron assumes no responsibility as far as patents or other rights of third parties are concerned.

1.2 Copyright Notice

Copyright © 2003-2014 Kontron Europe GmbH

All rights reserved. No part of this document may be reproduced, transmitted, transcribed, stored in a retrieval system, or translated into any language or computer language, in any form or by any means (electronic, mechanical, photocopying, recording, or otherwise), without the express written permission of Kontron Europe GmbH.

DIMM-PC®, PISA®, ETX®, ETXexpress®, microETXexpress®, X-board®, DIMM-IO® and DIMM-BUS® are trademarks or registered trademarks of Kontron Europe GmbH. Kontron is trademark or registered trademark of Kontron AG.

1.3 Trademarks

The following lists the trademarks of components used in this board.

- » IBM, XT, AT, PS/2 and Personal System/2 are trademarks of International Business Machines Corp.
- » Microsoft is a registered trademark of Microsoft Corp.
- » Intel is a registered trademark of Intel Corp.
- » All other products and trademarks mentioned in this manual are trademarks of their respective owners.

1.4 Standards

Kontron Europe GmbH is certified to ISO 9000 standards.

1.5 Warranty

For this Kontron Europe GmbH product warranty for defects in material and workmanship exists as long as the warranty period, beginning with the date of shipment, lasts. During the warranty period, Kontron Europe GmbH will decide on its discretion if defective products are to be repaired or replaced.

Within the warranty period, the repair of products is free of charge as long as warranty conditions are observed.

Warranty does not apply for defects arising/resulting from improper or inadequate maintenance or handling by the buyer, unauthorized modification or misuse, as well as the operation outside of the product's environmental specifications and improper installation and maintenance.

Kontron Europe GmbH will not be responsible for any defects or damages to other products not supplied by Kontron Europe GmbH that are caused by a faulty Kontron Europe GmbH product.

1.6 Technical Support

Technicians and engineers from Kontron Europe GmbH and/or its subsidiaries are available for technical support. We are committed to make our product easy to use and will help you use our products in your systems.

Please consult our Website at <http://www.kontron.com/support> for the latest product documentation, utilities, drivers and support contacts. Consult our customer section <http://emdcustomersection.kontron.com> for the latest BIOS downloads, Product Change Notifications, Board Support Packages, DemoImages, 3D drawings and additional tools and software. In any case you can always contact your board supplier for technical support.

2 Introduction

2.1 Product Description

COMe-cCT6 is the energy efficient entry-level multicore module based on next-generation Intel® Atom™ processors with 32 nm technology. The module is available in three multicore performance levels up to 2x 1.86 GHz and offers an increased performance per watt ratio and offers twice the graphics capability. The COM Express® pin-out type 6 definition enables the module to provide these increased capabilities via a scalable interface range that offers suitable options for both cost and power sensitive applications alike.

2.2 Naming clarification

COM Express® defines a Computer-On-Module, or COM, with all components necessary for a bootable host computer, packaged as a super component.

- » COMe-bXX# modules are Kontron's COM Express® modules in basic form factor (125mm x 95mm)
- » COMe-cXX# modules are Kontron's COM Express® modules in compact form factor (95mm x 95mm)
- » COMe-mXX# modules are Kontron's COM Express® modules in mini form factor (55mm x 84mm)

The product names for Kontron COM Express® Computer-on-Modules consist of a short form of the industry standard (**COMe-**), the form factor (**b**=basic, **c**=compact, **m**=mini), the capital letters for the CPU and Chipset Codenames (**XX**) and the pin-out type (**#**) followed by the CPU Name.

2.3 Understanding COM Express® Functionality

All Kontron COM Express® basic and compact modules contain two 220pin connectors; each of it has two rows called Row A & B on primary connector and Row C & D on secondary connector. COM Express® Computer-on-modules feature the following maximum amount of interfaces according to the PICMG module Pin-out type:

Feature	Pin-Out Type 1	Pin-Out Type 10	Pin-Out Type 2	Pin-Out Type 6
HD Audio	1x	1x	1x	1x
Gbit Ethernet	1x	1x	1x	1x
Serial ATA	4x	4x	4x	4x
Parallel ATA	-	-	1x	-
PCI	-	-	1x	-
PCI Express x1	6x	6x	6x	8x
PCI Express x16 (PEG)	-	-	1x	1x
USB Client	1x	1x	-	-
USB 2.0	8x	8x	8x	8x
USB 3.0	-	2x	-	4x
VGA	1x	-	1x	1x
LVDS	Dual Channel	Single Channel	Dual Channel	Dual Channel
DP++ (SDVO/DP/HDMI/DVI)	1x optional	1x	3x shared with PEG	3x
LPC	1x	1x	1x	1x
External SMB	1x	1x	1x	1x
External I2C	1x	1x	1x	1x
GPIO	8x	8x	8x	8x
SDIO shared w/GPIO	1x optional	1x optional	-	1x optional
UART (2-wire COM)	-	2x	-	2x
FAN PWM out	-	1x	-	1x

2.4 COM Express® Documentation

This product manual serves as one of three principal references for a COM Express® design. It documents the specifications and features of COMe-cCT6. Additional references are available at your Kontron Support or at PICMG®:

- » The COM Express® Specification defines the COM Express® module form factor, pin-out, and signals. This document is available at the PICMG® website by filling out the order form.
- » The COM Express® Design Guide by PICMG® serves as a general guide for baseboard design, with a focus on maximum flexibility to accommodate a wide range of COM Express® modules.



Some of the information contained within this product manual applies only to certain product revisions (CE: xxx). If certain information applies to specific product revisions (CE: xxx) it will be stated. Please check the product revision of your module to see if this information is applicable.

2.5 COM Express® Benefits

COM Express® modules are very compact, highly integrated computers. All Kontron COM Express® modules feature a standardized form factor and a standardized connector layout which carry a specified set of signals. Each COM is based on the COM Express® specification. This standardization allows designers to create a single-system baseboard that can accept present and future COM Express® modules.

The baseboard designer can optimize exactly how each of these functions implements physically. Designers can place connectors precisely where needed for the application on a baseboard designed to optimally fit a system's packaging.

A single baseboard design can use a range of COM Express® modules with different sizes and pin-outs. This flexibility can differentiate products at various price/performance points, or when designing future proof systems that have a built-in upgrade path. The modularity of a COM Express® solution also ensures against obsolescence when computer technology evolves. A properly designed COM Express® baseboard can work with several successive generations of COM Express® modules.

A COM Express® baseboard design has many advantages of a customized computer-board design and, additionally, delivers better obsolescence protection, heavily reduced engineering effort, and faster time to market.

3 Product Specification

3.1 Modules definition

The COM Express® compact sized Computer-on-Module COMe-cT6 (UUP6) follows pin-out Type 6 and is compatible to PICMG specification COM.0 Rev 2.1. The COMe-cT6, based on Intel's Cedar Trail platform, is available in different variants to cover the demand of different performance, price and power:

Commercial grade modules (0°C to 60°C operating)

Product Number	Product Name	Processor	UART	Flash	USB 3.0	TPM
36011-0040-19-7	COMe-cT6 D2550	Cedarview-D Intel® Atom™ D2550	2x	4GB SLC	2x	Yes
36011-0000-19-6	COMe-cT6 D2550	Cedarview-D Intel® Atom™ D2550	-	-	-	-
36011-0000-19-2	COMe-cT6 N2800	Cedarview-M Intel® Atom™ N2800	-	-	-	-
36011-0000-16-3	COMe-cT6 N2600 SER	Cedarview-M Intel® Atom™ N2600	2x	-	-	-
36011-0000-16-2	COMe-cT6 N2600	Cedarview-M Intel® Atom™ N2600	-	-	-	-

Optional hardware features:

- » TPM
- » PCI Express USB 3.0 (xHCI) controller TI
- » 2x UART
- » 2 to 32GB SLC NANDrive
- » 2 to 64GB MLC NANDrive

Optional BIOS features:

- » Secure Flash Update
- » Secure Boot
- » CSM OptOut

Extended temperature grade modules (E1, -25°C to 75°C operating)

Product Number	Product Name	Processor	UART	Flash	USB 3.0	TPM
36011-0000-19-6EXT	COMe-cT6 D2550 E1	Cedarview-D Intel® Atom™ D2550	-	-	-	-
36011-0000-19-2EXT	COMe-cT6 N2800 E1	Cedarview-M Intel® Atom™ N2800	-	-	-	-
36011-0000-16-2EXT	COMe-cT6 N2600 E1	Cedarview-M Intel® Atom™ N2600	-	-	-	-

Optional hardware features:

- » PCI Express USB 3.0 (xHCI) controller TI
- » 2x UART
- » 2 to 32GB SLC NANDrive
- » 2 to 64GB MLC NANDrive (industrial grade versions only)

Industrial temperature grade modules (XT, -40°C to 85°C operating)

Modules for E2 temperature range are available by screening on project base, please contact your local sales or support for further details.

Part Number	Product Name	Processor	UART	Flash	USB 3.0	TPM
36011-00FF-CC-x	COMe-cT6 XT	All	optional	optional	n/a	n/a



Optional hardware and BIOS features are available project based only for variants not listed above. Please contact your local sales for customized articles.

3.2 Functional Specification

Processor

The 32nm Intel® Atom™ D2000/N2000 (Cedarview-M/D) CPU family supports:

- » Intel® Hyper-Threading Technology
- » Intel® 64
- » Enhanced Intel SpeedStep® Technology (N2xxx only)
- » Thermal Monitoring Technologies
- » Execute Disable Bit
- » 2 Display Pipes for dual independent displays

CPU specifications

CPU	Intel® Atom™ D2550	Intel® Atom™ N2800	Intel® Atom™ N2600
Cores	2	2	2
Threads	4	4	4
Clock	1866MHz	1866MHz	1600MHz
Memory Speed	DDR3-1066	DDR3-1066	DDR3-800
Max Memory	up to 4GB	up to 4GB	up to 2GB
Cache	1MB	1MB	1MB
C-States	C0/C1	C0-C6 / C1E-C4E	C0-C6 / C1E-C4E
EIST	-	YES	YES
CPU Thermal Management	TM1	TM1 & TM2	TM1 & TM2
GFX	GMA3650	GMA3650	GMA3600
GFX core frequency	640MHz	640MHz	400MHz
GFX render clock frequency	200MHz	200MHz	200MHz
Display Core Clock	355MHz	267MHz	200MHz
LVDS	1x18/24bit	1x18/24bit	1x18/24bit
LVDS Resolution	up to 1440x900x60	up to 1366x768x60	up to 1366x768x60
eDP Resolution	up to 1920x1080x60	up to 1366x768x60	up to 1366x768x60
DP Resolution	up to 2560x1600x60	up to 1600x1200x60	up to 1600x1200x60
HDMI/DVI Resolution	up to 1920x1200x60	up to 1920x1200x60	up to 1920x1200x60
VGA Resolution	up to 1920x1200x60	up to 1920x1200x60	up to 1920x1200x60
PAVP	1.1c	1.1c	-
HDCP	1.3	1.3	-
Blu-Ray 2.0 Playback	Yes	Yes	-
TDP	10W	6.5W	3.5W

Memory

Sockets	1x DDR3 SO-DIMM
Memory Type	DDR3-800 / 1066
Maximum Size	1x4GB, 4GB supported by 256Mx16 configuration only
Technology	Single Channel (64bit)

Graphics Core

The integrated SGX545 core based Intel® GMA 3650 / 3600 supports:

Graphics Core Render Clock	640MHz @ GMA3650 (D2700/N2800) 400MHz @ GMA3600 (N2600),
Execution Units / Pixel Pipelines	4
Max Graphics Memory	1024MB
GFX Memory Bandwidth (GB/s)	6.4 / 8.5
GFX Memory Technology	DVMT
API (DirectX/OpenGL)	9.0c / 3.0
Shader Model	3.0
Hardware accelerated Video	H.264, MPEG2, VC1, Blu-ray
Independent/Simultaneous Displays	2
Display Port	DP / eDP 1.1
HDCP support	HDCP 1.3a / PAVP 1.1c

Monitor output

CRT max Resolution	1920x1200
TV out:	-

LVDS

LVDS Bits/Pixel	1x18 / 1x24
LVDS Bits/Pixel with dithering	-
LVDS max Resolution:	D: 1440x900, M: 1366x768, 112MHz
PWM Backlight Control:	YES
Supported Panel Data:	JIL12/JIL13/EDID/DID

Display Interfaces

Discrete Graphics	-
Digital Display Interface DDI1	DP++
Digital Display Interface DDI2	DP++
Digital Display Interface DDI3	-
Maximum Resolution on DDI	HDMI: 1920x1200, DP-D: 2560x1600/DP-M: 1600x1200

PCH: Intel® NM10 Express Chipset

The 130nm Intel Platform Controller Hub Tigerpoint supports:

- » PCI Express Gen 1.0 Speed
- » USB 2.0
- » HD Audio
- » SATA 3Gb/s

Storage

onboard SSD	2-32GB SLC, 2-64GB MLC (SATA)
SD Card support	-
IDE Interface	-
Serial-ATA	up to 2x SATA 3Gb/s
SATA AHCI	AHCI 1.0 with NCQ and HotPlug
SATA RAID	-



With onboard SATA drive only 1 external SATA interface (SATA 0) is available

Connectivity

USB	8x USB 2.0
USB Client	-
PCI	-
PCI External Masters	-
PCI Express	3x PCIe x1 Gen1
Max PCI Express	4x PCIe x1 without LAN
PCI Express x2/x4 configuration	YES
Ethernet	10/100/1000 Mbit
Ethernet controller	Intel® 82574L (Hartwell)



Any PCIe device connecting to Intel® Atom Processor D2000 and N2000 based platform must support No_Snoop attribute

Ethernet

The Intel® 82574L (Hartwell) ethernet supports:

- » Jumbo Frames
- » Time Sync Protocol Indicator
- » WOL (Wake On LAN)
- » PXE (Preboot eXecution Environment)

Misc Interfaces and Features

Supported BIOS Size/Type	4MB SPI
Audio	HD Audio
Onboard Hardware Monitor	Nuvoton NCT7802Y
Trusted Platform Module	Infineon SLB9635TT optional
Miscellaneous	2x UART optional / PWM FAN

Kontron Features

External I2C Bus	Fast I2C, MultiMaster capable
M.A.R.S. support	YES
Embedded API	KEAPI2
Custom BIOS Settings / Flash Backup	YES
Watchdog support	Dual Staged

Additional features

- » All solid capacitors (POSCAP). No tantalum capacitors used.
- » Optimized RTC Battery monitoring to secure highest longevity
- » Real fast I2C with transfer rates up to 40kB/s.
- » Discharge logic on all onboard voltages for highest reliability

Power Features

Singly Supply Support	YES
Supply Voltage	4.75 - 20V
ACPI	ACPI 3.0
S-States	S0, S3, S4, S5
S5 Eco Mode	YES
Misc Power Management	DPST 4.0, iFFS

Power Consumption and Performance

Full Load Power Consumption	7.5 - 13W
Kontron Performance Index	7238 - 9277
Kontron Performance/Watt	736 - 957

 Detailed Power Consumption measurements in all states and benchmarks for CPU, Graphics and Memory performance are available in Application Note [KEMAP054](#) at [EMD Customer Section](#).

3.3 Block Diagram

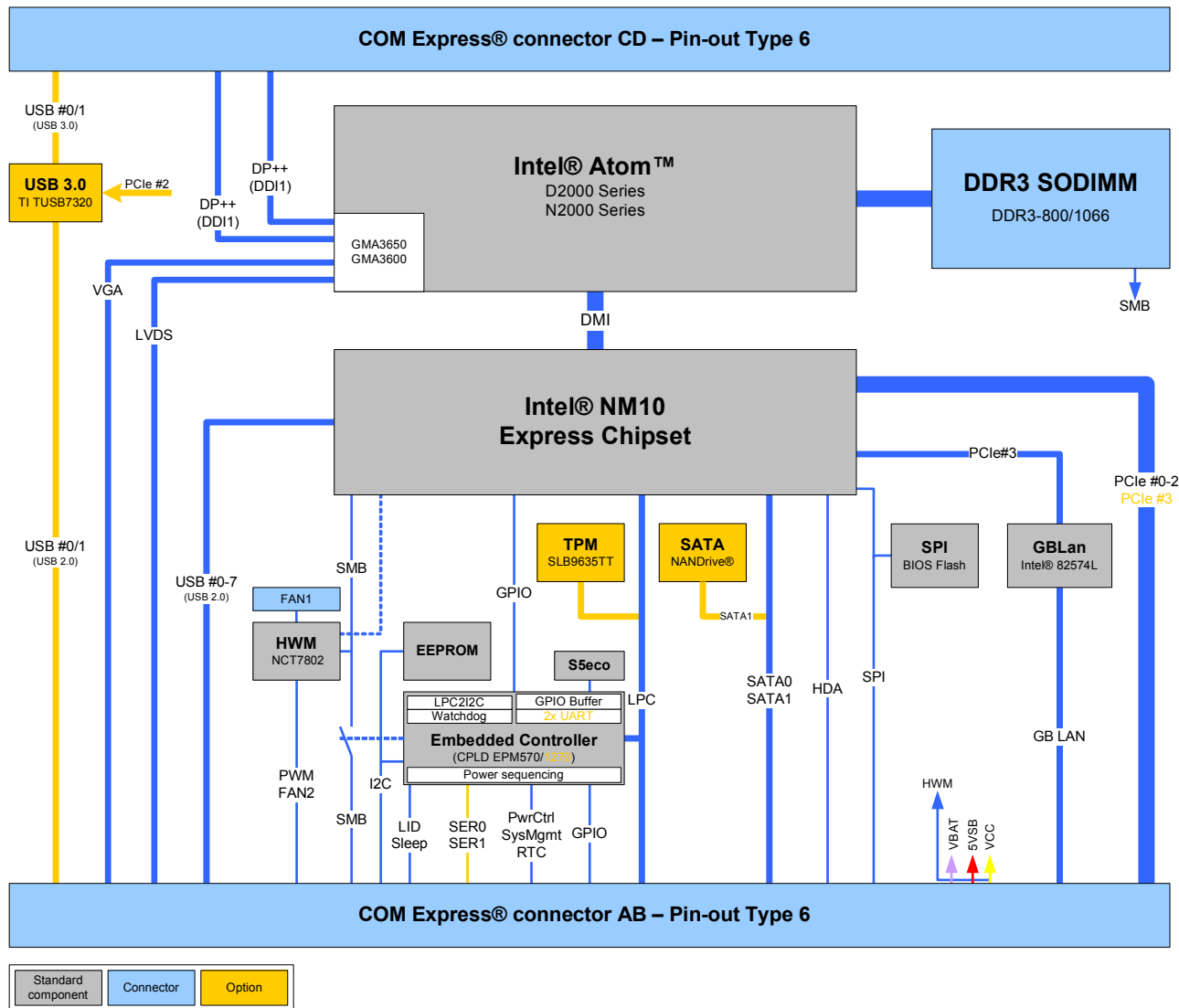

3.4 Accessories

Product specific accessories

Product Number	Heatspreader and Cooling Solutions	Comment
36011-0000-99-0	HSP COMe-cCT6 thread	-
36011-0000-99-1	HSP COMe-cCT6 through	-

General accessories

Part Number	COMe pin-out Type 6 compatible accessories	Project Code	Comment
38114-0000-00-0	COM Express® Reference Carrier Type 6	ADAS	mITX Carrier with 8mm COMe connector
38106-0000-00-0	COM Express® Eval Carrier Type 6	Topanga Canyon	ATX Carrier with 5mm COMe connector
96007-0000-00-3	ADA-PCIe-DP	APDP	PCIe x16 to DP Adapter for Evaluation Carrier
96007-0000-00-7	ADA-Type6-DP3	DVO6	(sandwich) Adapter Card for 3x DisplayPort
96006-0000-00-2	COMe POST T6	NFCB	POST Code / Debug Card
38019-0000-00-0	ADA-COMe-Height-dual	EERC	Height Adapter
38106-0000-00-5	COMe Eval Starterkit T6	Topanga Canyon	Starterkit with COMe Evaluation Carrier T6
38114-0000-00-5	COMe Ref. Starterkit T6	ADAS	Starterkit with COMe Reference Carrier T6
Part Number	Mounting	Comment	
38017-0000-00-5	COMe Mount KIT 5mm 1set	Mounting Kit for 1 module including screws for 5mm connectors	
38017-0100-00-5	COMe Mount KIT 5mm 100sets	Mounting Kit for 100 modules including screws for 5mm connectors	
38017-0000-00-0	COMe Mount KIT 8mm 1set	Mounting Kit for 1 module including screws for 8mm connectors	
38017-0100-00-0	COMe Mount Kit 8mm 100sets	Mounting Kit for 100 modules including screws for 8mm connectors	
Part Number	Cooling Solutions	Comment	
36099-0000-99-0	COMe Active Uni Cooler	for CPUs up to 20W TDP, to be mounted on HSP	
36099-0000-99-1	COMe Passive Uni Cooler	for CPUs up to 10W TDP, to be mounted on HSP	
Part Number	Display Adapter	Comment	
9-5000-0352	ADA-LVDS-DVI 18bit	LVDS to DVI converter	
9-5000-0353	ADA-LVDS-DVI 24bit	LVDS to DVI converter	
96006-0000-00-8	ADA-DP-LVDS	DP to LVDS adapter	
96082-0000-00-0	KAB-ADAPT-DP-DVI	DP to DVI adapter cable	
96083-0000-00-0	KAB-ADAPT-DP-VGA	DP to VGA adapter cable	
96084-0000-00-0	KAB-ADAPT-DP-HDMI	DP to HDMI adapter cable	
Part Number	Cables	Comment	
96079-0000-00-0	KAB-HSP 200mm	Cable adapter to connect FAN to module (COMe basic/compact)	
96079-0000-00-2	KAB-HSP 40mm	Cable adapter to connect FAN to module (COMe basic/compact)	
Part Number	Miscellaneous	Comment	
18029-0000-00-0	MARS Smart Battery Kit	Starterkit Kontron Mobile Application platform for Rechargeable Systems	

Compatible Memory

Product Number	Memory
97015-1024-16-0	DDR3-1600 SODIMM 1GB
97015-2048-16-0	DDR3-1600 SODIMM 2GB
97015-4096-16-0	DDR3-1600 SODIMM 4GB
97015-1024-16-2	DDR3-1600 SODIMM 1GB E2
97015-2048-16-2	DDR3-1600 SODIMM 2GB E2
97015-4096-16-2	DDR3-1600 SODIMM 4GB E2

3.5 Electrical Specification

3.5.1 Supply Voltage

Following supply voltage is specified at the COM Express® connector:

VCC:	4.75 - 20V
Standby:	5V DC +/- 5%
RTC:	2.5V - 3.47V



- 5V Standby voltage is not mandatory for operation.
- Extended Temperature (E1) variants are validated for 12V supply only

3.5.2 Power Supply Rise Time

- » The input voltages shall rise from $\leq 10\%$ of nominal to within the regulation ranges within 0.1ms to 20ms.
- » There must be a smooth and continuous ramp of each DC input voltage from 10% to 90% of its final set-point following the ATX specification

3.5.3 Supply Voltage Ripple

- » Maximum 100 mV peak to peak 0 – 20 MHz

3.5.4 Power Consumption

The maximum Power Consumption of the different COMe-cCT6 variants is 7.5 - 13W (100% CPU load on all cores; 90°C CPU temperature). Further information with detailed measurements are available in Application Note KEMAP054 available on [EMD Customer Section](#). Information there is available after registration.

3.5.5 ATX Mode

By connecting an ATX power supply with VCC and 5VSB, PWR_OK is set to low level and VCC is off. Press the Power Button to enable the ATX PSU setting PWR_OK to high level and powering on VCC. The ATX PSU is controlled by the PS_ON# signal which is generated by SUS_S3# via inversion. VCC can be 4.75 - 20V in ATX Mode. On Computer-on-Modules supporting a wide range input down to 4.75V the input voltage shall always be higher than 5V Standby (VCC > 5VSB).

State	PWRBTN#	PWR_OK	V5_StdBy	PS_ON#	VCC
G3	x	x	0V	x	0V
S5	high	low	5V	high	0V
S5 → S0	PWRBTN Event	low → high	5V	high → low	0 V → VCC
S0	high	high	5V	low	VCC

3.5.6 Single Supply Mode

In single supply mode (or automatic power on after power loss) without 5V Standby the module will start automatically when VCC power is connected and Power Good input is open or at high level (internal PU to 3.3V). PS_ON# is not used in this mode and VCC can be 4.75 - 20V.

To power on the module from S5 state press the power button or reconnect VCC. Suspend/Standby States are not supported in Single Supply Mode.

State	PWRBTN#	PWR_OK	V5_StdBy	VCC
G3	x	x	x	0
G3 → S0	high	open / high	x	connecting VCC
S5	high	open / high	x	VCC
S5 → S0	PWRBTN Event	open / high	x	reconnecting VCC



Signals marked with “x” are not important for the specific power state. There is no difference if connected or open.

All ground pins have to be tied to the ground plane of the carrier board.

3.6 Power Control

Power Supply

The COMe-cCT6 supports a power input from 4.75 - 20V. The supply voltage is applied through the VCC pins (VCC) of the module connector.

Power Button (PWRBTN#)

The power button (Pin B12) is available through the module connector described in the pinout list. To start the module via Power Button the PWRBTN# signal must be at least 50ms ($50\text{ms} \leq t < 4\text{s}$, typical 400ms) at low level (Power Button Event).

Pressing the power button for at least 4seconds will turn off power to the module (Power Button Override).

Power Good (PWR_OK)

The COMe-cCT6 provides an external input for a power-good signal (Pin B24). The implementation of this subsystem complies with the COM Express® Specification. PWR_OK is internally pulled up to 3.3V and must be high level to power on the module.

Reset Button (SYS_RESET#)

The reset button (Pin B49) is available through the module connector described in the pinout list. The module will stay in reset as long as SYS_RESET# is grounded. If available, the BIOS setting for "Reset Behavior" must be set to "Power Cycle".



Modules with Intel® Chipset and active Management Engine do not allow to hold the module in Reset out of S0 for a long time. At about 10s holding the reset button the ME will reboot the module automatically

SM-Bus Alert (SMB_ALERT#)

With an external battery manager present and SMB_ALERT# (Pin B15) connected the module always powers on even if BIOS switch "After Power Fail" is set to "Stay Off".

3.7 Environmental Specification

3.7.1 Temperature Specification

Kontron defines following temperature grades for Computer-on-Modules in general. Please see chapter 'Product Specification' for available temperature grades for the COMe-cCT6

Temperature Specification	Operating	Non-operating	Validated Input Voltage
Commercial grade	0°C to +60°C	-30°C to +85°C	VCC: 4.75 - 20V
Extended Temperature (E1)	-25°C to +75°C	-30°C to +85°C	VCC: 12V
Industrial grade by Screening (XT)	-40°C to +85°C	-40°C to +85°C	VCC: 12V
Industrial grade by Design (E2)	-40°C to +85°C	-40°C to +85°C	VCC: 4.75 - 20V

Operating with Kontron heatspreader plate assembly

The operating temperature defines two requirements:

- » the maximum ambient temperature with ambient being the air surrounding the module.
- » the maximum measurable temperature on any spot on the heatspreader's surface

Test specification:

Temperature Grade	Validation requirements
Commercial grade	at 60°C HSP temperature the CPU @ 100% load needs to run at nominal frequency
Extended Temperature (E1)	at 75°C HSP temperature the CPU @ 75% load is allowed to start speedstepping for thermal protection
Industrial grade by Screening (XT)	at 85°C HSP temperature the CPU @ 50% load is allowed to start throttling for thermal protection
Industrial grade by Design (E2)	at 85°C HSP temperature the CPU @ 50% load is allowed to start throttling for thermal protection

Operating without Kontron heatspreader plate assembly

The operating temperature is the maximum measurable temperature on any spot on the module's surface.

3.7.2 Humidity

- » 93% relative Humidity at 40°C, non-condensing (according to IEC 60068-2-78)

3.8 Standards and Certifications

RoHS II

The **COMe-cCT6** is compliant to the directive 2011/65/EU on the Restriction of the use of certain Hazardous Substances (RoHS II) in electrical and electronic equipment



Component Recognition UL 60950-1

The **COM Express® compact** form factor Computer-on-Modules are Recognized by Underwriters Laboratories Inc. Representative samples of this component have been evaluated by UL and meet applicable UL requirements.

UL Listings:

» [NWGQ2.E304278](#)

» [NWGQ8.E304278](#)



WEEE Directive

WEEE Directive 2002/96/EC is not applicable for Computer-on-Modules.

Conformal Coating

Conformal Coating is available for Kontron Computer-on-Modules and for validated SO-DIMM memory modules. Please contact your local sales or support for further details.

Shock & Vibration

The **COM Express® compact** form factor Computer-on-Modules successfully passed shock and vibration tests according to

- » IEC/EN 60068-2-6 (Non operating Vibration, sinusoidal, 10Hz-4000Hz, +/-0.15mm, 2g)
- » IEC/EN 60068-2-27 (Non operating Shock Test, half-sinusoidal, 11ms, 15g)

EMC

Validated in Kontron reference housing for EMC the **COMe-cCT6** follows the requirements for electromagnetic compatibility standards

- » EN55022

PCB Specification

- » IPC-6016 Class 2
- » Flammability UL 796 / UL94-V0

3.9 MTBF

The following MTBF (Mean Time Before Failure) values were calculated using a combination of manufacturer's test data, if the data was available, and the Telcordia (Bellcore) issue 2 calculation for the remaining parts.

The calculation method used is "Telcordia Issue 2 Method 1 Case 3" in a ground benign, controlled environment (GB,GC). This particular method takes into account varying temperature and stress data and the system is assumed to have not been burned in.

Other environmental stresses (extreme altitude, vibration, salt water exposure, etc) lower MTBF values.

System MTBF (hours): 216156 @ 40°C (w/PCB)



Fans usually shipped with Kontron Europe GmbH products have 50,000-hour typical operating life. The above estimates assume no fan, but a passive heat sinking arrangement. Estimated RTC battery life (as opposed to battery failures) is not accounted for in the above figures and need to be considered separately. Battery life depends on both temperature and operating conditions. When the Kontron unit has external power; the only battery drain is from leakage paths.

3.10 Mechanical Specification

Dimension

» 95.0 mm x 95.0 mm (3.75" x 3.75")

» Height approx. 12mm (0.4")



CAD drawings are available at [EMD CustomerSection](#)

Height

The COM Express® specification defines a module height of 13mm from bottom to heatspreader top:

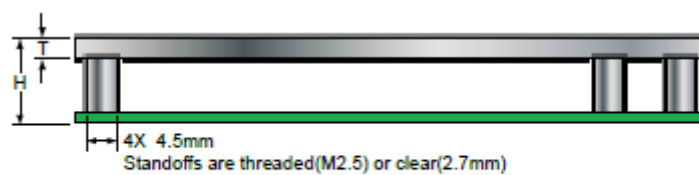

Thickness 'T' is implementation specific and may be 3mm.
Height 'H' (which includes PCB thickness) shall be 13.00mm

Cooling solutions provided from Kontron Europe GmbH for compact sized Computer-on-Modules are 27mm in height from module bottom to Heatsink top. Universal Cooling solutions to be mounted on the HSP (36099-0000-00-x) are 14.3mm in height for an overall height of 27.3mm from module bottom to Heatsink top.

3.11 Module Dimensions

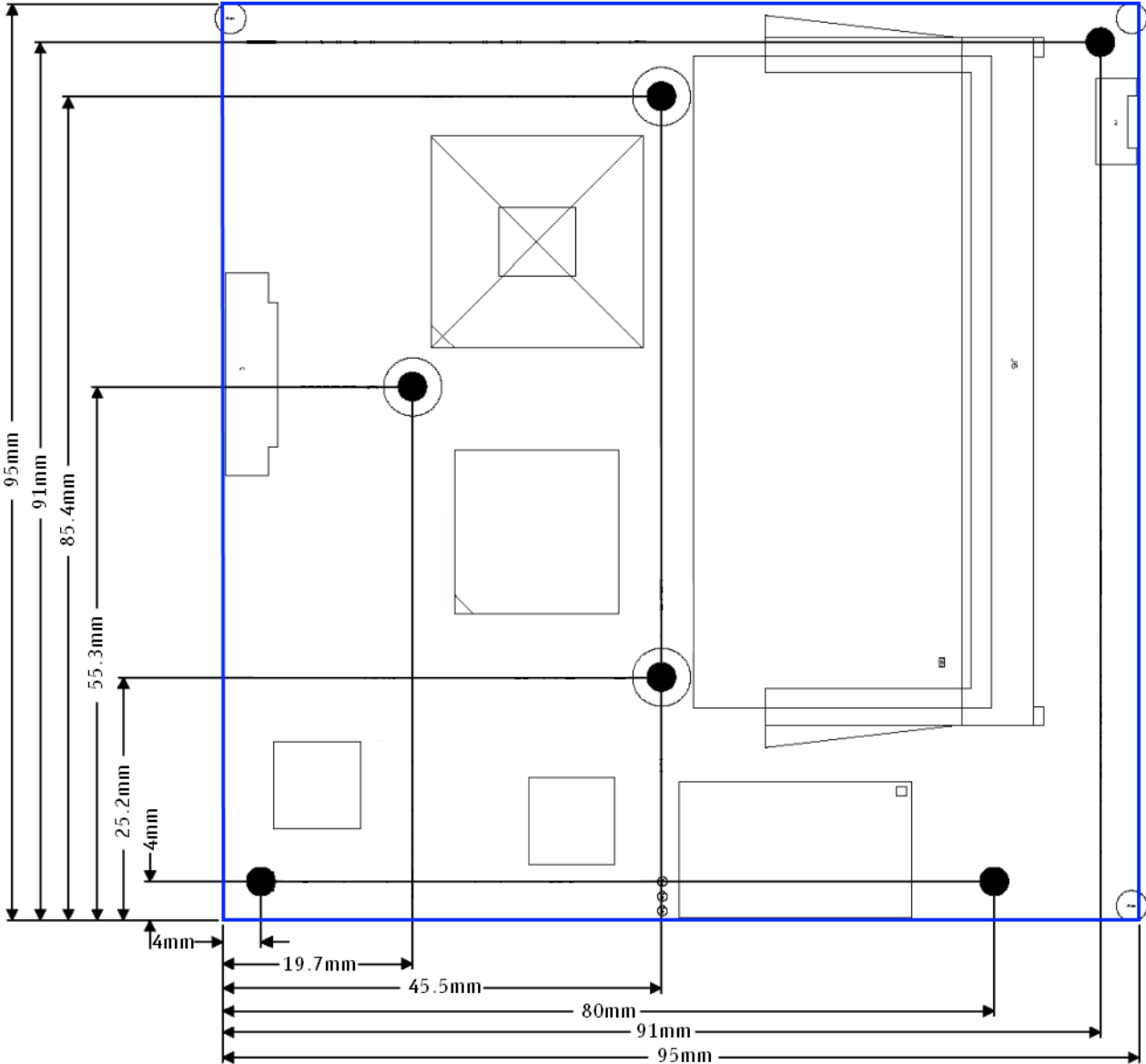

3.12 Thermal Management, Heatspreader and Cooling Solutions

A heatspreader plate assembly is available from Kontron Europe GmbH for the COMe-cCT6. The heatspreader plate on top of this assembly is NOT a heat sink. It works as a COM Express®-standard thermal interface to use with a heat sink or external cooling devices.

External cooling must be provided to maintain the heatspreader plate at proper operating temperatures. Under worst-case conditions, the cooling mechanism must maintain an ambient air and heatspreader plate temperature on any spot of the heatspreader's surface according the module specifications:

- » 60°C for commercial grade modules
- » 75°C for extended temperature grade modules (E1)
- » 85°C for industrial temperature grade modules (E2/XT)

The aluminum slugs and thermal pads or the heat-pipe on the underside of the heatspreader assembly implement thermal interfaces between the heatspreader plate and the major heat-generating components on the COMe-cCT6. About 80 percent of the power dissipated within the module is conducted to the heatspreader plate and can be removed by the cooling solution.

You can use many thermal-management solutions with the heatspreader plates, including active and passive approaches. The optimum cooling solution varies, depending on the COM Express® application and environmental conditions. Active or passive cooling solutions provided from Kontron Europe GmbH for the COMe-cCT6 are usually designed to cover the power and thermal dissipation for a commercial grade temperature range used in a housing with proper air flow.

Documentation and CAD drawings of COMe-cCT6 heatspreader and cooling solutions are provided at <http://emdcustomersection.kontron.com>.

3.13 Onboard Connectors

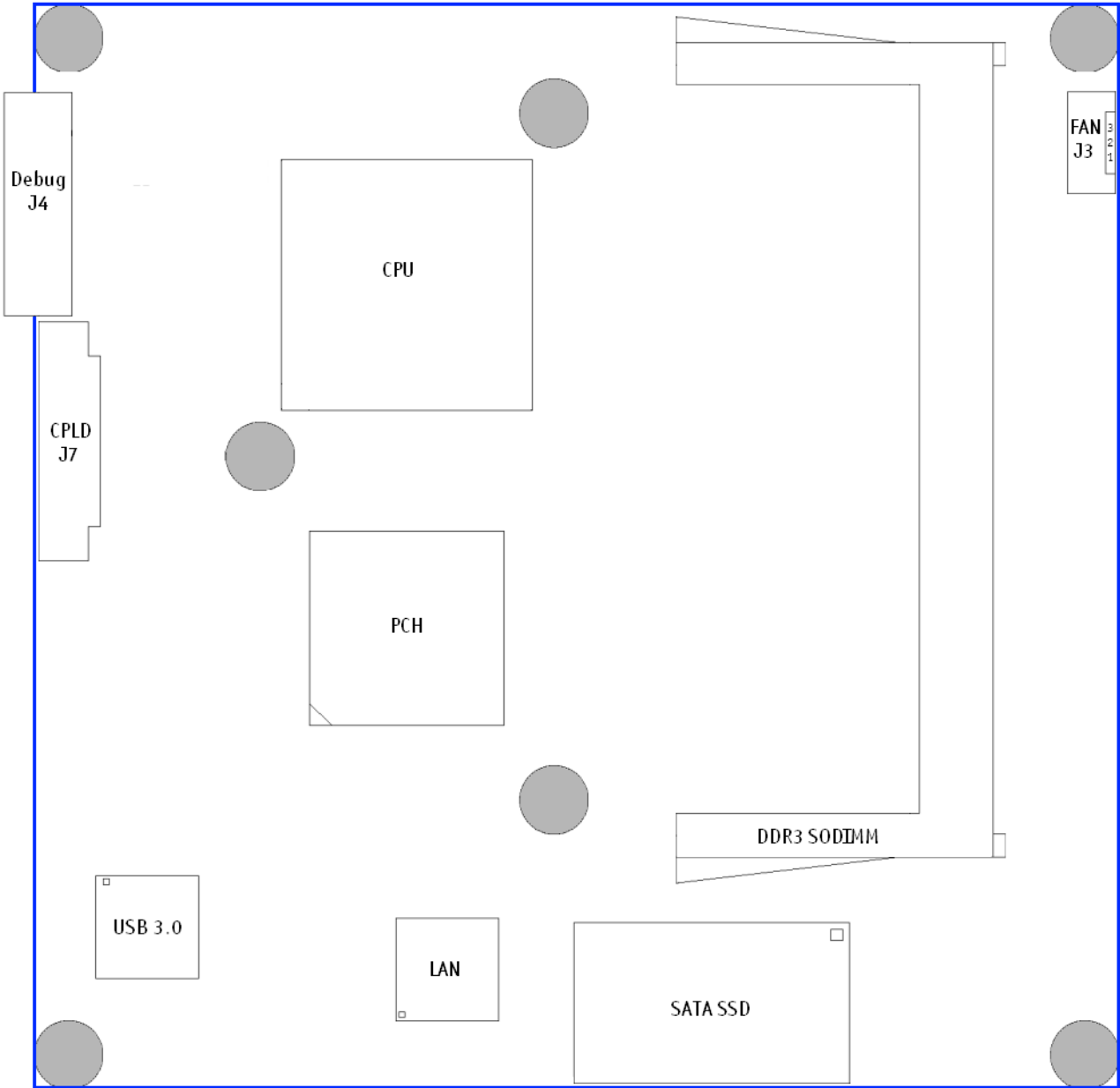

3.13.1 FAN

The COMe-cCT6 supports an onboard FAN connector for active cooling controlled by the BIOS.

Specification of the FAN Connector:

- » Part number (Molex): 53261-0371
- » Mates with: 51021-0300
- » Crimp terminals: 50079-8100

Pin assignment

- » Pin1: Tacho, Pin2: VCC, Pin3: GND

Electrical characteristic

Module Input Voltage	4.75 - 13V	>13V
FAN Output Voltage	4.75 - 13V	13V
Max. FAN Output Current	350mA	150mA



To connect a standard FAN with 3pin connector to the module please use adaptor cable KAB-HSP 200mm (96079-0000-00-0) or KAB-HSP 40mm (96079-0000-00-2)

3.13.2 CPU Debug & CPLD

The CPU Debug connector J4 (not soldered by default) and the CPLD programming interface J7 are for internal use only and should not be used.

4 Features and Interfaces

4.1 Onboard SSD

The COMe-cCT6 features an onboard Greenliant SATA NAND flash drive with capacities of 2-32GB SLC, 2-64GB MLC (SATA). Due to performance and longevity reasons standard variants with onboard flash use SLC type only. The following SATA NANDrives are available:

Basic features of the SATA NANDrives

- » ATA/ATAPI-8 compliant Host interface with 48-bit address feature set and SMART support
- » RoHS compliant NAND flash type
- » SATA 1.5Gb/s Host transfer rate
- » Hardware error detection, correction ECC and advanced wear leveling
- » Bad block management
- » TRIM support
- » SMART support
- » 0°C to +70°C temperature range for MLC types A-M-C/B-M-C
- » -40°C to +85°C temperature range for MLC types B-M-I
- » -40°C to +85°C temperature range for all SLC types

Single-level Cell (SLC) NANDrive™

Flash Part No.	GLS85LS				
Flash Part No.	1002P-S-I-FZJE-ND104	1004P-S-I-FZJE-ND104	1008P-S-I-FZJE-ND104	1016P-S-I-FZJE-ND104	1032P-S-I-FZJE-ND104
Product Revision	CC1	CC1	CC1	CC1	CC1
Flash Size	2GByte	4GByte	8GByte	16GByte	32GByte
Burst Read/Write Speed	35/20 MB/s	70/35 MB/s	70/50 MB/s	70/55 MB/s	120/80 MB/s
Total Bytes	2,000,388,096	4,001,292,288	8,012,390,400	16,013,942,784	32,017,047,552
Active Mode Power	450mW	560mW	750mW	590mW	855mW
Typical P/E Cycles per block	100,000	100,000	60,000	60,000	60,000

(Data based on Datasheet S71432 Rev. 03.100 from 11-2013 and S71445 Rev. 01.400 from 11-2013)

Multi-level Cell (MLC) NANDrive™

Flash Part No.	GLS85LS					
Flash Part No.	1002A-M-C-FZJE-ND103 1002A-M-I-FZJE-ND103	1004A-M-C-FZJE-ND103 1004A-M-I-FZJE-ND103	1008B-M-C-FZJE-ND103 1008B-M-I-FZJE-ND103	1016B-M-C-FZJE-ND103 1016B-M-I-FZJE-ND103	1032B-M-C-FZJE-ND103 1032B-M-I-FZJE-ND103	1064B-M-C-FZJE-ND103 1064B-M-I-FZJE-ND103
Product Revision	CB2	CB2	CB2	CB2	CB2	CB2
Flash Size	2GByte	4GByte	8GByte	16GByte	32GByte	64GByte
Burst Read/Write Speed	35/10 MB/s	35/10 MB/s	35/10 MB/s	70/20 MB/s	70/30 MB/s	110/60 MB/s
Total Bytes	1,941,553,152	3,941,941,248	8,012,390,400	16,013,942,784	32,017,047,552	64,023,257,088
Active Mode Power	360mW	360mW	360mW	440mW	565mW	820mW
Typical P/E Cycles per block	5,000	5,000	5,000	5,000	5,000	5,000

(Data based on Datasheet S71430 Rev 02.00 from 10-2013)

4.2 S5 Eco Mode

Kontron's new high-efficient power-off state S5 Eco enables lowest power-consumption in soft-off state – less than 1 mA compared to the regular S5 state this means a reduction by at least factor 200!

In the "normal" S5 mode the board is supplied by 5V_Stb and needs usually up to 300mA just to stay off. This mode allows to be switched on by power button, RTC event and WakeOnLan, even when it is not necessary. The new S5 Eco mode reduces the current enormous.

The S5 Eco Mode can be enabled in BIOS Setup, when the BIOS supports this feature.

Following prerequisites and consequences occur when S5 Eco Mode is enabled

- » The power button must be pressed at least for 200ms to switch on.
- » Wake via Power button only.
- » "Power On After Power Fail"/"State after G3": only "stay off" is possible

4.3 LPC

The Low Pin Count (LPC) Interface signals are connected to the LPC Bus bridge located in the CPU or chipset. The LPC low speed interface can be used for peripheral circuits such as an external Super I/O Controller, which typically combines legacy-device support into a single IC. The implementation of this subsystem complies with the COM Express® Specification. Implementation information is provided in the COM Express® Design Guide maintained by PICMG. Please refer to the official PICMG documentation for additional information.

The LPC bus does not support DMA (Direct Memory Access) and a clock buffer is required when more than one device is used on LPC. This leads to limitations for ISA bus and SIO (standard I/O 's like Floppy or LPT interfaces) implementations.

All Kontron COM Express® Computer-on-Modules imply BIOS support for following external baseboard LPC Super I/O controller features for the **Winbond/Nuvoton 5V 83627HF/G and 3.3V 83627DHG-P**:

83627HF/G	Phoenix BIOS	AMI CORE8	AMI / Phoenix EFI
PS/2	YES	YES	YES
COM1/COM2	YES	YES	YES
LPT	YES	YES	YES
HWM	YES	YES	NO
Floppy	NO	NO	NO
GPIO	NO	NO	NO
83627DHG-P	Phoenix BIOS	AMI CORE8	AMI / Phoenix EFI
PS/2	YES	YES	YES
COM1/COM2	YES	YES	YES
LPT	YES	YES	YES
HWM	NO	NO	NO
Floppy	NO	NO	NO
GPIO	NO	NO	NO

Features marked as not supported do not exclude OS support (e.g. HWM can be accessed via SMB). For any other LPC Super I/O additional BIOS implementations are necessary. Please contact your local sales or support for further details.

4.4 Serial Peripheral Interface (SPI)

The Serial Peripheral Interface Bus or SPI bus is a synchronous serial data link standard named by Motorola that operates in full duplex mode. Devices communicate in master/slave mode where the master device initiates the data frame. Multiple slave devices are allowed with individual slave select (chip select) lines. Sometimes SPI is called a “four wire” serial bus, contrasting with three, two, and one wire serial buses.



The SPI interface can only be used with a SPI flash device to boot from external BIOS on the baseboard.

4.5 SPI boot

The COMe-cT6 supports boot from an external SPI Flash. It can be configured by pin A34 (BIOS_DIS#0) and pin B88 (BIOS_DIS#1) in following configuration:

BIOS_DIS0#	BIOS_DIS1#	Function
open	open	Boot on-module BIOS
GND	open	Boot baseboard LPC FWH
open	GND	Baseboard SPI = Boot Device 1, on-module SPI = Boot Device 2
GND	GND	Baseboard SPI = Boot Device 2, on-module SPI = Boot Device 1



By default only SPI Boot Device 1 is used in configuration 3 & 4. Both SPI Boot Devices are used by splitting the BIOS with modified descriptor table in customized versions only

Recommended SPI boot flash types for 8-SOIC package

Size	Manufacturer	Part Number	Device ID
16Mbit	Atmel	AT26DF161	0x1F4600
16Mbit	Atmel	AT26DF161A	0x1F4601
16Mbit	Atmel	AT25DF161	0x1F4602
16Mbit	Atmel	AT25DQ161	0x1F8600
16Mbit	Macronix	MX25L1605A(D)(36E)(06E)	0xC22015
16Mbit	Macronix	MX25L1635D	0xC22415
16Mbit	SST/Microchip	SST25VF016B	0xBF2541
16Mbit	Winbond	W25X16BV	0xEF3015
16Mbit	Winbond	W25Q16BV(CV)	0xEF4015
Size	Manufacturer	Part Number	Device ID
32Mbit	Atmel	AT25/26DF321	0x1F4700
32Mbit	Atmel	AT25DF321A	0x1F4701
32Mbit	Macronix	MX25L3205A(D)(06E)	0xC22016
32Mbit	Macronix	MX25L3225D(35D)(36D)	0xC25E16
32Mbit	SST/Microchip	SST25VF032B	0xBF254A
32Mbit	Winbond	W25X32BV	0xEF3016
32Mbit	Winbond	W25Q32BV,	0xEF4016
Size	Manufacturer	Part Number	Device ID
64Mbit	Atmel	AT25DF641(A)	0x1F4800
64Mbit	Atmel	AT25DQ641	0x1F8800
64Mbit	Macronix	MX25L6405D(45E)(36E)(06E)(73E)	0xC22017
64Mbit	Macronix	MX25L6455E	0xC22617
64Mbit	Macronix	MX25U6435F	0xC22537
64Mbit	SST/Microchip	SST25VF064C	0xBF254B
64Mbit	Winbond	W25X64BV	0xEF3017
64Mbit	Winbond	W25Q64BV(CV)(FV)	0XEF4017
64Mbit	Winbond	W25Q64DW	0XEF6017
64Mbit	Winbond	W25Q64FW	0XEF6017

Using an external SPI flash

To program an external SPI flash follow these steps:

- » Connect a SPI flash with correct size (similar to BIOS ROM file size) to the module SPI interface
- » Open pin A34 and B88 to boot from the module BIOS
- » Boot the module to DOS/EFI-Shell with access to the BIOS image and Firmware Update Utility provided on EMD Customer Section
- » Connect pin B88 (BIOS_DIS1#) to ground to enable the external SPI flash
- » Execute Flash.bat/Flash.efi to program the complete BIOS image to the external SPI flash
- » reboot

Your module will now boot from the external SPI flash when BIOS_DIS1# is grounded.

External SPI flash on Modules with Intel® ME

If booting from the external (baseboard mounted) SPI flash then exchanging the COM Express® module for another one of the same type will cause the Intel® Management Engine to fail during next start. This is by design of the ME because it bounds itself to the very module it has been flashed to. In the case of an external SPI flash this is the module present at flash time.

To avoid this issue please make sure to conduct a complete flash of the external SPI flash device after changing the COMexpress module for another one. If disconnecting and reconnecting the same module again this step is not necessary.

4.6 M.A.R.S.

The Smart Battery implementation for Kontron Computer-on-Modules called **M**obile **A**pplication for **R**echargeable **S**ystems is a BIOS extension for external Smart Battery Manager or Charger. It includes support for SMBus charger/selector (e.g. Linear Technology LTC1760 Dual Smart Battery System Manager) and provides ACPI compatibility to report battery information to the Operating System.

Reserved SM-Bus addresses for Smart Battery Solutions on the carrier:

8-bit Address	7-bit Address	Device
12h	0x09	SMART_CHARGER
14h	0x0A	SMART_SELECTOR
16h	0x0B	SMART_BATTERY

4.7 UART

The COMe-cCT6 supports up to two Serial RX/TX only Ports defined in COM Express® specification on Pins A98/A99 for UART0 and Pins A101/A102 for UART1. The implementation of the UART is compatible to 16450 and is supported by default from most operating systems. Resources are subordinated to other UARTS e.g. from external LPC Super I/O.

UART features:

- » 450 to 115.2k Baud (except 56000)
- » 5, 6, 7 or 8bit characters
- » 1 or 2 Stop bit generation
- » Even, odd or no-parity generation/detection
- » Complete status reporting capabilities
- » Line break generation and detection
- » Full prioritized interrupt system control
- » No FIFO
- » One additional shift register for transmit and one for receive
- » No Flow Control
- » No FCR register due to unavailability of FIFO
- » MCR and MSR registers only implemented in loopback mode for compatibility with existing drivers and APIs
- » Initialized per default to COM3 3F8h/IRQ4 and COM4 2F8/IRQ3 without external SIO
- » Initialized per default to COM3 3E8h/IRQ5 and COM4 2E8/IRQ10 with external SIO present

The UART clock is generated by the 33MHz LPC clock which results in an accuracy of 0.5% on all UART timings



- Due to the protection circuitry required according COM Express® specification the transfer speed can only be guaranteed for 9600 Baud. Please contact your local sales or support for customized versions without protection circuitry

- Legacy console redirection via onboard serial ports may be restricted in terms of serial input stream. Since they're only emulating a 16450 device (w/o FIFO) an input stream generated by a program may lose characters. Inputs from a keyboard via terminal program will be safe.

4.8 Fast I2C

The COMe-cCT6 supports a CPLD implemented LPC to I2C bridge using the WISHBONE I2C Master Core provided from opencores.org. The I2C Interface supports transfer rates up to 40kB/s and can be configured in Setup

Specification for external I2C:

- » Speed up to 400kHz
- » Compatible to Philips I2C bus standard
- » Multi-Master capable
- » Clock stretching support and wait state generation
- » Interrupt or bit-polling driven byte-by-byte data-transfers
- » Arbitration lost interrupt with automatic transfer cancellation
- » Start/Stop signal generation/detection
- » Bus busy detection
- » 7bit and 10bit addressing

4.9 GPIO - General Purpose Input and Output

The COMe-cCT6 offers 4 General Purpose Input (GPI) pins and 4 General Purpose Output (GPO) pins. On a 3.3V level digital in- and outputs are available.

Signal	Pin	Description
GPI0	A54	General Purpose Input 0
GPI1	A63	General Purpose Input 1
GPI2	A67	General Purpose Input 2
GPI3	A85	General Purpose Input 3
GPO0	A93	General Purpose Output 0
GPO1	B54	General Purpose Output 1
GPO2	B57	General Purpose Output 2
GPO3	B63	General Purpose Output 3

Configuration



The GPI and GPO pins can be configured via JIDA32/K-Station. Please refer to the JIDA32/K-Station manual in the driver download packet on our [customer section](#).

4.10 Dual Staged Watchdog Timer

Basics

A watchdog timer (or computer operating properly (COP) timer) is a computer hardware or software timer that triggers a system reset or other corrective action if the main program, due to some fault condition, such as a hang, neglects to regularly service the watchdog (writing a "service pulse" to it, also referred to as "kicking the dog", "petting the dog", "feeding the watchdog" or "triggering the watchdog"). The intention is to bring the system back from the nonresponsive state into normal operation.

The COMe-cCT6 offers a watchdog which works with two stages that can be programmed independently and used one by one.

Time-out events

Reset	A reset will restart the module and starts POST and operating system new.
NMI	A non-maskable interrupt (NMI) is a computer processor interrupt that cannot be ignored by standard interrupt masking techniques in the system. It is typically used to signal attention for non-recoverable hardware errors.
SCI	A system control interrupt (SCI) is a OS-visible interrupt to be handled by the OS using AML code
Delay	Might be necessary when an operating system must be started and the time for the first trigger pulse must extended. (Only available in the first stage)
WDT Signal only	This setting triggers the WDT Pin on baseboard connector (COM Express® Pin B27) only
Cascade:	Does nothing, but enables the 2nd stage after the entered time-out.

WDT Signal

B27 on COM Express® Connector offers a signal that can be asserted when a watchdog timer has not been triggered within time. It can be configured to any of the 2 stages. Deassertion of the signal is automatically done after reset. If deassertion during runtime is necessary please ask your Kontron technical support for further help.

4.11 Intel® Fast Flash Standby™ / Rapid Start Technology™

The target of Intel® Fast Flash Standby™ (iFFS) (also known as Intel® Rapid Start Technology™ iRST) is to get a wake-up time from S4 comparable to S3. Normally S4 is caused by OS which stores it's information to the hard disk and does then a normal shutdown. S4 resume takes quite long as the system does a normal BIOS POST and OS restores it's information from the hard disk.

iFFS does it in a different way. The Operating System initiates an S3 and stores it's information in memory. After that BIOS copies this OS information from DRAM to SSD and does a sleep state similar to S4 with nearly zero power. If system is resumed by power button, BIOS restores memory content from SSD to the DRAM and does an S3 resume which is much faster.

Requirements

- » SATA Solid State Disk in AHCI mode
- » Free disk space on the SSD with at least the DRAM size
- » Operating System with disk partition tool to allocate the hibernation partition (e.g. Windows 7/8)
- » BIOS supporting iFFS feature

How to setup once the operating system is installed

- » Prepare a free disk space on your onboard or external SSD with at least the size of DRAM
- » Open *cmd.exe* in Administrator Mode and type *diskpart.exe* to open the Windows disk partition tool
- » DISKPART> list disk
- » DISKPART> select disk X (X is disk number where you want to create the store partition. Refer to results from "list disk" for exact disk number)
- » DISKPART> create partition primary
- » DISKPART> detail disk
- » DISKPART> select Volume X (X is Volume of your store partition. Refer to results from "detail disk" for exact volume number)
- » DISKPART> set id=84 override (ID 84 marks the partition as hibernate partition)
- » DISKPART> exit
- » Now there should be a Hibernate Partition visible in your disk management
- » Reboot and enable iFFS in BIOS

Usage

- » Activate Lid / move system to Sleep/Standby (→S3)
- » After configured period of time in Setup the system powers on automatically and information in DRAM moves to non-volatile memory (Default is '*immediately*')
- » System switches off again to iFFS (→comparable to S4, Power Supply can now be disconnected)
- » When System is powered on, information moved back to DRAM (No display output during copy process)
- » System resumes same as Sleep/Standby S3

Note

- » Depending on the platform iFFS enabled may disable the hibernate function in Windows automatically

Benefits

- » System transitions from S3 to S4 automatically
- » Up to 6x battery life compared to Standby
- » Resume time reduced up to 75%



Measured resume times from Power-on to Win7 Log-on Screen on COMe-mCT10:

- » 2.5" SATA II HDD 5400rpm: Hibernate: 22s, iFFs on onboard NANDrive: 17s
- » 2.5" SATA III SSD: Hibernate: 18s, iFFS on SSD: 10s

4.12 Speedstep Technology

The Intel® processors offer the Intel® Enhanced SpeedStep™ technology that automatically switches between maximum performance mode and battery-optimized mode, depending on the needs of the application being run. It enables you to adapt high performance computing on your applications. When powered by a battery or running in idle mode, the processor drops to lower frequencies (by changing the CPU ratios) and voltage, conserving battery life while maintaining a high level of performance. The frequency is set back automatically to the high frequency, allowing you to customize performance.

In order to use the Intel® Enhanced SpeedStep™ technology the operating system must support SpeedStep™ technology.

By deactivating the SpeedStep feature in the BIOS, manual control/modification of CPU performance is possible. Setup the CPU Performance State in the BIOS Setup or use 3rd party software to control CPU Performance States.

4.13 C-States

New generation platforms include power saving features like SuperLFM, EIST (P-States) or C-States in O/S idle mode.

Activated C-States are able to dramatically decrease power consumption in idle mode by reducing the Core Voltage or switching of parts of the CPU Core, the Core Clocks or the CPU Cache.

Following C-States are defined:

C-State	Description	Function
C0	Operating	CPU fully turned on
C1	Halt State	Stops CPU main internal clocks via software
C1E	Enhanced Halt	Similar to C1, additionally reduces CPU voltage
C2	Stop Grant	Stops CPU internal and external clocks via hardware
C2E	Extended Stop Grant	Similar to C2, additionally reduces CPU voltage
C3	Deep Sleep	Stops all CPU internal and external clocks
C3E	Extended Stop Grant	Similar to C3, additionally reduces CPU voltage
C4	Deeper Sleep	Reduces CPU voltage
C4E	Enhanced Deeper Sleep	Reduces CPU voltage even more and turns off the memory cache
C6	Deep Power Down	Reduces the CPU internal voltage to any value, including 0V
C7	Deep Power Down	Similar to C6, additionally LLC (LastLevelCache) is switched off

C-States are usually enabled by default for low power consumption, but active C-States may influence performance sensitive applications or real-time systems.

» Active C6-State may influence data transfer on external Serial Ports

» Active C7-State may cause lower CPU and Graphics performance

It's recommended to disable C-States / Enhanced C-States in BIOS Setup if any problems occur.

4.14 Hyper Threading

Hyper Threading (officially termed Hyper Threading Technology or HTT) is an Intel®-proprietary technology used to improve parallelization of computations performed on PC's. Hyper-Threading works by duplicating certain sections of the processor—those that store the architectural state but not duplicating the main execution resources. This allows a Hyper-Threading equipped processor to pretend to be two “logical” processors to the host operating system, allowing the operating system to schedule two threads or processes simultaneously. Hyper Threading Technology support always relies on the Operating System.

4.15 Display Configuration

The chapter describes possible display configurations and supported features for the integrated Intel® GMA 3650 / 3600 graphics.

Dual Display Configurations in O/S

Display	N/A	CRT	LVDS fix	LVDS DID	LVDS2DVI	DP	DP2DVI	DP2HDMI	DP2CRT
N/A	-	S	S	S	S	S	S	S	S
CRT	S	-	A	A	A	A	A	A	A
LVDS fix	S	A	-	-	-	A	A	A	A
LVDS DID	S	A	-	-	-	A	A	A	A
LVDS2DVI	S	A	-	-	-	A	A	A	A
DP	S	A	A	A	A	A	A	A	A
DP2DVI	S	A	A	A	A	A	A	A	A
DP2HDMI	S	A	A	A	A	A	A	A	A
DP2CRT	S	A	A	A	A	A	A	A	A
eDP	-	-	-	-	-	-	-	-	-

» S = Single Display

» A = All Modes (Single Display, Clone Mode, Extended Desktop)

» A* = All Modes, but requires a customized BIOS

» - = Not supported

» N/A = Display not attached

Dual Display configurations in Setup and POST

Display	N/A	CRT	LVDS fix	LVDS DID	LVDS2DVI	DP	DP2DVI	DP2HDMI	DP2CRT
N/A	-	S	S	S	S	S	S	S	S
CRT	S	-	C	C*	Twin	C	C	C	C
LVDS fix	S	C	-	-	-	C	C	C	C
LVDS DID	S	C*	-	-	-	C*	C*	C*	C*
LVDS2DVI	S	Twin	-	-	-	C	C	C	C
DP	S	C	C	C*	C	C	C	C	C
DP2DVI	S	C	C	C*	C	C	C	C	C
DP2HDMI	S	C	C	C*	C	C	C	C	C
DP2CRT	S	C	C	C*	C	C	C	C	C
eDP	-	-	-	-	-	-	-	-	-

» S = Single Display

» C = Clone Mode

» C* = Clone Mode, requires manual display configuration in setup. With Auto detection LVDS only is supported

» Twin = Twin Mode with 2 Displays on Display Pipe 1.

» - = Not supported

» N/A = Display not attached



In Clone Mode Display Pipe 2 only shows VESA Modes in POST, Setup and EFI Shell. DOS, Windows boot or the Windows Installation is using VGA Mode which is not supported by Display Pipe 2. With CRT and LVDS with EDID (e.g. LVDS2DVI Adapter) the Twin Mode is active without VESA mode restrictions

Digital Display Interface Features

The integrated Intel® GMA 3650 / 3600 graphics supports:

- » High-bandwidth Digital Content Protection (HDCP)
- » One active Protected Audio and Video Path (PAVP) session
- » DP and HDMI Hot-plug (low-active)

DDI Design Consideration

- » For sufficient signal quality baseboard designs with long signal lanes or impedance leaps may require an Equalizer or Redriver for the digital display interfaces
- » Monitor Hot-plug detection is usually high-active. On COMe-cCT6 the hot-plug is low active and requires conversion on the baseboard
- » SDVO can be used for external conversion to VGA, LVDS, TV-out and requires additional hardware on your baseboard
- » DisplayPort can be used directly or with external adapters for HDMI, DVI or VGA
- » HDMI or DVI usage on a baseboard requires a level shifter



Find more details for DDI usage as DisplayPort, HDMI or DVI with schematic examples available on <http://emdcustomersection.kontron.com>

4.16 Graphics Features

The COMe-cCT6 supports the integrated Intel® GMA 3650 / 3600 graphics based on PowerVR SGX545. Following Operating System and Software Features are supported:

O/S	WEC7	WinXP / XPe	Win7 / WES7	Linux Fedora / Yocto
Recommended VBIOS	EMGD*		GMA*	
Driver	EMGD 1.15	EMGD 1.15	GMA 3600	Linux PowerVR Graphics
Max LVDS Resolution	D2000: 1440×900 N2000: 1366×768			
Max VGA Resolution	D2000/N2000: 1920×1200			
Max HDMI/DVI Resolution	D2000/N2000: 1920×1200			
Max DP Resolution	D2000: 2560×1600 N2000: 1920×1200		D2000: 2560×1600 N2000: 1600×1200	
Max eDP Resolution	D2000: 1920×1080 (1080p) N2000: 1366×768			
Dual Independent Display	Yes			
2D HW Acceleration	-	DirectDraw	DirectDraw	EXA and XRandR
3D HW Acceleration	-	DX9 Direct3D	DX9 Direct3D	OpenGL ES2.0, HTML5WebGL
HW Media Acceleration	SW only	SW only	DXVA	VA API
HW Codecs supported	-	-	H.264, MPEG2, VC-1	H.264, MPEG2
Blu-Ray	-	-	v2.0	-
HDCP	-	v1.3 (HDMI only)	v1.3 (HDMI/DP)	-
Media players	-	-	Windows Media Player PowerDVD 10 Total Media Theatre 3	MPlayer



* The Standard BIOS provided with the module supports the GMA VBIOS only. For any issues of EMGD driver in combination with GMA VBIOS please contact your local sales or support

4.17 Hardware Configuration

The Intel® GMA 3650 / 3600 supports 2 Digital Display Interfaces:

- » DDI0 = HDMI-B or DP-B
- » DDI1 = HDMI-C or DP-C

On COMe-mCT10 only DDI1 is available while on COMe-cCT6 both DDIs are provided on COM Express connector

4.18 Graphics VBIOS and Driver

The COMe-cCT6 standard BIOS supports the GMA Video-BIOS which is optimized for use with GMA Video Driver (Win7/WES7). For use with EMGD driver (Linux, WinXP) Intel® recommends to use the EMGD Video-BIOS. The EMGD VBIOS has to be configured for each System Layout and Display Configuration separately which only allows to use the EMGD VBIOS within a customized BIOS Version. To prepare a EMG Driver and EMGD VBIOS following software is required:

- » Intel® EMGD package: available on EMD Customer Section
- » Documentation how to prepare a driver and VBIOS: Inside EMGD Package
- » C++ Compiler to create a VBIOS
- » AMI MMTool to patch the VBIOS into the Module BIOS

Please contact your local Sales or support for further details or preparing a customized BIOS according your requirements

4.19 ACPI Suspend Modes and Resume Events

The COMe-cCT6 supports the S-states S0, S3, S4, S5. S5eco Support: YES

The following events resume the system from S3:

- » USB Keyboard (1)
- » USB Mouse (1)
- » Power Button
- » WakeOnLan (2)

The following events resume the system from S4:

- » Power Button
- » WakeOnLan (2)

The following events resume the system from S5:

- » Power Button
- » WakeOnLan (2)

The following events resume the system from S5Eco:

- » Power Button



- (1) OS must support wake up via USB devices and baseboard must power the USB Port with StBy-Voltage
- (2) Depending on the Used Ethernet MAC/Phy WakeOnLan must be enabled in BIOS setup and driver options

4.20 USB

The COMe-cCT6 supports 8x USB 2.0 with following internal EHCI/UHCI configuration inside -. xHCI (USB 3.0) is optional available with onboard PCI Express USB 3.0 controller TI TUSB7320

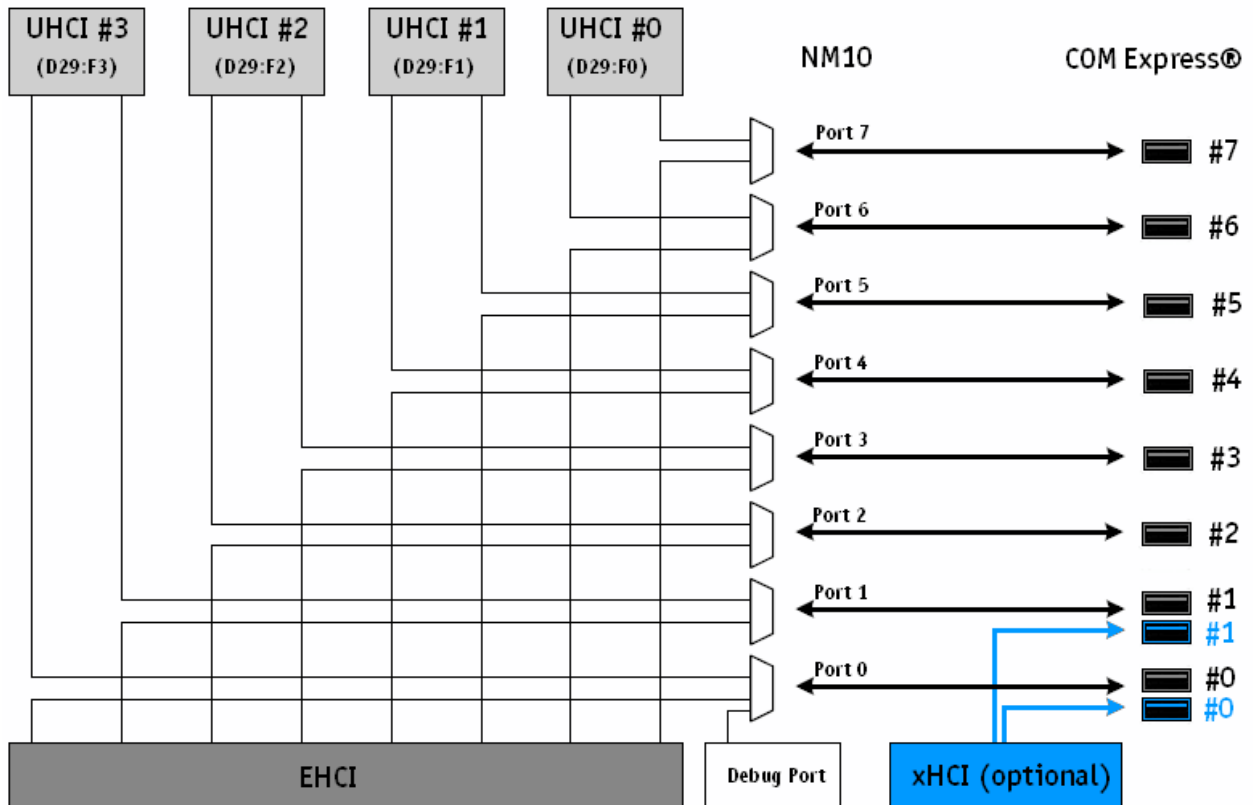

With USB3.0 option the COM Express USB Ports #0 and #1 are not connected to the NM10 UHCI/EHCI controller. Therefore BIOS Settings won't have any affects on these ports

5 System Resources

5.1 Interrupt Request (IRQ) Lines

IRQ #	Used For	Available	Comment
0	Timer0	No	-
1	Keyboard	No	-
2	Cascade	No	-
3	External SIO - COM2	Ext.SIO	Dynamic (BIOS default)
4	External SIO - COM1	Ext.SIO	Dynamic (BIOS default)
5	External SIO - LPT1	Ext.SIO	Dynamic (BIOS default)
6	-	Ext.SIO	-
7	SMBus	No	Note(3)
8	RTC	No	-
9	ACPI	No	-
10	-	Ext.SIO	-
11	-	Ext.SIO	-
12	-	Ext.SIO	-
13	FPU	No	-
14	-	No	-
15	-	No	-
16	LNK A	No	PCIe RP 0 + USB UHCI3; Note(3)
17	LNK B	No	PCIe RP 1; Note(3)
18	LNK C	No	PCIe RP 2 + USB UHCI2 + xHCI; Note(3)
19	LNK D	No	PCIe RP 3 + USB UHCI1 + S-ATA; Note(3)
20	LNK E	No	Note(3)
21	LNK F	No	Note(3)
22	LNK G	No	HDA; Note(3)
23	LNK H	No	USB UHCI0 + USB EHCI; Note(3)



- (1) If the “Used For” device is disabled in setup, the corresponding interrupt is available for other device.
- (2) Not available if ACPI is used
- (3) ACPI OS decides on particular IRQ usage

5.2 Memory Area

The first 640 kB of DRAM are used as main memory. Using DOS, you can address 1MB of memory directly. The memory area above 1 MB (high memory, extended memory) is accessed under DOS via special drivers such as HIMEM.SYS and EMM386.EXE, which are part of the operating system. Please refer to the operating system documentation or special textbooks for information about HIMEM.SYS and EMM386.EXE. Other operating systems (Linux or Windows versions) allow you to address the full memory area directly.

Upper Memory	Used for	Available	Comment
A0000h – BFFFFh	VGA Memory	No	Mainly used by graphic controller
C0000h – CFFFFh	VGA BIOS	No	Used by onboard VGA ROM
D0000h – DFFFFh	-	Yes	Free for shadow RAM in standard configurations.
E0000h – FFFFFh	System BIOS	No	Fixed
E000000h–EFFFFFFFh	PCIe Config Space	No	Fixed
FEC0000h-FEC0FFFh	APCB	No	Fixed
FED0000h-FED03FFh	HPET	No	Fixed
FED14000h-FED17FFFh	MCH	No	Fixed
FED18000h-FED18FFFh	DMI	No	Fixed
FED19000h-FED19FFFh	EPBA	No	Fixed
FED1C000h-FED1FFFFh	RCBA	No	Fixed
FED2000h-FED8FFFFh	Chipset + TPM	No	Fixed
FF00000h-FFFFFFFFh	BIOS Flash	No	Fixed

5.3 I/O Address Map

The I/O-port addresses of the are functionally identical to a standard PC/AT. All addresses not mentioned in this table should be available. We recommend that you do not use I/O addresses below 0100h with additional hardware for compatibility reasons, even if available.

I/O Address	Used for	Available	Comment
0000 - 001F	System Ressources	No	Fixed
0020 - 003F	Interrupt Controller 1	No	Fixed
0040 - 005F	Timer, Counter	No	Fixed
0060 - 006F	Keyboard controller	No	Fixed
0070 - 007F	RTC and CMOS Registers	No	Fixed
0080	BIOS Postcode	No	Fixed
0081 - 009F	DMA Controller	No	Fixed
00A0 - 00BF	Interrupt Controller	No	Fixed
00C0 - 00DF	DMA Controller	No	Fixed
00F0 - 00FF	Math Coprocessor	No	Fixed
0290 - 029F	Ext.SIO	No	Fixed
03B0 - 03DF	VGA	No	Fixed
0400 - 047F	Chipset	No	Fixed
04D0 - 04D1	Chipset	No	Fixed
0500 - 057F	Chipset	No	Fixed
0600 - 061F	Chipset	No	Fixed
0680 - 06FF	Chipset	No	Fixed
0A80 - 0A81	CPLD	No	Fixed
0CF8 - 0CFF	Chipset	No	Fixed

5.4 Peripheral Component Interconnect (PCI) Devices

All devices follow the Peripheral Component Interconnect 2.3 (PCI 2.3) respectively the PCI Express Base 1.0a specification. The BIOS and OS control memory and I/O resources. Please see the PCI 2.3 specification for details.

PCI Device	B:D:F	PCI IRQ	Interface	Comment
Host Bridge	0:00:0	-	internal	Chipset
Video Controller	0:02:0	LNK A	internal	Chipset
HDA	0:1B:0	LNK G	PCIe	Chipset
PCIe Port 0	0:1C:0	LNK A	internal	Chipset
PCIe Port 0 Slot	-	A/B/C/D	PCIe	Port 0
PCIe Port 1	0:1C:1	LNK A	internal	Chipset
PCIe Port 1 Slot	-	B/C/D/A	PCIe	Port 1
PCIe Port 2	0:1C:2	LNK A	internal	Chipset
PCIe Port 2 Slot	-	C/D/A/B	PCIe	Port 2
PCIe Port 3	0:1C:3	LNK A	internal	Chipset
PCIe Port 3 Slot	-	D/A/B/C	PCIe	Port 3
UHCI0	0:1D:0	LNK H	internal	Chipset
UHCI1	0:1D:1	LNK D	internal	Chipset
UHCI2	0:1D:2	LNK C	internal	Chipset
UHCI3	0:1D:3	LNK A	internal	Chipset
EHCI	0:1D:7	LNK H	internal	Chipset
LPC Bridge	0:1F:0	-	internal	Chipset
SATA	0:1F:2	LNK D	internal	Chipset
SMBus	0:1F:3	LNK D	internal	Chipset
GbE	X:00:0	LNK D	PCIe	Slot 3

5.5 I2C Bus

I2C Address	Used For	Available	Comment
A0h	FRU-EEPROM	No	Module EEPROM
AEh	FRU-EEPROM	No	Baseboard EEPROM

5.6 JILI I2C Bus

I2C Address	Used For	Available	Comment
A0h	LVDS-EEPROM	No	EEPROM for LVDS Data

5.7 System Management (SM) Bus

Address	Device	Comment
12h	SMART_CHARGER	Not to be used with any SM bus device except a charger
14h	SMART_SELECTOR	Not to be used with any SM bus device except a selector
16h	SMART_BATTERY	Not to be used with any SM bus device except a battery
58h	HWMonitor	Do not use under any circumstances
A2h	DDR3 Memory Socket	Do not use under any circumstances
D2h	Clock Generator	Do not use under any circumstances

6 Connectors

The pinouts for Interface Connectors X1A and X1B are documented for convenient reference. Please see the COM Express™ Specification and COM Express™ Design Guide for detailed, design-level information.

6.1 Connector Location

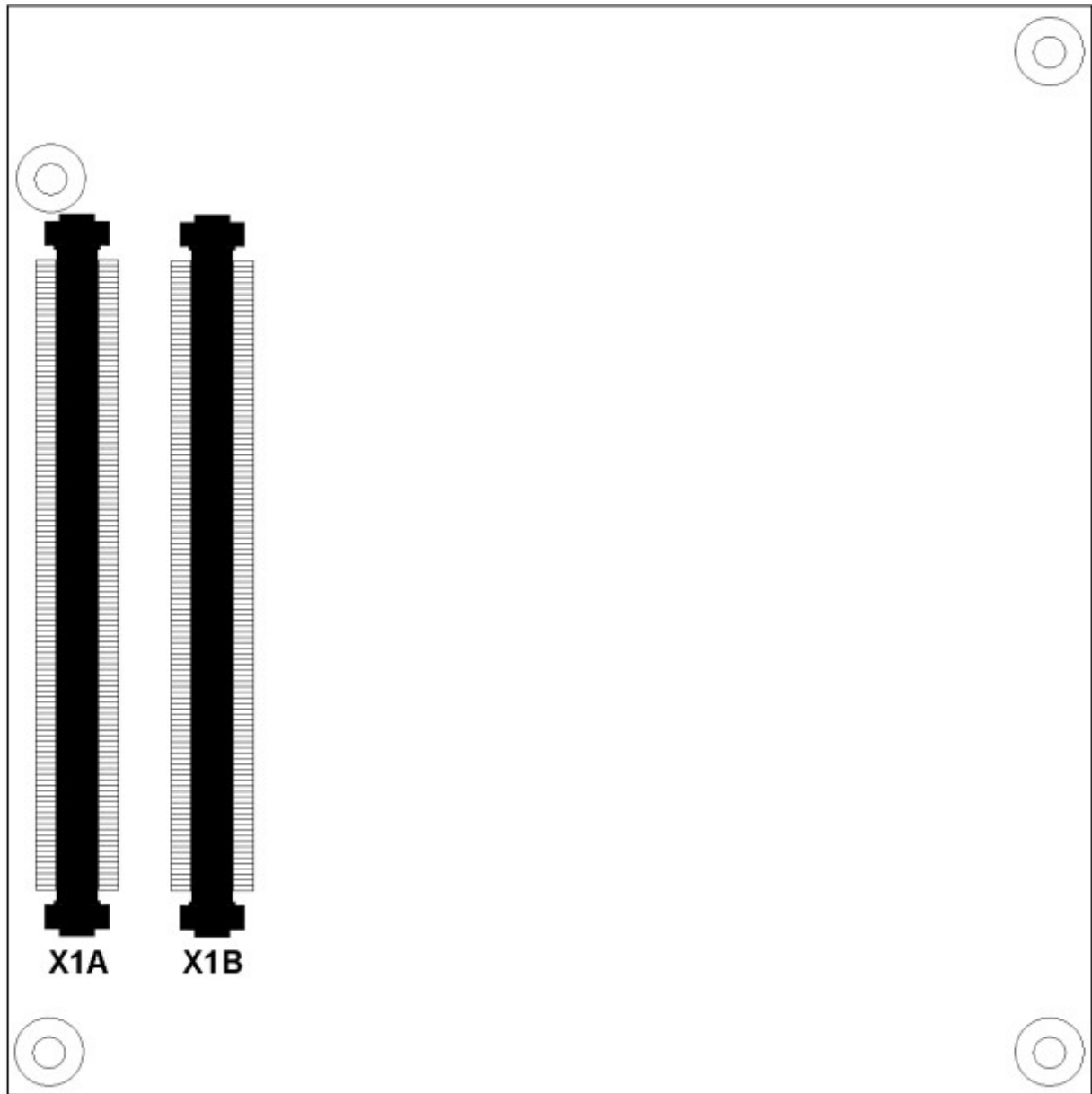

bottom view
(connectors only)

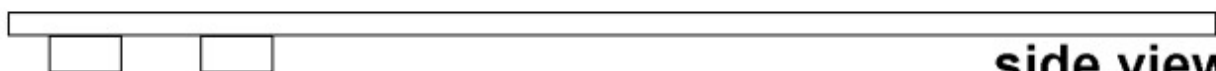

side view
(connectors only)

7 Pinout List

7.1 General Signal Description

Type	Description
I/O-3,3	Bi-directional 3,3 V I/O-Signal
I/O-5T	Bi-dir. 3,3V I/O (5V Tolerance)
I/O-5	Bi-directional 5V I/O-Signal
I-3,3	3,3V Input
I/OD	Bi-directional Input/Output Open Drain
I-5T	3,3V Input (5V Tolerance)
OA	Output Analog
OD	Output Open Drain
O-1,8	1,8V Output
O-3,3	3,3V Output
O-5	5V Output
DP-I/O	Differential Pair Input/Output
DP-I	Differential Pair Input
DP-O	Differential Pair Output
PU	Pull-Up Resistor
PD	Pull-Down Resistor
PWR	Power Connection



To protect external power lines of peripheral devices, make sure that: the wires have the right diameter to withstand the maximum available current the enclosure of the peripheral device fulfills the fire-protection requirements of IEC/EN60950

7.2 Connector X1A Row A

Pin	Signal	Description	Type	Termination	Comment
A1	GND_1	Power Ground	PWR	-	-
A2	GBEO_MDI3-	Ethernet Receive Data-	DP-I	-	-
A3	GBEO_MDI3+	Ethernet Receive Data+	DP-I	-	-
A4	GBEO_LINK100#	Ethernet Speed LED 100Mbps	OD	-	-
A5	GBEO_LINK1000#	Ethernet Speed LED 1000Mbps	OD	-	-
A6	GBEO_MDI2-	Ethernet Receive Data-	DP-I	-	-
A7	GBEO_MDI2+	Ethernet Receive Data+	DP-I	-	-
A8	GBEO_LINK#	LAN Link LED	OD	-	-
A9	GBEO_MDI1-	Ethernet Receive Data-	DP-I	-	-
A10	GBEO_MDI1+	Ethernet Receive Data+	DP-I	-	-
A11	GND_2	Power Ground	PWR	-	-
A12	GBEO_MDIO-	Ethernet Transmit Data-	DP-0	-	-
A13	GBEO_MDIO+	Ethernet Transmit Data+	DP-0	-	-
A14	GBEO_CTREF	LAN Reference Voltage	0-3.3	100nF to GND	-
A15	SUS_S3#	Indicates Suspend to RAM state	0-3.3	-	CPLD I/O
A16	SATA0_TX+	SATA 0 Transmit Data+	DP-0	-	-
A17	SATA0_TX-	SATA 0 Transmit Data-	DP-0	-	-
A18	SUS_S4#	Indicates Suspend to Disk state	0-3.3	-	-
A19	SATA0_RX+	SATA 0 Receive Data+	DP-I	-	-
A20	SATA0_RX-	SATA 0 Receive Data-	DP-I	-	-
A21	GND_3	Power Ground	PWR	-	-
A22	SATA2_TX+	Not Connected	nc	-	-
A23	SATA2_TX-	Not Connected	nc	-	-
A24	SUS_S5#	Indicates Soft Off state	0-3.3	-	CPLD I/O
A25	SATA2_RX+	Not Connected	nc	-	-
A26	SATA2_RX-	Not Connected	nc	-	-
A27	BATLOW#	Indicates low external battery	I-3.3	-	-
A28	ATA_ACT#	SATA Activity Indicator	OD	-	-
A29	HDA_SYNC	HD Audio SYNC	0-3.3	PD 20k in NM10	-
A30	HDA_RST#	HD Audio Reset	0-3.3	-	-
A31	GND_4	Power Ground	PWR	-	-
A32	HDA_CLK	HD Audio CLK	0-3.3	PD 20k in NM10	24MHz
A33	HDA_SDOUT	HD Audio Data	0-3.3	PD 20k in NM10	-
A34	BIOS_DIS0#	Disable Module BIOS.	I-3.3	PU 10k 3.3V_S5	-
A35	THRMTRIP#	CPU thermal shutdown indicator	0-3.3	PU 10k 3.3V_S0	-
A36	USB6-	USB Data- Port #6	DP-I/O	PD 15k in NM10	-
A37	USB6+	USB Data+ Port #6	DP-I/O	PD 15k in NM10	-
A38	USB_6_7_OC#	USB Over current Pair 6 / 7	I-3.3	PU 10k 3.3V_S5	-
A39	USB4-	USB Data- Port #4	DP-I/O	PD 15k in NM10	-
A40	USB4+	USB Data+ Port #4	DP-I/O	PD 15k in NM10	-
A41	GND_5	Power Ground	PWR	-	-
A42	USB2-	USB Data- Port #2	DP-I/O	PD 15k in NM10	-
A43	USB2+	USB Data+ Port #2	DP-I/O	PD 15k in NM10	-
A44	USB_2_3_OC#	USB Over current Pair 2 / 3	I-3.3	PU 10k 3.3V_S5	-
A45	USB0-	USB Data- Port #0	DP-I/O	PD 15k in NM10	-
A46	USB0+	USB Data+ Port #0	DP-I/O	PD 15k in NM10	-
A47	VCC_RTC	RTC Battery Supply +3V	PWR	-	-
A48	EXCD0_PERST#	PCI Express Card 0 Reset	0-3.3	-	-
A49	EXCD0_CPPE#	PCI Express Card 0 Request	I-3.3	PU 8k25 3.3V_S0	-
A50	LPC_SERIRQ	LPC Serial Interrupt Request	IO-3.3	PU 10k 3.3V_S0	-
A51	GND_6	Power Ground	PWR	-	-
A52	PCIE_TX5+	Not Connected	nc	-	-
A53	PCIE_TX5-	Not Connected	nc	-	-
A54	GPIO	General Purpose Input 0	I/O-3.3	PU 10k/100k to V3.3_S0	-
A55	PCIE_TX4+	Not Connected	nc	-	-
A56	PCIE_TX4-	Not Connected	nc	-	-
A57	GND_7	Power Ground	PWR	-	-
A58	PCIE_TX3+	PCIe lane #3 Transmit+ (Optional)	DP-0	-	only available on no-LAN var.
A59	PCIE_TX3-	PCIe lane #3 Transmit- (Optional)	DP-0	-	only available on no-LAN var.
A60	GND_8	Power Ground	PWR	-	-
A61	PCIE_TX2+	PCIe lane #2 Transmit+	DP-0	-	-
A62	PCIE_TX2-	PCIe lane #2 Transmit-	DP-0	-	-
A63	GPI1	General Purpose Input 1	I/O-3.3	PU 10k/100k to V3.3_S0	-
A64	PCIE_TX1+	PCIe lane #1 Transmit+	DP-0	-	-

A65	PCIE_TX1-	PCIe lane #1 Transmit-	DP-0	-	-
A66	GND_9	Power Ground	PWR	-	-
A67	GPI2	General Purpose Input 2	I/O-3.3	PU 10k/100k to V3.3_S0	-
A68	PCIE_TX0+	PCIe lane #0 Transmit+	DP-0	-	-
A69	PCIE_TX0-	PCIe lane #0 Transmit-	DP-0	-	-
A70	GND_10	Power Ground	PWR	-	-
A71	LVDS_A0+	LVDS Channel A DAT0+	DP-0	-	-
A72	LVDS_A0-	LVDS Channel A DAT0-	DP-0	-	-
A73	LVDS_A1+	LVDS Channel A DAT1+	DP-0	-	-
A74	LVDS_A1-	LVDS Channel A DAT1-	DP-0	-	-
A75	LVDS_A2+	LVDS Channel A DAT2+	DP-0	-	-
A76	LVDS_A2-	LVDS Channel A DAT2-	DP-0	-	-
A77	LVDS_VDD_EN	LVDS Panel Power Control	0-3.3	PD 100k	-
A78	LVDS_A3+	LVDS Channel A DAT3+	DP-0	-	-
A79	LVDS_A3-	LVDS Channel A DAT3-	DP-0	-	-
A80	GND_11	Power Ground	PWR	-	-
A81	LVDS_A_CK+	LVDS Channel A Clock+	DP-0	-	20-80MHz
A82	LVDS_A_CK-	LVDS Channel A Clock-	DP-0	-	20-80MHz
A83	LVDS_I2C_CK	LVDS I2C Clock (DDC)	IO-3.3	PU 2k2 3.3V_S0	-
A84	LVDS_I2C_DAT	LVDS I2C Data (DDC)	IO-3.3	PU 2k2 3.3V_S0	-
A85	GPI3	General Purpose Input 3	I/O-3.3	PU 10k/100k to V3.3_S0	-
A86	RSVD	Not Connected	nc	-	-
A87	RSVD	Not Connected	nc	-	-
A88	PCIE0_CK_REF+	PCIe Clock (positive)	DP-0	-	100MHz
A89	PCIE0_CK_REF-	PCIe Clock (negative)	DP-0	-	100MHz
A90	GND_12	Power Ground	PWR	-	-
A91	SPI_POWER	Power supply for Carrier Board SPI	PWR	-	100mA (max.)
A92	SPI_MISO	Data in to Module from Carrier SPI	I-3.3	-	-
A93	GPO0	General Purpose Output 0	0-3.3	- / PD 100k	-
A94	SPI_CLK	Clock from Module to Carrier SPI	0-3.3	-	20MHz
A95	SPI_MOSI	Data out from Module to Carrier SPI	0-3.3	-	-
A96	TPM_PP	(TPM) Physical Presence pin	I-3.3	PD 100k in TPM	-
A97	TYPE10#	Indicates TYPE10# to carrier board	nc	-	-
A98	SERO_TX	UART transmitter	0-3.3	-	14.5V tolerance
A99	SERO_RX	UART receiver	I-3.3	PU 47k 3.3V_S0	14.5V tolerance
A100	GND_14	Power Ground	PWR	-	-
A101	SER1_TX	UART transmitter	0-3.3	-	14.5V tolerance
A102	SER1_RX	UART receiver	I-3.3	PU 47k 3.3V_S0	14.5V tolerance
A103	LID#	LID switch	I-3.3	PU 47k 3.3V_S5	14.5V tolerance
A104	VCC_12V_7	12V VCC	PWR	-	-
A105	VCC_12V_8	12V VCC	PWR	-	-
A106	VCC_12V_9	12V VCC	PWR	-	-
A107	VCC_12V_10	12V VCC	PWR	-	-
A108	VCC_12V_11	12V VCC	PWR	-	-
A109	VCC_12V_12	12V VCC	PWR	-	-
A110	GND_15	Power Ground	PWR	-	-

7.3 Connector X1A Row B

Pin	Signal	Description	Type	Termination	Comment
B1	GND_16	Power Ground	PWR	-	-
B2	GBEO_ACT#	Ethernet Activity LED	OD	-	-
B3	LPC_FRAME#	LPC Frame Indicator	0-3.3	-	-
B4	LPC_ADO	LPC Address / Data Bus	IO-3.3	PU 20k in NM10	-
B5	LPC_AD1	LPC Address / Data Bus	IO-3.3	PU 20k in NM10	-
B6	LPC_AD2	LPC Address / Data Bus	IO-3.3	PU 20k in NM10	-
B7	LPC_AD3	LPC Address / Data Bus	IO-3.3	PU 20k in NM10	-
B8	LPC_DRQ0#	Not Connected	I-3.3	PU 20k in NM10	-
B9	LPC_DRQ1#	Not Connected	I-3.3	PU 20k in NM10	-
B10	LPC_CLK	LPC Clock	0-3.3	-	33MHz
B11	GND_17	Power Ground	PWR	-	-
B12	PWRBTN#	Power Button Input	I-3.3	PU 10k 3.3V_S5	active on falling edge
B13	SMB_CLK	SMBus Clock	0-3.3	PU 10k in S5 / 5k in S0 3.3V	-
B14	SMB_DAT	SMBus Data	IO-3.3	PU 10k in S5 / 5k in S0 3.3V	-
B15	SMB_ALERT#	SMBus Interrupt	IO-3.3	PU 10k 3.3V_S5	-
B16	SATA1_TX+	SATA 1 Transmit Data+	DP-0	-	-
B17	SATA1_TX-	SATA 1 Transmit Data-	DP-0	-	-
B18	SUS_STAT#	Indicates imminent suspend operation	0-3.3	-	-
B19	SATA1_RX+	SATA 1 Receive Data+	DP-I	-	-
B20	SATA1_RX-	SATA 1 Receive Data-	DP-I	-	-
B21	GND_18	Power Ground	PWR	-	-
B22	SATA3_TX+	Not Connected	nc	-	-
B23	SATA3_TX-	Not Connected	nc	-	-
B24	PWR_OK	Power OK from power supply	I-5T	PU 511k 3.3V_S5	CPLD I/O
B25	SATA3_RX+	Not Connected	nc	-	-
B26	SATA3_RX-	Not Connected	nc	-	-
B27	WDT	Indicator for Watchdog Timeout	0-3.3	-	CPLD I/O
B28	HDA_SDIN2	Not Connected	nc	-	not supported
B29	HDA_SDIN1	Audio Codec Serial Data in 1	I-3.3	PD 20k in NM10	-
B30	HDA_SDINO	Audio Codec Serial Data in 0	I-3.3	PD 20k in NM10	-
B31	GND_19	Power Ground	PWR	-	-
B32	SPKR	Speaker Interface	0-3.3	-	-
B33	I2C_CK	General Purpose I2C Clock	IO-3.3	PU 2k2 3.3V_S5	CPLD I/O
B34	I2C_DAT	General Purpose I2C Data	IO-3.3	PU 2k2 3.3V_S5	CPLD I/O
B35	THRM#	Over Temperature Indicator	I-3.3	PU 10k 3.3V_S0	-
B36	USB7-	USB Data- Port #7	DP-I/O	PD 15k in NM10	-
B37	USB7+	USB Data+ Port #7	DP-I/O	PD 15k in NM10	-
B38	USB_4_5_OC#	USB Over current Pair 4 / 5	I-3.3	PU 10k 3.3V_S5	-
B39	USB5-	USB Data- Port #5	DP-I/O	PD 15k in NM10	-
B40	USB5+	USB Data+ Port #5	DP-I/O	PD 15k in NM10	-
B41	GND_20	Power Ground	PWR	-	-
B42	USB3-	USB Data- Port #3	DP-I/O	PD 15k in NM10	-
B43	USB3+	USB Data+ Port #3	DP-I/O	PD 15k in NM10	-
B44	USB_0_1_OC#	USB Over current Pair 0 / 1	I-3.3	PU 10k 3.3V_S5	-
B45	USB1-	USB Data- Port #0	DP-I/O	PD 15k in NM10	-
B46	USB1+	USB Data+ Port #0	DP-I/O	PD 15k in NM10	-
B47	EXCD1_PERST#	PCIe Express Card 1 Reset	0-3.3	-	-
B48	EXCD1_CPPE#	PCIe Express Card 1 Request	I-3.3	PU 8k25 3.3V_S0	-
B49	SYS_RESET#	Reset button input	I-3.3	PU 10k 3.3V_S5	-
B50	CB_RESET#	Carrier Board Reset	0-3.3	-	CPLD I/O
B51	GND_21	Power Ground	PWR	-	-
B52	PCIE_RX5+	Not Connected	nc	-	-
B53	PCIE_RX5-	Not Connected	nc	-	-
B54	GP01	General Purpose Output 1	I/O-3.3	PU 75k V3.3V_S0 / PD 100k	-
B55	PCIE_RX4+	Not Connected	nc	-	-
B56	PCIE_RX4-	Not Connected	nc	-	-
B57	GP02	General Purpose Output 2	I-3.3	PU 10k V3.3V_S0 / PD 100k	-
B58	PCIE_RX3+	PCIe lane #3 Receive+ (Optional)	DP-I	-	only available on no-LAN var.
B59	PCIE_RX3-	PCIe lane #3 Receive- (Optional)	DP-I	-	only available on no-LAN var.
B60	GND_22	Power Ground	PWR	-	-
B61	PCIE_RX2+	PCIe lane #2 Receive+	DP-I	-	-
B62	PCIE_RX2-	PCIe lane #2 Receive-	DP-I	-	-
B63	GP03	General Purpose Output 3	I-3.3	PU 10k V3.3V_S0 / PD 100k	-
B64	PCIE_RX1+	PCIe lane #1 Receive+	DP-I	-	-

B65	PCIE_RX1-	PCIe lane #1 Receive-	DP-I	-	-
B66	WAKE0#	PCI Express Wake Event	I-3.3	PU 1k 3.3V_S5	-
B67	WAKE1#	General Purpose Wake Event	I-3.3	PU 10k 3.3V_S5	-
B68	PCIE_RX0+	PCIe lane #0 Receive+	DP-I	-	-
B69	PCIE_RX0-	PCIe lane #0 Receive-	DP-I	-	-
B70	GND_23	Power Ground	PWR	-	-
B71	LVDS_B0+	Not Connected	nc	-	-
B72	LVDS_B0-	Not Connected	nc	-	-
B73	LVDS_B1+	Not Connected	nc	-	-
B74	LVDS_B1-	Not Connected	nc	-	-
B75	LVDS_B2+	Not Connected	nc	-	-
B76	LVDS_B2-	Not Connected	nc	-	-
B77	LVDS_B3+	Not Connected	nc	-	-
B78	LVDS_B3-	Not Connected	nc	-	-
B79	LVDS_BKLT_EN	Backlight Enable	O-3.3	-	-
B80	GND_24	Power Ground	PWR	-	-
B81	LVDS_B CK+	Not Connected	nc	-	-
B82	LVDS_B CK-	Not Connected	nc	-	-
B83	LVDS_BKLT_CTRL	Backlight Brightness Control	O-3.3	-	-
B84	VCC_5V_SBY	+5V Standby	PWR	-	-
B85	VCC_5V_SBY	+5V Standby	PWR	-	-
B86	VCC_5V_SBY	+5V Standby	PWR	-	-
B87	VCC_5V_SBY	+5V Standby	PWR	-	-
B88	BIOS_DIS1#	Disable Module BIOS.Enable boot from SPI on Baseboard	I-3.3	PU 10k 3.3V_S5	For ext.SPI
B89	CRT_RED	CRT_RED / Analog Video RGB-RED	OA	PD 150R	-
B90	GND_25	Power Ground	PWR	-	-
B91	CRT_GREEN	CRT_GREEN / Analog Video RGB-GREEN	OA	PD 150R	-
B92	CRT_BLUE	CRT_BLUE / Analog Video RGB-BLUE	OA	PD 150R	-
B93	CRT_HSYNC	CRT_HSYNC / Analog Video H-Sync	O-3,3	-	-
B94	CRT_VSYNC	CRT_VSYNC / Analog Video V-Sync	O-3,3	-	-
B95	CRT_DDC_CLK	CRT_DDC_CLK / Display Data Channel Clock	I/O-5	PU 2k21 5.0V_S0	-
B96	CRT_DDC_DATA	CRT_DDC_DATA / Display Data Channel Data	I/O-5	PU 2k21 5.0V_S0	-
B97	SPI_CS#	SPI Chipselect	O	3.3V_S5	-
B98	RSVD	Not Connected	nc	-	-
B99	RSVD	Not Connected	nc	-	-
B100	GND_26	Power Ground	PWR	-	-
B101	FAN_PWMOUT	FAN PWM out	O-3.3	-	14.5V tolerance
B102	FAN_TACHIN	FAN Tacho in	I-3.3	PU 47k 3.3V_S0	14.5V tolerance
B103	SLEEP#	Sleep button	I-3.3	PU 47k 3.3V_S5	14.5V tolerance
B104	VCC_12V_16	12V VCC	PWR	-	-
B105	VCC_12V_17	12V VCC	PWR	-	-
B106	VCC_12V_18	12V VCC	PWR	-	-
B107	VCC_12V_19	12V VCC	PWR	-	-
B108	VCC_12V_20	12V VCC	PWR	-	-
B109	VCC_12V_21	12V VCC	PWR	-	-
B110	GND_27	Power Ground	PWR	-	-

7.4 Connector X1B Row C

Pin	Signal	Description	Type	Termination	Comment
C1	GND	Power Ground	PWR	-	-
C2	GND	Power Ground	PWR	-	-
C3	USB_SSRX0-	USB Super Speed Receive - (0)	DP-I	-	-
C4	USB_SSRX0+	USB Super Speed Receive + (0)	DP-I	-	-
C5	GND	Power Ground	PWR	-	-
C6	USB_SSRX1-	USB Super Speed Receive - (1)	DP-I	-	-
C7	USB_SSRX1+	USB Super Speed Receive + (1)	DP-I	-	-
C8	GND	Power Ground	PWR	-	-
C9	USB_SSRX2-	Not Connected	nc	-	-
C10	USB_SSRX2+	Not Connected	nc	-	-
C11	GND	Power Ground	PWR	-	-
C12	USB_SSRX3-	Not Connected	nc	-	-
C13	USB_SSRX3+	Not Connected	nc	-	-
C14	GND	Power Ground	PWR	-	-
C15	DDI1_PAIR6+	Not Connected	nc	-	-
C16	DDI1_PAIR6-	Not Connected	nc	-	-
C17	RSVD	Not Connected	nc	-	-
C18	RSVD	Not Connected	nc	-	-
C19	PCIE_RX6+	Not Connected	nc	-	-
C20	PCIE_RX6-	Not Connected	nc	-	-
C21	GND	Power Ground	PWR	-	-
C22	PCIE_RX7+	Not Connected	nc	-	-
C23	PCIE_RX7-	Not Connected	nc	-	-
C24	DDI1_HPD	DDI1 Hotplug Detect	I-3,3	PD 1M	-
C25	DDI1_PAIR4+	Not Connected	nc	-	-
C26	DDI1_PAIR4-	Not Connected	nc	-	-
C27	RSVD	Not Connected	nc	-	-
C28	RSVD	Not Connected	nc	-	-
C29	DDI1_PAIR5+	Not Connected	nc	-	-
C30	DDI1_PAIR5-	Not Connected	nc	-	-
C31	GND	Power Ground	PWR	-	-
C32	DDI2_CTRLCLK_AUX+	DDI2 CTRLCLK/AUX+	I/0-3,3	-	-
C33	DDI2_CTRLDATA_AUX-	DDI2 CTRLDATA/AUX-	I/0-3,3	-	-
C34	DDI2_DDC_AUX_SEL	DDI2 DDC/AUX select	I-3,3	PD 1M	-
C35	RSVD	n.c.	nc	-	-
C36	DDI3_CTRLCLK_AUX+	Not Connected	nc	-	-
C37	DDI3_CTRLDATA_AUX-	Not Connected	nc	-	-
C38	DDI3_DDC_AUX_SEL	Not Connected	nc	-	-
C39	DDI3_PAIR0+	Not Connected	nc	-	-
C40	DDI3_PAIR0-	Not Connected	nc	-	-
C41	GND	Power Ground	PWR	-	-
C42	DDI3_PAIR1+	Not Connected	nc	-	-
C43	DDI3_PAIR1-	Not Connected	nc	-	-
C44	DDI3_HPD	Not Connected	nc	-	-
C45	RSVD	Not Connected	nc	-	-
C46	DDI3_PAIR2+	Not Connected	nc	-	-
C47	DDI3_PAIR2-	Not Connected	nc	-	-
C48	RSVD	Not Connected	nc	-	-
C49	DDI3_PAIR3+	Not Connected	nc	-	-
C50	DDI3_PAIR3-	Not Connected	nc	-	-
C51	GND	Power Ground	PWR	-	-
C52	PEG_RX0+	Not Connected	nc	-	-
C53	PEG_RX0-	Not Connected	nc	-	-
C54	TYPE0#	n.c. for type 6 module	nc	-	-
C55	PEG_RX1+	Not Connected	nc	-	-
C56	PEG_RX1-	Not Connected	nc	-	-
C57	TYPE1#	n.c. for type 6 module	nc	-	-
C58	PEG_RX2+	Not Connected	nc	-	-
C59	PEG_RX2-	Not Connected	nc	-	-
C60	GND	Power Ground	PWR	-	-
C61	PEG_RX3+	Not Connected	nc	-	-
C62	PEG_RX3-	Not Connected	nc	-	-
C63	RSVD	Not Connected	nc	-	-
C64	RSVD	Not Connected	nc	-	-

C65	PEG_RX4+	Not Connected	nc	-	-
C66	PEG_RX4-	Not Connected	nc	-	-
C67	RSVD	Not Connected	nc	-	-
C68	PEG_RX5+	Not Connected	nc	-	-
C69	PEG_RX5-	Not Connected	nc	-	-
C70	GND	Power Ground	PWR	-	-
C71	PEG_RX6+	Not Connected	nc	-	-
C72	PEG_RX6-	Not Connected	nc	-	-
C73	GND	Power Ground	PWR	-	-
C74	PEG_RX7+	Not Connected	nc	-	-
C75	PEG_RX7-	Not Connected	nc	-	-
C76	GND	Power Ground	PWR	-	-
C77	RSVD	Not Connected	nc	-	-
C78	PEG_RX8+	Not Connected	nc	-	-
C79	PEG_RX8-	Not Connected	nc	-	-
C80	GND	Power Ground	PWR	-	-
C81	PEG_RX9+	Not Connected	nc	-	-
C82	PEG_RX9-	Not Connected	nc	-	-
C83	RSVD	Not Connected	nc	-	-
C84	GND	Power Ground	PWR	-	-
C85	PEG_RX10+	Not Connected	nc	-	-
C86	PEG_RX10-	Not Connected	nc	-	-
C87	GND	Power Ground	PWR	-	-
C88	PEG_RX11+	Not Connected	nc	-	-
C89	PEG_RX11-	Not Connected	nc	-	-
C90	GND	Power Ground	PWR	-	-
C91	PEG_RX12+	Not Connected	nc	-	-
C92	PEG_RX12-	Not Connected	nc	-	-
C93	GND	Power Ground	PWR	-	-
C94	PEG_RX13+	Not Connected	nc	-	-
C95	PEG_RX13-	Not Connected	nc	-	-
C96	GND	Power Ground	PWR	-	-
C97	RSVD	Not Connected	nc	-	-
C98	PEG_RX14+	Not Connected	nc	-	-
C99	PEG_RX14-	Not Connected	nc	-	-
C100	GND	Power Ground	PWR	-	-
C101	PEG_RX15+	Not Connected	nc	-	-
C102	PEG_RX15-	Not Connected	nc	-	-
C103	GND	Power Ground	PWR	-	-
C104	VCC_12V	12V VCC	PWR	-	-
C105	VCC_12V	12V VCC	PWR	-	-
C106	VCC_12V	12V VCC	PWR	-	-
C107	VCC_12V	12V VCC	PWR	-	-
C108	VCC_12V	12V VCC	PWR	-	-
C109	VCC_12V	12V VCC	PWR	-	-
C110	GND	Power Ground	PWR	-	-

7.5 Connector X1B Row D

Pin	Signal	Description	Type	Termination	Comment
D1	GND	Power Ground	PWR	-	-
D2	GND	Power Ground	PWR	-	-
D3	USB_SSTX0-	USB Super Speed Transmit - (0)	DP-0	-	-
D4	USB_SSTX0+	USB Super Speed Transmit + (0)	DP-0	-	-
D5	GND	Power Ground	PWR	-	-
D6	USB_SSTX1-	USB Super Speed Transmit - (1)	DP-0	-	-
D7	USB_SSTX1+	USB Super Speed Transmit + (1)	DP-0	-	-
D8	GND	Power Ground	PWR	-	-
D9	USB_SSTX2-	Not Connected	nc	-	-
D10	USB_SSTX2+	Not Connected	nc	-	-
D11	GND	Power Ground	PWR	-	-
D12	USB_SSTX3-	Not Connected	nc	-	-
D13	USB_SSTX3+	Not Connected	nc	-	-
D14	GND	Power Ground	PWR	-	-
D15	DDI1_CTRLCLK_AUX+	DDI1 CTRLCLK/AUX+	I/O-3,3	-	-
D16	DDI1_CTRLDATA_AUX-	DDI1 CTRLDATA/AUX-	I/O-3,3	-	-
D17	RSVD	Not Connected	nc	-	-
D18	RSVD	Not Connected	nc	-	-
D19	PCIE_TX6+	Not Connected	nc	-	-
D20	PCIE_TX6-	Not Connected	nc	-	-
D21	GND	Power Ground	PWR	-	-
D22	PCIE_TX7+	Not Connected	nc	-	-
D23	PCIE_TX7-	Not Connected	nc	-	-
D24	RSVD	Not Connected	nc	-	-
D25	RSVD	Not Connected	nc	-	-
D26	DDI1_PAIR0+	DDI1 Pair 0 +	DP-0	-	-
D27	DDI1_PAIR0-	DDI1 Pair 0 -	DP-0	-	-
D28	RSVD	Not Connected	nc	-	-
D29	DDI1_PAIR1+	DDI1 Pair 1 +	DP-0	-	-
D30	DDI1_PAIR1-	DDI1 Pair 1 -	DP-0	-	-
D31	GND	Power Ground	PWR	-	-
D32	DDI1_PAIR2+	DDI1 Pair 2 +	DP-0	-	-
D33	DDI1_PAIR2-	DDI1 Pair 2 -	DP-0	-	-
D34	DDI1_DDC_AUX_SEL	DDI1 DDC/AUX select	I-3,3	PD 1M	-
D35	RSVD	Not Connected	nc	-	-
D36	DDI1_PAIR3+	DDI1 Pair 3 +	DP-0	-	-
D37	DDI1_PAIR3-	DDI1 Pair 3 -	DP-0	-	-
D38	RSVD	Not Connected	nc	-	-
D39	DDI2_PAIR0+	DDI2 Pair 0 +	DP-0	-	-
D40	DDI2_PAIR0-	DDI2 Pair 0 -	DP-0	-	-
D41	GND	Power Ground	PWR	-	-
D42	DDI2_PAIR1+	DDI2 Pair 1 +	DP-0	-	-
D43	DDI2_PAIR1-	DDI2 Pair 1 -	DP-0	-	-
D44	DDI2_HPD	DDI2 Hotplug Detect	I-3,3	PD 1M	-
D45	RSVD	Not Connected	nc	-	-
D46	DDI2_PAIR2+	DDI2 Pair 2 +	DP-0	-	-
D47	DDI2_PAIR2-	DDI2 Pair 2 -	DP-0	-	-
D48	RSVD	Not Connected	nc	-	-
D49	DDI2_PAIR3+	DDI2 Pair 3 +	DP-0	-	-
D50	DDI2_PAIR3-	DDI2 Pair 3 -	DP-0	-	-
D51	GND	Power Ground	PWR	-	-
D52	PEG_TX0+	Not Connected	nc	-	-
D53	PEG_TX0-	Not Connected	nc	-	-
D54	PEG_LANE_RV#	Not Connected	nc	-	-
D55	PEG_TX1+	Not Connected	nc	-	-
D56	PEG_TX1-	Not Connected	nc	-	-
D57	TYPE2#	GND for type 6 module	PWR	-	-
D58	PEG_TX2+	Not Connected	nc	-	-
D59	PEG_TX2-	Not Connected	nc	-	-
D60	GND	Power Ground	PWR	-	-
D61	PEG_TX3+	Not Connected	nc	-	-
D62	PEG_TX3-	Not Connected	nc	-	-
D63	RSVD	Not Connected	nc	-	-
D64	RSVD	Not Connected	nc	-	-

D65	PEG_TX4+	Not Connected	nc	-	-
D66	PEG_TX4-	Not Connected	nc	-	-
D67	GND	Power Ground	PWR	-	-
D68	PEG_TX5+	Not Connected	nc	-	-
D69	PEG_TX5-	Not Connected	nc	-	-
D70	GND	Power Ground	PWR	-	-
D71	PEG_TX6+	Not Connected	nc	-	-
D72	PEG_TX6-	Not Connected	nc	-	-
D73	GND	Power Ground	PWR	-	-
D74	PEG_TX7+	Not Connected	nc	-	-
D75	PEG_TX7-	Not Connected	nc	-	-
D76	GND	Power Ground	PWR	-	-
D77	RSVD	Not Connected	nc	-	-
D78	PEG_TX8+	Not Connected	nc	-	-
D79	PEG_TX8-	Not Connected	nc	-	-
D80	GND	Power Ground	PWR	-	-
D81	PEG_TX9+	Not Connected	nc	-	-
D82	PEG_TX9-	Not Connected	nc	-	-
D83	RSVD	Not Connected	nc	-	-
D84	GND	Power Ground	PWR	-	-
D85	PEG_TX10+	Not Connected	nc	-	-
D86	PEG_TX10-	Not Connected	nc	-	-
D87	GND	Power Ground	PWR	-	-
D88	PEG_TX11+	Not Connected	nc	-	-
D89	PEG_TX11-	Not Connected	nc	-	-
D90	GND	Power Ground	PWR	-	-
D91	PEG_TX12+	Not Connected	nc	-	-
D92	PEG_TX12-	Not Connected	nc	-	-
D93	GND	Power Ground	PWR	-	-
D94	PEG_TX13+	Not Connected	nc	-	-
D95	PEG_TX13-	Not Connected	nc	-	-
D96	GND	Power Ground	PWR	-	-
D97	RSVD	Not Connected	nc	-	-
D98	PEG_TX14+	Not Connected	nc	-	-
D99	PEG_TX14-	Not Connected	nc	-	-
D100	GND	Power Ground	PWR	-	-
D101	PEG_TX15+	Not Connected	nc	-	-
D102	PEG_TX15-	Not Connected	nc	-	-
D103	GND	Power Ground	PWR	-	-
D104	VCC_12V	12V VCC	PWR	-	-
D105	VCC_12V	12V VCC	PWR	-	-
D106	VCC_12V	12V VCC	PWR	-	-
D107	VCC_12V	12V VCC	PWR	-	-
D108	VCC_12V	12V VCC	PWR	-	-
D109	VCC_12V	12V VCC	PWR	-	-
D110	GND	Power Ground	PWR	-	-



The termination resistors in this table are already mounted on the module. Refer to the design guide for information about additional termination resistors.

8 BIOS Operation

The module is equipped with AMI® Aptio, which is located in an onboard SPI serial flash memory.

8.1 Determining the BIOS Version

The AMI® Aptio version is displayed in the main menu of the setup utility.

- » BIOS Vendor: American Megatrends
- » Core Version: x.x.x.x
- » BIOS Date: mm/dd/yyyy hh:mm:ss
- » BIOS Version: UUP6RXXX

8.2 BIOS Update

Kontron provides continuous BIOS updates for Computer-on-Modules. The updates are provided for download on <http://emdcustomersection.kontron.com> with a detailed change description within the according Product Change Notification (PCN). Please register for EMD Customer Section to get access to BIOS downloads and PCN service.

Modules with BIOS Region/Setup only inside the flash can be updated with AFU utilities (usually 1-3MB BIOS binary file size) directly. Modules with Intel® Management Engine, Ethernet, Flash Descriptor and other options additionally to the BIOS Region (usually 4-8MB BIOS binary file size) requires a different update process with Intel Flash Utility FPT and a wrapper to backup and restore configurations and the MAC address. Therefore it is strongly recommended to use the batch file inside the BIOS download package available on EMD Customer Section.

» Boot the module to DOS/EFI Shell with access to the BIOS image and Firmware Update Utility provided on EMD Customer Section

- » Execute Flash.bat in DOS or Flash.nsh in EFI Shell



Any modification of the update process may damage your module!

Backup the BIOS / Create a BIOS with custom defaults:

- » Change your BIOS settings according your needs
- » Save and Exit Setup with option "Save as User Defaults". Your customized settings are now stored inside the flash in a second area additional to the manufacturer defaults
- » Boot the module to DOS or EFI Shell with access to the update utilities
- » Extract the BIOS region including your custom defaults with **afuefix64.efi CBIOS.bin /O** in EFI Shell or **afudos.exe CBIOS.rom /O** in DOS

Now you can clone the BIOS with your customized default settings to other modules or external SPI flashes with above mention AFU utilites. On modules with Management Engine and Ethernet inside the Flash the same BIOS core version should already be programmed on the target.



AMI APTIO update utilities for DOS, EFI Shell and Windows are available for free at AMI.com:
<http://www.ami.com/support/downloads/amiflash.zip>

8.3 Setup Guide

The Aptio Setup Utility changes system behavior by modifying the Firmware configuration. The setup program uses a number of menus to make changes and turn features on or off.

Functional keystrokes in POST:

Key	Function
DEL	Enter Setup
F2	Enter Setup
F7	Boot Menu

8.4 POST Codes

Important POST codes during boot-up

AB	BIOS Setup
AD	EFI Shell
AE	Windows

8.4.1 Start AMI® Aptio Setup Utility

To start the AMI® BIOS setup utility, press or <F2> when the following string appears during bootup.

Press to enter Setup

The Info Menu then appears.

The Setup Screen is composed of several sections:

Setup Screen	Location	Function
Menu Bar	Top	Lists and selects all top level menus.
Legend Bar	Right side Bottom	Lists setup navigation keys.
Item Specific Help Window	Right side Top	Help for selected item.
Menu Window	Left Center	Selection fields for current menu.

Menu Bar

The menu bar at the top of the window lists different menus. Use the left/right arrow keys to make a selection.

Legend Bar

Use the keys listed in the legend bar on the bottom to make your selections or exit the current menu. The table below describes the legend keys and their alternates.

Key	Function
← or → Arrow key	Select a menu.
↑ or ↓ Arrow key	Select fields in current menu.
<Home> or <End>	Move cursor to top or bottom of current window.
<PgUp> or <PgDn>	Move cursor to next or previous page.
+/-	Change Option
<Enter>	Execute command or select submenu.
<F1>	General Help window.
<F2>	Previous Values
<F3>	Load the optimized default configuration.
<F4>	Save and exit.
<Esc>	Exit menu.

Selecting an Item

Use the ↑ or ↓ key to move the cursor to the field you want. Then use the + and – keys to select a value for that field. The Save Value commands in the Exit menu save the values displayed in all the menus.

Displaying Submenus

Use the ← or → key to move the cursor to the submenu you want. Then press <Enter>. A pointer (▶) marks all submenus.

Item Specific Help Window

The Help window on the right side of each menu displays the Help text for the selected item. It updates as you move the cursor to each field.

General Help Window

Pressing <F1> on a menu brings up the General Help window that describes the legend keys and their alternates. Press <Esc> to exit the General Help window.

Platform Information

```
Aptio Setup Utility - Copyright (C) 2012 American Megatrends, Inc.
Main
Module Information
Product Name      COMe-cCT6
Revision          0.2.2
Serial #          NFD060012
MAC Address       00:E0:4B:40:11:23
CPLD Rev         P504.0023 Release
Boot counter      5

><: Select Screen
↑↓: Select Item
Enter: Select
+/-: Change Opt.
F1: General Help
F2: Previous Values
F3: Optimized Defaults
F4: Save & Exit
ESC: Exit

Version 2.15.1227. Copyright (C) 2012 American Megatrends, Inc.
```

8.5.2 Advanced

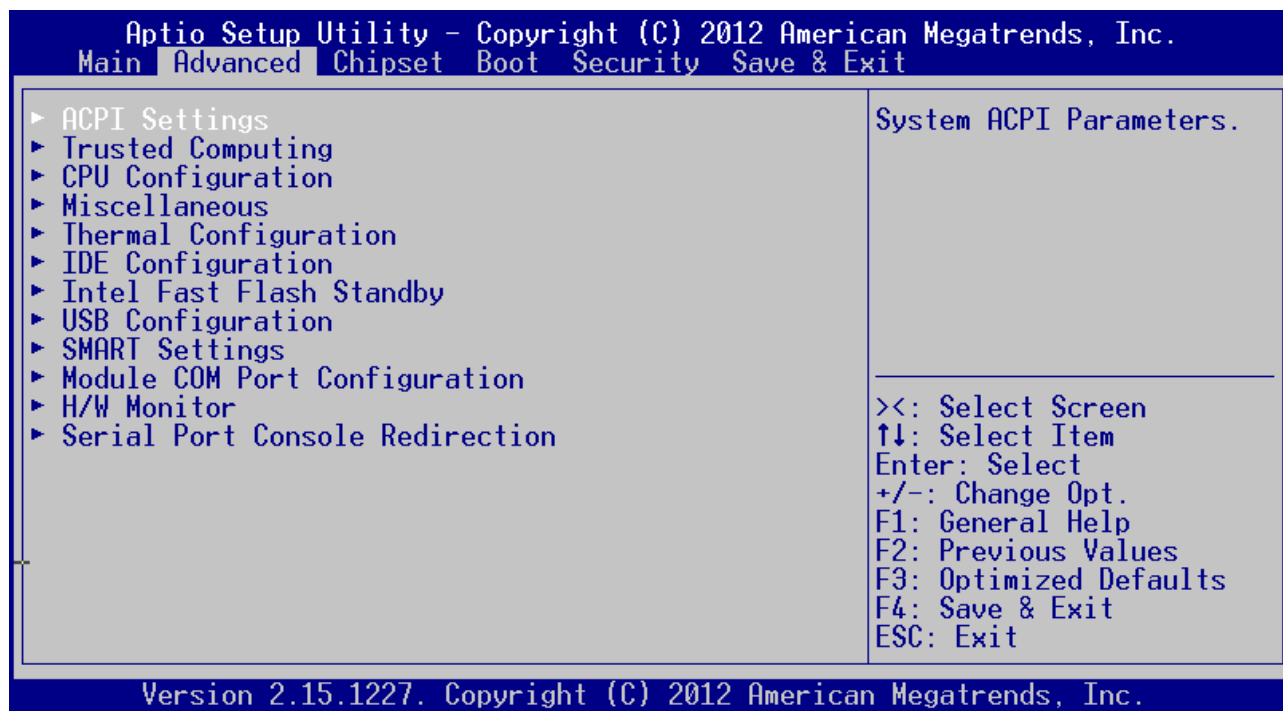

ACPI Settings

Aptio Setup Utility - Copyright (C) 2011 American Megatrends, Inc.

Advanced

<p>ACPI Settings</p> <p>Enable ACPI Auto Conf [Disabled]</p> <p>Enable Hibernation [Enabled]</p> <p>ACPI Sleep State [S3 (Suspend to RAM)]</p> <p>Lock Legacy Resources [Disabled]</p> <p>S3 Video Repost [Disabled]</p>	<p>Enables or Disables BIOS ACPI Auto Configuration.</p> <hr/> <p>><: Select Screen ↑↓: Select Item Enter: Select +/-: Change Opt. F1: General Help F2: Previous Values F3: Optimized Defaults F4: Save & Exit ESC: Exit</p>
---	--

Version 2.14.1219. Copyright (C) 2011 American Megatrends, Inc.

Feature	Options	Description
Enable ACPI Auto Configuration	Disabled Enabled	Enables or Disables BIOS ACPI Auto Configuration
Enable Hibernation	Disabled Enabled	Enables or Disables System ability to Hibernate (OS/S4 Sleep State)
ACPI Sleep State	Suspend Disabled S3 (StR)	Select the highest ACPI sleep state the system will enter when the SUSPEND button is pressed
Lock Legacy Resources	Disabled Enabled	Enables or Disables Lock of Legacy Resources
S3 video Repost	Disabled Enabled	Enable or Disable S3 Video Repost

Trusted Computing

Some setup options are available with TPM option only.

```

Aptio Setup Utility - Copyright (C) 2012 American Megatrends, Inc.
  Advanced
-----
Configuration
Security Device Sup  [Disable]

Current Status Information
SUPPORT TURNED OFF

><: Select Screen
↑↓: Select Item
Enter: Select
+/-: Change Opt.
F1: General Help
F2: Previous Values
F3: Optimized Defaults
F4: Save & Exit
ESC: Exit

Version 2.15.1227. Copyright (C) 2012 American Megatrends, Inc.

```

Feature	Options	Description
Security Device Support	Disable Enable	Enable or Disable BIOS support for security device. O.S. will not show Security Device. TCG EFI protocol and INT1A interface will not be available.
TPM State	Disabled Enabled	Enable/Disable Security Device. Note: Your Computer will reboot during restart in order to change State of the Device
Pending Operation	None Enable Take Ownership Disable Take Ownership TPM Clear	Schedule an Operation for the Security Device. Note: Your Computer will reboot during restart in order to change State of the Device

CPU Configuration

Aptio Setup Utility - Copyright (C) 2012 American Megatrends, Inc.

Advanced

CPU Configuration		
Processor Type	Intel(R) Atom(TM) CPU D2550	Enabled for Windows XP and Linux (OS optimized for Hyper-Threading Technology) and Disabled for other OS (OS not optimized for Hyper-Threading Technology). ><: Select Screen ↑↓: Select Item Enter: Select +/-: Change Opt. F1: General Help F2: Previous Values F3: Optimized Defaults F4: Save & Exit ESC: Exit
EMT64	Supported	
Processor Speed	1865 MHz	
System Bus Speed	533 MHz	
Processor Stepping	030661h (B2 Stepping)	
Microcode Revision	010Dh	
L1 Cache RAM	2x56 k	
L2 Cache RAM	2x512 k	
Processor Core	Dual	
Hyper-Threading	Supported	
Hyper-Threading	[Enabled]	
Core-Multi Processing	[Enabled]	
Execute Disable Bit	[Enabled]	
Limit CPUID Maximum	[Disabled]	

Version 2.15.1227. Copyright (C) 2012 American Megatrends, Inc.

Feature	Options	Description
Hyper-Threading	Disabled Enabled	Enables/Disables the Intel® Hyper Threading Technology HTT
Core-Multi Processing	Disabled Enabled	Enables/Disables Core-Multi Processing mode
Execute Disable Bit	Disabled Enabled	XD can prevent certain classes of malicious buffer overflow attacks when combined with a supporting OS
Limit CPUID Maximum	Disabled Enabled	Disabled for Windows XP

Additional setup option for Cedarview-M (N2600/N2800)

Feature	Options	Description
Speedstep	Disabled Enabled	Enables/Disables Enhanced Intel® Speedstep Technology EIST

Miscellaneous

Aptio Setup Utility - Copyright (C) 2012 American Megatrends, Inc.

Advanced

<p>Miscellaneous Configuration</p> <ul style="list-style-type: none"> ▶ Watchdog ▶ Clock Control ▶ Lan Configuration ▶ Generic LPC Decode Ranges ▶ Smart Battery Configuration ▶ GPIO Configuration ▶ Onboard I2C Speed <p>S5 Eco [Disabled]</p> <p>Reset Button Behavior [Chipset Reset]_</p>	<p>Watchdog Configuration.</p> <hr/> <p>><: Select Screen ↑↓: Select Item Enter: Select +/-: Change Opt. F1: General Help F2: Previous Values F3: Optimized Defaults F4: Save & Exit ESC: Exit</p>
---	--

Version 2.15.1227. Copyright (C) 2012 American Megatrends, Inc.

Feature	Options	Description
S5 Eco	Disabled Enabled	Reduce supply current in Soft Off State S5 to less than 1mA. If enabled, power button is the only wakeup source in S5. See chapter S5 Eco for more details
Reset Button Behavior	Chipset Reset Power Cycle	Select the behavior of Reset Button. Select Power Cycle to hold the module in reset while reset button is pressed

Watchdog

Aptio Setup Utility - Copyright (C) 2011 American Megatrends, Inc.

Advanced

Watchdog Configuration. Auto-reload [Disabled] Global Lock [Disabled] Stage 1 Mode [Disabled]	Select Action for this Watchdog stage <hr/> ><: Select Screen ↑↓: Select Item Enter: Select +/-: Change Opt. F1: General Help F2: Previous Values F3: Optimized Defaults F4: Save & Exit ESC: Exit
--	---

Version 2.14.1219. Copyright (C) 2011 American Megatrends, Inc.

Feature	Options	Description
Auto-reload	Disabled Enabled	Enable automatic reload of watchdog timers on timeout
Global Lock	Disabled Enabled	If set to enabled, all Watchdog registers (except WD_KICK) become read only until the board is reset
Stage 1 Mode	Disabled Reset NMI SCI Delay WDT Signal only	Select Action for first Watchdog stage
- Assert WDT Signal	Disabled Enabled	Enable/Disable assertion of WDT signal to baseboard on stage timeout
- Stage 1 Timeout	1s 5s 10s 30s 1m 3m 10m 30m	Select Timeout value for first watchdog stage
Stage 2 Mode	Disabled Reset NMI SCI WDT Signal only	Select Action for second Watchdog stage
- Assert WDT Signal	Disabled Enabled	Enable/Disable assertion of WDT signal to baseboard on stage timeout
- Stage 2 Timeout	1s 5s 10s 30s 1m 3m 10m 30m	Select Timeout value for second watchdog stage

Clock Control

Aptio Setup Utility - Copyright (C) 2011 American Megatrends, Inc.

Advanced

<p>Clock Control</p> <p>Spread Spectrum [- 0.50% Spread] LCD Spread Spectrum [Disabled]</p>	<p>Enabled/Disable Spread Spectrum for LCD.</p> <hr/> <p>><: Select Screen ↑↓: Select Item Enter: Select +/-: Change Opt. F1: General Help F2: Previous Values F3: Optimized Defaults F4: Save & Exit ESC: Exit</p>
---	---

Version 2.14.1219. Copyright (C) 2011 American Megatrends, Inc.

Feature	Options	Description
Spread Spectrum	Disabled -0.50% Spread	Enable/Disable Spread Spectrum for CPU, DMI, PCIe
LCD Spread Spectrum	Disabled -2.50 Spread	Enable/Disable Spread Spectrum for LCD

LAN Configuration

Aptio Setup Utility - Copyright (C) 2011 American Megatrends, Inc.

Advanced

<pre> Lan Configuration Onboard Lan Controlle [Enabled] Network OpROMs [Addon cards only] </pre>	<pre> Enable/Disable Onboard Lan Controller </pre> <hr/> <pre> ><: Select Screen ↑↓: Select Item Enter: Select +/-: Change Opt. F1: General Help F2: Previous Values F3: Optimized Defaults F4: Save & Exit ESC: Exit </pre>
---	--

Version 2.14.1219. Copyright (C) 2011 American Megatrends, Inc.

Feature	Options	Description
Onboard LAN Controller	Enabled Disabled	Enable/Disable onboard LAN Controller
Network OpROMs	Disabled Onboard only Addon cards only Both	Enable/Disable Legacy Boot Option for Network Devices

Generic LPC Decode Ranges

Aptio Setup Utility - Copyright (C) 2011 American Megatrends, Inc.

Advanced

<p>Generic LPC Decode Ranges</p> <p>Generic LPC Decode 1 [Disabled]</p> <p style="text-align: center;">-</p>	<p>Enable generic LPC decode range.</p> <hr/> <p>><: Select Screen ↑↓: Select Item Enter: Select +/-: Change Opt. F1: General Help F2: Previous Values F3: Optimized Defaults F4: Save & Exit ESC: Exit</p>
---	---

Version 2.14.1219. Copyright (C) 2011 American Megatrends, Inc.

Feature	Options	Description
Generic LPC Decode Range 1 Generic LPC Decode Range 2 Generic LPC Decode Range 3	Enabled Disabled	Enable/Disable Generic LPC Decode Range
Base Address	0100h	Base address of the generic decode range. Valid between 0100h - FFF0h. Must be 8-byte aligned.
Length	0008h	Length of the generic decode range. Valid between 0008h - 0100h. Must be multiple of 8.

Smart Battery Configuration

Aptio Setup Utility - Copyright (C) 2011 American Megatrends, Inc.

Advanced

<p>Smart Battery Configuration</p> <p>M.A.R.S. [Auto] System Type : N/A Power Source : Unknown Connected Batteries : 0</p> <ul style="list-style-type: none"> ▶ Battery #1 (slot empty) ▶ Battery #2 (slot empty) ▶ Battery #3 (slot empty) ▶ Battery #4 (slot empty) <p style="text-align: center;">-</p>	<p>Preset M.A.R.S. Smart Battery System mode. System must be restarted to reflect mode changes.</p> <hr/> <p>><: Select Screen ↑↓: Select Item Enter: Select +/-: Change Opt. F1: General Help F2: Previous Values F3: Optimized Defaults F4: Save & Exit ESC: Exit</p>
--	---

Version 2.14.1219. Copyright (C) 2011 American Megatrends, Inc.

Feature	Options	Description
M.A.R.S.	Disabled AUTO Charger Manager	Preset M.A.R.S. Smart Battery System mode. System must be restarted to reflect mode changes

Battery Information

Aptio Setup Utility - Copyright (C) 2011 American Megatrends, Inc.

Advanced

Battery #1 (slot empty)	
State	: N/A
Manufacturer	: N/A
Serial Number	: N/A
Device Name	: N/A
Chemistry	: N/A
Rel. State of Charge	: N/A
Cycle Count	: N/A
Date Of Manufacturing	: N/A
Charge Time	: N/A
Discharge Time	: N/A
Temperature	: N/A
Device Capacity	: N/A
Last Full Capacity	: N/A
Battery Voltage	: N/A
Current On Terminals	: N/A

><: Select Screen
 ↑↓: Select Item
 Enter: Select
 +/-: Change Opt.
 F1: General Help
 F2: Previous Values
 F3: Optimized Defaults
 F4: Save & Exit
 ESC: Exit

Version 2.14.1219. Copyright (C) 2011 American Megatrends, Inc.

GPIO Configuration

Aptio Setup Utility - Copyright (C) 2012 American Megatrends, Inc.

Advanced

GPIO Configuration	High / Low
GPI0 Level	[High]
GPI1 Level	[High]
GPI2 Level	[High]
GPI3 Level	[High]
GP00 Level	[Low]
GP01 Level	[Low]
GP02 Level	[Low]
GP03 Level	[Low]

><: Select Screen
 ↑↓: Select Item
 Enter: Select
 +/-: Change Opt.
 F1: General Help
 F2: Previous Values
 F3: Optimized Defaults
 F4: Save & Exit
 ESC: Exit

Version 2.15.1227. Copyright (C) 2012 American Megatrends, Inc.

Feature	Options	Description
GP00 Level	High	Set GP0 Level High/Low
GP01 Level	Low	
GP02 Level		
GP03 Level		

Onboard I2C Speed

Aptio Setup Utility - Copyright (C) 2011 American Megatrends, Inc.

Advanced

<p>Onboard I2C Bus Configuration</p> <p>Onboard I2C Speed [400kHz]</p>	<p>Select OnboardI2C Bus Speed in kHz, min. 1kHz, max. 400kHz</p> <hr/> <p>><: Select Screen ↑↓: Select Item Enter: Select +/-: Change Opt. F1: General Help F2: Previous Values F3: Optimized Defaults F4: Save & Exit ESC: Exit</p>
---	---

Version 2.14.1219. Copyright (C) 2011 American Megatrends, Inc.

Feature	Options	Description
Onboard I2C Speed	1kHz 10kHz 50kHz 100kHz 200kHz 400kHz	Select Onboard I2C Bus Speed in kHz, min 1kHz, max 400kHz

Thermal Configuration

```
Aptio Setup Utility - Copyright (C) 2011 American Megatrends, Inc.
  Advanced
Thermal Configuration
▶ CPU Thermal Configuration
▶ Platform Thermal Configuration

CPU Thermal
Configuration options

><: Select Screen
↑↓: Select Item
Enter: Select
+/-: Change Opt.
F1: General Help
F2: Previous Values
F3: Optimized Defaults
F4: Save & Exit
ESC: Exit

Version 2.14.1219. Copyright (C) 2011 American Megatrends, Inc.
```

CPU Thermal Configuration

Aptio Setup Utility - Copyright (C) 2011 American Megatrends, Inc.

Advanced

<p>Cpu Thermal Configuration</p> <p>DTS SMM [Enabled]</p>	<p>Thermal management uses DTS SMM mechanism to obtain CPU temperature values. Active/Passive Cooling is not working if disabled.</p> <hr/> <p>><: Select Screen ↑↓: Select Item Enter: Select +/-: Change Opt. F1: General Help F2: Previous Values F3: Optimized Defaults F4: Save & Exit ESC: Exit</p>
--	---

Version 2.14.1219. Copyright (C) 2011 American Megatrends, Inc.

Feature	Options	Description
DTS SMM	Disabled Enabled	Thermal management uses DTS SMM mechanism to obtain CPU temperature values. Active/Passive Cooling is not working if disabled

Platform Thermal Configuration

Aptio Setup Utility - Copyright (C) 2011 American Megatrends, Inc.

Advanced

Platform Thermal Configuration Critical Trip Point [POR]	This value controls the temperature of the ACPI Critical Trip Point - the point in which the OS will shut the system off. NOTE: 100C is the Plan Of Record (POR) for all Intel mobile processors.
--	--

><: Select Screen
 ↑↓: Select Item
 Enter: Select
 +/-: Change Opt.
 F1: General Help
 F2: Previous Values
 F3: Optimized Defaults
 F4: Save & Exit
 ESC: Exit

Version 2.14.1219. Copyright (C) 2011 American Megatrends, Inc.

Feature	Options	Description
Critical Trip Point	POR 15 .. 127	This value controls the temperature of the ACPI Critical Trip Point - the point in which the OS will shut the system off. Note: 100C is the Plan Of Record (POR) for all Intel mobile processors

IDE Configuration

Aptio Setup Utility - Copyright (C) 2011 American Megatrends, Inc.

Advanced

SATA Port0	WDC WD1600AAJS (160.0	SATA Ports (0-3) Device Names if Present and Enabled.
SATA Port1	GLS85LS1004P C (4.0GB	
SATA Controller(s)	[Enabled]	
Configure SATA as	[AHCI]	
Port0 Speed Limit	[No Limit]	
Port1 Speed Limit	[No Limit]	
SATA Port 0	[Enabled]	
SATA Port 0 Hot P	[Disabled]	
SATA Port 1	[Enabled]	
SATA Port 1 Hot P	[Disabled]	

><: Select Screen
 ↑↓: Select Item
 Enter: Select
 +/-: Change Opt.
 F1: General Help
 F2: Previous Values
 F3: Optimized Defaults
 F4: Save & Exit
 ESC: Exit

Version 2.14.1219. Copyright (C) 2011 American Megatrends, Inc.

Feature	Options	Description
SATA Controller(s)	Disabled Enabled	Enable/Disable the SATA controller
Configure SATA as	IDE AHCI	Select a configuration for SATA controller
Port0 Speed Limitation Port1 Speed Limitation	No Limit GEN1 Rate GEN2 Rate	Select AHCI Speed Limit
SATA Port 0 SATA Port 1	Disabled Enabled	Enable/Disable the SATA Port
SATA Port 0 Hot Plug SATA Port 1 Hot Plug	Disabled Enabled	Enable/Disable SATA Hot Plug Support

Intel Fast Flash Standby

Aptio Setup Utility - Copyright (C) 2012 American Megatrends, Inc.

Advanced

iFFS Support	[Enabled]	Enable or disable iFFS.
Enable Hibernation	Disabled	
ACPI Sleep State	S3 (Suspend to RAM)	
iFFS Partition is valid.		
Entry on S3 RTC Wake	[Enabled]	><: Select Screen ↑↓: Select Item Enter: Select +/-: Change Opt. F1: General Help F2: Previous Values F3: Optimized Defaults F4: Save & Exit ESC: Exit
Entry After	[Immediately]	

Version 2.15.1227. Copyright (C) 2012 American Megatrends, Inc.

Feature	Options	Description
iFFS	Disabled Enabled	Enable/Disable Intel Fast Flash Standby / Intel Rapid Start Technology
Entry on S3 RTC Wake	Disabled Enabled	iFFS invocation upon S3 RTC wake
Entry After	Immediately 1 minute 2 minutes 5 minutes 10 minutes 15 minutes 30 minutes 1 hour 2 hours	Enable RTC wake timer at S3 entry



Please read chapter Intel Fast Flash Standby before enabling

USB Configuration

Aptio Setup Utility - Copyright (C) 2012 American Megatrends, Inc.

Advanced

<pre> USB Configuration USB Devices: 1 Keyboard, 1 Mouse Legacy USB Support [Enabled] USB3.0 Support [Enabled] XHCI Hand-off [Enabled] EHCI Hand-off [Disabled] USB Beep [Disabled] USB hardware delays a USB transfer time-out [20 sec] Device reset time-out [20 sec] Device power-up delay [Auto]_ </pre>	<p>Enables Legacy USB support. AUTO option disables legacy support if no USB devices are connected. DISABLE option will keep USB devices available only for EFI applications.</p> <hr/> <p>><: Select Screen ↑↓: Select Item Enter: Select +/-: Change Opt. F1: General Help F2: Previous Values F3: Optimized Defaults F4: Save & Exit ESC: Exit</p>
--	---

Version 2.15.1227. Copyright (C) 2012 American Megatrends, Inc.

Feature	Options	Description
Legacy USB Support	Enabled Disabled AUTO	Enables Legacy USB support. AUTO option disables legacy support if no USB devices are connected. DISABLE option will keep USB devices available only for EFI applications.
USB3.0 Support	Enabled Disabled	Enable/Disable USB3.0 (xHCI) EFI support. Does not affect OS support.
XHCI Hand-off	Enabled Disabled	This is a workaround for OSes without XHCI hand-off Support. The XHCI ownership change should be claimed by XHCI driver
EHCI Hand-off	Enabled Disabled	This is a workaround for OSes without EHCI hand-off Support. The EHCI ownership change should be claimed by EHCI driver
USB Beep	Enabled Disabled	Send speaker beep for device attach / detach
USB transfer time-out	1sec 5sec 10sec 20sec	The time-out value for Control, Bulk and Interrupt transfers
Device reset time-out	10sec 20sec 30sec 40sec	USB mass storage device Start Unit command time-out
Device power-up delay	AUTO Manual	Maximum time the device will take before it properly reports itself to the Host controller. 'AUTO' uses default value: for a Root port it is 100ms, for a Hub port the delay is taken from Hub descriptor

SMART Settings

Aptio Setup Utility - Copyright (C) 2011 American Megatrends, Inc.

Advanced

SMART Settings		Run SMART Self Test on all HDDs during POST.
SMART Self Test	[Disabled]	

><: Select Screen
 ↑↓: Select Item
 Enter: Select
 +/-: Change Opt.
 F1: General Help
 F2: Previous Values
 F3: Optimized Defaults
 F4: Save & Exit
 ESC: Exit

Version 2.14.1219. Copyright (C) 2011 American Megatrends, Inc.

Feature	Options	Description
SMART Self Test	Disabled Enabled	Run SMART Self Test on all HDDs during POST

W83627H Super IO Configuration

This setup option is only available with LPC SuperI/O Nuvoton 83627 present on the baseboard. By default the COMe-cCT6 supports the legacy interfaces of a 5V 83627HF(J) or 3.3V 83627DHG-P on external LPC. The SIO hardware monitor is not supported in setup.

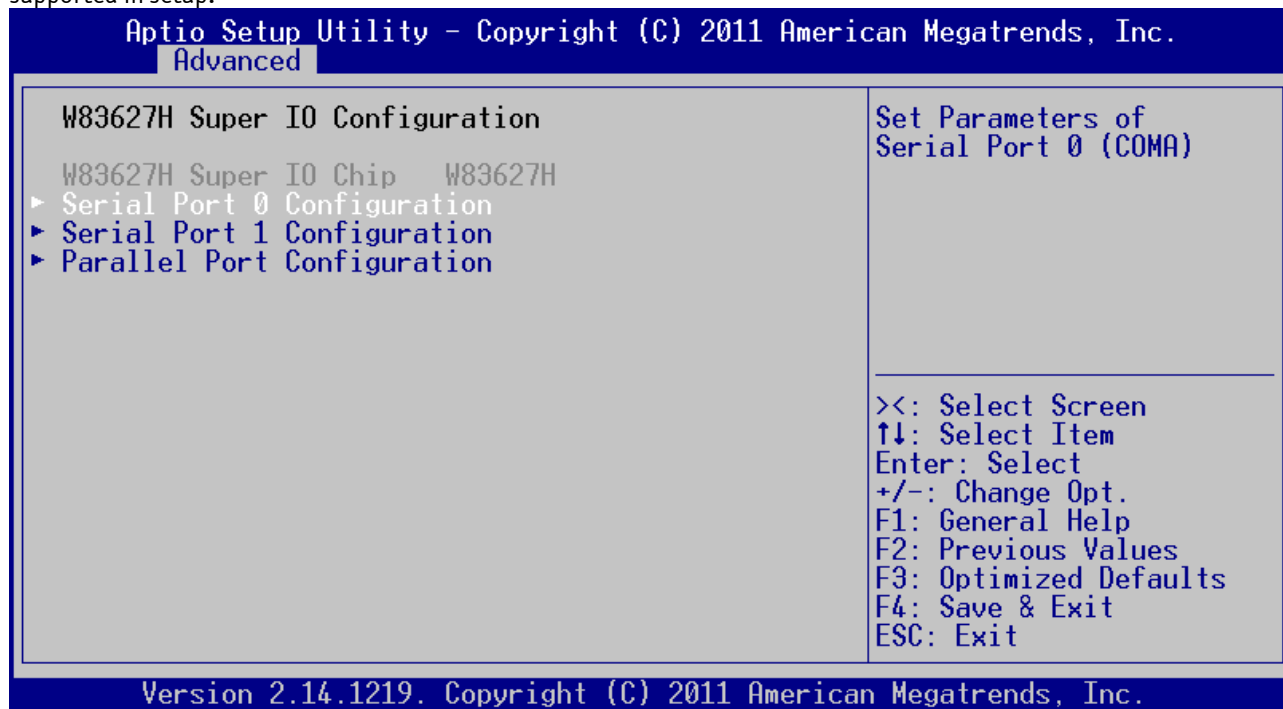

Serial Port 0 Configuration

Aptio Setup Utility - Copyright (C) 2011 American Megatrends, Inc.

Advanced

<p>Serial Port 0 Configuration</p> <p>Serial Port [Enabled] Device Settings IO=3F8h; IRQ=4;</p> <p>Change Settings [Auto]</p>	<p>Enable or Disable Serial Port (COM)</p> <hr/> <p>><: Select Screen ↑↓: Select Item Enter: Select +/-: Change Opt. F1: General Help F2: Previous Values F3: Optimized Defaults F4: Save & Exit ESC: Exit</p>
--	--

Version 2.14.1219. Copyright (C) 2011 American Megatrends, Inc.

Feature	Options	Description
Serial Port	Disabled Enabled	Enable or Disable Serial Port (COM) 0
Change Settings	AUTO IO=3F8h; IRQ=4; IO=3F8h, IRQ=3,4,5,6,7,9,10,11,12; IO=2F8h, IRQ=3,4,5,6,7,9,10,11,12; IO=3E8h, IRQ=3,4,5,6,7,9,10,11,12; IO=2E8h, IRQ=3,4,5,6,7,9,10,11,12;	Select an optimal setting for SuperIO device.
Device Mode	Standard Serial Port Mode IrDA 1.0 (HP SIR) Mode ASKIR Mode	Change the Serial Port mode.

Serial Port 1 Configuration

Aptio Setup Utility - Copyright (C) 2011 American Megatrends, Inc.

Advanced

<p>Serial Port 1 Configuration</p> <p>Serial Port [Enabled] Device Settings IO=2F8h; IRQ=3;</p> <p>Change Settings [Auto]</p>	<p>Enable or Disable Serial Port (COM)</p> <hr/> <p>><: Select Screen ↑↓: Select Item Enter: Select +/-: Change Opt. F1: General Help F2: Previous Values F3: Optimized Defaults F4: Save & Exit ESC: Exit</p>
--	--

Version 2.14.1219. Copyright (C) 2011 American Megatrends, Inc.

Feature	Options	Description
Serial Port	Disabled Enabled	Enable or Disable Serial Port (COM) 1
Change Settings	AUTO IO=2F8h; IRQ=3; IO=3F8h, IRQ=3,4,5,6,7,9,10,11,12; IO=2F8h, IRQ=3,4,5,6,7,9,10,11,12; IO=3E8h, IRQ=3,4,5,6,7,9,10,11,12; IO=2E8h, IRQ=3,4,5,6,7,9,10,11,12;	Select an optimal setting for SuperIO device.
Device Mode	Standard Serial Port Mode IrDA 1.0 (HP SIR) Mode ASKIR Mode	Change the Serial Port mode.

Parallel Port Configuration

Aptio Setup Utility - Copyright (C) 2011 American Megatrends, Inc.

Advanced

Parallel Port Configuration		Enable or Disable Parallel Port (LPT/LPTE)
Parallel Port Device Settings	[Enabled] IO=378h; IRQ=5;	
Change Settings Device Mode	[Auto] [STD Printer Mode]	
		><: Select Screen ↑↓: Select Item Enter: Select +/-: Change Opt. F1: General Help F2: Previous Values F3: Optimized Defaults F4: Save & Exit ESC: Exit

Version 2.14.1219. Copyright (C) 2011 American Megatrends, Inc.

Feature	Options	Description
Parallel Port	Disabled Enabled	Enable or Disable the Parallel Port (LPT/LPTE)
Change Settings	AUTO IO=378h; IRQ=5; IO=378h, IRQ=5,6,7,9,10,11,12; IO=278h, IRQ=5,6,7,9,10,11,12; IO=3BCh, IRQ=5,6,7,9,10,11,12; IO=378h; IO=278h; IO=3BCh;	Select an optimal setting for SuperIO device.
Device Mode	STD Printer Mode EPP Mode ECP Mode EPP Mode & ECP Mode	Change the Printer Port mode.

Module COM port Configuration

This setup option is only available with UART Option.

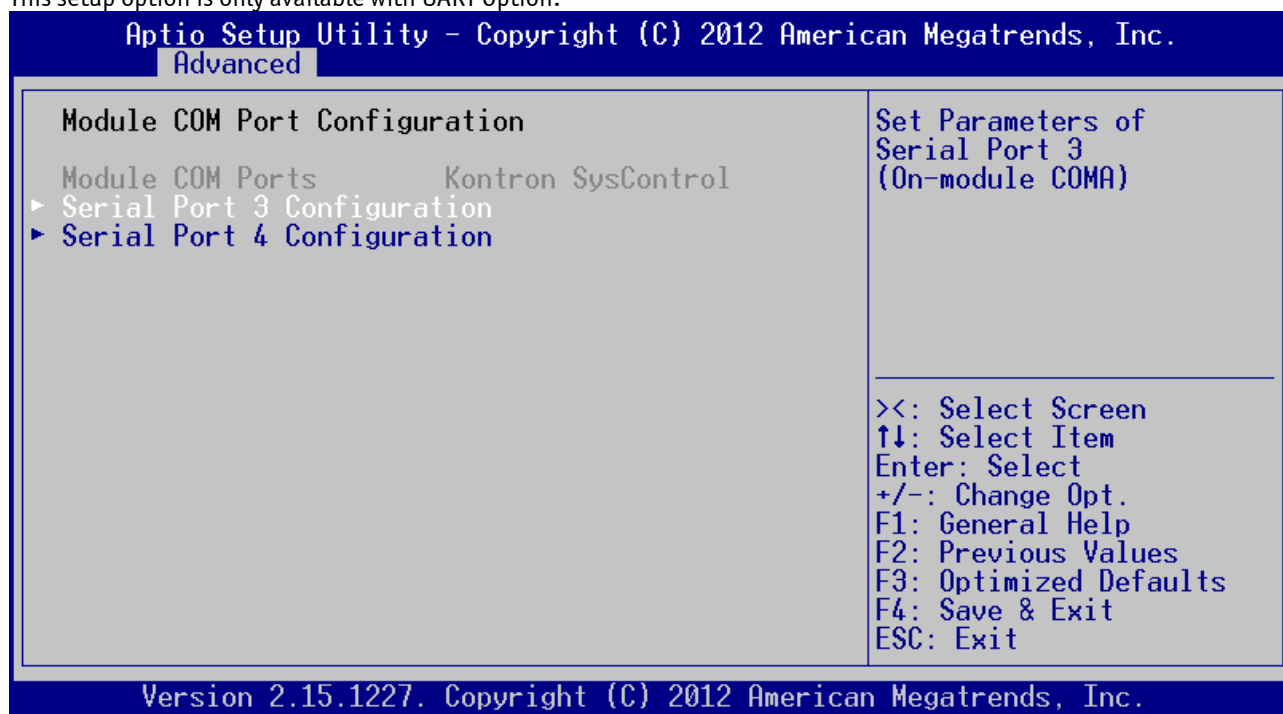

Serial Port 3 Configuration

Aptio Setup Utility - Copyright (C) 2012 American Megatrends, Inc.

Advanced

<p>Serial Port 3 Configuration</p> <p>Serial Port [Enabled] Device Settings IO=3F8h; IRQ=4;</p> <p>Change Settings [Auto]</p>	<p>Enable or disable module based Serial Port (COMx)</p> <hr/> <p>><: Select Screen ↑↓: Select Item Enter: Select +/-: Change Opt. F1: General Help F2: Previous Values F3: Optimized Defaults F4: Save & Exit ESC: Exit</p>
--	--

Version 2.15.1227. Copyright (C) 2012 American Megatrends, Inc.

Feature	Options	Description
Serial Port	Disabled Enabled	Enable or disable module based Serial Port (COMx)
Change Settings	Auto IO=3F8h; IRQ=4; IO=3F8h; IRQ=3,4,5,6,7,10,11,12; IO=2F8h; IRQ=3,4,5,6,7,10,11,12; IO=3E8h; IRQ=3,4,5,6,7,10,11,12; IO=2E8h; IRQ=3,4,5,6,7,10,11,12; \	Select an optimal setting

Serial Port 4 Configuration

Aptio Setup Utility - Copyright (C) 2012 American Megatrends, Inc.

Advanced

<p>Serial Port 4 Configuration</p> <p>Serial Port [Enabled] Device Settings IO=2F8h; IRQ=3;</p> <p>Change Settings [Auto]</p>	<p>Enable or disable module based Serial Port (COMx)</p> <hr/> <p>><: Select Screen ↑↓: Select Item Enter: Select +/-: Change Opt. F1: General Help F2: Previous Values F3: Optimized Defaults F4: Save & Exit ESC: Exit</p>
--	--

Version 2.15.1227. Copyright (C) 2012 American Megatrends, Inc.

Feature	Options	Description
Serial Port	Disabled Enabled	Enable or disable module based Serial Port (COMx)
Change Settings	Auto IO=3F8h; IRQ=4; IO=3F8h; IRQ=3,4,5,6,7,10,11,12; IO=2F8h; IRQ=3,4,5,6,7,10,11,12; IO=3E8h; IRQ=3,4,5,6,7,10,11,12; IO=2E8h; IRQ=3,4,5,6,7,10,11,12; \	Select an optimal setting

H/W Monitor

Aptio Setup Utility - Copyright (C) 2011 American Megatrends, Inc.

Advanced

H/W Monitor NCT7802Y		▲ Number of pulses the fan produces during one revolution. Range: 1-4 ><: Select Screen ↑↓: Select Item Enter: Select +/-: Change Opt. F1: General Help F2: Previous Values F3: Optimized Defaults F4: Save & Exit ESC: Exit ▼
CPU (DTS)	: 47 C	
PCB (LTD)	: 38 C	
CPU Fan	: 2662 RPM	
Fan Pulse	2	
Fan Control	[Auto]	
Fan Trip Point	50	
Trip Point Speed	50	
External Fan	: N/A	
Fan Pulse	2	
Fan Control	[Auto]	
Fan Trip Point	50	
Trip Point Speed	50	
3.3V	: 3.33 V	
VBat	: 2.69 V	
VCC	: 11.75 V	
5V Standby	: 5.02 V	

Version 2.14.1219. Copyright (C) 2011 American Megatrends, Inc.

Feature	Options	Description
CPU (DTS)	xx°C	Shows the calculated temperature of Tcasemax - Digital Thermal Sensor
PCB (LTD)	xx°C	Shows the internal hardwaremonitor temperature
CPU FAN	xxxx RPM	Shows the fan speed of onboard FAN connector
- CPU Fan Pulse	1 2 3 4	Select the number of pulses the CPU fan produces during one revolution
- FAN Control	Disabled Manual Auto	Set fan control mode
- FAN Trip Point	20 ... 50 ... 80	CPU Temperature where onboard fan starts
- Trip Point Speed	30 ... 50 ... 100	FAN speed at trip point in %. Minimum is 30%. Fan always runs at 100% at TJmax - 10C
- FAN Speed	30 ... 50 ... 100	Manual Fan Speed in % in manual mode. Minimum is 30%
External FAN	xxxx RPM	Shows the fan speed of external COMe FAN
- CPU Fan Pulse	1 2 3 4	Select the number of pulses the CPU fan produces during one revolution
- FAN Control	Disabled Manual Auto	Set fan control mode
- FAN Trip Point	20 ... 50 ... 80	CPU Temperature where onboard fan starts
- Trip Point Speed	30 ... 50 ... 100	FAN speed at trip point in %. Minimum is 30%. Fan always runs at 100% at TJmax - 10C
- FAN Speed	30 ... 50 ... 100	Manual Fan Speed in % in manual mode. Minimum is 30%
3.3V	x.xx V	Shows the onboard 3.3V supply voltage
VBAT	x.xx V	Shows the RTC Battery Voltage at the COMe Connector
VCC	x.xx V	Shows the Module Main Input Voltage
5.0V Standby	x.xx V	Shows the 5V Standby Voltage

Serial Port Console Redirection

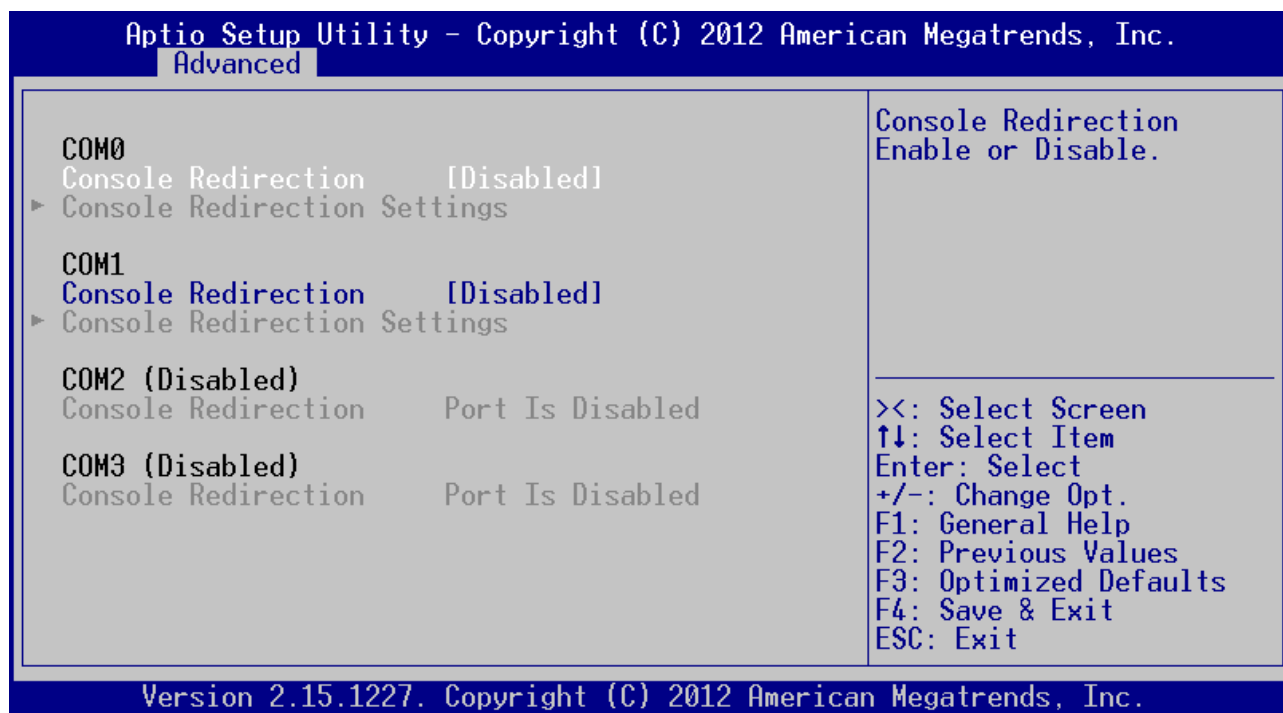

Screenshot shows configuration with onboard UART option but without external SIO

Feature	Options	Description
Console Redirection	Disabled Enabled	Enable/Disable Serial Port COM0 Console Redirection
Console Redirection	Disabled Enabled	Enable/Disable Serial Port COM1 Console Redirection
Console Redirection	Disabled Enabled	Enable/Disable Serial Port COM2 Console Redirection
Console Redirection	Disabled Enabled	Enable/Disable Serial Port COM3 Console Redirection



Serial Port Console Redirection is not allowed to activate at more than one port simultaneously

COM Port allocation

Console Redirection Port	With onboard UART option	With external SIO	With onboard UART Option and external SIO
COM0	Onboard Serial Port 0 (SER0)	External SIO COM1	External SIO COM1
COM1	Onboard Serial Port 1 (SER1)	External SIO COM2	External SIO COM2
COM2	not available	not available	Onboard Serial Port 0 (SER0)
COM3	not available	not available	Onboard Serial Port 1 (SER1)

Console Redirection Settings

Aptio Setup Utility - Copyright (C) 2011 American Megatrends, Inc.

Advanced

COM0 Console Redirection Settings		Emulation: ANSI: Extended ASCII char set. VT100: ASCII char set. VT100+: Extends VT100 to support color, function keys, etc. VT-UTF8: Uses UTF8 encoding to map Unicode chars onto 1 or more
Terminal Type Bits per second Data Bits Parity Stop Bits Flow Control VT-UTF8 Combo Key Sup Recorder Mode Resolution 100x31 Legacy OS Redirection Putty KeyPad Redirection After BIO	[ANSI] [115200] [8] [None] [1] [None] [Enabled] [Disabled] [Disabled] [80x24] [VT100] [Always Enable]	

><: Select Screen
 ↑↓: Select Item
 Enter: Select
 +/-: Change Opt.
 F1: General Help
 F2: Previous Values
 F3: Optimized Defaults
 F4: Save & Exit
 ESC: Exit

Version 2.14.1219. Copyright (C) 2011 American Megatrends, Inc.

Feature	Options	Description
Terminal Type	VT100 VT100+ VT_UTF8 ANSI	VT100: ASCII char set. VT100+: Extends VT100 to support color, function keys, etc. VT-UTF8: Uses UTF8 encoding to map Unicode chars onto 1 or more bytes ANSI: Extended ASCII char set.
Bits per second	9600 19200 38400 57600 115200	Selects serial port transmission speed. The speed must be matched on the other side. Long or noisy lines may require lower speeds
Data Bits	7 8	Data Bits
Parity	None Even Odd Mark Space	A parity bit can be sent with the data bits to detect some transmission errors. Even: parity bit is 0 if the num of 1's in the data bits is even. Odd: parity bit is 0 if num of 1's in the data bits is odd. Mark: parity bit is always 1. Space: Parity bit is always 0. Mark and Space Parity do not allow for error detection.
Stop Bits	1 2	Stop Bits indicate the end of a serial data packet. (A Start bit indicates the beginning). The standard setting is 1 stop bit. Communication with slow devices may require more than 1 stop bit.
Flow Control	None Hardware RTS/CTS	Flow control can prevent data loss from buffer overflow. When sending data, if the receiving buffers are full, a 'stop' signal can be sent to stop the data flow. Once the buffers are empty, a 'start' signal can be sent to restart the flow. Hardware flow control uses two wires to send start/stop signals
Recorder Mode	Disabled Enabled	With this mode enabled only text will be sent. This is to capture terminal data.
Resolution 100x31	Disabled Enabled	Enables or disables extended terminal resolution
Legacy OS Redirection Resolution	80x24 80x25	On Legacy OS, the Number of Rows and Columns supported redirection

8.5.3 Chipset

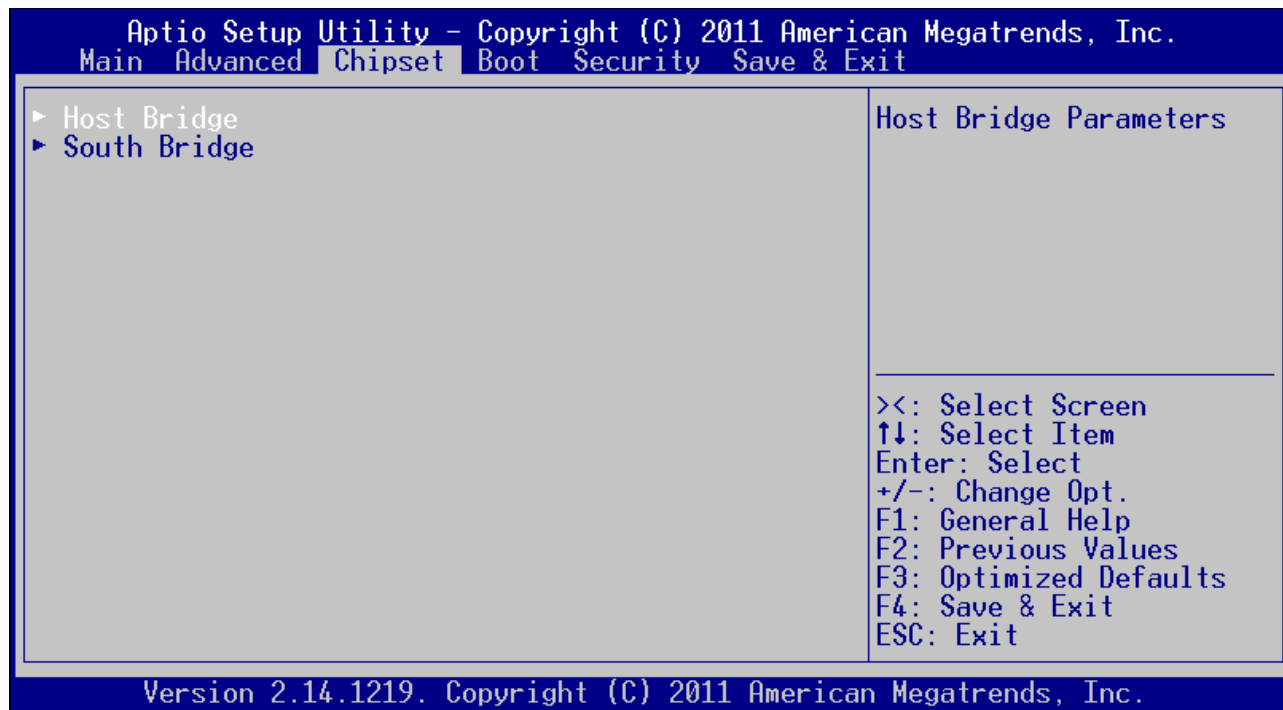

Host Bridge

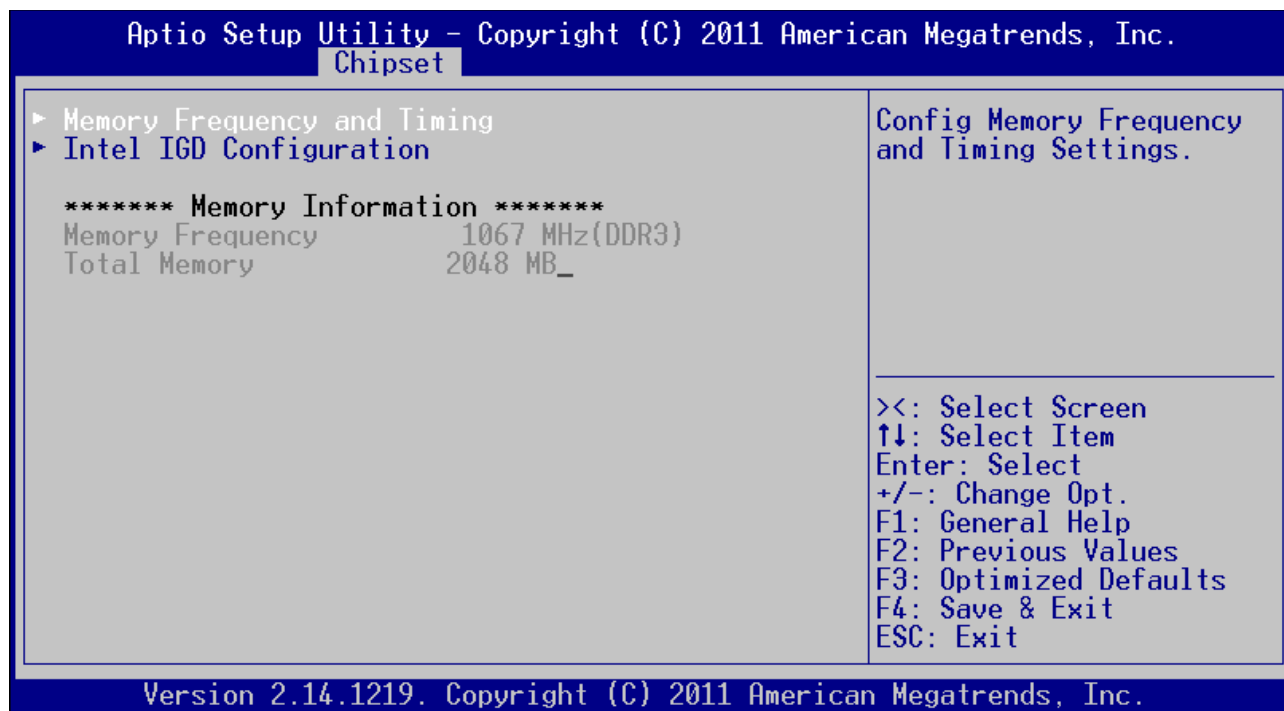

Memory Frequency and Timing

Aptio Setup Utility - Copyright (C) 2011 American Megatrends, Inc.

Chipset

Memory Frequency and Timing MRC Fast Boot [Enabled] Max TOLUD [Dynamic]	Enable or disable MRC fast boot. ><: Select Screen ↑↓: Select Item Enter: Select +/-: Change Opt. F1: General Help F2: Previous Values F3: Optimized Defaults F4: Save & Exit ESC: Exit
--	--

Version 2.14.1219. Copyright (C) 2011 American Megatrends, Inc.

Feature	Options	Description
MRC Fast Boot	Disabled Enabled	Enable/Disable MRC fast boot
Max TOLUD	Dynamic 1GB 1.25GB 1.5GB 1.75GB 2GB 2.25GB 2.5GB 2.75GB 3GB 3.25GB	Maximum Value of TOLUD. Dynamic assignment would adjust TOLUD automatically based on largest MMIO length of installed graphic controller

Intel IGD Configuration

Aptio Setup Utility - Copyright (C) 2012 American Megatrends, Inc.
Chipset

Intel IGD Configuration		▲ Select the Integrated Graphics Video Device which will be activated during POST. This has no effect if external graphics devices are present. ><: Select Screen ↑↓: Select Item Enter: Select +/-: Change Opt. F1: General Help F2: Previous Values F3: Optimized Defaults F4: Save & Exit ESC: Exit ▼
LVDS EEPROM Data		
Data Format	Fixed	
Resolution	800x480	
Color Depth	18Bit	
Channel Count	Single Channel	
Prim IGFX Boot Disp	[AUTO]	
Backlight Control	[I2C]	
Backlight Value	128	
embedded DP	[Disabled]	
EFP1 Type	[DP with HDMI/DVI]	
EFP2 Type	[DP with HDMI/DVI]	
Mode Persistence	[Disabled]	
Fixed Graphics Memory	[128MB]	

Version 2.15.1227. Copyright (C) 2012 American Megatrends, Inc.

Feature	Options	Description
Prim IGFX Boot Display	AUTO LVDS EFP1	Select the Integrated Graphics Video Device which will be activated during POST. This has no effect if external graphics devices are present.
Sec IGFX Boot Display	Disabled LVDS EFP1	Select Secondary Integrated Graphics Display Device
Int. LVDS Panel Type	AUTO VGA 640x480 1x18 WVGA 800x480 1x18 SVGA 800x600 1x18 XGA 1024x768 1x18 XGA 1024x768 1x24 WXGA 1280x1024 1x18 WXGA 1280x1024 1x24 WXGA 1280x800 1x18 WXGA 1366x768 1x18 WXGA 1366x768 1x24 WXGA+ 1440x900 1x18 WXGA+ 1440x900 1x24	Select LCD panel used by Internal Graphics Device by selecting the appropriate setup item
Panel Color Depth	18 Bit 24 Bit	For internal LVDS EDID detection, select the Panel Color Depth
Backlight Control	None/External PWM PWM Inverted I2C	Backlight Control Setting
Backlight Value	128	Set LCD backlight brightness (0-255)
embedded DP	Disabled Enabled	Enables the embedded Display Port device
EFP1 Type	DisplayPort Only DP with HDMI/DVI DP with DVI HDMI/DVI	Integrated HDMI/DP Configuration. Please select the Display Type the DDI is used for
EFP2 Type	DisplayPort Only DP with HDMI/DVI DP with DVI HDMI/DVI	Integrated HDMI/DP Configuration. Please select the Display Type the DDI is used for
Mode Persistence	Disabled Enabled	Enables/Disables Mode Persistence
Fixed Graphics Memory	128MB 256MB	Configure Fixed Graphics Memory Size

South Bridge

Aptio Setup Utility - Copyright (C) 2011 American Megatrends, Inc.

Chipset

<p>▶ TPT Devices</p> <p>PCI ExpressCard 0 [Disabled] PCI ExpressCard 1 [Disabled]</p> <p>▶ PCI Express Root Port 0 ▶ PCI Express Root Port 1 ▶ PCI Express Root Port 2 ▶ PCI Express Root Port 3 - GbE</p> <p>DMI Link ASPM Control [Enabled] PCI-Exp. High Priorit [Disabled]</p> <p>High Precision Event Timer Configuration High Precision Timer [Enabled]</p> <p>SLP_S4 Assertion Widt [1-2 Seconds] Restore AC Power Loss [Power On]_</p>	<p>Enable/Disable Intel(R) IO Controller Hub (TPT) devices</p> <hr/> <p>><: Select Screen ↑↓: Select Item Enter: Select +/-: Change Opt. F1: General Help F2: Previous Values F3: Optimized Defaults F4: Save & Exit ESC: Exit</p>
--	--

Version 2.14.1219. Copyright (C) 2011 American Megatrends, Inc.

Feature	Options	Description
PCIe ExpressCard0	Port 0 Port 1 Port 2 Port 3 Disabled	Controls PCIe Port for ExpressCard support
PCIe ExpressCard1	Port 0 Port 1 Port 2 Port 3 Disabled	Controls PCIe Port for ExpressCard support
DMI Link ASPM Control	Disabled Enabled	The control of Active State Power Management on both NB side and SB side of the DMI Link
PCIe ExpressCard0	Disabled Port 0 Port 1 Port 2 Port 3	Select a PCI Express High Priority Port
PCI-Exp. High Priority Port	Disabled Enabled	Enable or Disable PCI Express Clock Gating for each root port
High Precision Timer	Disabled Enabled	Enable or Disable the High Precision Event Timer
SLP_S4 Assertion Width	Disabled 1-2 Seconds 2-3 Seconds 3-4 Seconds 4-5 Seconds	Select a minimum assertion width of the SLP_S4# signal
Restore AC Power Loss	Power Off Power On Last State	Select AC power state when power is re-applied after a power failure

TPT (Tigerpoint IO Hub) Devices

Aptio Setup Utility - Copyright (C) 2011 American Megatrends, Inc.

Chipset

Azalia Controller	[HD Audio]	Azalia Controller
Azalia PME Enable	[Disabled]	
Azalia Vci Enable	[Enabled]	
USB Function	[8 USB Ports]	
USB 2.0(EHCI) Support	[Enabled]	
SMBus Controller	[Enabled]	
SIRQ Logic	[Enabled]	><: Select Screen ↑↓: Select Item Enter: Select +/-: Change Opt. F1: General Help F2: Previous Values F3: Optimized Defaults F4: Save & Exit ESC: Exit
SIRQ Mode	[Continous]	

Version 2.14.1219. Copyright (C) 2011 American Megatrends, Inc.

Feature	Options	Description
Azalia Controller	Disabled HD Audio	Enable/Disable the HD Audio Controller
Azalia PME Enable	Disabled Enabled	Enable/Disable Power Management capability of Audio Controller
Azalia Vci Enable	Disabled Enabled	Azalia supports 1 extended VC, which, when enabled, overrides ICH VcP settings
USB Function	Disabled 2 USB Ports 4 USB Ports 6 USB Ports 8 USB Ports	Enable/Disable USB Function
USB 2.0 (EHCI) Support	Disabled Enabled	Enable/Disable USB 2.0 (EHCI) Support
SMBus Controller	Disabled Enabled	Enable/Disable OnChip SMBus Controller. If disabled, H/W Monitor, Active Cooling and Smart Battery is no longer working!
SIRQ Logic	Disabled Enabled	Enable/Disable SIRQ Logic
SIRQ Mode	Quiet Continous	Set SIRQ mode

PCI Express Root Port 0/1/2/3

Aptio Setup Utility - Copyright (C) 2012 American Megatrends, Inc.			
Chipset			
PCI Express Port 0	[Enabled]	Enable / Disable PCI Express Root Port 0.	
Port 0 IOxAPIC	[Disabled]		
Automatic ASPM	[Manual]		
ASPM L0s	[Disabled]		
ASPM L1	[Disabled]		
URR	[Disabled]		
FER	[Disabled]		
NFER	[Disabled]		
CER	[Disabled]		
CTO	[Disabled]		
SEFE	[Disabled]	><: Select Screen ↑↓: Select Item Enter: Select +/-: Change Opt. F1: General Help F2: Previous Values F3: Optimized Defaults F4: Save & Exit ESC: Exit_	
SENFE	[Disabled]		
SECE	[Disabled]		
PME SCI	[Enabled]		
Hot Plug	[Disabled]		
Extra Bus Reserved	0		
Reserved Memory	10		
Reserved I/O	4		
Version 2.15.1227. Copyright (C) 2012 American Megatrends, Inc.			

Feature	Options	Description
PCI Express Root Port	Disabled Enabled	Enable/Disable the PCI Express Root Port
Port x IOxAPIC	Disabled Enabled	Enable/Disable PCI Express Root Port I/O APIC
Automatic ASPM	Manual Auto	Automatically enable ASPM based on reported capabilities and known issues
ASPM L0s	Disabled Root Port Only Endpoint Port Only Both Root And Endpoint Ports	Enable PCIe ASPM L0s
ASPM L1	Disabled Enabled	Enable PCIe ASPM L1
URR	Disabled Enabled	Enable or Disable PCI Express Unsupported Request Reporting
FER	Disabled Enabled	Enable or Disable PCI Express Device Fatal Error Reporting
NFER	Disabled Enabled	Enable or Disable PCI Express Device Non-Fatal Error Reporting
CER	Disabled Enabled	Enable or Disable PCI Express Device Correctable Error Reporting
CTO	Disabled Enabled	Enable or Disable PCI Express Completion Timer Timeout
SEFE	Disabled Enabled	Enable or Disable Root PCI Express System Error on Fatal Error
SENFE	Disabled Enabled	Enable or Disable Root PCI Express System Error on Non-Fatal Error
SECE	Disabled Enabled	Enable or Disable Root PCI Express System Error on Correctable Error
PME SCI	Disabled Enabled	Enable or Disable PCI Express PME SCI
Hot Plug	Disabled Enabled	Enable or Disable PCI Express Hot Plug
Extra Bus Reserved	0	Extra Bus Reserved (0-7) for bridges behind this Root Bridge
Reserved Memory	10	Reserved Memory and Prefetchable Memory (1-20 MB) Range for this Root Bridge
Reserved I/O	4	Reserved I/O (4k/8k(12k/16k/20k) Range for this Root Bridge

8.5.4 Boot

```

Aptio Setup Utility - Copyright (C) 2011 American Megatrends, Inc.
Main Advanced Chipset Boot Security Save & Exit

Boot Configuration
Setup Prompt Timeout      1
Bootup NumLock State     [On]

Quiet Boot                [Disabled]
Fast Boot                 [Disabled]
New HDD Priority          [Low]

CSM16 Module Version     07.69

GateA20 Active           [Upon Request]
Option ROM Messages      [Force BIOS]
INT19 Trap Response      [Immediate]

Boot Option Priorities
Boot Option #1           [SATA  PM: WDC WD16...]
Boot Option #2           [SATA  SM: GLS85LS1...]
Boot Option #3           [UEFI: Built-in EFI...]

Number of seconds to wait for setup activation key.
65535(0xFFFF) means indefinite waiting.

><: Select Screen
↑↓: Select Item
Enter: Select
+/-: Change Opt.
F1: General Help
F2: Previous Values
F3: Optimized Defaults
F4: Save & Exit
ESC: Exit

Version 2.14.1219. Copyright (C) 2011 American Megatrends, Inc.

```

Feature	Options	Description
Setup Prompt Timeout	1	Number of seconds to wait for setup activation key. 65535 (0xFFFF) means indefinite waiting. 0 means no wait (not recommended)
Bootup NumLock State	On Off	Select the keyboard NumLock state
Quiet Boot	Disabled Enabled	Enables/Disables Quiet Boot option (Boot logo)
Fast Boot	Disabled Enabled	Enables/Disables boot with initialization of a minimal set of devices required to launch active boot option. Has no effect for BBS boot options.
New HDD Priority	Low High	Boot priority for new connected HDD
GateA20 Active	Upon Request Always	Upon Request: GA20 can be disabled using BIOS services. Always: do not allow disabling GA20; this option is useful when any RT code is executed above 1MB
Option ROM Messages	Force BIOS Keep Current	Set display mode for Option ROM
Interrupt 19 Capture	Disabled Enabled	Enabled: Allows Option ROMs to trap INT19
Boot Option #1 Boot Option #2 Boot Option #3 ...	Boot Device Disabled	Set the system boot order by device group

8.5.5 Security

Aptio Setup Utility - Copyright (C) 2011 American Megatrends, Inc.
 Main Advanced Chipset Boot Security Save & Exit

Password Description
 If ONLY the Administrator's password is set, then this only limits access to Setup and is only asked for when entering Setup.
 If ONLY the User's password is set, then this is a power on password and must be entered to boot or enter Setup. In Setup the User will have Administrator rights.
 The password length must be in the following range:
 Minimum length 3
 Maximum length 20

Administrator Password
 User Password

HDD Security Configur
 HDD0:WDC WD1600AA
 HDD1:GLS85LS1004P

Set Administrator Password
 ><: Select Screen
 ><: Select Screen
 ↑↓: Select Item
 Enter: Select
 +/-: Change Opt.
 F1: General Help
 F2: Previous Values
 F3: Optimized Defaults
 F4: Save & Exit
 ESC: Exit

Version 2.14.1219. Copyright (C) 2011 American Megatrends, Inc.

Feature	Options	Description
Administrator Password	-	Set the Administrator Password for Setup Access
User Password	-	Set User Password
HDDx	-	Set HDD Password

Set HDD Password

```

Aptio Setup Utility - Copyright (C) 2011 American Megatrends, Inc.
Security
HDD Password Description :
Allows Access to Set, Modify and Clear
HardDisk User and Master Passwords.
User Password need to be installed for
Enabling Security. Master Password can
be Modified only when successfully unlocked
with Master Password in POST.

HDD PASSWORD CONFIGURATION:
Security Supported          Yes
Security Enabled           No
Security Locked            No
Security Frozen            No
HDD User Pwd Status        NOT INSTALLED
HDD Master Pwd Status      INSTALLED

Set User Password

Set HDD User Password.
*** Advisable to Power
Cycle System after
Setting Hard Disk
Passwords ***

><: Select Screen
↑↓: Select Item
Enter: Select
+/-: Change Opt.
F1: General Help
F2: Previous Values
F3: Optimized Defaults
F4: Save & Exit
ESC: Exit
Version 2.14.1219. Copyright (C) 2011 American Megatrends, Inc.

```

Feature	Options	Description
Set User Password	-	Set HDD User Password. Advisable to Power Cycle System after Setting Hard Disk Passwords

8.5.6 Save & Exit

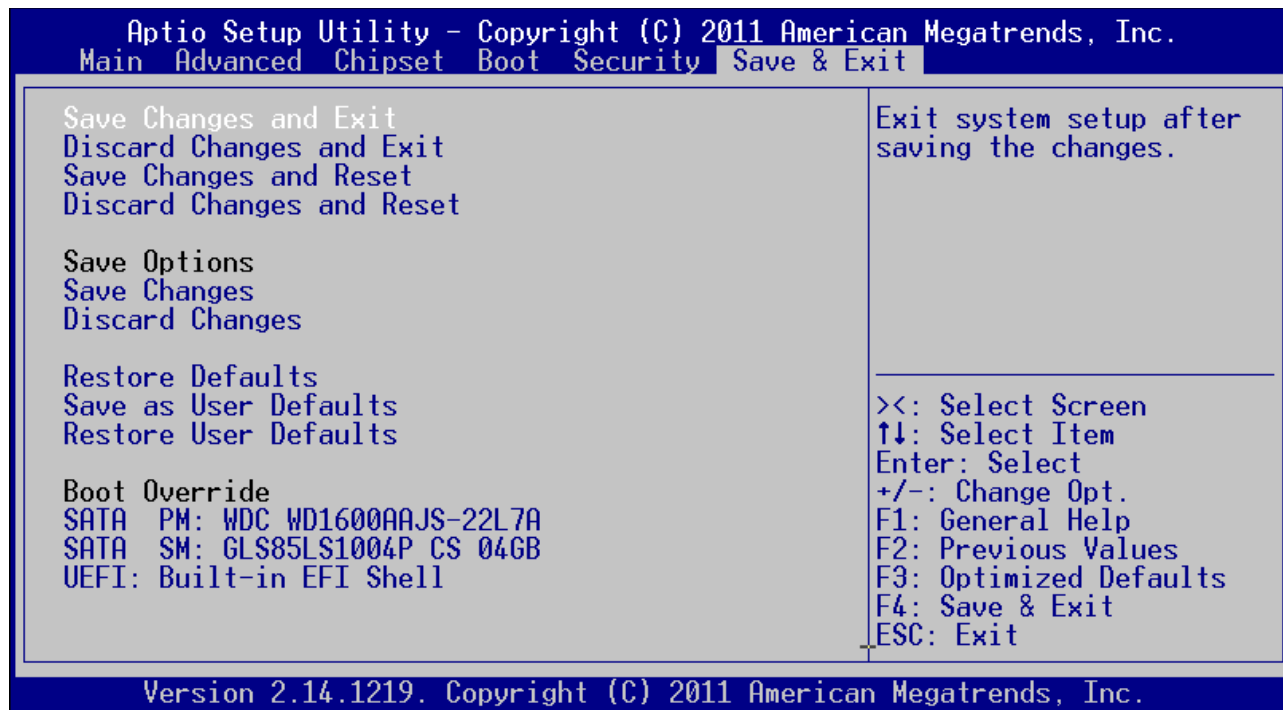

Feature	Options	Description
Save Changes and Exit	-	Exit system setup after saving the changes
Discard Changes and Exit	-	Exit system setup without saving any changes
Save Changes and Reset	-	Reset system after saving the changes
Discard Changes and Reset	-	Reset system without saving any changes
Save Changes	-	Save changes made so far to any of the setup options
Discard Changes	-	Discard changes made so far to any of the setup options
Restore Defaults	-	Restore/Load Default values for all the setup options
Save as User Defaults	-	Save the changes made so far as User Defaults
Restore User Defaults	-	Restore the User Defaults to all the setup options
Boot Override	List of all boot options	Boot directly from selected device

Corporate Offices

Europe, Middle East & Africa

Oskar-von-Miller-Str. 1
85386 Eching/Munich
Germany
Tel.: +49 (0)8165/ 77 777
Fax: +49 (0)8165/ 77 219
info@kontron.com

North America

14118 Stowe Drive
Poway, CA 92064-7147
USA
Tel.: +1 888 294 4558
Fax: +1 858 677 0898
info@us.kontron.com

Asia Pacific

17 Building, Block #1, ABP.
188 Southern West 4th Ring
Beijing 100070, P.R.China
Tel.: + 86 10 63751188
Fax: + 86 10 83682438
info@kontron.cn

